



MestReNova Manual

© 2013 MESTRELAB RESEARCH □

Last Revision: 9-Apr-2013

MestreNova 8.1.2

by MESTRELAB RESEARCH

This is the manual of MestreNova 8.1.2

MestreNova Manual

© 2013 MESTRELAB RESEARCH

All rights reserved. No parts of this work may be reproduced in any form or by any means - graphic, electronic, or mechanical, including photocopying, recording, taping, or information storage and retrieval systems - without the written permission of the publisher.

Products that are referred to in this document may be either trademarks and/or registered trademarks of the respective owners. The publisher and the author make no claim to these trademarks.

While every precaution has been taken in the preparation of this document, the publisher and the author assume no responsibility for errors or omissions, or for damages resulting from the use of information contained in this document or from the use of programs and source code that may accompany it. In no event shall the publisher and the author be liable for any loss of profit or any other commercial damage caused or alleged to have been caused directly or indirectly by this document.

Table of Contents

Part I Introduction	10
1 Formats supported.....	10
2 System Requirements.....	11
Windows System Requirements	11
Mac OS X System Requirements	11
Linux System Requirements	11
Part II Installation Guide	14
Part III Mnova 8.1	20
Part IV Shortcuts	24
Part V Fast Visual Guide to process routine 1D-NMR datasets	28
Part VI Fast Visual Guide to process routine 2D-NMR datasets	35
Part VII The Mnova interface	41
1 Multipage Software.....	42
2 Working on a Single Page.....	45
3 Mnova Menus & Toolbars.....	47
4 Intelligent NMR Clipboard.....	67
5 Properties	71
6 Preferences.....	85
7 Contextual Menus.....	92
8 Toolbars Customization.....	99
9 Localization.....	105
10 Layout Templates.....	107
11 How to measure coupling constants? The Crosshair Tool.....	113
Multiple Crosshair for 2D analysis	114
12 Zooming	117
Full View	124
Create Expansions	126
13 Cutting Spectra.....	127
14 Increasing and Decreasing Intensity.....	129
15 Undo & Redo.....	129

16	Graphics and Annotations.....	130
Part VIII Processing Basics		133
1	1D NMR Processing Tour.....	133
2	2D NMR Processing Tour.....	138
3	Stacked NMR Processing.....	146
	How to apply a peak picking or an integration analysis in stacked mode?	154
	Table of stacked spectra	156
	Stacked Options and Properties	163
4	Fourier Transform.....	170
	Group Delay	172
	FID Shift	176
	Diagonal Suppresion	177
	Signal Suppresion	179
	Apodization	181
	Truncation	192
	Zero Filling and Linear Prediction	193
	Drift Correction	196
	The FT Command	197
5	Phase Correction with Mnova.....	198
6	Baseline Correction with Mnova.....	207
7	Symmetrization.....	217
8	Tilt 45	218
9	Reducing t1 Noise.....	219
10	Covariance NMR.....	219
11	Normalization.....	230
12	Binning	231
13	Compression.....	232
14	Smoothing.....	233
15	Resolution Booster	236
16	Inverting, Transposing and Reversing Spectra.....	240
17	Processing Templates.....	240
Part IX Analysis Tools		244
1	Chemical Shift Referencing.....	244
	Absolute Reference of x-Nuclei experiments	247
	Reference of 2D-NMR spectra with the 1D external trace	249
2	Blind Regions.....	253
3	Peak Picking.....	255
	Peak Picking Options	260
	Impurities Auto detection.....	270
	GSD (Global Spectral Deconvolution)	273
	What else can I do with GSD?.....	283
	Peaks Table and Reports	286
	Peak Picking Properties	300

4	Integration	303
	Integrals Table	317
	Integral Properties	318
5	Multiplets analysis	320
	Multiplet Manager	322
	Using GSD for multiplets analysis	327
	Setting multiplets	333
	How to resolve overlapped multiplets?	335
	Multiplets Table and Reports	341
	Multiplet Analysis options	355
	Multiplets Properties	355
6	Mnova Verify	360
	Single Mode	361
	Options	371
	Troubleshooting a negative result	371
	Rank potential molecular candidates	375
	Verification in batch mode	380
7	Molecules Editor	391
	Molecular Structure	393
	Compounds Table.....	401
8	How to carry out assignments?	402
	Transferring assignments through datasets	420
	Assisted assignment by using the predictions	425
	Copy assignments from one molecule to another	427
	Assignments Properties	428
9	NMR Prediction	431
	Modgraph NMR Predict Desktop	432
	Running predictions.....	434
	Predict & Highlight.....	446
	Predict & Compare.....	450
	Predict & Verify.....	453
	Prediction Database.....	459
	3D Molecule Viewer.....	466
	Prediction Options.....	467
	NMRPredict Server-Based	469
10	Tables	473
Part X Advanced Menu		488
1	Line Fitting (Deconvolution)	488
	Line Fitting Properties	501
2	Bayesian DOSY Transform	502
3	Data Analysis Quick Start Guide	511
	Data Analysis	515
	Data Analysis panel	531
	Reaction Monitoring (R-M)	538
	Importing Datasets.....	538
	Selecting Regions.....	547
	RM Options.....	552
	Handling of Arrayed Spectra.....	553
	T1 Analysis	560

Data Analysis Properties	563
4 Reference Alignment.....	566
5 Align Spectra.....	567
6 J-Correlator.....	576
7 Arithmetic	578
8 Spin Simulation.....	584
Part XI qNMR	596
1 qNMR Workflow.....	597
2 qNMR Settings.....	602
3 Batch qNMR.....	608
4 Purity Calculator.....	613
Part XII Scripting with Mnova	621
1 Connecting scripts with Mnova objects.....	629
2 Connecting scripts with Mnova GUI.....	639
3 Mnova processing scripts.....	639
4 Mnova properties scripts.....	644
5 GUI Actions.....	646
6 Running Scripts from the command line.....	646
7 Import spectra.....	648
8 Export as ASCII.....	648
9 Scripts Samples.....	649
Part XIII Tutorials	667
1 Importing Spectrum Parameters.....	667
2 Basics on Arrayed-NMR Data Analysis.....	679
3 Superimposed Spectra.....	696
4 How to process Varian DEPT spectra?.....	698
5 Mnova for metabonomics.....	706
6 Show Traces in 2D-NMR.....	714
7 Manual Phase Correction in 2D-NMR.....	723
8 Pasting Spectra into Reports.....	727
9 How to predict a spectrum with NMRPredict Desktop?.....	733
Part XIV Mass Plugin	739
1 First Steps with the Mass Plugin.....	741
2 Working with the MS plugin.....	751
MS Browser	754
Mass Analysis	765
Peak Detection (Integration).....	766
Spectrum Selection Mode.....	767

Elemental Composition.....	774
Molecular Match.....	779
New Mass chromatogram.....	784
Reference External Traces.....	786
Background and UV subtraction.....	786
MS Peaks Table	788
Context menu	792
Properties	795
Preferences	806

Part XV Mnova Database 809

1 Create a Database.....	809
2 Connecting to the Server.....	809
3 Saving items to Database.....	810
4 Displaying database contents.....	816
Operations	816
Searching in the Database	817
5 View Results.....	838
6 Deleting items/Records.....	847
7 User Preferences.....	848
8 Managing Databases.....	853
Create custom fields	857
9 Mnova DB scripts.....	861

Part



1 Introduction

Welcome to **MestReNova (Mnova)**. **Mnova** is the latest Nuclear Magnetic Resonance and LC/GC/MS data processing, visualization, simulation, prediction, presentation and analysis software package available on the market. This **Help Manual** introduces you to this new software, ensuring that you can use it successfully and achieve good results right from the start. We strongly suggest that you print this manual and follow it when first using **Mnova**, as this will make your introduction to the software very simple and painless, and will make sure that you quickly identify all the main functionality in the software.

Mnova is the natural evolution of our very popular application **MestReC**. However, it is more than a new version of **MestReC**. Whilst including all the NMR processing and analysis functionality present in **MestReC**, it is a completely new development and a completely new concept which will open up a whole new range of possibilities when storing and sharing data within organizations, changing the way in which scientists process and report NMR and LC/GC/MS data. **Mnova** has been designed to make NMR and LC/GC/MS both more convenient and more powerful, and to give the user improved results with minimum effort.

The program provides a variety of **conversion facilities** for most NMR and LC/GC/MS spectrometer and chromatogram formats and includes all the conventional processing, displaying, and plotting capabilities of an NMR program, as well as more advanced processing techniques with a very easy-to-use and intuitive graphical interface. To read a little bit more on the main features, and familiarize yourself with the principles behind the program, follow this guide.

1.1 Formats supported

Here you can see a list of some of the main formats supported by **Mnova**:

NMR: Bruker Aspect 2000/3000, Bruker UXNMR/XWIN-NMR, Bruker WinNMR, GE/Nicolet, Galactic (*.spc), JEOL Alice (.als), JEOL Delta, JEOL EX/GX, JEOL Fastflight (.fft), JEOL Lambda (.nmfid, .nmdata, .nmf, .nmd), Magritek Prospa (*1D, *2D), Old Gemini, SIMPSON, Siemens Magnetom Vision, Tecmag (.tnt), Varian Gemini/VXR from VHelper, Varian VNMR, VARIAN/Chemagnetic Spinsight (data), Philips Achieva, Siemens Syngo.

Other NMR formats: ASCII (.txt), **Mnova** (.mnova), ZIP (.zip), **MestReC** (.mrc), NUTS Type 1-3, SwaN-MR, JCAMP-DX (.jcamp, .dx, .jdx, .jcm), ACD-Labs (1D), Int 32 WinNMR, LCMModel ASCII, Sparky 2D

MS: Currently supported formats on Windows
Agilent – ChemStation, MassHunter, Ion Trap
Bruker – Xmass, Compass[1] and Daltonics[1]
Waters – MassLynx
Thermo Scientific – Xcalibur
mzData and mzXML
JEOL – MSQ 1000, FastFlight
AB SCIEX – Analyst[1]
AB SCIEX Data Explorer
Shimadzu

NetCDF ANDI-MS

Currently supported formats on Mac / Linux

Agilent – ChemStation

Bruker – XMass

FSU – Midas

mzData and mzXML

Waters – MassLynx (Mac only)

[1] At present, Mnova MS supports Bruker Compass, Daltonics and Analyst files but it is necessary to have the vendor software installed on the same computer for this to work. We recommend to have installed Mnova on the spectrometer computer and export your MS datasets as .mnova format to use them in any other computer without the vendor software. For further information please email us to support@mestrelab.com

1.2 System Requirements

Before installation, please read this chapter. In this section you will find information on which hardware and software requirements must be met before you can install Mnova. In any case, it is worth noting that Mnova is a **multiplatform** software which will run alternatively on Windows, Mac OS X, Linux and Unix-like systems. From now on, multiplatform laboratories will be able to allow each researcher to work on their Operating System of choice, and to seamlessly share data and processing capabilities with other researchers working on different platforms. There is no longer a need to have three different software packages, and three different file formats, for different Operating Systems.

The minimum and recommended system requirements for the software are:

[Windows](#)

[Mac OS X](#)

[Linux](#)

1.2.1 Windows System Requirements

The *minimum* recommended configuration for Mnova installation is at least Pentium 300 MHz, 128MB RAM, a VGA color monitor with 800 x 600 pixels resolution, a compatible mouse and Windows XP as operating system. However, ideal system requirements for optimum operation of the software are Pentium 1,6 GHz or higher CPU with 512 Mb or more of RAM memory and Windows XP, Server 2003, Vista or Windows 7.

Mnova will not install under Windows 98 or lower. The default installation requires about 100 Mb of disk space.

If you are going to install (or uninstall) the program on a Windows XP system, be sure you have administrator privileges, because the installation procedure is going to install several files in your system folders. If you don't have such privileges, you won't be able to install or uninstall the program correctly.

1.2.2 Mac OS X System Requirements

Mnova requires at least Mac OS X 10.5 (Leopard), with Intel architecture. The current version of Mnova is also compatible with Mac OS X 10.6 (Snow Leopard) and 10.7 (Lion).

1.2.3 Linux System Requirements

Mnova requires at least Pentium 300 MHz, 128MB RAM, Video Adapter Super VGA (800 x 600) with X Library (Xlib). Please, make sure to choose the correct setup file for your Operating System (Debian Lenny, Debian Squeeze, OpenSUSE 10.1 and 11, Fedora 10 and 11, Ubuntu 8.04 and 9.04, Red Hat

Enterprise 4 or 5 and Mandriva 2007 and 2009)

Part



2 Installation Guide

Instructions to Install and Activate an Individual Copy of Mnova:

1. If you are going to install the program on a Windows XP system, be sure you have administrator privileges, because the installation procedure is going to install several files in your system folders. If you don't have such privileges, you won't be able to install or uninstall the program correctly.

2. On each host, download the Mnova SETUP file from our website at <http://mestrelab.com/software/mnova-suite/download/>. Then, double click on the Mnova SETUP file and follow the instructions as they appear on screen.

If you have had a version of Mnova installed previously, the installer will inform you that it is necessary to uninstall the previous version of Mnova. Make sure that this version is closed and click OK and then OK again to confirm. This will uninstall Mnova from your computer. You will get a message to inform you that uninstall was successful: click 'Continue'.

Once you have read and accepted the terms of the License Agreement, click on "**Next**" and select the destination folder where the program files will be placed in your computer. We suggest that you accept all the installation defaults. Once you have chosen the Start Menu Folder as prompted by the installer, click on "**Install**". This will install the application on your computer. On completing the installation, it will prompt you to select "**Finish**" to run the application.

3. Run the application on each host. The following dialog, notifying you that some licenses (for some plugins) were not found, will appear:

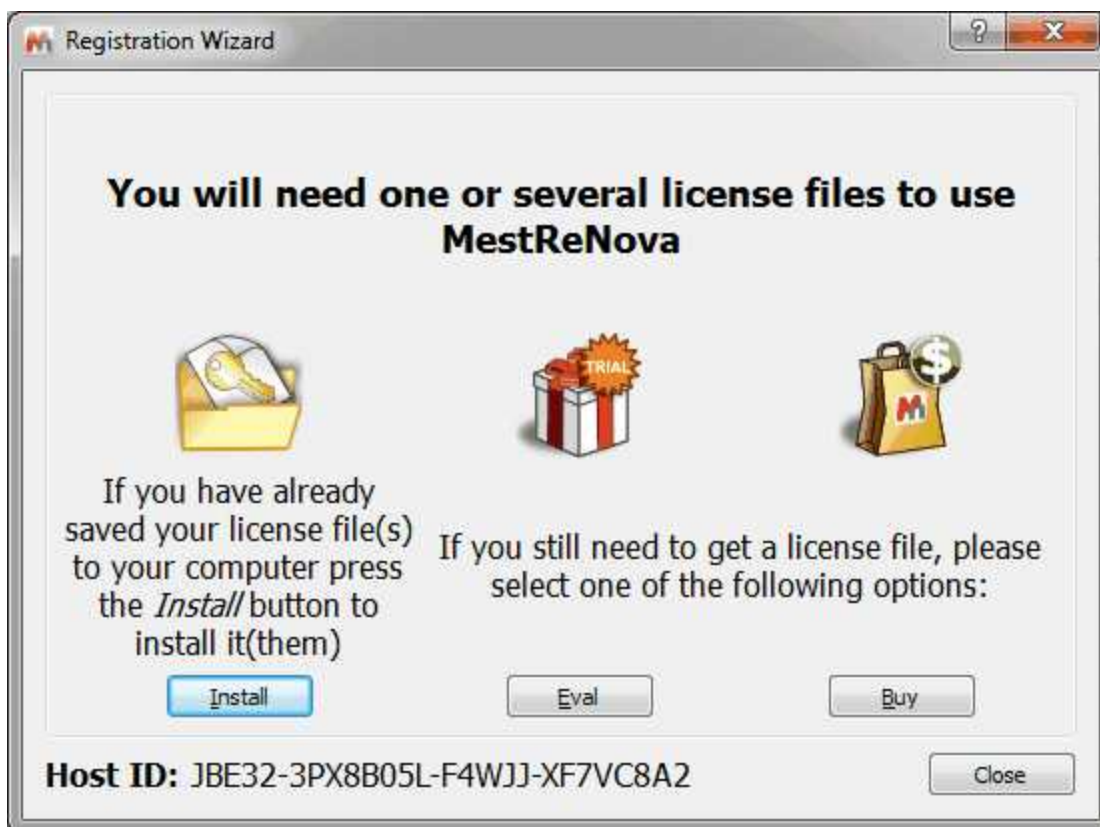

4a. If you want to make a trial, click on the 'Eval' button to be redirected to a website. Once there select if you want to do a 'Single Trial' or a Campus Trial':

Home // Free and fully-featured Mnova trial

Free and fully-featured Mnova trial

Anyone can try Mnova for free during 45 days by completing a very simple registration process. To start it just select the type of test you want to run.

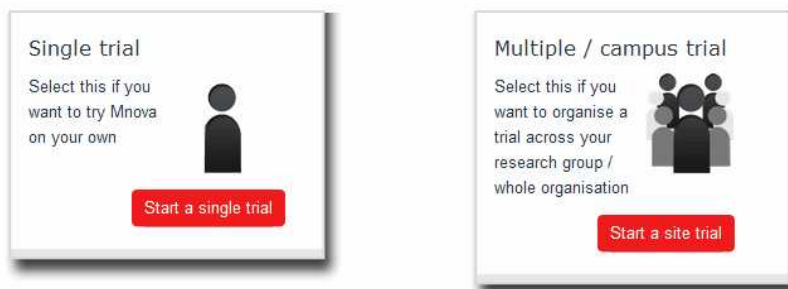

You will be redirected to a web page where you will be asked for a few registration details. An illustrative example appears below.

Products

Mnova Suite
 Mnova NMR Mnova NMRPredict Desktop Mnova MS Mnova Verify Mnova DB

Others
 Mnova NMR Lite Mspin

Host ID

Host ID * [How to get your Host ID \(this field will normally be prefilled\)](#)

Contact Details

Salutation * Name * Surname *
 Please select...

Email * Organization *

Country * Market * Role *
 Please select... Please select... Please select...

You will receive Mestrelab newsletters, updates and promos
 Tick this box if you do not want to be informed of interesting features and new Mnova versions and plugins

Your evaluation license will be generated after having clicked on 'Get a free evaluation license'.

4b. Alternately if you press the 'Buy' button you are again redirected to a web-page where a similar procedure occurs. However, instead of receiving a license right away your registration information and

your Host ID number are automatically sent to our Sales Department by e-mail. They will handle your purchase request and, once the financial formalities are complete, you will receive your licence file with installation and activation instructions by e-mail.

4c. If you have already a license file, click on the 'Install' button and go to the step 8.

5. It will display a window (Step 2/4) to inform you that you will receive an email to confirm your details

Home // evaluate // single // Single trial – Form received

Single trial – Form received

Thank you, we have properly received your form and sent you an auto-email so that you confirm your email address and details.

So please open the email we have sent to pablo@mestrec.com, click on the link included on the email and just confirm your data to download your license file.

Add us to your email address book

Make sure our emails end up in your inbox by adding the domains @mestrelab.com and @mestrec.com to your email address book or trusted-sender list



6. Once you have received the email, please click on the link to confirm that you are a human and **your email address and details are valid**. This will display a new window (Step 3/4) which will allow you to obtain your license file just by clicking on the 'Confirm email and download license files' button.

Single Trial – Download your license and get started

You are now at the step 2. You just need to confirm your email address and you will get your license(s) file(s)

1. Fill in the form with your trial details
2. Confirm your email and details
3. Start your individual trial



2- Confirm your email and details

Click on the button below to **confirm your email** (pablo@mestrec.com) and **download your license file for the Host ID: JBE32-3PX8B05L-F4WJJ-XF7VC8A2**

7. Save the 'Evaluation License' file on your disc.

Single Trial – Download your license and get started



Trial Resources

1- Trial licenses details

[2- Learning to use the software](#)

[3- Support](#)

[4- Purchase Mnova](#)

[5- Email and newsletter management](#)

1- Trial licenses and details.

[Click here to download all the license files you have requested.](#)

The activation is really simple but you can check [this training tip](#) in case you need help.



Trial licenses details for the Host ID:
JBE32-3PX8B05L-F4WJJ-XF7VC8A2

Name	Tested	Expiry date
Mnova NMR	Yes	2012-10-11
Mnova		

8. Drag&drop the license files to Mnova in order to activate it. You can also follow the menu ' Help/Get-Install Licenses' and click on 'Install' button.

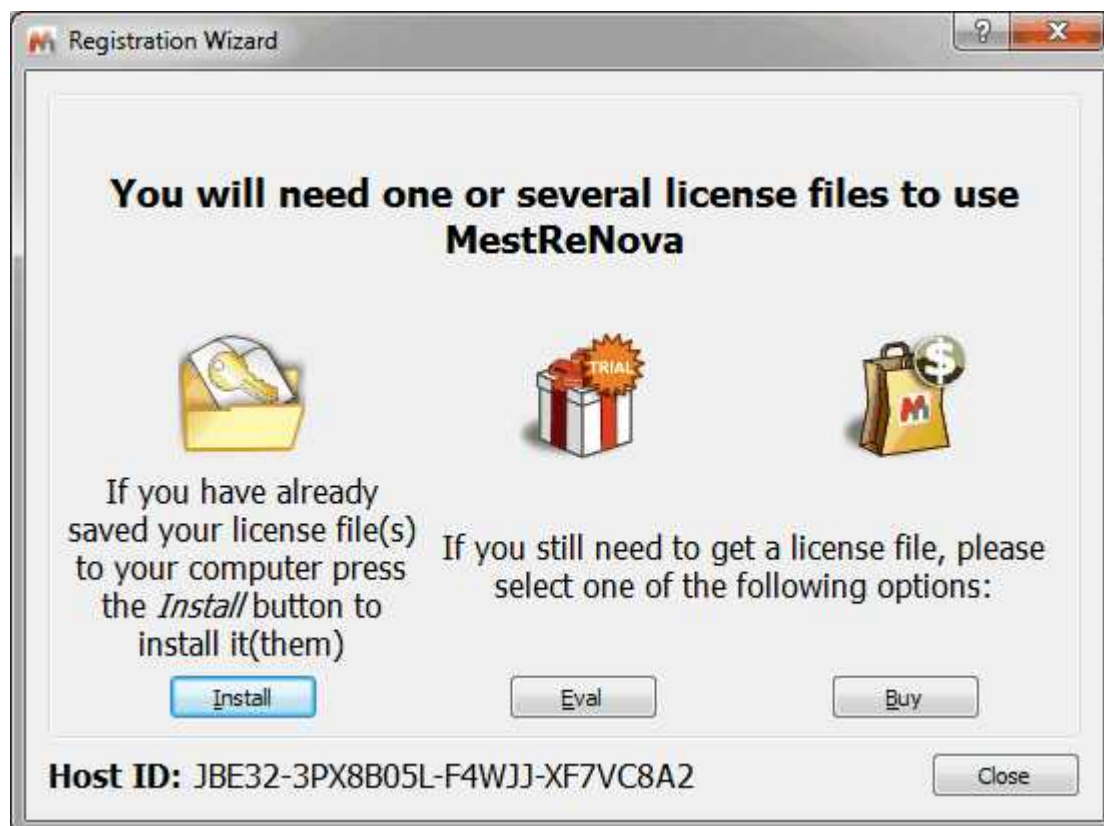

9. This will open the 'Select License File' dialog (see the picture below). Navigate on your Windows browser until you find the license file (or a .zip file containing several licenses), and double click on it and select it. Now you should be able to run the application without receiving an error message dialog.

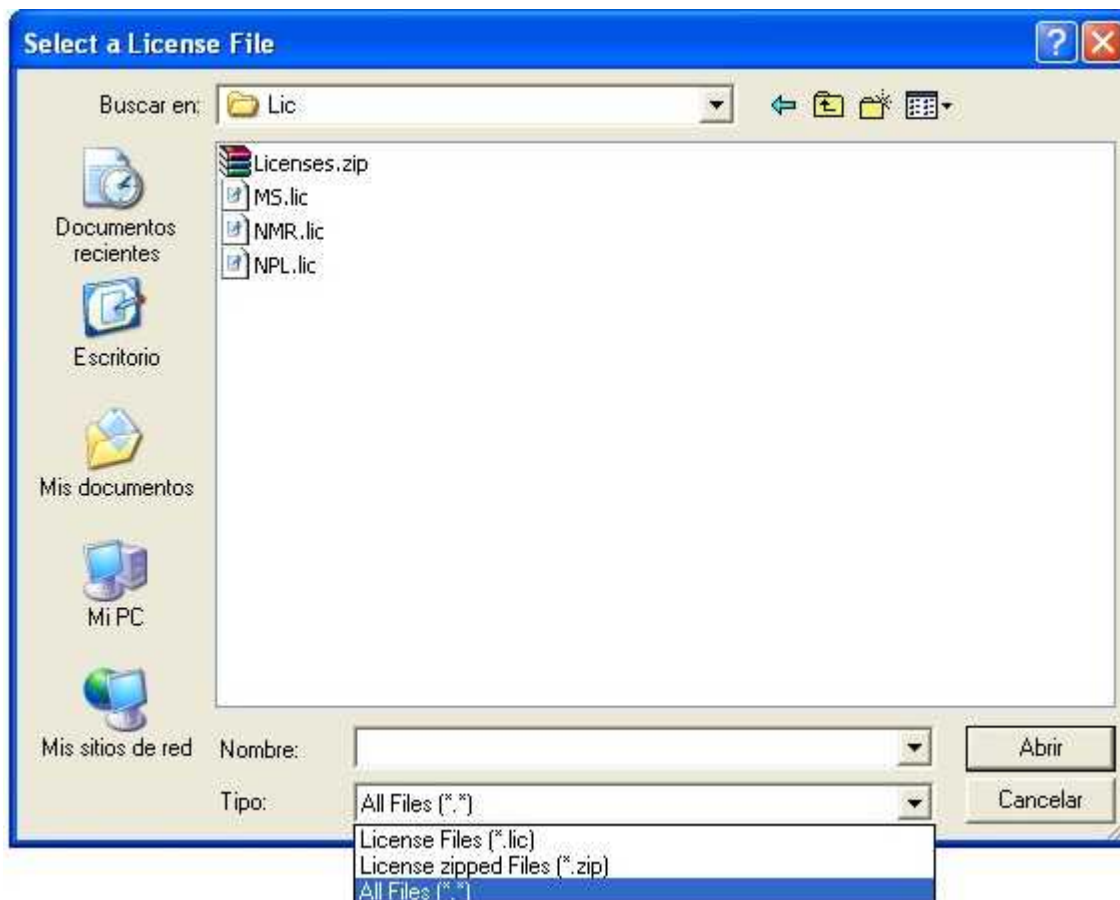

To install Mnova on **Linux**: download the Mnova SETUP file from a web address provided by us, and:

Debian, Ubuntu (*.deb): type from the command line interface: `dpkg -i namefile.deb`
 Other (*.rpm): type from the command line interface: `rpm -i namefile.rpm`

To update Mnova:

Debian, Ubuntu (*.deb): type from the command line interface: `dpkg -i namefile.deb`
 Other (*.rpm): type from the command line interface: `rpm -U namefile.rpm`

How to uninstall Mnova?

To **uninstall Mnova** on Windows; navigate to the Mestrelab Research S.L\MestReNova folder and double-click on '**Uninst**' . Finally confirm by clicking 'Yes'.

To uninstall Mnova on Mac, just move the application to the bin.

To uninstall Mnova in Linux:

Debian, Ubuntu (*.deb): type from the command line interface: `dpkg -r mestrenova`
 Other (*.rpm): type from the command line interface: `rpm -e MestReNova`

Part



3 Mnova 8.1

Welcome to **Mnova 8.1**

In our case, the fact that this is a *commercial release* means the following:

1. We have tested **Mnova** in-house as far as possible to make sure that we deliver to you a version which is robust, already of high quality, and which does not present any apparent bugs. However, you may find a small number of bugs which we have not yet identified. Please tell us about any you discover by e-mailing us at support@mestrelab.com
2. There are some advanced functionalities which will be included in the forthcoming commercial releases, but which are not yet in this version. The reason for this is that, in order to bring you the advantages of Mnova as soon as possible, we are bringing you the core functionality and more, while we complete some advanced and important but less-used functions. As a valued user of Mnova you will be notified the moment these additional functions become available as upgrades. As a result of this you may find some features which were present in the final release of **MestReC**, our current application, are not yet implemented into this commercial version of **Mnova**. A list of such features, together with their planned time of inclusion in the software, can be found below.
3. Although we have now released the product commercially, we are, as ever, very interested in your feedback, bug reports and implementation suggestions. Please keep this coming, as we plan for continuous and rapid improvement of the application, to make forthcoming releases even more in tune with our customer needs.

What's New? (click [here](#) to read the changelog)

New Features

Mnova NMR

- Spectrum parameters to show "Probe" by default
- New Purity Calculator script
- Capability to update gamma value of a DOSY spectrum depending on the detected nucleus
- Read D1 value from NUTS files to be used in Data Analysis
- Order the J-coupling constants in descending order in the multiplet label and J-list
- Automatically autophase DEPT spectra when importing
- New scripts have been implemented to autophase stacked spectra when importing:
 1. "NMR Tools/Auto-Phase Current, Same Phase Rest"
 2. "NMR Tools/Same Phase as Current"
- Auto-attach 1H and 13C traces to Anasazi's 2D experiments
- If you load 2D-Anasazi files in Mnova, you will get the corresponding 2D spectra with their 1H and 13C 1D spectra already attached in the horizontal and vertical traces.
- Ability to increase the linewidth to higher values than 10

Mnova MS

- Include MS Browser into MS Analysis Menu
- Zoom in both horizontal and vertical scale.
- In Preferences/Mass there is an option to fit to height after zoom (selected by default). When this option is checked, a fit to height is applied after making a horizontal zoom in a mass spectrum or a chromatogram. In case of the other zoom modes (vertical or in both dimensions), a fit to height is never applied.
- A better way to select an ion for Elemental Composition
- It is easier to select the highest peaks (which is now magnified) with the Elemental Composition tool.
- Different cursors for the different mass spectrum selection modes

Mnova Verify

- New scoring colors table

Mnova GUI

- Menu placement cleanup ("Blind regions" moved to the 'View menu', Verification moved to the 'Analysis', "Annotate" under the 'Edit' menu)
- The default layout of the toolbars was sorted out
- Warning message appears when Mnova finds duplicated script files

Mnova qNMR

- New module for compound quantification

Mnova RM

- Added RM Button to Data Analysis panel
- RM fitting reporting
- Improvements to "Directory spectra stack" script

Bugs Fixed

Mnova NMR

- Nucleus and Spectral Width in f1 incorrectly detected from a 1H31P HMBC from Varian
- Additional empty page obtained when exporting to pdf selected pages
- Stacked spectra exported as ASCII showed different results in 8.0 and 7.1.2 versions
- Problems reporting the whole Peaks table after making a report of selected rows
- Problems saving a spectrum (with horizontal units different with ppm) as Script: ASCII Matrix(*.txt)
- Withwashed view looked wrong in 2D spectra
- Peaks integrated using Peaks method did not get deleted
- Problem copy/pasting a spectrum from Mnova to MS Word as OLE
- Wrong order on assignments reported by Assignments script
- Wrong image pasted when copying and pasting a spectrum in Word
- New preference to handle how to draw text when exporting a metafile.
- Importing Apodization and LP gave a worse result in a COSY
- Active window title not updated when saving a file via script
- Problems when adding a second region in Data Analysis and clicking Undo
- Auto-phase correction algorithm for stacks didn't persist
- Experiment type not detected in a HSQC in JCAMP format
- Arrayed spectra from Tecmag could not be processed
- Problems loading a pseudo2D spectrum from Bruker
- Automatic phase correction options for 2D spectra did not persist
- Problems clicking on a X value after creating an empty graph
- Directory Spectra Stack script imported a spectrum although the nucleus was not the chosen
- Horizontal and vertical cutting were not possible in 2D spectra
- Problems referencing stacks made with the command "2D to 1D Stack"
- Problems saving a molfile without structure
- Incorrect number of protons in multiplets imported from a Jcamp file
- Problems trying to load a corrupted sdf file

Mnova NMRPredict Desktop

- Si prediction returns -10000 ppm chemical shift

Mnova RM

- Incorrect NN compensation in Concentration determination in RM wizard
- Cannot open Varian dataset array using RM/Import RM dataset
- Impossible to ignore Reaction Monitoring Plugin
- Wrong Response Factor dialog layout when no RM license

Mnova MS

- MS files not released after fetching full dataset and closing the document
- Bruker Compass not detected when installing Mnova
- Shimadzu software not detected when installing Mnova
- Mass Spectrum properties dialog too big when 5 or more plots are opened
- Problems opening Thermo LTQ data
- Wrong symbol and isotope when editing an isotope added in the Element Constraints

Mnova installer

- Drawing Tools not included when updating to Mnova-8.1.0 using msi installer
- Install advanced plugins option doesn't remember last directory

Mnova Database

- Problems running Mnova Database with floating licenses

- ... and more minor bugs fixed.

Our plan is to distribute a new release approximately every four months. The functionalities you can expect to see added to the software during the intervening period are:

- Derivative Processing of Spectra
- GEN-2D NMR, Processing to Improve Resolution in the Indirect Dimension.
- Spectral Editing
- Graphical User Interface Enhancements
- New Analysis tools

We hope that you will find this version of Mnova to be one of the most complete NMR processing and analysis tools available in the market, combined with a revolutionary interface and many new, original and innovative features.

During the commercial release periods, we will welcome your **feedback**, both in the form of bug reports and also of implementation suggestions and feedback on current development. Please write with any of these to support@mestrelab.com



























Thank you once again for your support of our development effort!

Part



4 Shortcuts

Mnova provides shortcuts for finding commonly sought tools. You can see a list of these commands by following the menu 'Help/Shortcuts':

	Command	Shortcut
1	 Analysis > Assignments > Manual Assignment	A
2	Analysis > Assignments > Swap Assignments	S
3	 Analysis > Integration > Manual	I
4	 Analysis > Multiplets Analysis > Manual	J
5	 Analysis > Peak Picking > Manual Threshold	K
6	 Analysis > Peak Picking > Peak by Peak	Ctrl+K
7	 Analysis > Reference > Graphic Reference	R
8	 Analysis > Reference > Reference	L
9	 Documents > Close	Ctrl+F4
10	 Edit > Annotate > Text	T
11	 Edit > Copy	Ctrl+C
12	 Edit > Create New Page	Ctrl+M
13	 Edit > Cut	Ctrl+X
14	 Edit > Delete	Del
15	 Edit > Paste	Ctrl+V
16	 Edit > Redo	Ctrl+Y
17	 Edit > Select All	Ctrl+A
18	 Edit > Undo	Ctrl+Z
19	 File > Export to PDF...	Ctrl+D
20	 File > New Document	Ctrl+N
21	 File > Open Directory...	Ctrl+I
22	 File > Open...	Ctrl+O
23	 File > Print...	Ctrl+P
24	 File > Save	Ctrl+S
25	 Help > Contents	Ctrl+F1
26	Integral Manager	Shift+I
27	Multiplet Manager	Shift+J
28	 Processing > Apodization...	W
29	 Processing > Baseline > Baseline Correction...	B

Part



5 Fast Visual Guide to process routine 1D-NMR datasets

You will find the quinine datasets in the installation folder of Mnova (under the examples/datasets folder)

Go through the following procedure to process a routine 1D-NMR spectrum:

1. Drag and drop the folder containing the FID file (in the first level of folders) into Mnova to get your spectrum fully processed. If the folder contains a .mol file, the molecular structure will be also displayed. (You can also follow the menu 'File/Open')

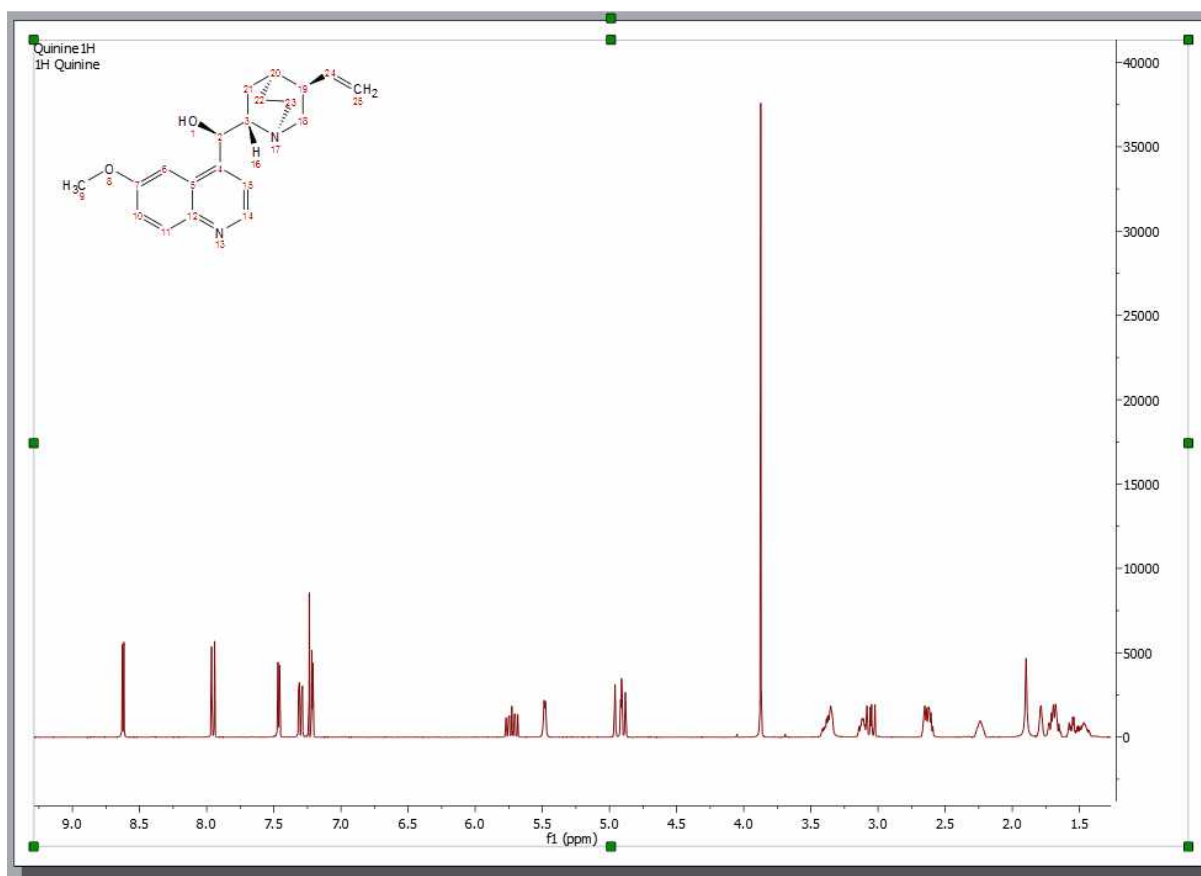

2. If your spectrum is not referenced, you can calibrate it by clicking on the 'Reference' button and then selecting the peak you want to be a reference point.



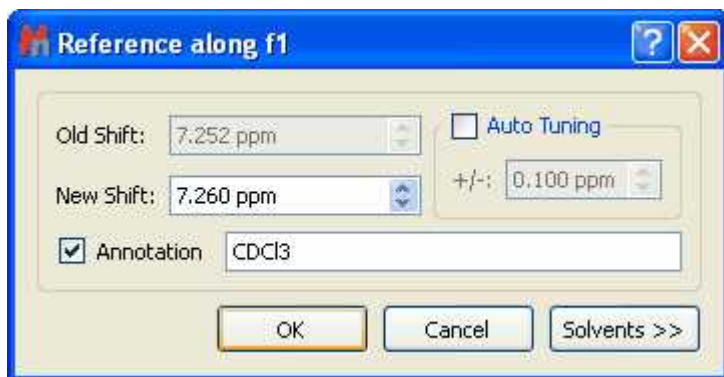

3. Click on the '**Baseline Correction**' icon  to correct the Baseline of your spectrum.

4. To paste the Parameters Table on the spectral window, just follow the menu: 'View/Table/Parameters' and click on the '**Report**' icon. Please bear in mind that you can resize any object by just clicking and dragging on any border. In this case the spectrum has been resized in order to put the table at the right side of the page.

1. View/Tables/Parameters

2. Click on the 'Report' button

Parameter	Value
1 Title	1H Quinine
2 Origin	inova
3 Solvent	CDCl3
4 Pulse Sequence	s2pul
5 Acquisition Date	2007-10-22T11:21:46
6 Temperature	25.0
7 Number of Scans	200
8 Spectrometer Frequency	399.97
9 Spectral Width	6399.5
10 Lowest Frequency	-799.9
11 Nucleus	1H
12 Acquired Size	8959
13 Spectral Size	32768

5. Apply an automatic multiplet analysis by clicking on the '**Multiplet Analysis**' icon . It will apply an automatic Peak Picking analysis with solvent and impurities recognition. As you can see in the

example below the CDCl₃ signal has been detected and its peak label appears in red.

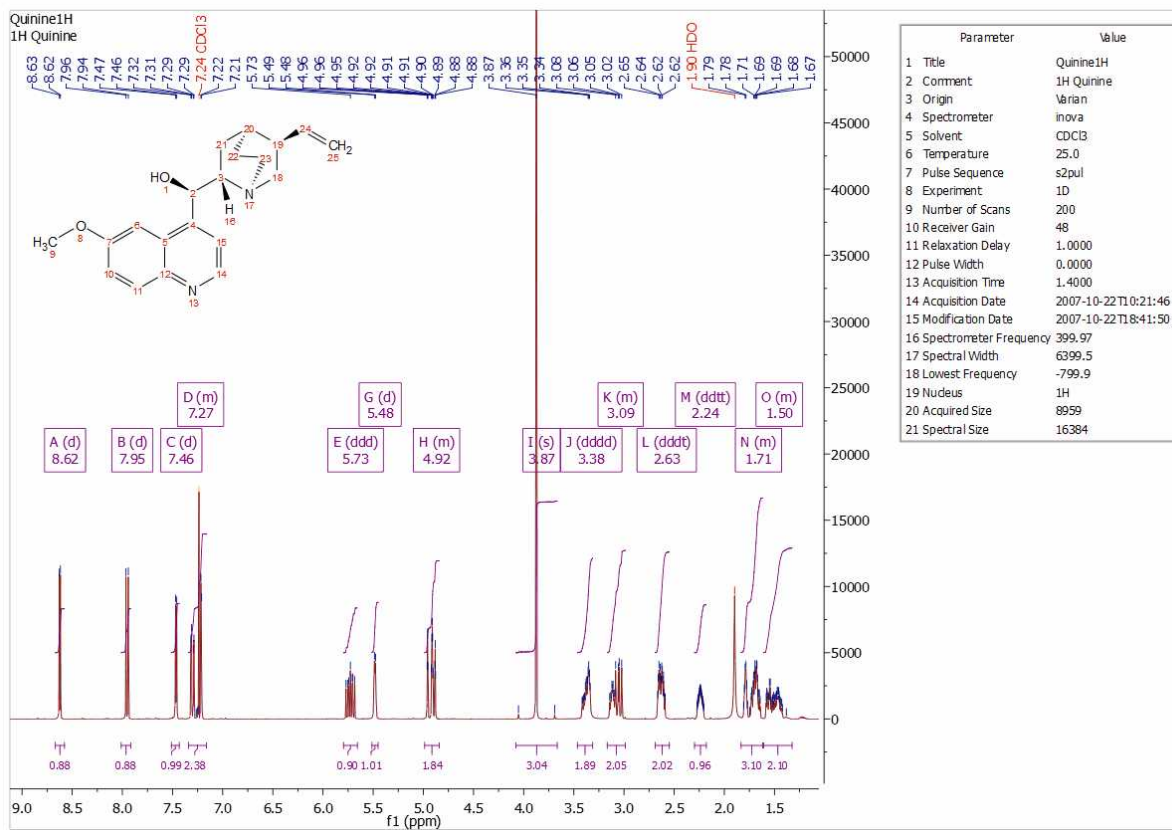

6. Double click on the multiplet box to normalize the 'multiplet integral' values:

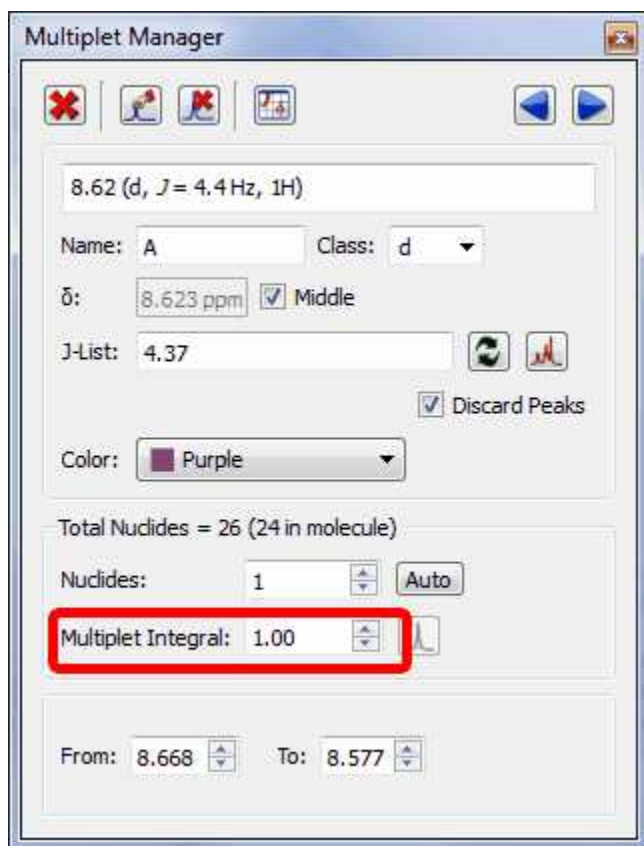



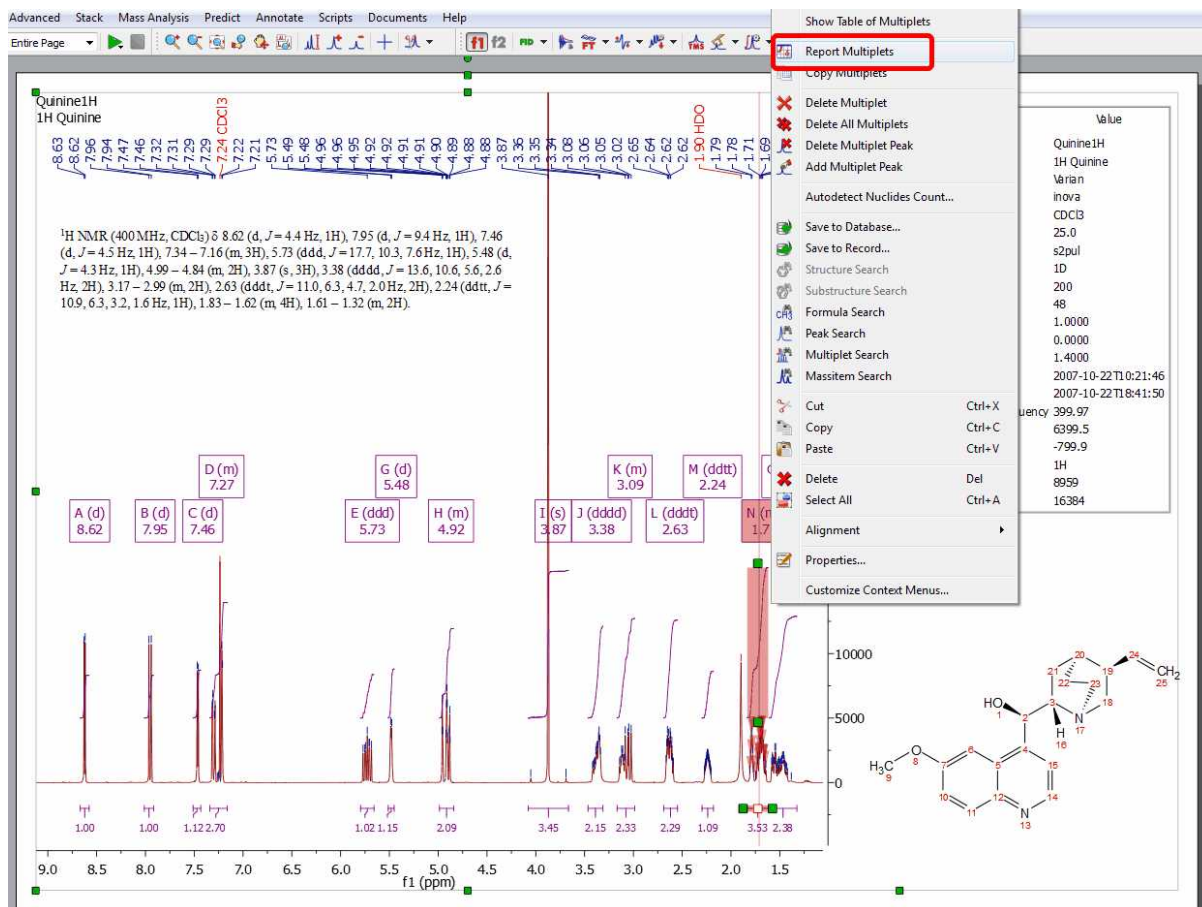

7. To obtain the multiplet report list just right click on the multiplet box and select 'Report Multiplets':

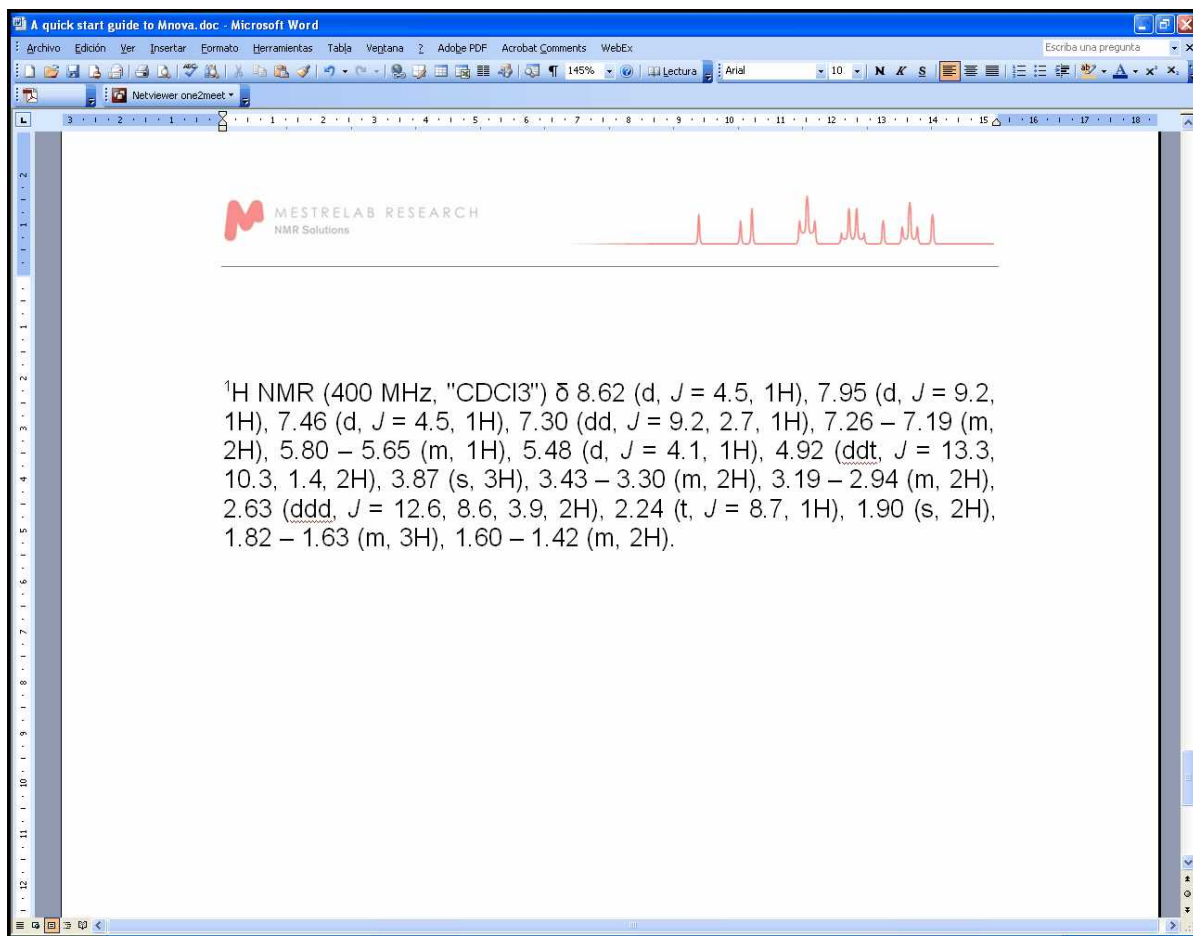

Please bear in mind that you can freely move any Mnova object just by clicking&dragging. In the example above we have moved the molecular structure and the multiplet report

8. It is possible to copy the multiplet report to the clipboard just by right clicking on the multiplet box and selecting 'Copy Multiplets' (or by selecting 'Copy Text' on the Multiplet Table) and then paste the report in another document just by using Ctrl+V (or Cmd+V in Mac).



9. Finally, you will be able to save , print  or export to PDF , the document by clicking on the applicable icon in the toolbar.

See also:

[1D Processing Tour](#)

[Fast Visual Guide to process routine 2D-NMR experimental data](#)

Watch a miniclip on this functionality at this [link](#)

Part



6 Fast Visual Guide to process routine 2D-NMR datasets

(Not available in Mnova Lite)

You will find the quinine datasets in the installation folder of Mnova (under the examples/datasets folder)

The procedure to process a **2D-NMR** spectrum is very similar with the monodimensional one:

1. Drag&drop the folder containing the spectral files or click on the 'Open File' icon  and select the FID file (or SER file in Bruker) to obtain the processed 2D-NMR spectrum. **Mnova** will select the processing functions for you (FT, Phase Correction, etc) but, of course, you may change and optimize any of them and then re-process the data if you wish.

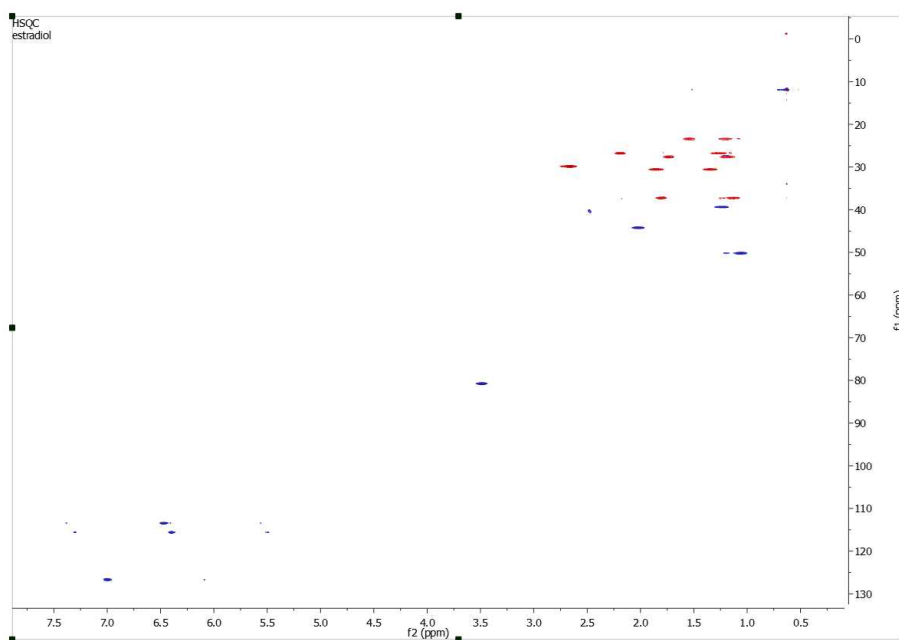

2. It will be possible to drag and drop any currently opened 1D-NMR spectrum to a 2D NMR dataset in order to get them as traces. Here you can see how the page number 1, containing a 1H dataset is dropped to the HSQC to get the horizontal trace:

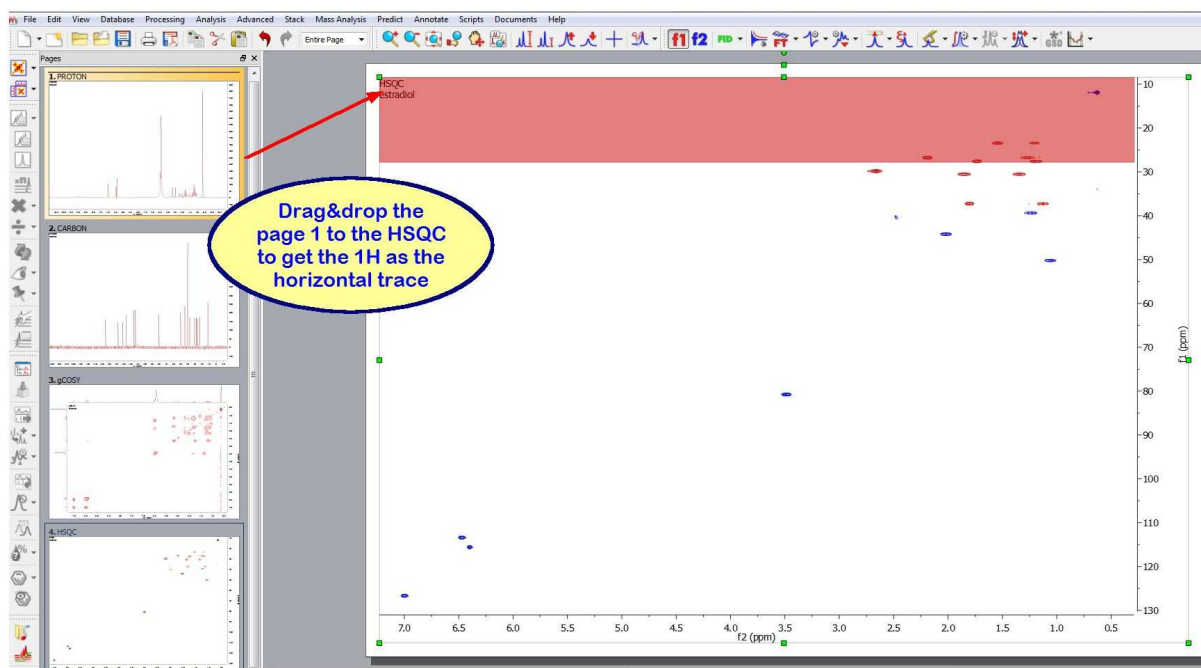

The same can be done with the page 2 (containing a 13C spectrum) to get the vertical trace:

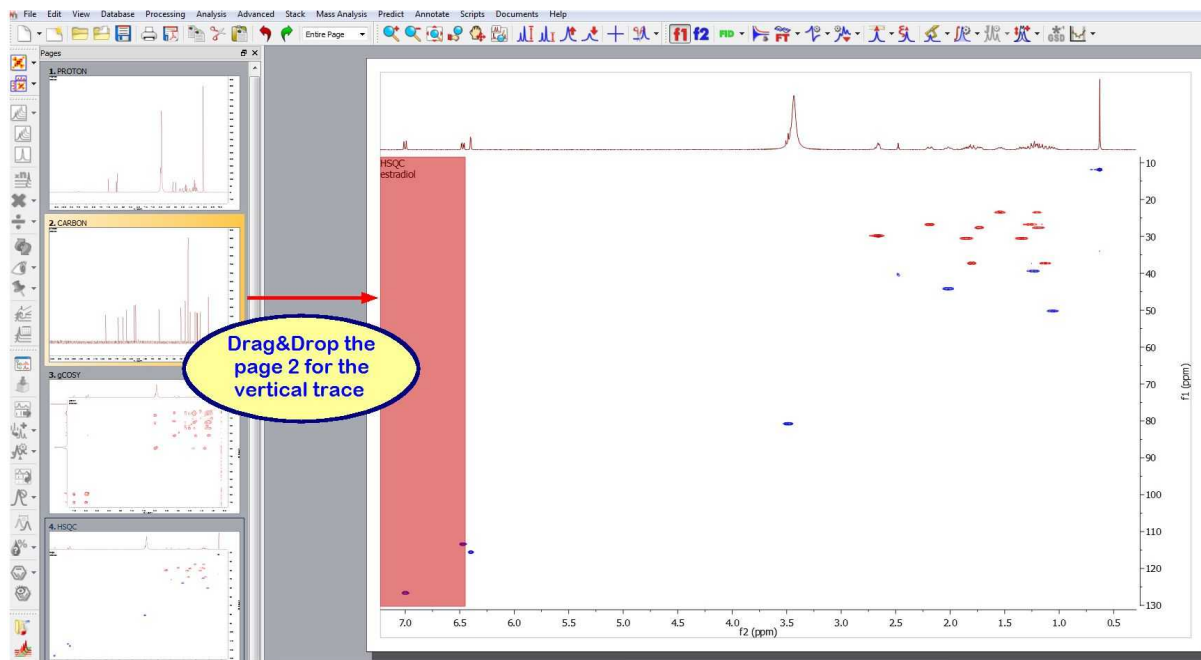

Here you can see the result:

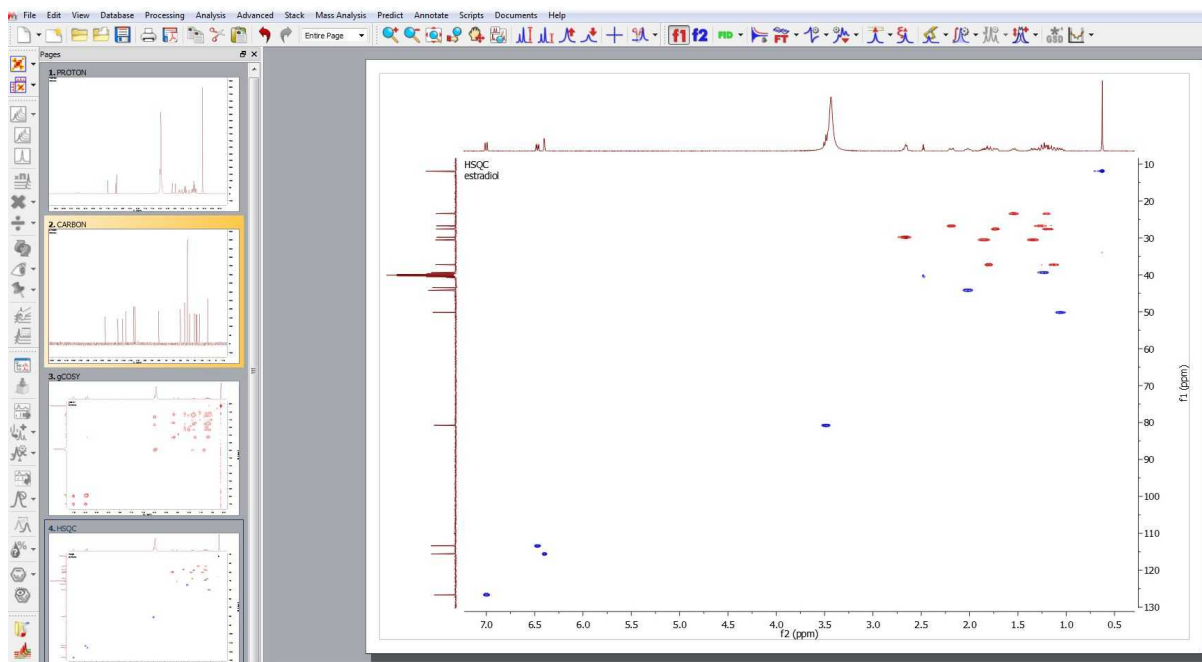

3. To calibrate your spectrum, just click on the **Reference** toolbar button  and then select the peak you want to be a reference point. Finally, select the desired reference along f2 and then along f1:

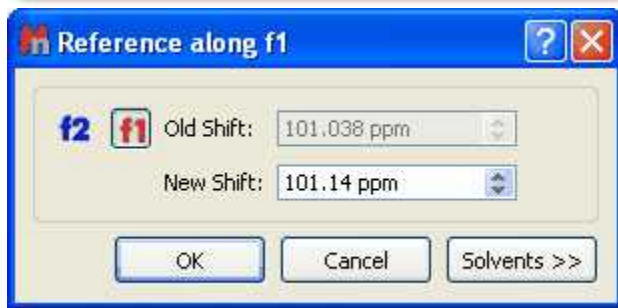
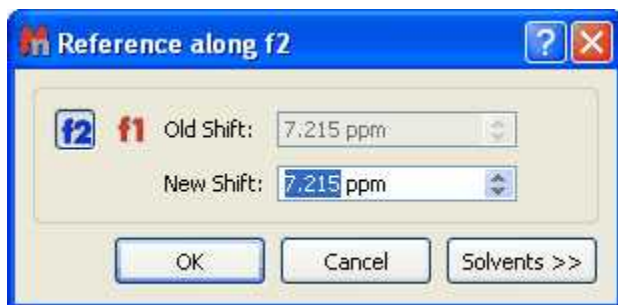

If you have your ^1H and ^{13}C NMR spectrum loaded, you can use the 'Absolute Reference' feature to reference 2D & C-13, by clicking on the 'Absolute Reference' button of the toolbar (or by following the menu 'Analysis/Absolute Reference'):

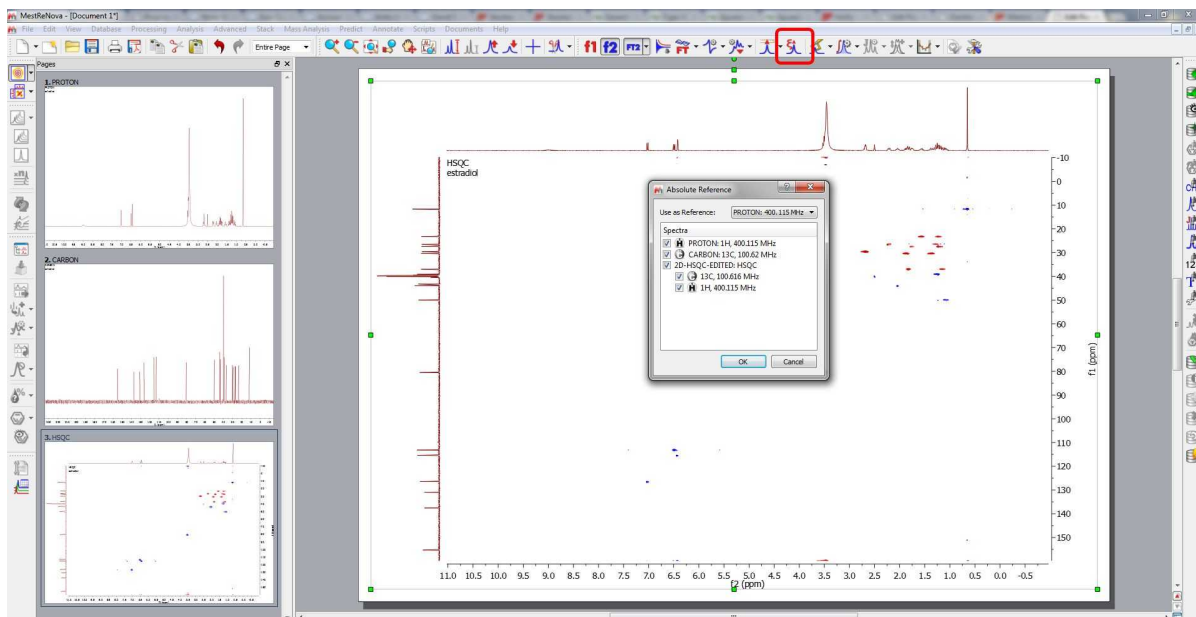

4. Click on the **'Peak Picking'** icon  to run a Peak Picking analysis and follow the menu 'View/Tables/Parameters' to display the 'Parameters Table'.

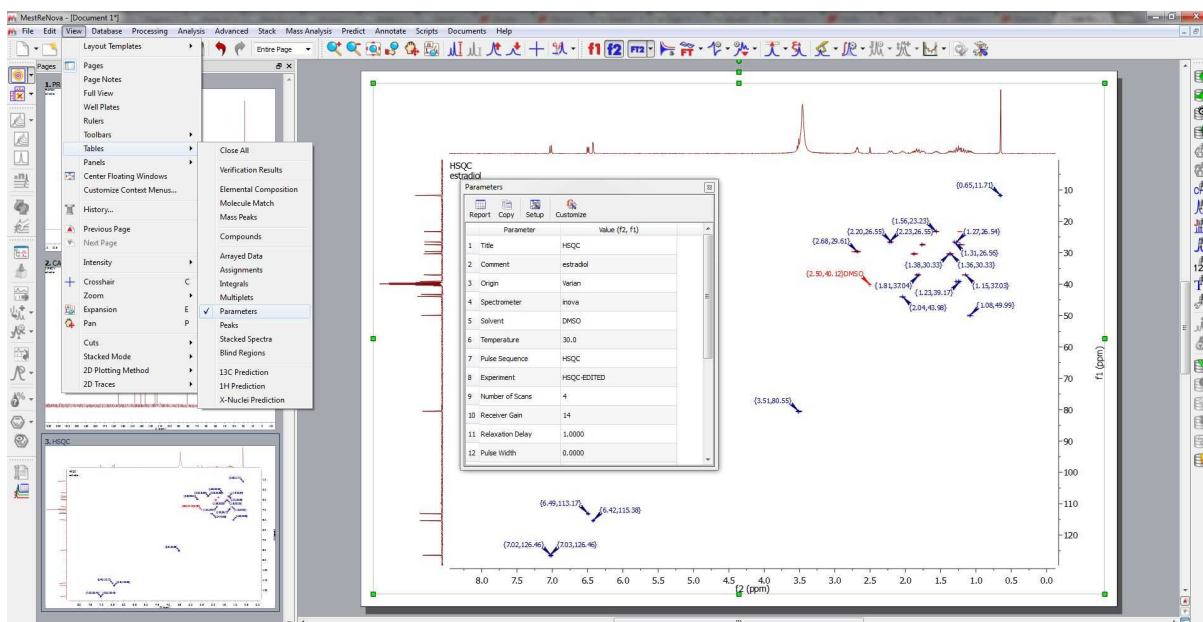

5. Then, click on the 'Report' button to paste the table on your page and move it to the right (by clicking&dragging). Finally resize the 2D spectrum to get the report below:

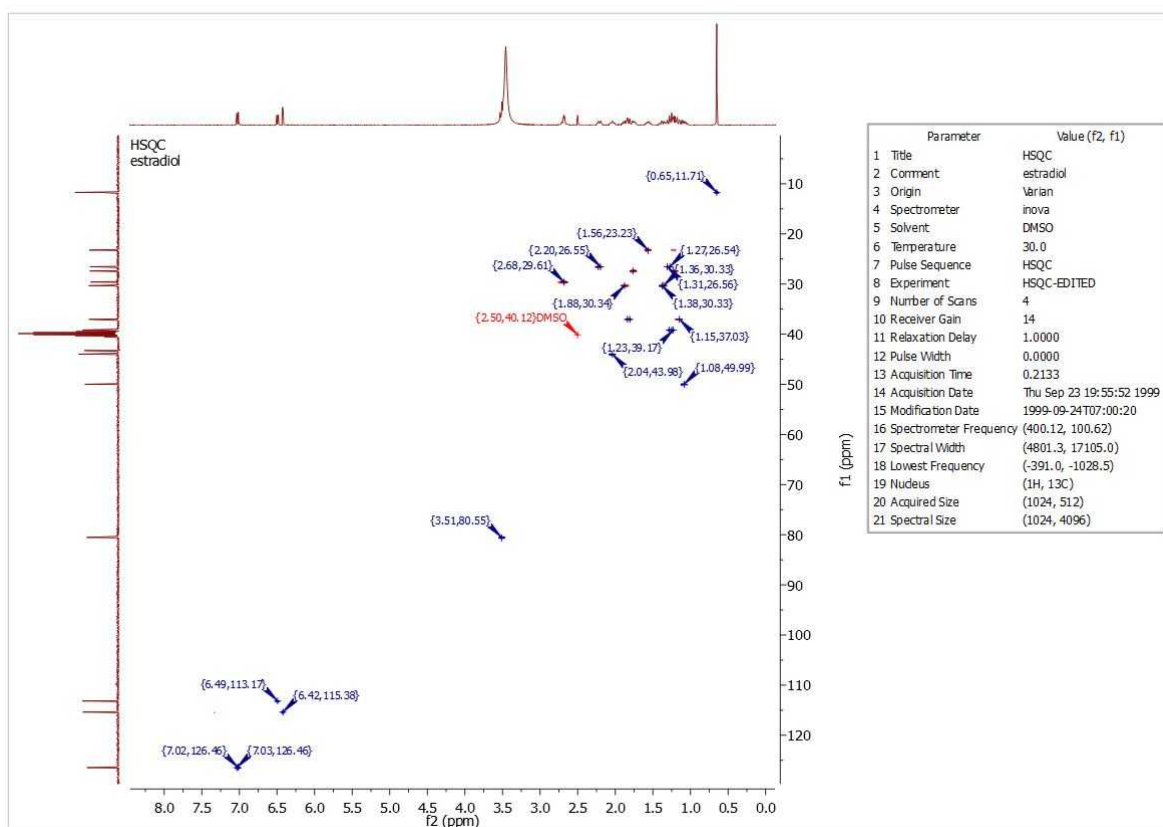
**See also:**

[Fast Visual Guide to process routine 1D-NMR experimental data](#)

[1D Processing Tour](#)

[2D Processing Tour](#)

[Manual Phase Correction in 2D-NMR](#)

Watch a miniclip on this functionality at this [link](#)

Part



VII

7 The Mnova interface

The **Mnova** interface has been designed to minimize the learning curve for the new user, by capitalizing on familiarity and commonality with some of the most commonly used general software packages on the market. The interface consists of a main page window with a menu bar, toolbars, dialog boxes, rulers, active window tabs, etc. giving users total flexibility in the organization of their data. With **Mnova** you will only need a couple of mouse clicks to open and process your NMR data automatically. When you first open **Mnova**, you will immediately notice a few things which represent the fundamental graphical principles of the program:

- First of all, the software is **multipage**, à la **Powerpoint**.
- The **Mnova** Graphical User Interface is based on the 'What You See Is What You Get' principle (**WYSIWYG**).
- The **Mnova** graphical engine makes extensive use of the anti-aliasing technique to produce very high quality spectral plotting.
- The program includes a powerful **Undo/Redo** mechanism within a standard toolbar.

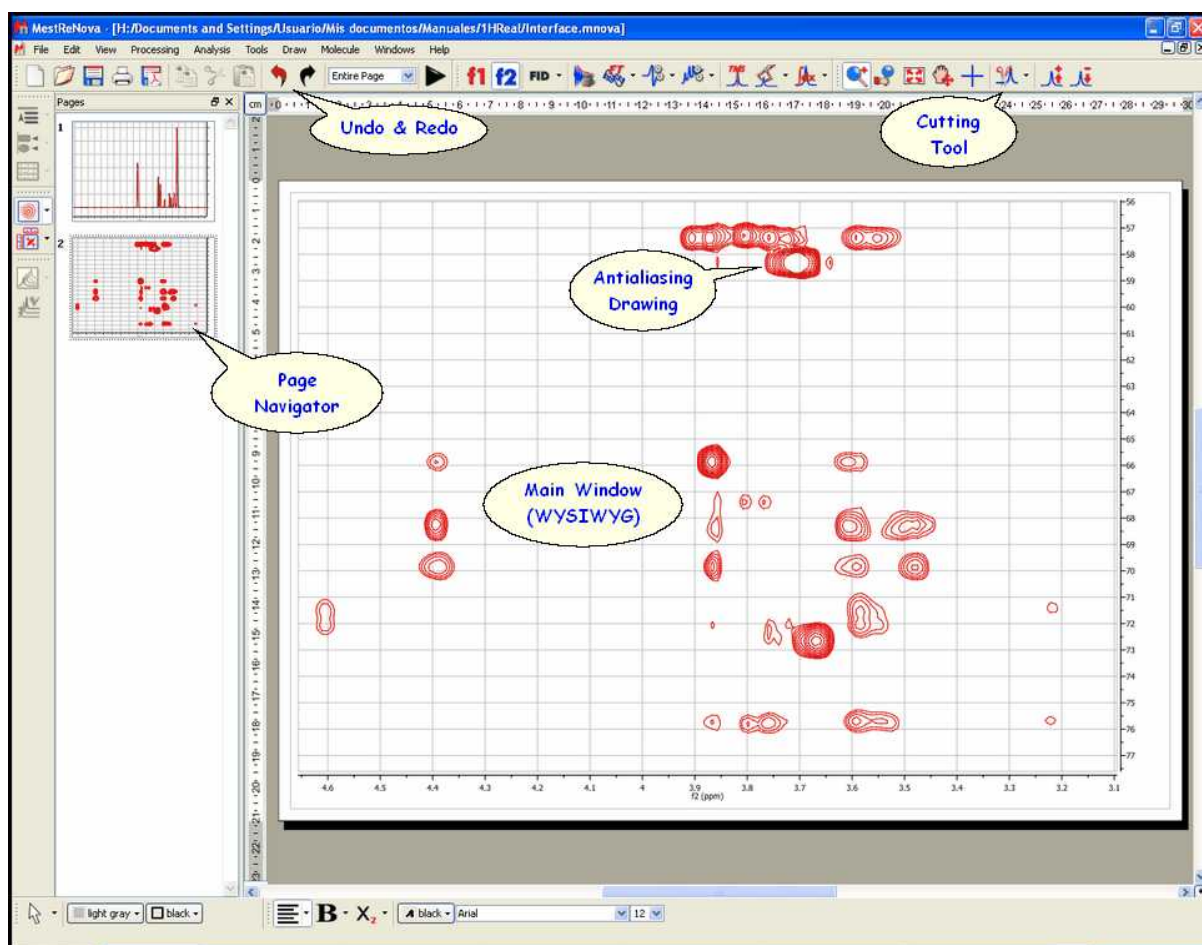

In a few minutes and thanks to the intuitive interface you will gain a good command of the most powerful and modern tools provided by Mnova, such as:

- One single command to open and process FIDs in any file format
- Powerful drawing tools with advanced text editing capabilities.
- Cutting tool to exclude uninteresting regions from the spectrum.
- Powerful scripting engine.
- Molecular viewer with assignment capabilities.
- Prediction of ^1H and ^{13}C NMR from chemical structures.
- And much more...

See also:

[Multipage Software](#)

[Working on a single page](#)

[Zooming](#)

[Cutting](#)

[Undo & Redo](#)

[Graphics & Annotations](#)

7.1 Multipage Software

The **Mnova interface** is designed to look and feel like **MS PowerPoint**. We think that the great majority of people in science are familiar with this presentation and reporting software, and that making our program behave in a very similar way to Powerpoint will ensure that even new users find it very easy to work with from the very start.

The first thing you will notice is that the software is **Multipage**, and incorporates a **page navigator**, which is placed, by default, as a column on the left hand side of the screen.

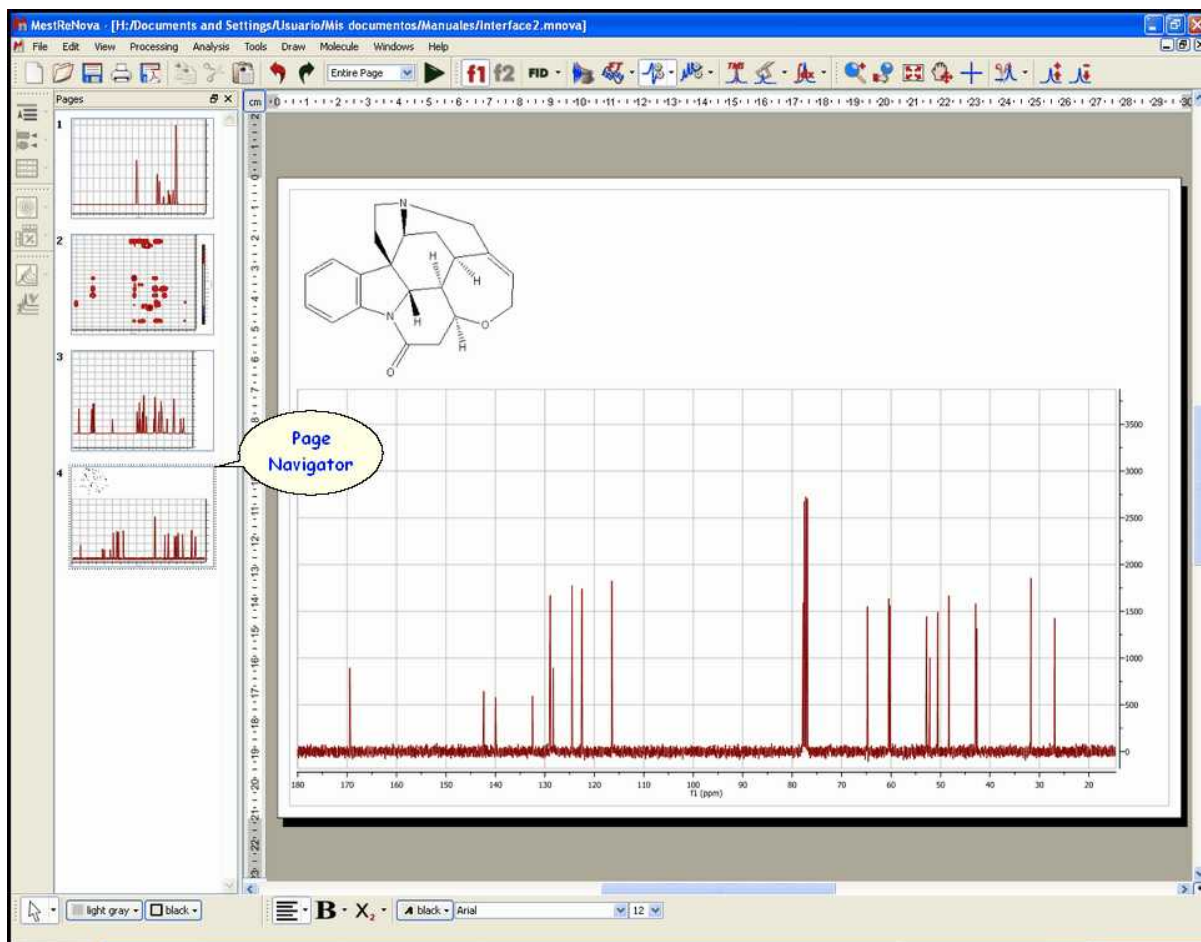

The **Mnova document** is a **Multipage Document**. This means that *all pages within a single document will be saved as a single document*. This will allow you to keep, for example, different experiments for a certain sample (^1H , ^{13}C , homonuclear and heteronuclear 2D correlations) as a single, unified document.

The active slide is highlighted in blue, and will appear in the main paper area of the document. This is the page to which all selected operations will be applied. You can choose the desired spectrum just by clicking on it on the page navigator or by following the menu 'View/Previous or Next Page'. In the same way, if you have highlighted any spectrum in the page navigator, you can move to the previous or the next spectrum by using the up or down arrow keys.

There are a number of things you can achieve by working on the page navigator:

- ✓ It is possible to alter the **order of the pages** by simply left clicking on a page, dragging it and releasing the mouse to drop it at the desired position.
- ✓ It is also possible to **Create a New Page** by selecting 'Edit/Create New Page', by right clicking on the page navigator window and selecting 'Create New Page' or by holding <Ctrl>+M (or Cmd + M in Mac).
- ✓ You can easily **Delete** an undesired spectrum by 'Edit/Delete' or by right clicking on the spectrum or on the page navigator and selecting 'Delete'. A selected spectrum can also be deleted using the 'Del' key.
- ✓ It is possible to **select more than one page** by holding the <Ctrl> key (or Cmd in Mac) whilst clicking on the desired pages. When more than one page is selected, all operations (zooming, cutting, processing, etc.) will be applied to all selected pages.

- ✓ It is possible to **copy** a page to the clipboard by simply pressing the <Ctrl> key (or Cmd in Mac) and then left clicking on the desired page, then dragging and releasing it whilst still holding <Ctrl> (or Cmd in Mac). Of course, a page can also be copied by selecting it and then choosing 'Edit/Copy', or <Right Click> and then Copy or by using the keyboard shortcut <Ctrl+C> (or Cmd+C for Mac). Any of these methods can be followed to copy one or several pages at a time, depending on what is selected when applying these operations.
- ✓ Conversely, a page or several pages can be pasted by using 'Edit/Paste', or <Right Click> and then Paste or by using the keyboard shortcut <Ctrl+V> (or Cmd+V for Mac).
- ✓ Finally, you can hide or move the page navigator, by clicking on the boxes highlighted on the picture below (or by following the menu 'View/Pages').

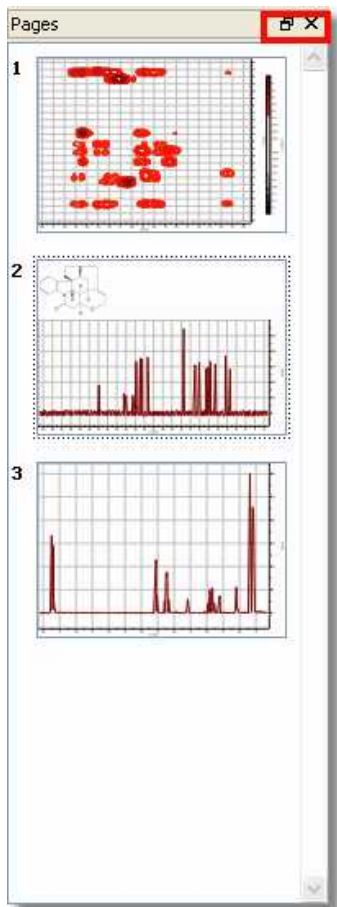

In order to navigate from one page to the other, you can use the page navigator or the arrows controls shown in the picture below (at the right down corner of the spectral window) . You will be able to show the page navigator by clicking on the last button of the picture below:



Please bear in mind that it is possible to edit the title of the spectrum shown in the page navigator just

by right clicking on it and selecting 'Edit Page Title' or by following the 'Edit menu':

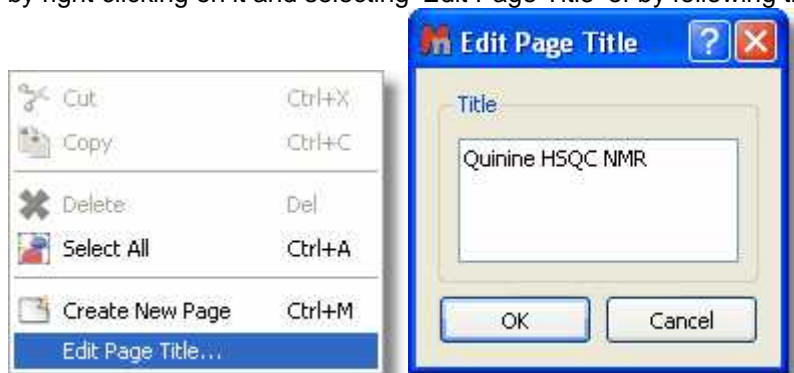

7.2 Working on a Single Page

Whilst **Mnova** is a multipage document, it also allows you to have several objects (e.g. spectra) within a single page. The easiest way of placing two spectra on the same page is to simply select one of them, copy it ('**Edit/Copy**', <Right Click> and **Copy** or <Ctrl+C> (or Cmd+C for Mac)) and then paste it directly on the desired page (Select the desired page and press 'Edit/Paste', <Right Click> and **Paste** or <Ctrl+V> (or Cmd+V in Mac)).

Note that the **active object** is highlighted with **green squares** (in the green circle in the figure below). Any **Mnova** object can be **resized** and **moved** by just clicking and dragging on the corner boxes or on the object respectively. Note also that any other objects selected but not active will be highlighted with white squares (in a blue circle in the figure below) (To select more than one object, hold the <Ctrl> (or Cmd in Mac) key while clicking on the desired objects. To select all objects on a page, just choose 'Edit/Select All' or the keyboard shortcut <Ctrl+A> (or Cmd+A in Mac)).

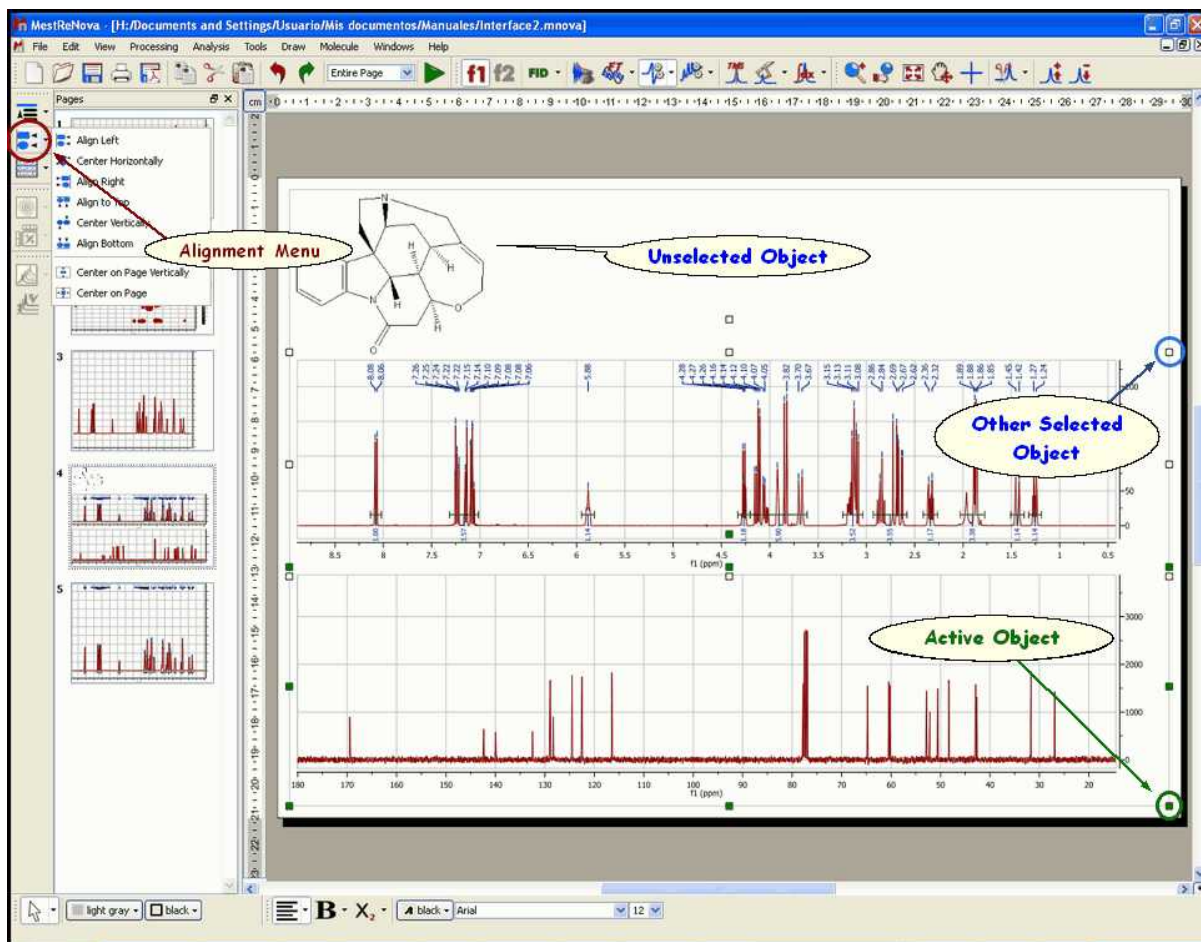

Once more than one object (spectrum or otherwise) has been placed on the same page, it can be manipulated and placed on the page by using the scroll menu shown in the figure below, accessible via the 'Alignment' icon .

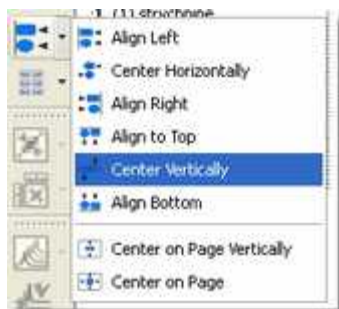

This scroll menu will allow you to **Align Left, Right, Top and Bottom**, to **Center Horizontally or Vertically** (applying this last operation with multiple objects selected will Superimpose them). Of course, you can move the spectrum selected in a given direction using the arrow keys of your keyboard. Remember that multiple objects must have been selected for these commands to work effectively. You can also superimpose several spectra by using the ['Superimpose'](#) feature.



Utilities

The superimpose option is very useful when attempting to identify a known compound present in a complex mixture or when comparing similar compounds.

Any operations applied to the active object will also be applied to the other selected objects (zooming, panning, cutting, processing operations, etc) as was the case with multiple pages selected.

7.3 Mnova Menus & Toolbars

The graphical user interface is the part of Mnova that you interact with to perform tasks; it consists of a main page window, page navigator, menus, toolbars, dialog boxes... giving users total flexibility in the organization of their data.

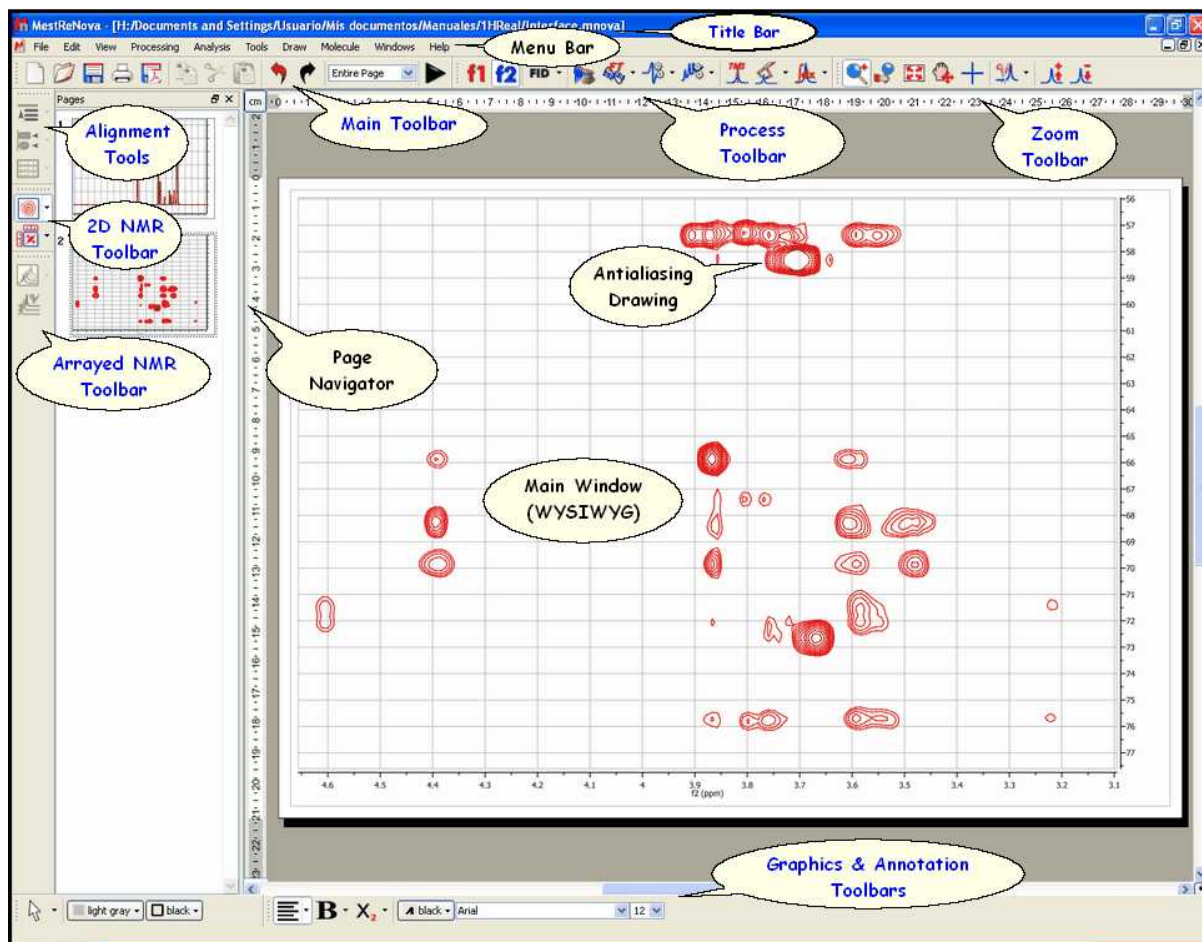

Title Bar: This blue bar shows the name of the active document

Menu and Toolbars: All Mnova commands and functions can be accessed from the menus and toolbars. The toolbars contain icons which offer shortcuts to many commonly used functions (you can select which ever toolbars you would like to display from the View menu). The user will be able to change the location of the toolbars to anywhere in the screen just by clicking on the border and dragging.

File Menu: In addition to the usual File commands (such as: 'New', 'Open', 'Open Directory', 'Close', 'Save', 'Save as', 'Page setup', 'Print' or 'Exit') you will find:

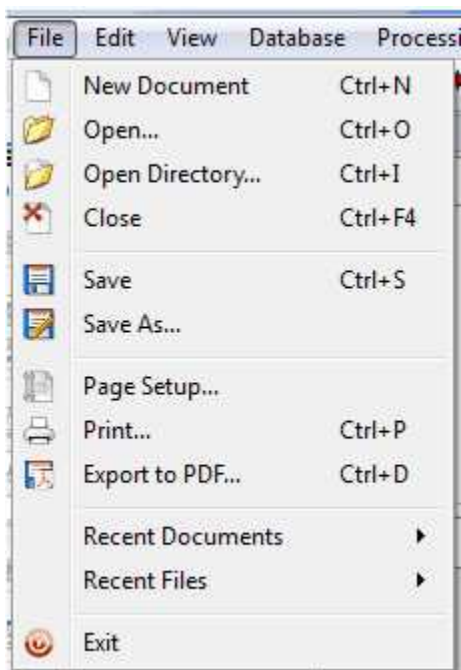

Mnova is able to import several spectral formats, image files and molecular structures (.mol) as you can see in the picture below:



Please bear in mind that the user will also be able to load any spectrum from the command line, just by typing the path where the Mnova exe file is located, followed by the path where the FID (or ser) file is stored. For example:

```
"C:\Programs Files\Mestrelab Research S.L\MestReNova\MestReNova.exe" "C:\Documents and
```

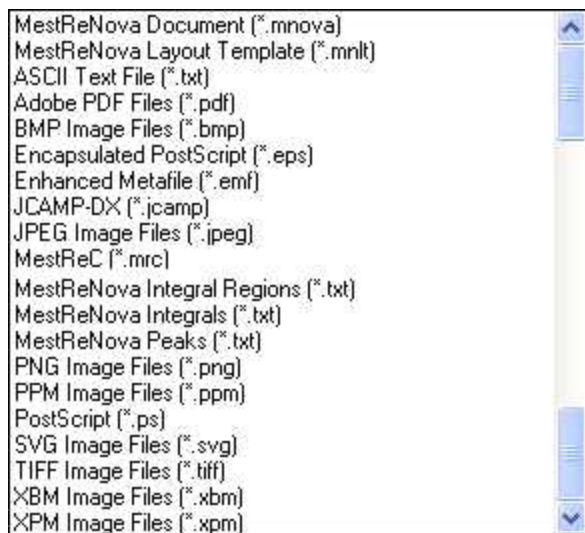

Settings\User\My documents\1HRealfid"

The user will be able to save the spectra in different formats by following the menu 'File/Save as', as you can see in the picture below:

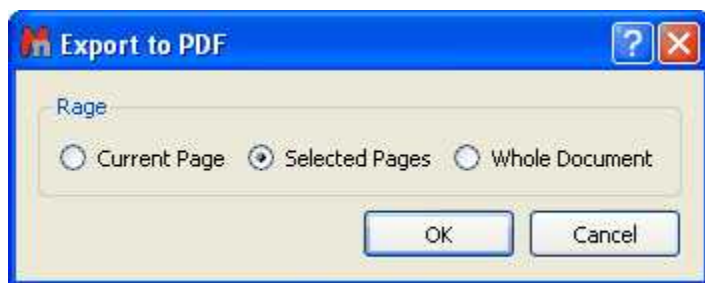

Please bear in mind that you can also save the integral regions, the peaks and the template used in your document by using this command.

'Export to PDF': This is a useful option to convert your Mnova document to PDF. You will be able to export the 'Current Page', the 'Selected Pages' or the 'Whole Document':



It is possible to select the PDF export resolution from the 'Edit/Preferences' menu.

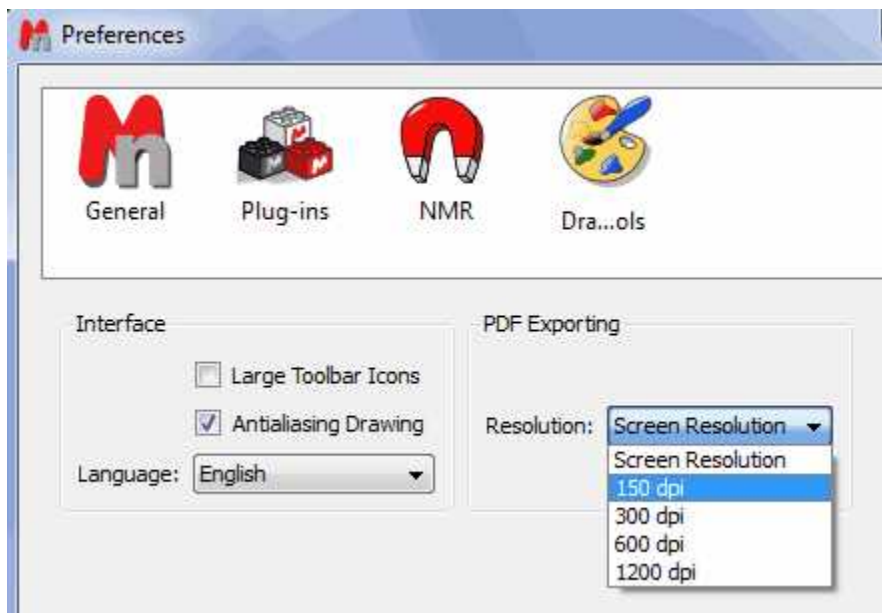

'Recent Documents' & 'Recent Files': Dragging the mouse to these options you will be able to select the most recent documents or files.

Edit Menu: In addition to the usual Edit Functions (such as **Cut**, **Copy**, **Paste**, **Paste Special**, **Insert Object**,...) you will find:

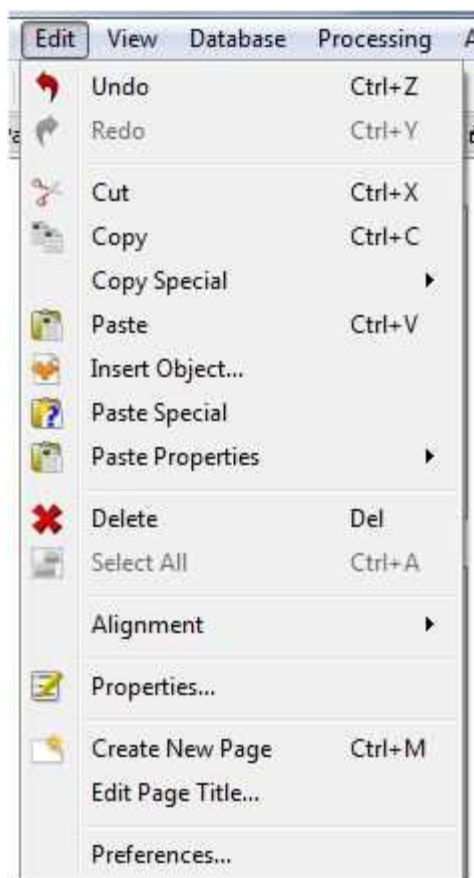

'Undo & Redo': Mnova implements very powerful Undo and Redo capabilities. If you select 'Undo', Mnova will reverse the last change done to the document, restoring it to its previous state. The Redo command reverses the undo. These tools are incorporated in the Standard Toolbar, so they will be fully described further on.

Copy Special: to copy the dataset just as an image (very useful for large datasets), without OLE properties but reducing the file size of the document.

Insert Object: to insert any other object from a third application.

Paste Special: to paste from the clipboard any object copied in a third application.

It is also possible to copy&paste the spectral properties or the regions from one spectrum to another, just by pressing 'Ctrl+C' in the original spectrum and then following the menu 'Edit/Paste Properties' in the other spectrum (or spectra, if you have previously selected them in the page navigator):

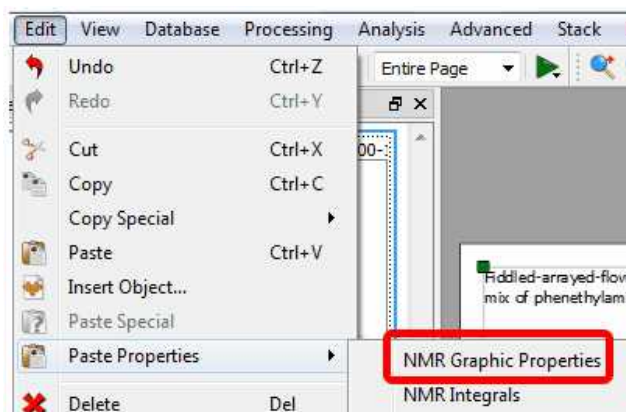

'Delete': This command is used to delete a spectrum. Alternatively, a spectrum can be deleted by right clicking on it and then selecting **Delete** on the pop-up menu or by using the 'Delete' key while the spectrum is selected.

'Select All': Selects all spectra on the same page. This command is very useful when, for example, the user needs to apply the same processing to all spectra simultaneously.

'Alignment': The **Alignment** sub-menu is frequently used to neatly align spectra. To use the alignment toolbar, click on the spectra to be aligned and then press the alignment control desired. The alignment command will apply only to the selected spectra.

By clicking on this item, a sub-menu window will open and the user will be able to align (or otherwise manipulate) several selected spectra on the same page.



This menu will allow the user to **'Bring to Front'** or **'Send to Back'** a selected spectrum (or an object) as well as **'Bring Up'** or **'Bring Down'** it.

This menu allows the user to determine how items on a page (generally spectra) or items within a spectrum (chemical structures, titles, expansion spectra etc) are positioned with regard to overlapping.

The documents may have multiple layers, hence we have the commands **'Bring to Front'**, **'Send to Back'** as well as **'Bring Up'** (a level) or **'Send Down'** (a level). The tool **'Send to Back'** is also very useful to create 'semi-transparent' shapes, as you can see in the picture below:

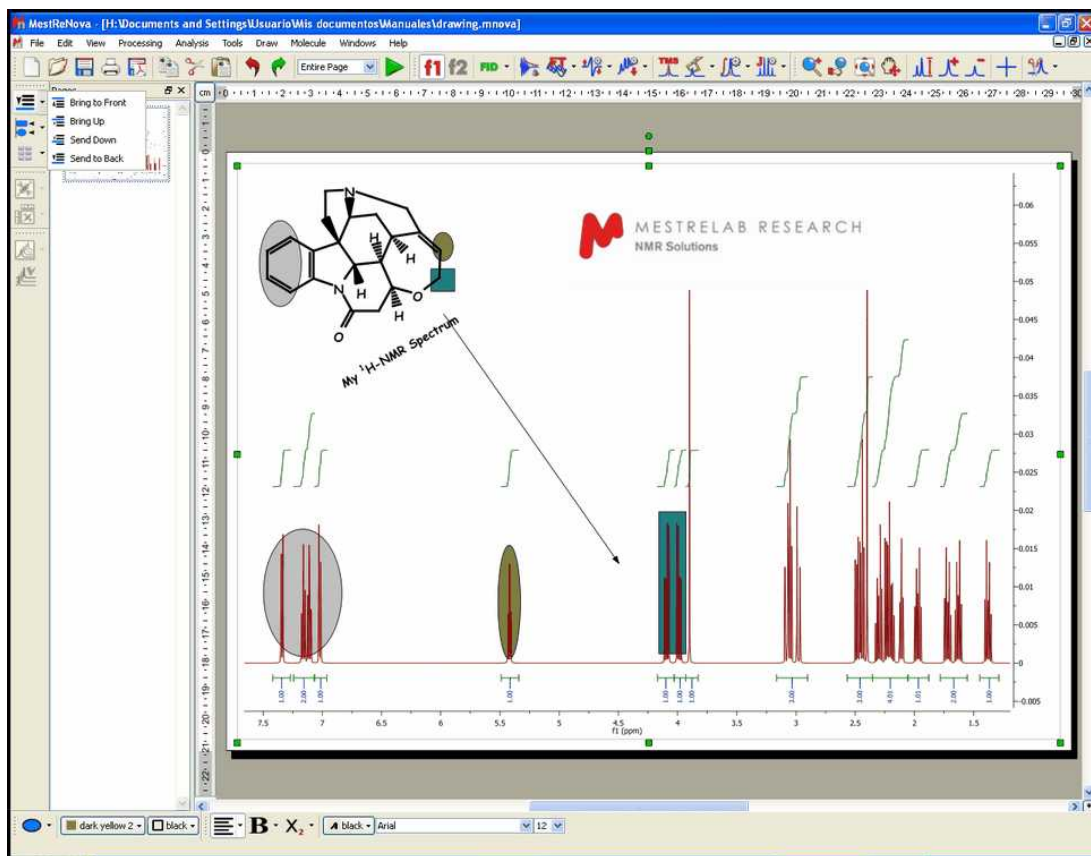

In the same way, the user can 'Align Left', Right, Top and Bottom, and 'Center Horizontally' or Vertically (applying this last operation with multiple objects selected will Superimpose them). The user can also center the selected spectrum (or spectra) on the page (vertically and horizontally). Finally the user can apply the functions 'Tile Vertically' and 'Tile Horizontally' to separate the spectra on the same page (as shown below).

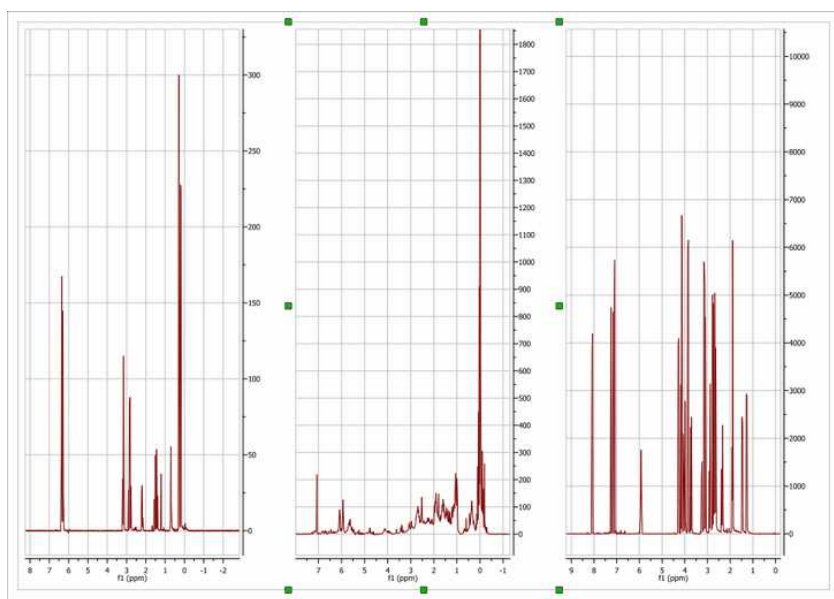

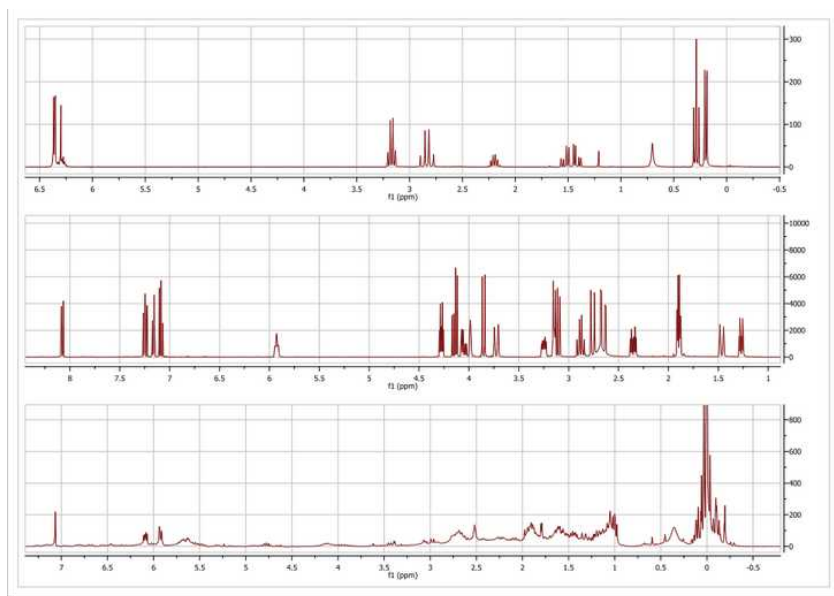

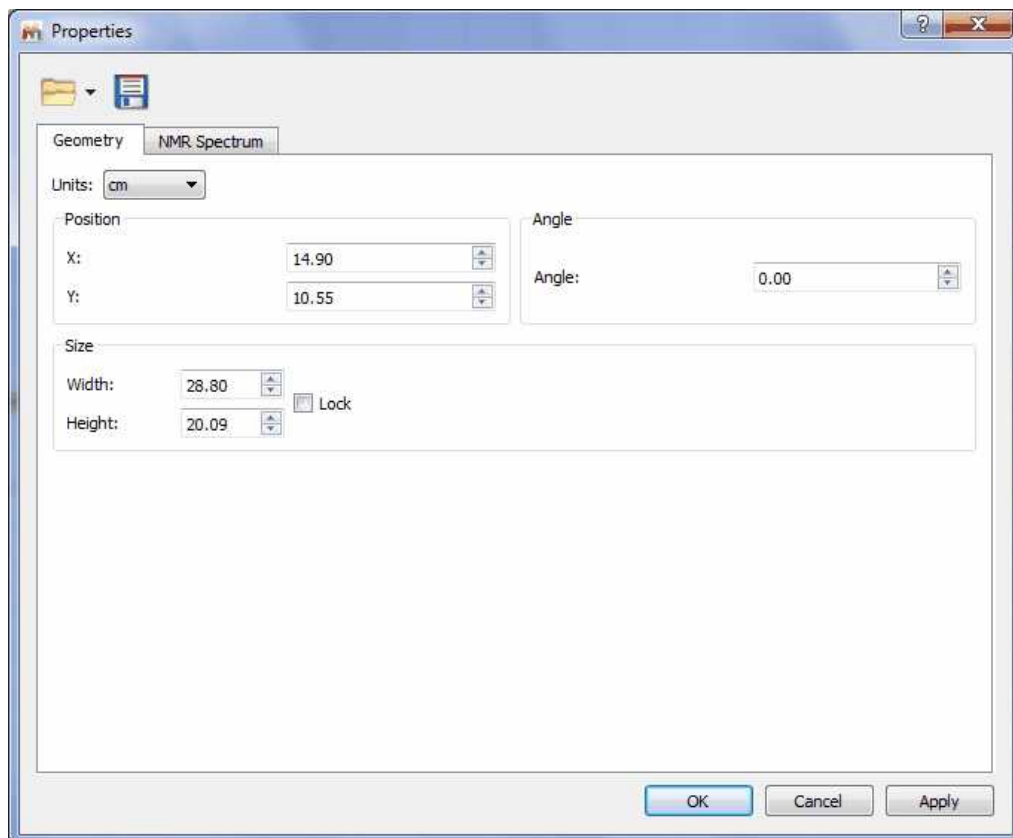

Alignment tools can also be found on the left vertical toolbar area.

Properties: Mnova will allow the user to customize nearly all the attributes of the spectrum. The user can select the properties of the spectrum by following the menu 'Edit/Properties' or by double clicking the left mouse button or pressing the right mouse button on the spectrum display and selecting 'Properties' from the *pop-up* menu.

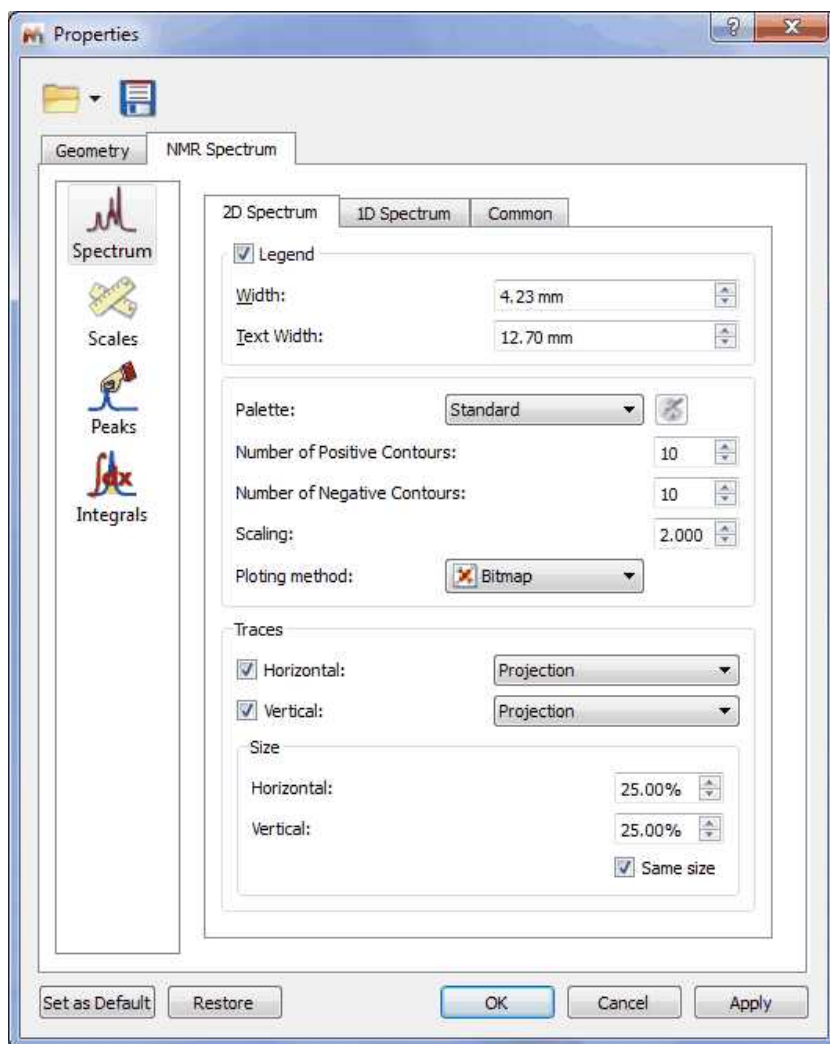



The user will be able to save his/her own properties just by clicking on the **Save Properties'** icon  (green square in the picture above). The Saved Properties will be opened by clicking on the '**Load Properties'** icon  (red square in the picture above).

We will not go into further detail here since all the property pages should be self-explanatory and a description of each one can be found in its applicable section of this manual.

Edit Page Title: It is possible to edit the title of the page shown in the page navigator just by right clicking on it and selecting 'Edit Page Title' or by following the 'Edit menu' (please bear in mind that the title of the spectrum can not be changed due to integrity reasons):

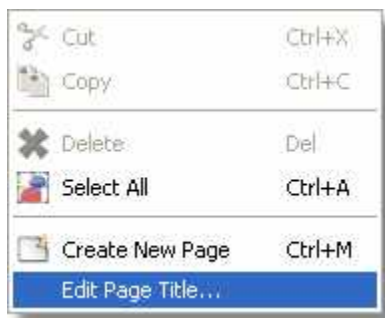

The 'Edit Page Title' dialog box will be displayed and you will be able to select or type the desired title of the 'Page'

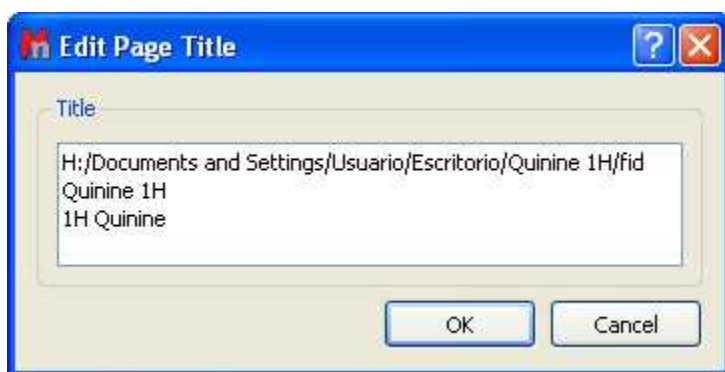

This window will contain the 'Data File Name', the 'Title' and the 'Comment' which appears in the Parameters Table:

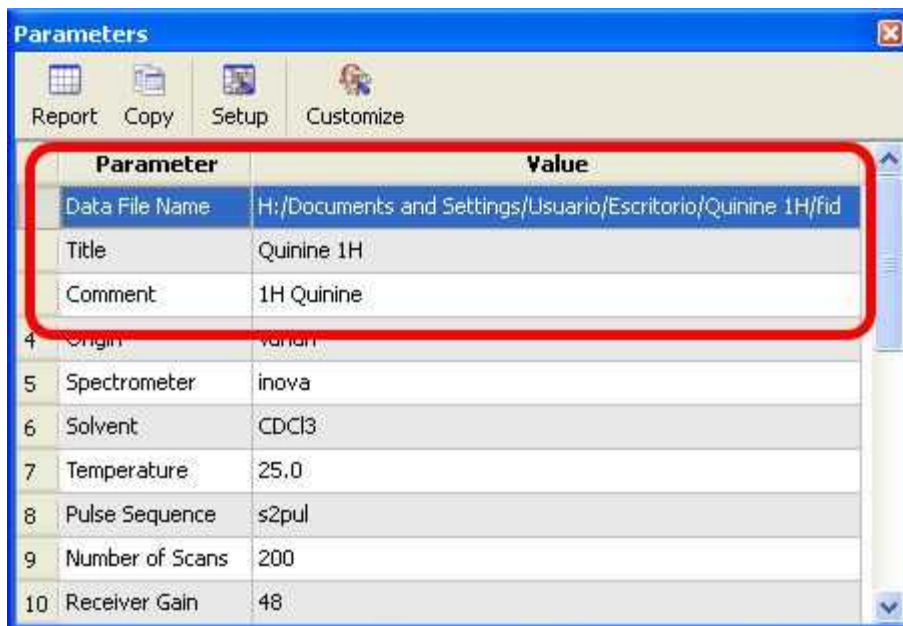

Please bear in mind that the comment of the 'Parameters Table' will be updated on the 'Edit Page Title' until you click on the 'OK' button of the 'Edit Page Title' dialog box (at this moment the comment will be fixed and the changes made in the 'Parameters Table' will no longer be updated to the 'Edit Page Title' window).

Options: From this window, you will be able to change the options of the Mnova Interface, plugins, NMR and drawing tools.

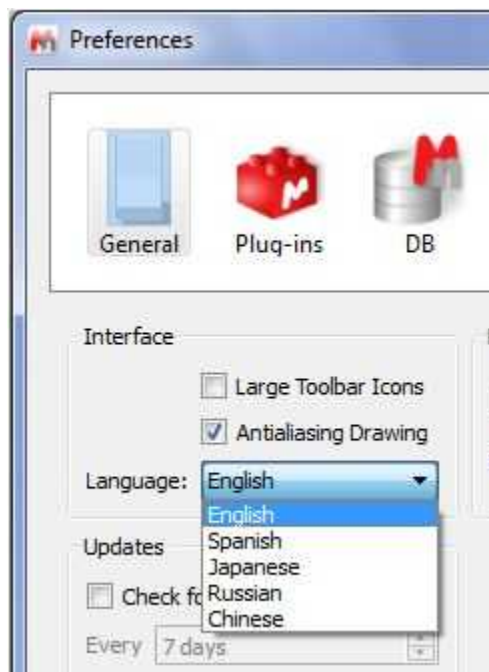

See also: [Options](#).

View Menu: The 'View' menu is where the user may select which toolbars, tables, rulers... are visible. In addition, it has other commands, such as:

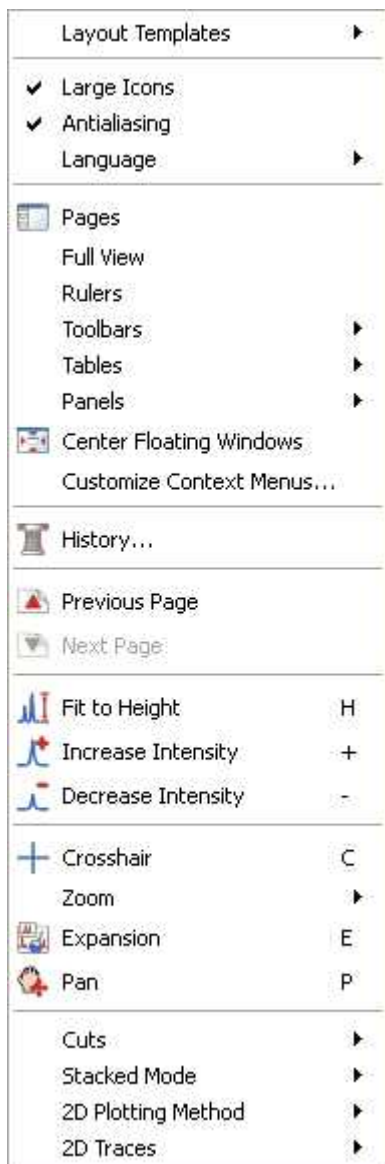

'Pages': This option allows the user to remove the page navigator (activated by default).

'Full View': (Not to be confused with 'Full Spectrum') will bring up a miniature view of the entire working document with the active area of the spectrum highlighted in blue, as you can see in the picture below:

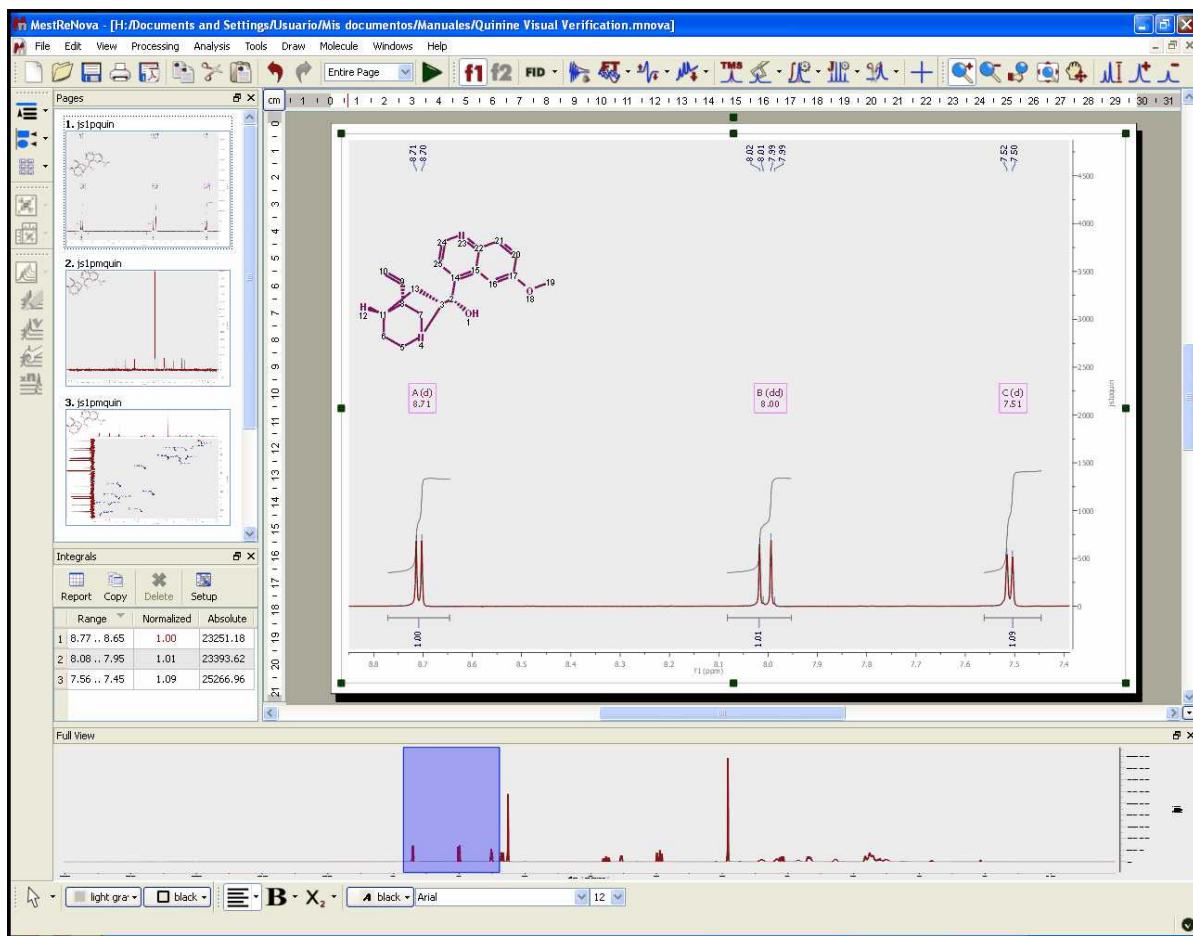

You will be able to toggle the Full View window by using the F2 key. This will allow you to get a 'Super Fast' panning.

See also: [Full View](#).

'Rulers': Click here to show or hide the rulers.

'Toolbars': This item of the 'View' menu allows the user to select which toolbars are visible on screen. Click the name of a toolbar to select it for display. Click again to deselect. You can attach a toolbar to any side of the graphical interface by dragging it to where you want it attached.



'Main':

This toolbar contains the standard file operations 'New', 'Open', 'Save', 'Print Tools' and 'Export to PDF', the editing operations 'Copy', 'Cut', 'Paste', 'Undo' and 'Redo', and the 'Page Width' drop-down menu which will be fully described in the zooming chapter.



'Alignment': Contains all the alignment tools. These commands are duplicated on the 'Edit' menu.



'NMR Processing': This toolbar contains the most frequently used NMR processing tools..

The 'f1' and 'f2' commands are used to set the processing frequency dimension (f1 or f2).

'FID': It is possible to see the **original FID** or the **processed FID (FID')** by clicking on the appropriate sub-menu item on the FID-icon side-bar. There are several further options in the scroll-down menus which will be fully described in the [Processing Chapter](#).

'Apodization' (or *window function processing*): Windowing is a technique for manipulating the FID to either remove the "sinc" wiggles from the peak bases resulting from the truncation of the FID (apodization) or optimize the spectral resolution or remove various other acquisition artifacts or any combination of the above. You can find a full description of this tool further on in the [Fourier Transform](#) chapter.

'FT' : This command transforms the time domain FID into the frequency domain spectrum. It will be described in detail in the [Fourier Transform](#) chapter.

'Phase Correction': This process adds constant ('Zero Order') and linear (First Order about the pivot point) phase to the spectrum in order to obtain pure phase line-shapes. If you click on this icon, Mnova will carry out an automatic phase correction. This process will be described further in its applicable chapter (**'Phase Correction'**).

'Baseline Correction': This is a very important processing step to obtain good quality spectra, with all the signals connected by a flat line. Mnova will apply an automatic baseline correction if the user clicks on this icon. If you are interested in studying **'Baseline Correction' in Mnova** in depth, please refer to the applicable chapter in this manual.

'Reference' : Click on this icon to calibrate your spectrum by assigning the position of an internal standard (such as TMS or a solvent peak). Mnova offers you a list of the most common deuterated solvent chemical shifts to calibrate the spectrum. Again, you can find a full description of this tool further on in the **'Chemical Shift Referencing'** chapter.

'Peak Picking': Clicking on this tool will select all the peaks in the spectrum using a default threshold, mark them, indicate their chemical shifts and tabulate the shifts. You can find an advanced description of this tool in the [applicable chapter](#).

'Integration': Integration is used to estimate the number of species (e.g. protons) associated with a peak in the spectrum. Manual and fully automatic routines are available. Please read the **'Integration'** chapter for more information about this tool.



'NMR Zoom' :
functions:

This toolbar contains the following

'Zooming': This tool is used to expand the spectral regions on screen. Mnova incorporates several ways of zooming, such as zoom in, manual zoom, full spectrum, and panning.

'Fit to Height' and **'Increase and Decrease Intensity'**: These tools scale the data of your NMR spectrum

'Crosshair': These two orthogonal lines forming a crosshair are available on the 'View' menu (or by pressing the <c> key) for reporting positional information, and for help in visualizing peak alignments.

'Cutting': Allows the user to hide regions of the spectrum, when they are of no interest. These tools are fully described in later chapters.



'2D NMR' : This toolbar contains the plotting methods for 2D NMR display. Mnova incorporates four 2D-NMR spectra representation modes. The most commonly used mode is the 'Contour Plot'. This representation provides a good global view of the data points and allows a precise location of all signals (except the weakest). Nevertheless, the relative intensities and the multiplet structure of many signals can be difficult to interpret. In the following picture, a section of a spectrum in Contour Plot is shown:

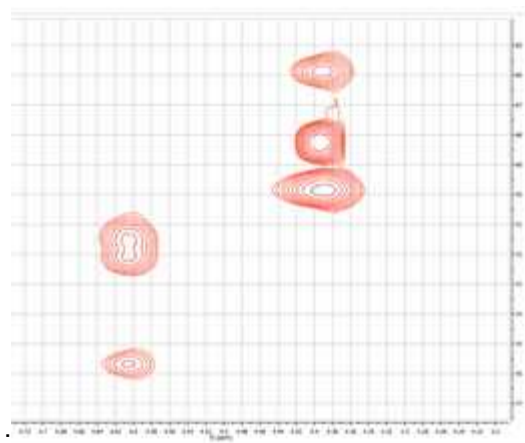

A faster alternative in computational terms is the 'Bitmap Plot'. Mnova uses this representation as a default mode; the intensity of each point is represented by a colored scale, thus making relative intensities easier to interpret. If only positive intensities are plotted, the color scale is from red (high intensity) to blue (low intensity). In the figure below, you can see a spectrum shown in Bitmap Plot:

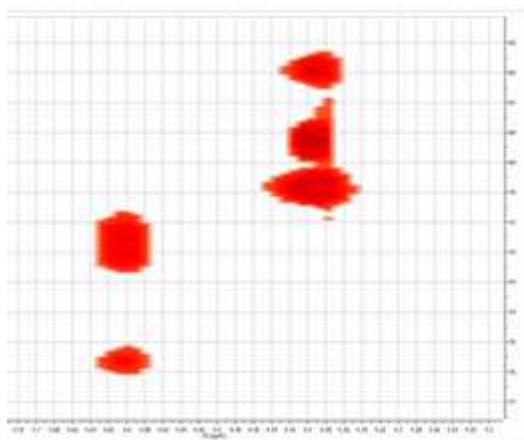

A **'Stacked Plot'** provides a *pseudo-3D* visualization of the data. This kind of representation is useful for revealing weaker signals and for comparing the intensities of different signals in the spectrum. A stacked plot is shown below:

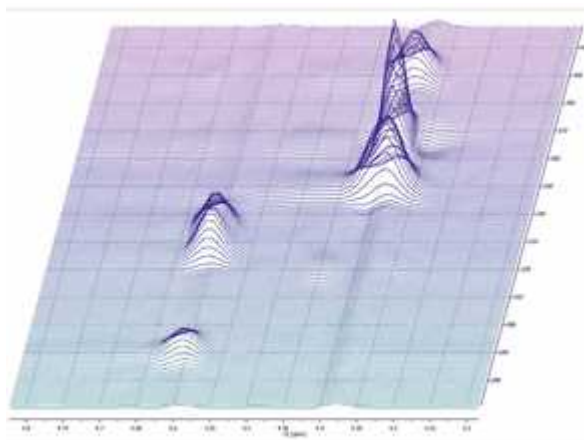

'Whitewashed Stacked Plot': In the called 'Stacked Plot' mode, all the individual traces that compose a 2D experiment or an arrayed experiment are superimposed on each other, so it can be difficult to obtain a clear view. However, this problem can be avoided using the **'Whitewashed Stacked'** mode. In this mode all the individual traces are plotted, but the traces are not "transparent", so that the characteristic 3D look is obtained. The contrast between the 'Stacked Plot' and '

'Whitewashed Stacked' modes can be appreciated in the figure below.

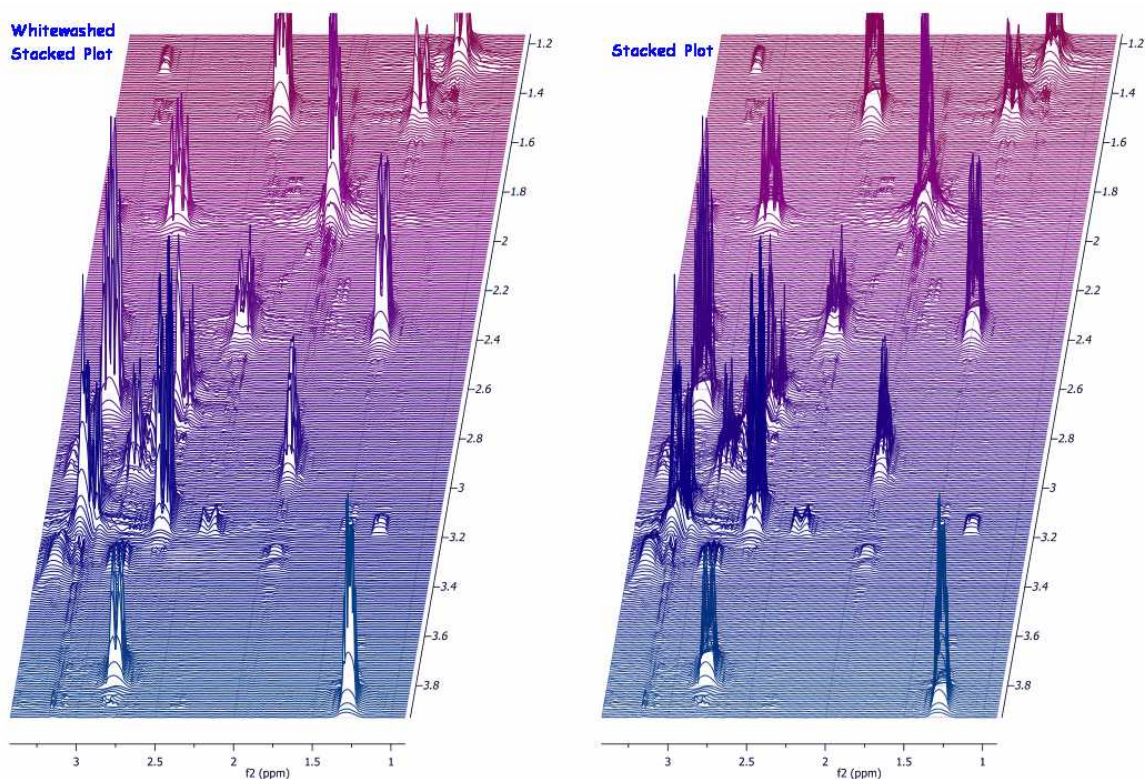

'**Show traces**': this tool allows the user to show and setup the vertical and horizontal traces of a bidimensional spectrum. The user can increase or decrease the intensity of the traces simply by scrolling the mouse wheel (windows only for the moment) after hovering the cursor over the desired trace. To move the trace hold the Shift key down while scrolling the mouse wheel over the trace.



'**Stacked NMR**': Mnova includes a general-purpose fitting module designed to analyze stacked experiments such as relaxation, kinetics or DOSY experiments, using a robust but intuitive working environment. The user can find a full description of this tool further on in the [Stacked NMR](#) tutorial.



'**Drawing**': You can draw an object by using these tools. You can choose the line color (default is black) and the fill color (default is light grey).



'**Drawing Text**': The text tool allows you to enter text with different formats. You can also find more information about drawing tools further on in ['Graphics and Annotations'](#) chapter.

'**Tables**': Mnova groups all spectra-relevant information into the so-called '**Tables Window**', available from the **View** menu. This option allows the user to see the spectral parameters (Acquisition Parameters are selected in the figure below), or Peaks (shown in the blue square), Integrals (in the red

ellipse) or any of the other parameter classes as indicated on the tabs at the lower edge of the window.

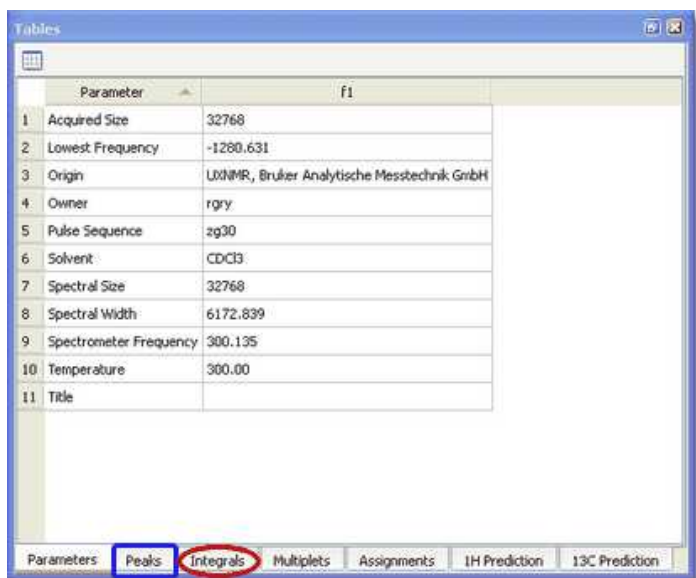

	Parameter	F1
1	Acquired Size	32768
2	Lowest Frequency	-1280.631
3	Origin	LDXNMR, Bruker Analytische Messtechnik GmbH
4	Owner	rgry
5	Pulse Sequence	zg30
6	Solvent	CDCl3
7	Spectral Size	32768
8	Spectral Width	6172.839
9	Spectrometer Frequency	300.135
10	Temperature	300.00
11	Title	

See also: [Tables](#)

'History': This tool opens a list of the previous operations applied to the spectrum. The document history saves a list with all the changes (with date and time) which the user has applied since the file was opened. This command is very useful if you have a saved file but you do not remember the steps you took in processing it.

'Previous and Next Page': These commands are used to scroll through the page navigator. Of course, the user can use the 'Page Up' or 'Page Down' keys to obtain an identical result.

The user can also select the desired spectrum by simply clicking on it on the page navigator (and then, can navigate to the previous or the next by using the up or down arrow keys). The rest of the 'View' Menu has already been explained above.

Processing Menu: The Processing menu allows the user to select which tools should be applied when processing the NMR spectrum. The user can also find the most frequently used tools in the toolbar.

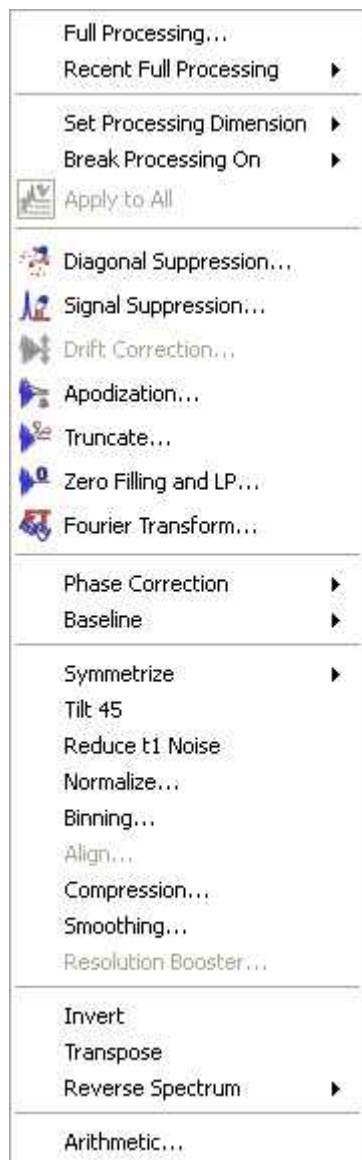

'Full Processing': This tool allows the user to automate the full processing of both 1D & 2D NMR data sets. The user can find a full description of this tool further on in the [Automated Processing](#) chapter.

'Recent Full Processing': You can find here the most recent Full Processing archives.

'Set Processing Dimension': The user can choose the dimension (f1 or f2) to apply the processing.



This tool is also present in the NMR process toolbar.

'Break Processing On': By default, when a new dataset is opened and time domain data (a 'fid' file for example) are selected, Mnova immediately applies appropriate fid pre-processing (Apodization) followed by Fourier transformation. If you wish to intervene in this process 'Break Processing On' allows you to halt the processing when, for example, the raw data are loaded, so that you can adjust apodization, zero filling, linear prediction or the Fourier transform parameters before continuing processing. (This is fully described further on in the [1D NMR Processing](#) chapter)

The following commands are described in more detail in the [Processing Basics](#) chapter:

'Diagonal Suppression': This option is used to remove the signal on the diagonal from homonuclear spectra. Mnova applies this tool automatically prior to the FT.

'Signal Suppression': This tool is used to remove any undesired signal such as a solvent resonance, from the spectrum.

'Drift Correction' : This tool is used to remove the spurious peak which may appear at the transmission frequency when the the integral of the FID is non zero. The transmission frequency is known as "o1" on Bruker spectrometers and as "sfrq" on Varian instruments. Some texts refer to this as "Zero Frequency" but quadrature detection ensures that we don't have to deal with negative frequencies.

'Apodization': This is used to remove the so-called "Sinc Wiggles" which can appear at the base of peaks when the FID has been truncated. Generally a decaying exponential "window function" is applied to the truncated FID to 'force' the FID to zero.

'Truncate': This technique may be used to shorten the acquisition data time series. If the FID, for example, decays to zero in 0.5 seconds and the acquisition time was 2 seconds, the FID consists of 25% signal and 75% noise. Since both 0 and a 90 degrees phase shifted spectra are collected a time series data length of twice the FID time is required for maximum information content. Truncating the FID at about 1.0 second will reduce the amount of storage required with no data loss. At a later time Zero Filling may be used to cosmetically adjust the spectrum's appearance.

'Zero Filling and LP': Zero Filling allows FID time series data which has just decayed to zero at the end of the acquisition time to be extend by one further "acquisition time" by appending zero data points equal in number to those in the FID. This avoids the data loss which normally would result when half the data points are assigned to the "imaginary" part of the frequency spectrum optimizes frequency resolution of the spectrum. Zero filling beyond this point only improves the digital resolution of the lines which can still be useful although no new data is revealed.

LP (Linear Prediction) can be used to approximate a complete FID when data are missing from the start or the end of the transient. Typically if the FID has been truncated and has not decayed to zero by the end of the acquisition time, LP may be used to predict, based on the existing data, the missing (truncated) data. This is an alternative to applying a severe window function to avoid the peak-base (sinc) oscillations or wiggles caused by a sudden change in the FID. The "synthetic FIDs" obtained along f1 in indirectly observed 2D experiments are almost always truncated and linear prediction can be applied to very good effect.

'Fourier Transform': Transforms the *time-domain signal* (acquisition data) into a frequency-domain representation (spectrum)

'Phase Correction': Mixes the real and imaginary components of the spectrum in order to obtain pure phase lineshapes. During the detection process the receiver reference signal's phase may differ from that of the magnetization vectors by a fixed amount. This may be corrected by adding or subtracting a constant phase shift to the transformed data (the Zero Order phase correction).

The delay after the last transmitter pulse until the receiver becomes active allows the magnetization vectors to evolve slightly according to their chemical shifts, introducing a frequency dependant phase shift which may be corrected by the First Order phase correction.

'Baseline': This tool attempts to connect all the spectral signals by a horizontal line.

'Symmetrization': This function, used in homonuclear correlation spectroscopy, replaces all signals which are symmetrically positioned about the diagonal by the smaller of the two signals. In this way unsymmetrically positioned noise and artifacts are removed. This technique should be used with

caution since any symmetrical noise or artifacts will be preserved and may be mistaken for genuine signals.

'Tilt 45': This technique is most frequently used with homonuclear J-resolved spectra where the effect of couplings in the f2 dimension is not required.

'Reduce t1 Noise': This function reduces the streaks of noise parallel to f1 which often accompany strong 2D signals and are due to instrument instabilities.

'Normalize': The intensity of 1D NMR spectral signals is generally displayed in intensity units based on the instrument's receiver digitizer's maximum range in bits. Normalization allows the intensity to be displayed in terms of some spectral feature such as the height of the tallest peak or some arbitrary peak or the total spectral area. In most cases post-acquisition signal suppression (Processing/Signal Suppression) is needed to remove solvent signals.

Normalization can be used to investigate the manner in which the intensities of some signals are changing from one sample to another while other signals remain constant. Examples include chemical kinetics and pharmaceutical drug degradation studies.

'Binning': Chemical processes within cells are often tracked through the study (metabolomics) of the small-molecule metabolites produced. Typically many 1H spectra are taken and studied statistically. To render the many data points in a typical spectrum tractable they are "binned" into around 200 bins (or buckets) and each bin is integrated. Thus from the original spectrum a metabolic "finger print" is extracted for further analysis.

Binning is a technique used in metabolomics to reduce the many data points in a typical 1H spectrum to a small number of representative values.

'Compression': This tool is used to reduce the size of spectral data with minimal loss of information. This is useful when many spectra must be taken and stored for possible later analysis.

'Smoothing': This technique is used to reduce the effect of noise on a spectrum and possibly reveal signals embedded in, or distorted by, noise. Noise contains rapid fluctuations which are generally faster than the rates of change of genuine signals. Smoothing applies a low-pass filter to the spectral data to remove these rapid fluctuations while having minimal effect on signals.

'Resolution Booster': A new frequency domain post processing method which yields a considerable resolution enhancement.

'Invert, Transpose and Reverse': Invert effectively adds 180 degrees of constant phase to the entire spectrum.

Transpose switches the axes in a 2D experiment. In a heteronuclear 2D Bruker place f2 horizontally while Varian place it vertically. The user of one vendor looking at the other's data would be more comfortable with the spectrum transposed.

Reverse switches the spectral data around the transmitter (excitation) frequency. This might be required to correct data that had been incorrectly processed. A peak at x ppm below the transmitter frequency will appear at x ppm above the transmitter frequency after applying 'Reverse'.

'Arithmetic': to carry out arithmetic operations with or processed spectra.

7.4 Intelligent NMR Clipboard

The clipboard is for sure one of the most useful features in any modern Operating System and it is used for short-term data storage and/or data transfer between documents or applications, via copy and

paste operations. Any modern application should support clipboard operations and, of course, [Mnova](#) is no exception. However, Mnova goes one step further compared to other applications as I will try to show in this post.

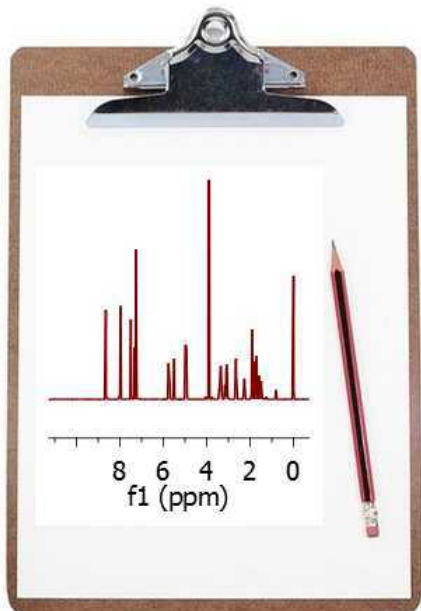

Following the same principles as standard Office applications, with [Mnova](#) it's possible to copy any object (e.g. spectra, molecules, etc) into the clipboard and paste it either in Mnova (for example in a different page) or in any other application such as MS Office. The peculiar thing is that once a spectrum has been transferred to the clipboard (via Ctrl+C), it is possible to 'paste' it into another spectrum. Three simple examples will illustrate this new feature.

Example #1

You have processed a spectrum and integrated carefully in order to quantify some signals of interest. Next you realize that you also want to integrate a different spectrum but using exactly the same integral regions as those in the first spectrum. There are several ways to do that in Mnova, but a very simple one involves copying the first spectrum into the clipboard and then selecting 'Paste Properties/ NMR Integrals' from the Edit menu. You can paste these integrals either to a single spectrum or to a bunch of selected spectra (or pages). The same can be used for the peaks

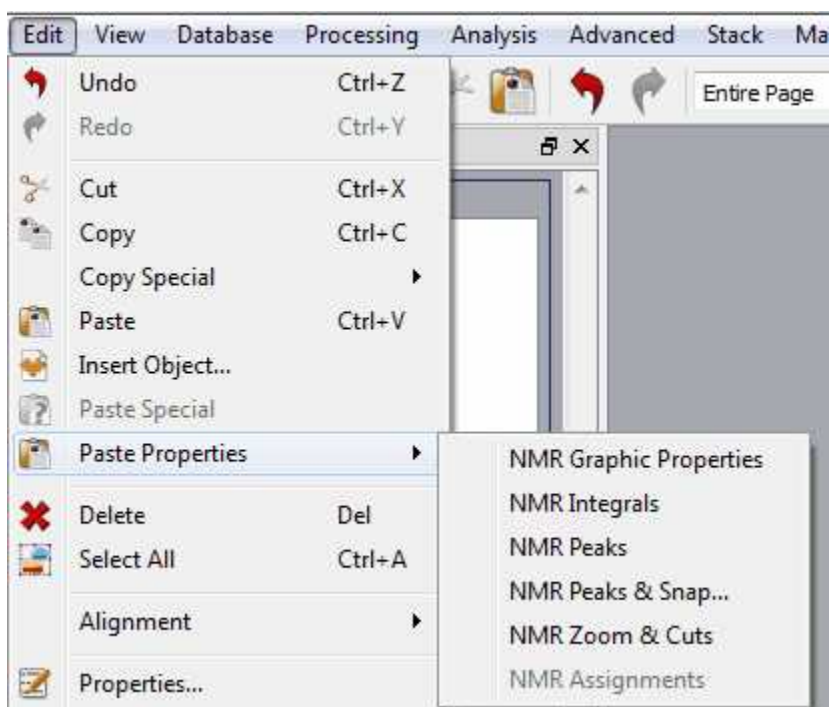

Example #2

You have customized the graphical properties of a spectrum (e.g. fonts, colors, grid, etc) and you find that you want to rapidly apply the same graphical settings to another spectrum. Once more, this is very easy with the clipboard: copy the first spectrum (Ctrl+C) and then select the target spectrum and issue command 'Paste NMR Graphic Properties'.

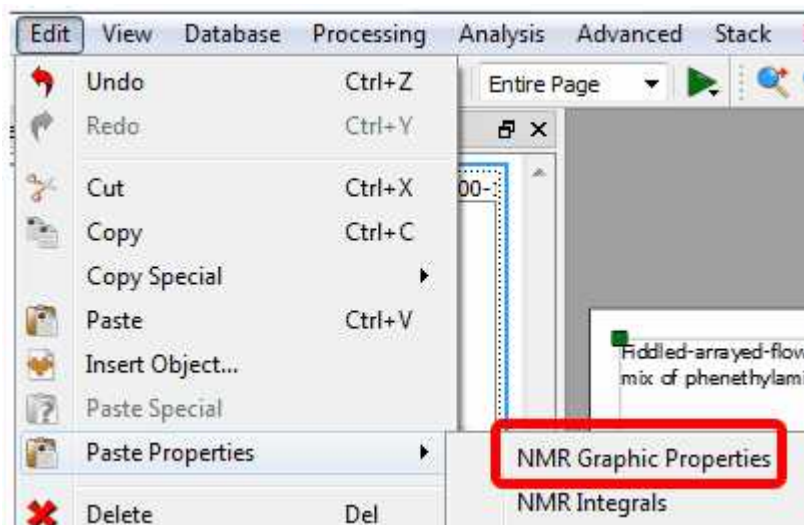

Example 3 (NMR Peaks & Snap)

When copying the peaks to a new spectrum, Mnova has an option to automatically snap the peaks to its nearest peak. A peak that would be automatically picked using the current peak picking threshold. For this option, the user is able to define a chemical shift window (the maximum chemical shift changes expected in f1 and f2).

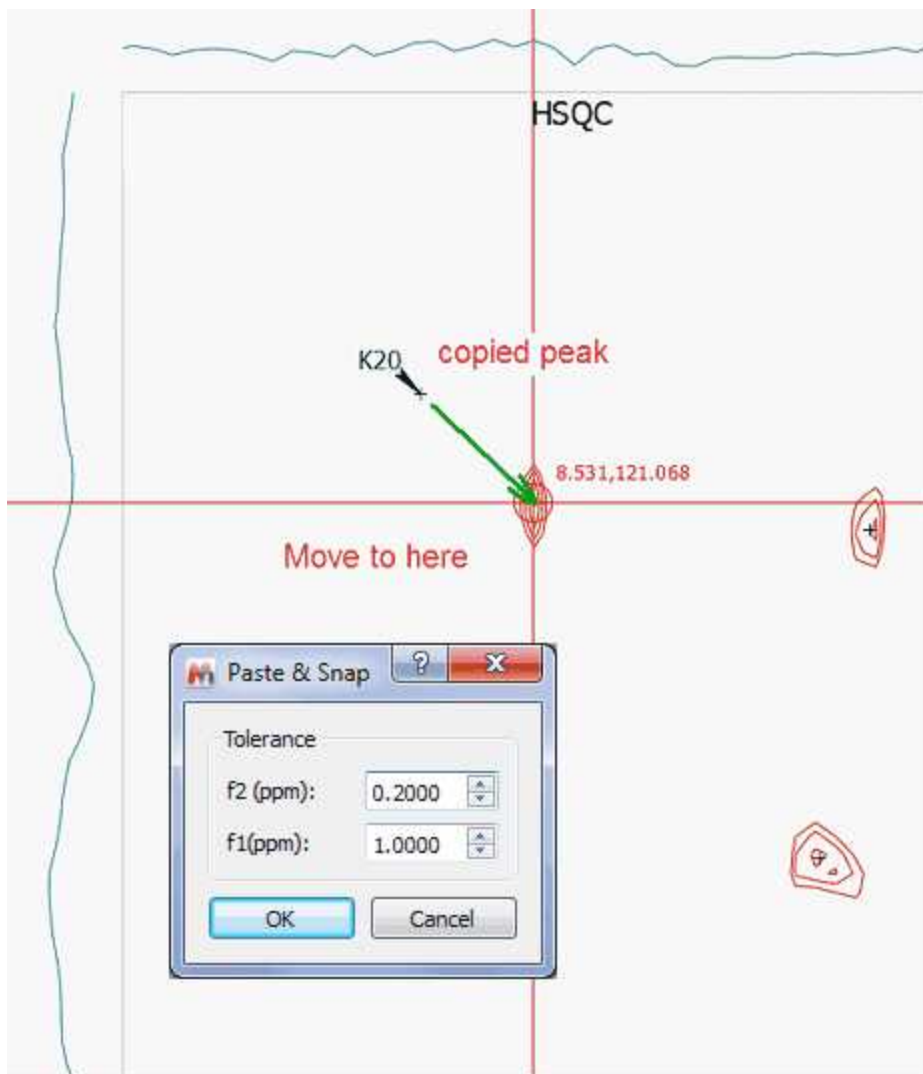

Mnova also allows the user to click-drag and move a peak label to a new location, by using the 'Move Peaks' tool under the Peak Picking scroll down menu.

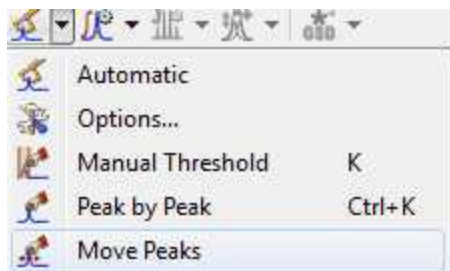

Example 4 (Zoom&Cuts)

This option will be used to copy the zoom and cuttings from one spectrum to another (or others).

Example 5 (NMR assignments)

This feature will copy the assignments from one molecule to another. The mechanism will be: Ctrl+C in the assigned molecule, followed by clicking on the new molecule and applying 'Edit/Paste Properties/NMR Assignments' command.

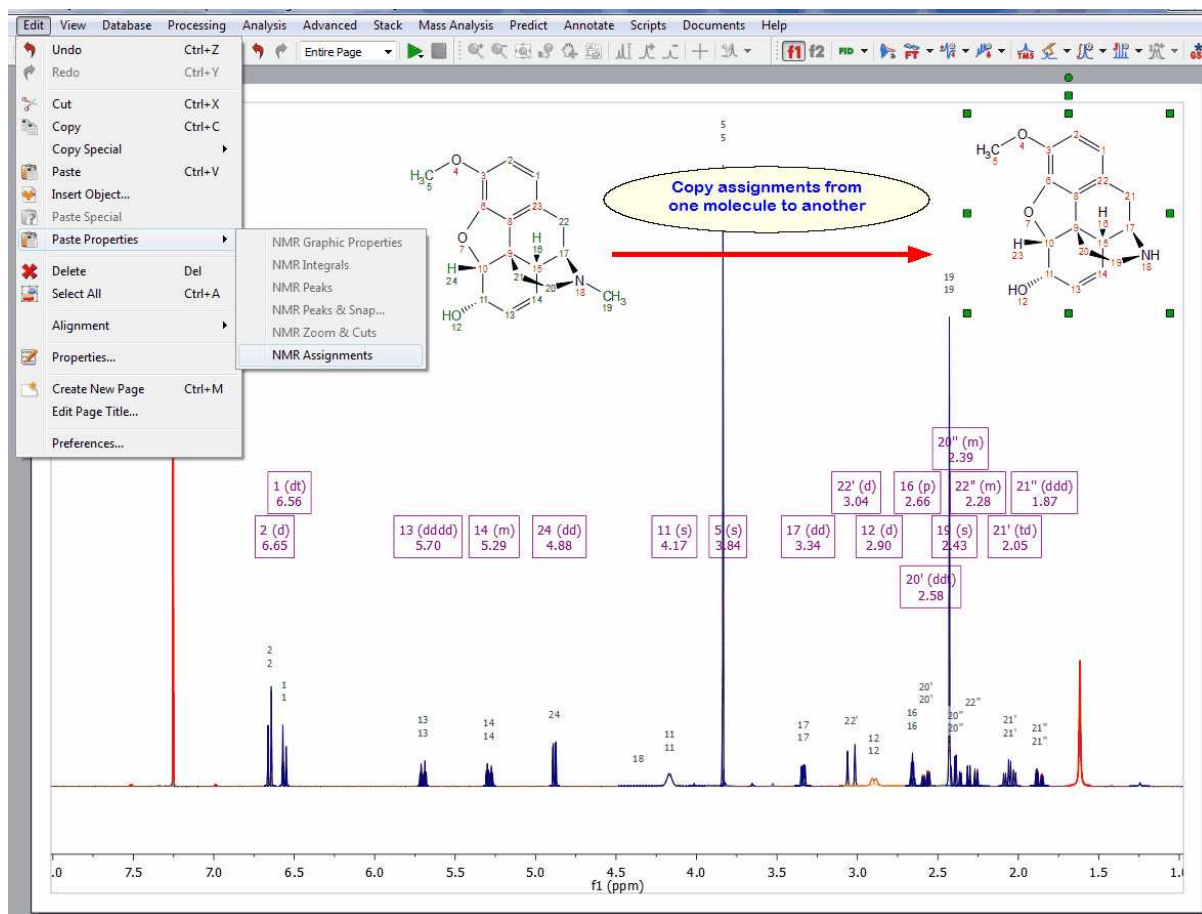

7.5 Properties

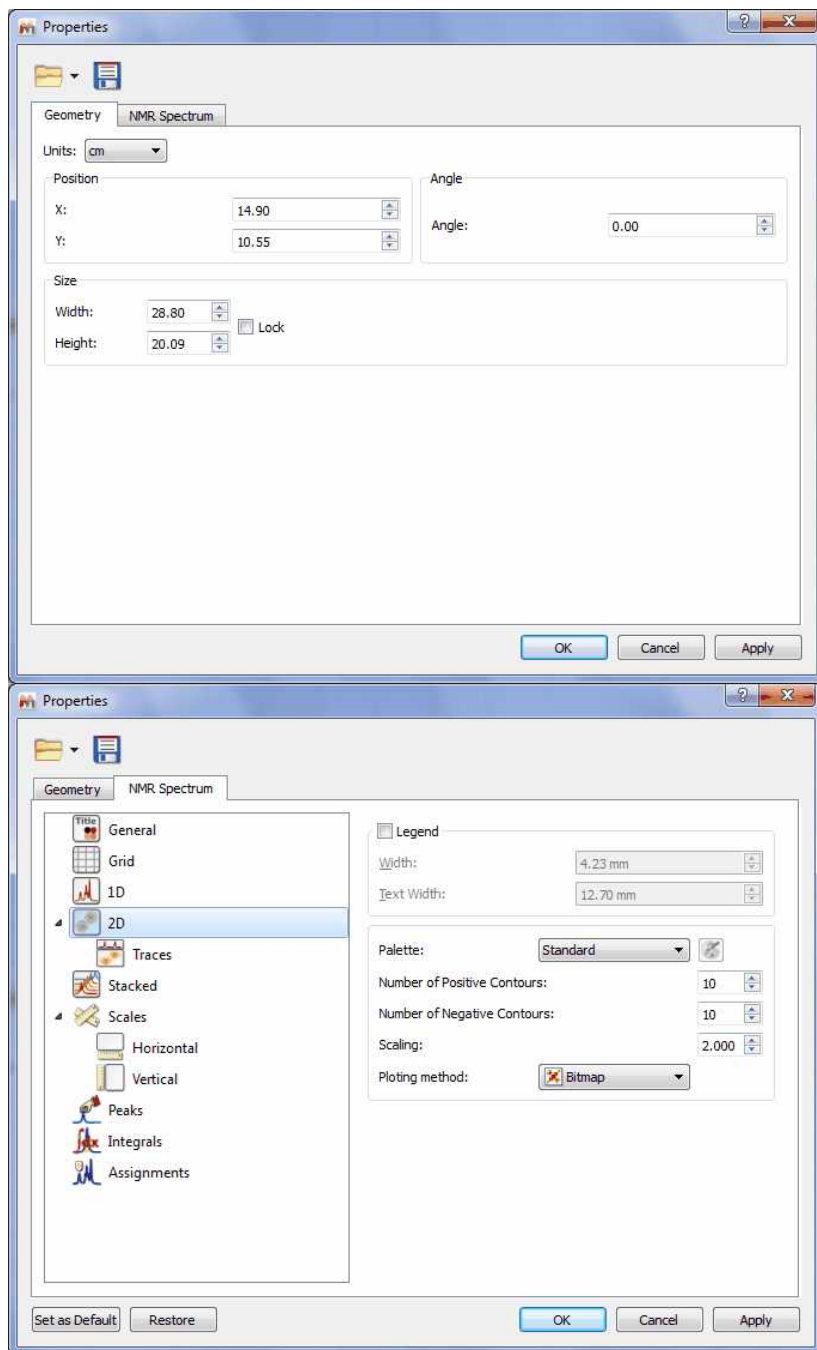

Properties: Mnova will allow the user to customize nearly all the attributes of the spectrum. The user can select the properties of the spectrum by following the menu 'Edit/Properties' or by double clicking the left mouse button or pressing the right mouse button on the spectrum display and selecting 'Properties' from the *pop-up* menu.

You can see in the pictures below the geometry and the Spectrum properties of a 2D NMR experiment.

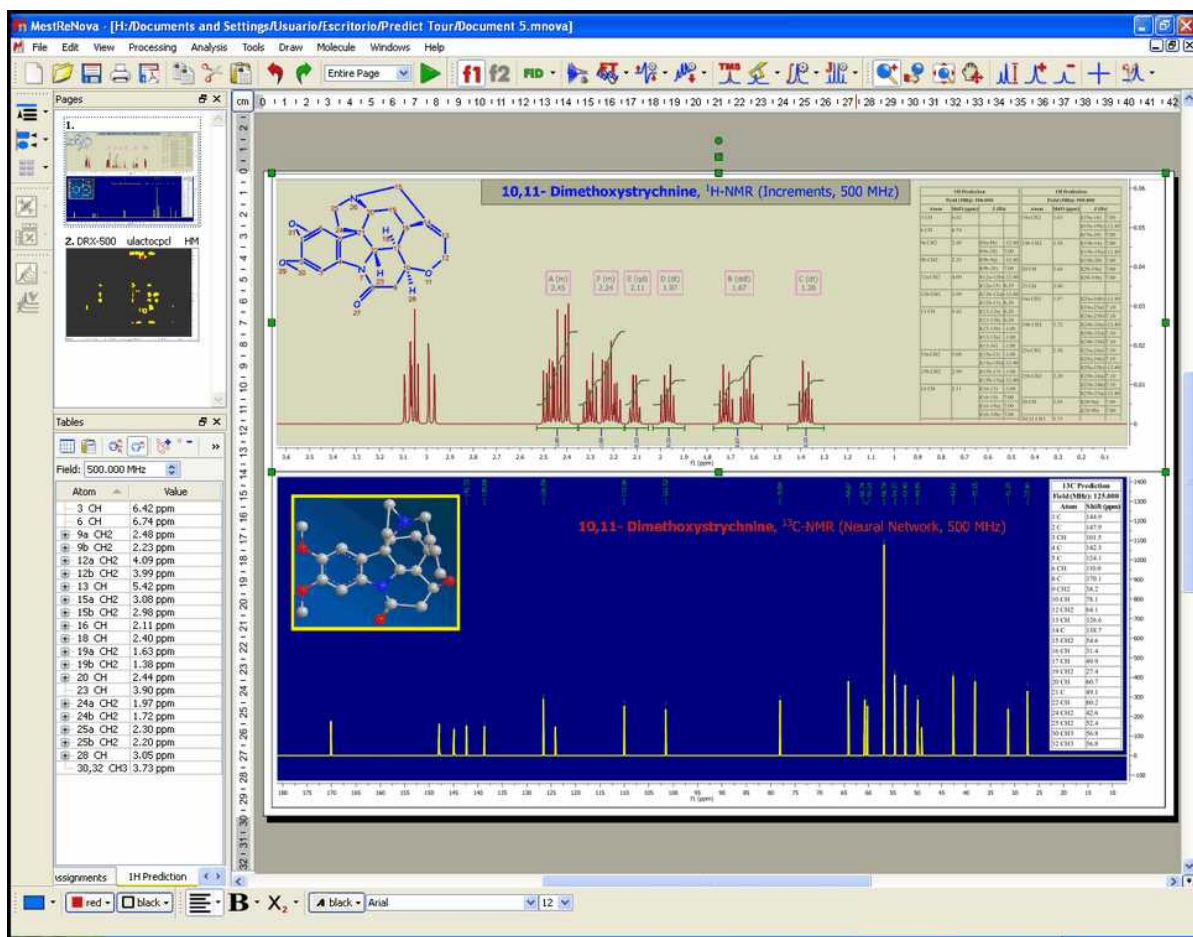

From this set of tabbed pages you can change, for instance, the spectrum's geometry (position, angle, size), the traces size, the **'Background'**, the **'Line-Style'** (line, crosses or circles), the **'Line Colour'** and the **'Line Width'**. Bear in mind that a **'Line Width'** of zero indicates a *cosmetic pen*. This means that the *pen* width is always drawn one pixel wide, independent of the transformation set on the painter . In 2D NMR spectra, you can set the legend, the number of contours, plotting method, show traces and customize the palette. The user can also set the scales' properties, change the grids, the aspect of the axes and margins or the units (ppm, Hz, points, seconds), for a more convenient representation of the spectrum. It is also possible to easily change the color of the spectrum background to suit your eyesight, your working hours, or your mood. Enjoy complete freedom on how to present your data! Transparency is also supported! Here you can see an example:



It is also possible to **show the title on your spectrum** just by checking the 'Title' check box of the 'Spectrum/Common' properties. You can also customize the format of the title just by clicking on this icon . This will display a dialog box where you will be able to add 'Line Breaks', desired 'Parameters' of the Parameters Table e.g. (Title, Comment, Solvent, Owner, etc). From here you can also select the Name, Dimension, Max Length or Position. You can also add any 'Path' (with the capability to select the Level, Max Length or Position) or the 'Spectrum Number', just by selecting it on the 'Available Macros' panel and clicking on this icon  to add it to the title. Finally click on OK.

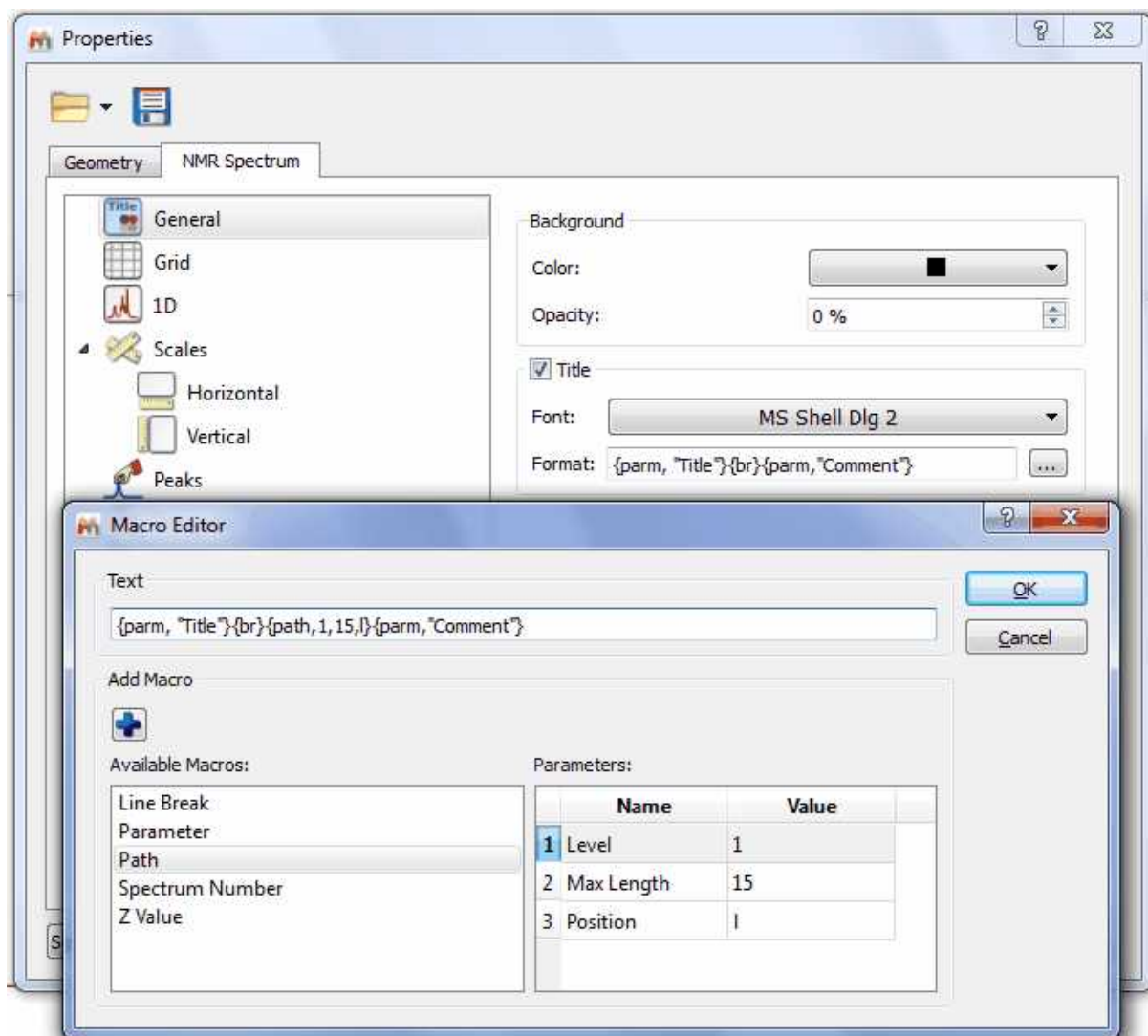

Here you can see an example where we have changed the font of the title and added several parameters (Title, Solvent, Comment, Pulse Sequence and Temperature) to the title of the spectrum:

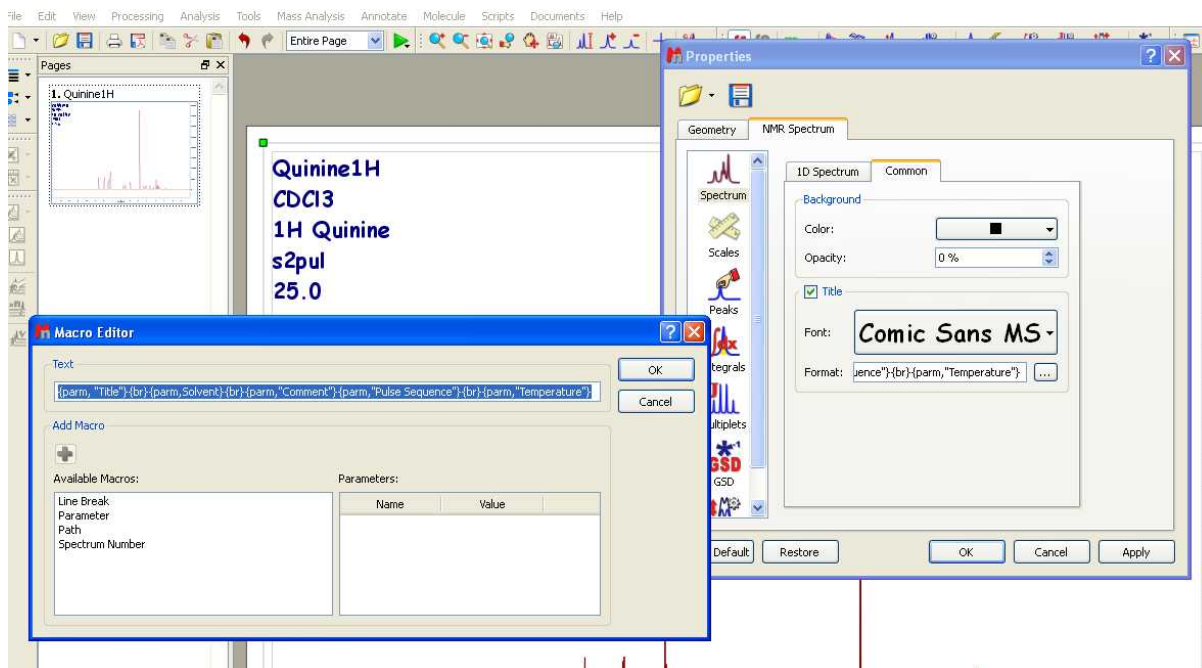

The user will be able to select the desired 2D spectrum palette and also customize his own palette by selecting for example 'Custom 1' in the 'Palette scroll down menu and then clicking on the **'Palette**

Editor' button  to display the **'2D-Spectrum Palette'** dialog box, where the user will be able to customize the desired palette (Name, Level Growth, Colors, Number of Levels, etc..). It is also possible to select the number of the positive and negative contours and also the scaling (in the 'Properties' dialog box) as you can see in the picture below:

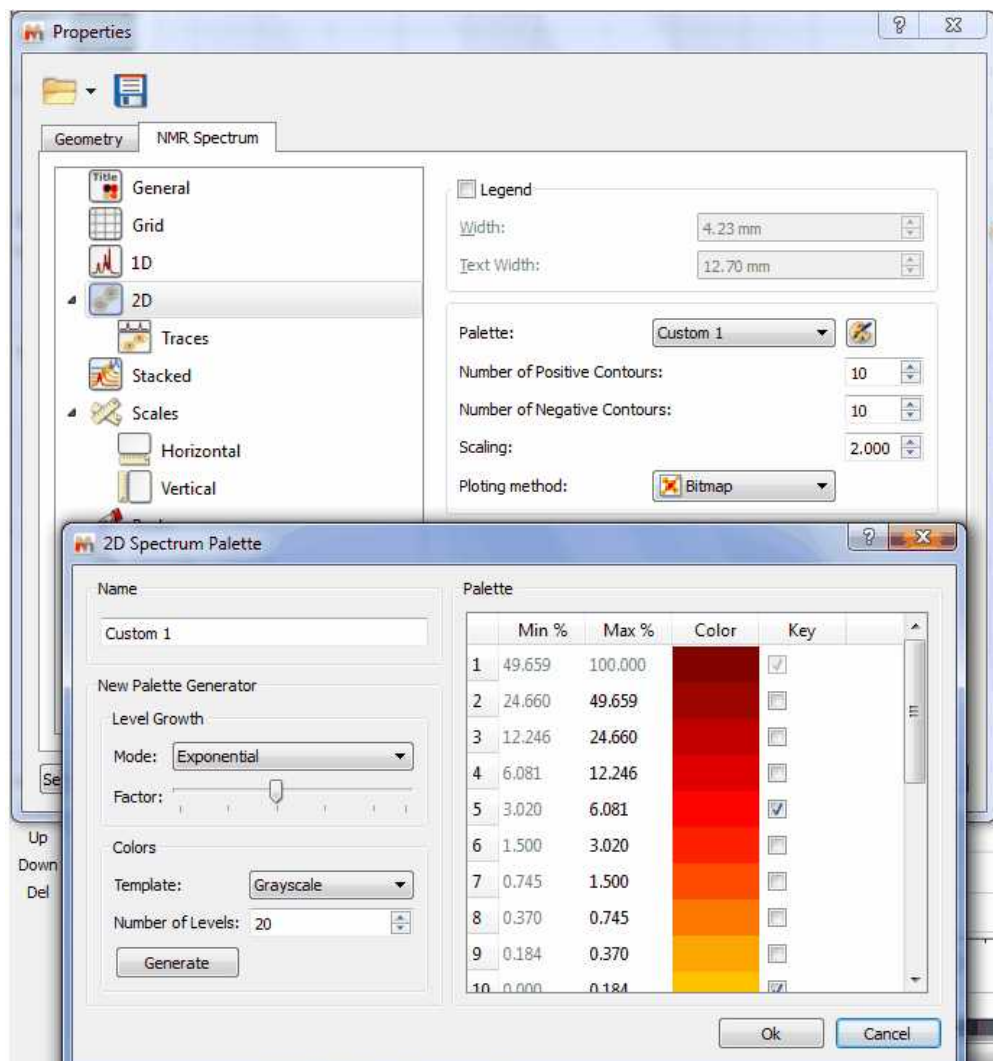

If you want to obtain monochrome printouts different with the ones that already exist in the Palette scroll down menu, please follow the procedure below to create a palette in pure black with no grayscale:

1. Run Mnova and load your 2D-NMR spectrum.
2. Double click on the spectral window to open the 'Properties dialog box'
3. Select 'Custom 1' on the 'Palette' scroll down menu
4. Click on the 'Palette Editor' button (just at the right side of the scroll down menu)
5. Select 'Grayscale' on the 'Template' colours scroll down menu
6. Click on the 'Generate' button
- 7a. If you have 10 levels, check the 10th level of the palette and then click on the light-grey rectangle (just at the left side of the check mark) and select the black colour. Finally click on 'OK' buttons.
- 7b. If you have 20 levels, do the same with the 20th level and so on...

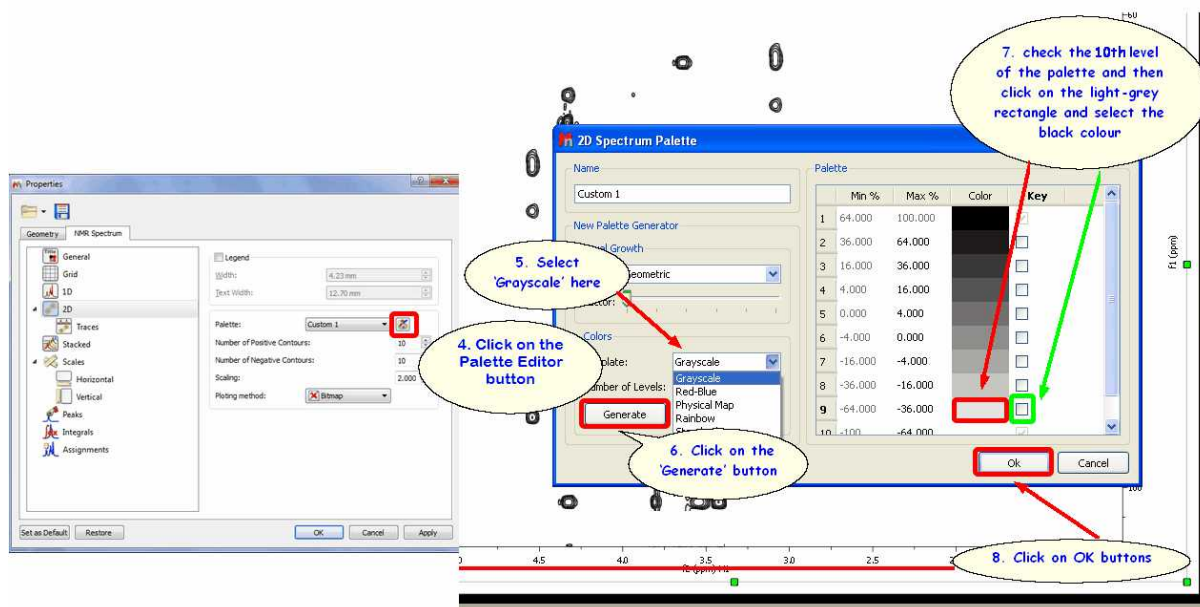

Let's take a look at another situation: how to make all positive contours a scale of greens and all negative contours a scale of blues?

In this case, you will only need to select in the '2D Spectrum Palette' dialog box the first and the last colour of the positive peaks and the same for the negatives. For example, imagine that you have 10 positive contours, then you will need to select the colour of the contour 1 as 'dark green' (for example) and then check the applicable mark at the right side. Finally, select the colour of the contour number 10 as 'light green' and check the mark. Do the same for the negative peaks; in this case the contour number 11 will be 'light blue' and the number 20 will be 'dark blue'. Please take a look at the screenshot below for further information.

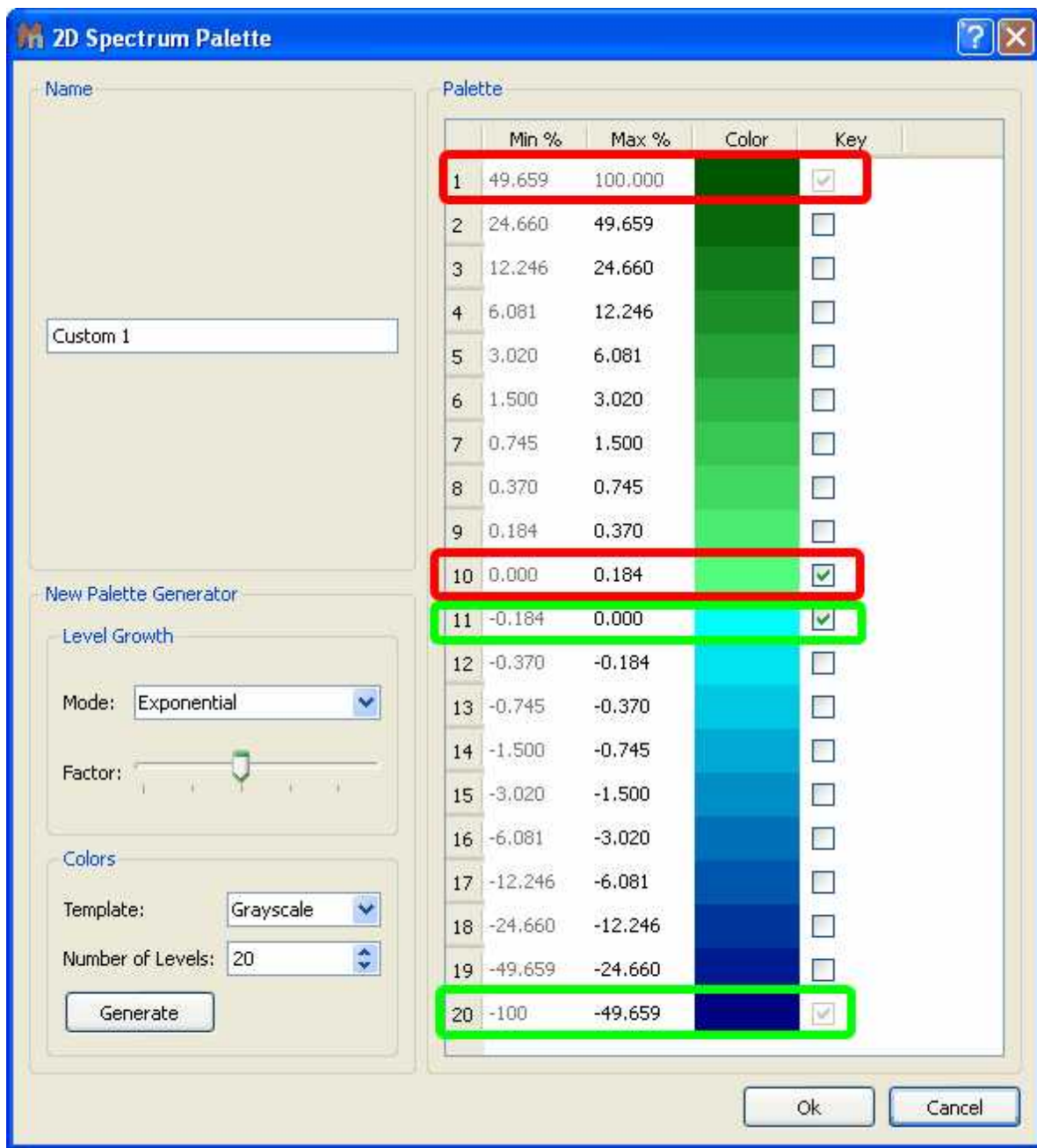

You can see below an expanded signal after having applied the resulting palette (obtained in the previous step):

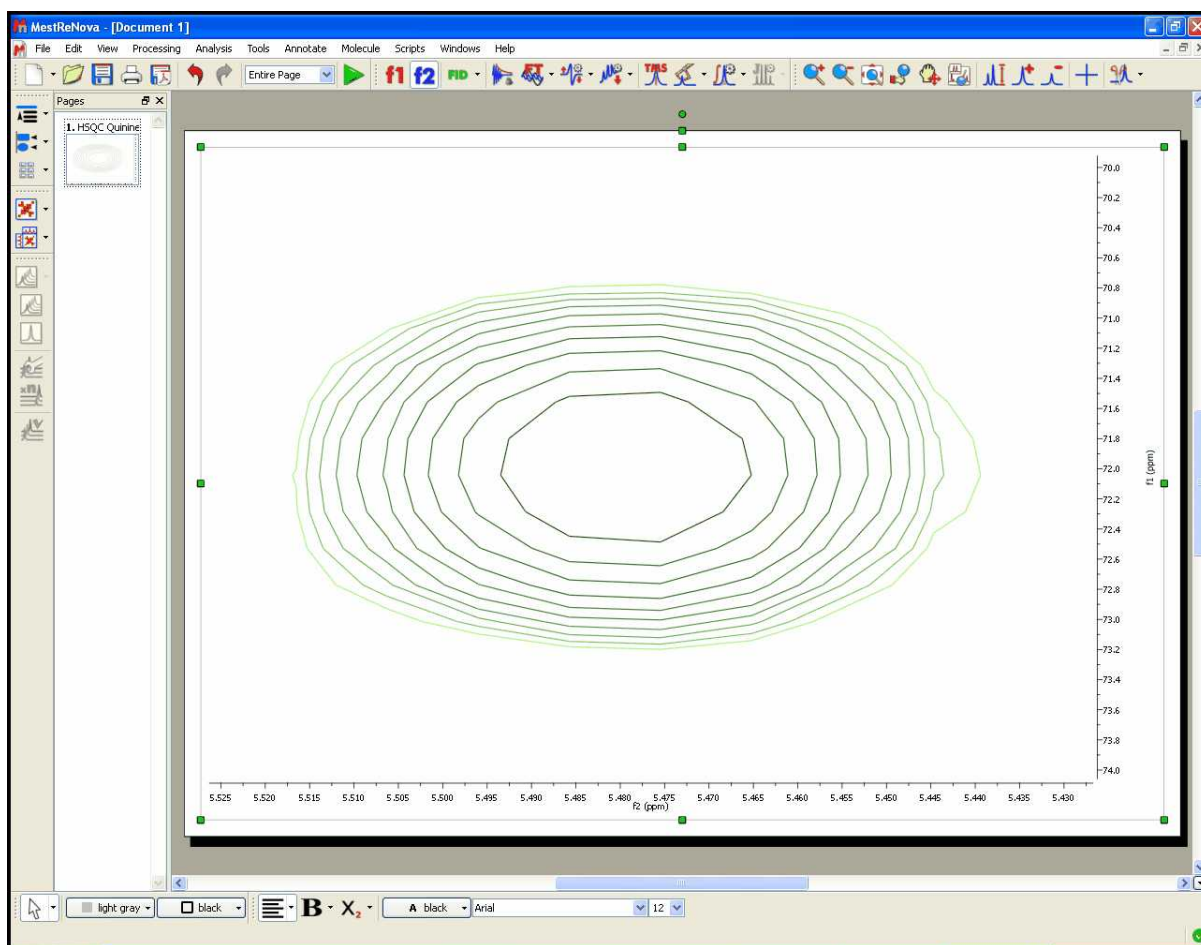

It is also possible to change the colours of the 2D overlaid spectra by following the above procedure (but changing the colours). You will find below two overlaid spectra with different colours (one red and the other purple). Please bear in mind that you can move from one spectrum to another (in the overlaid) by holding down the 'Shift' key and using the arrow keys (or the mouse wheel):

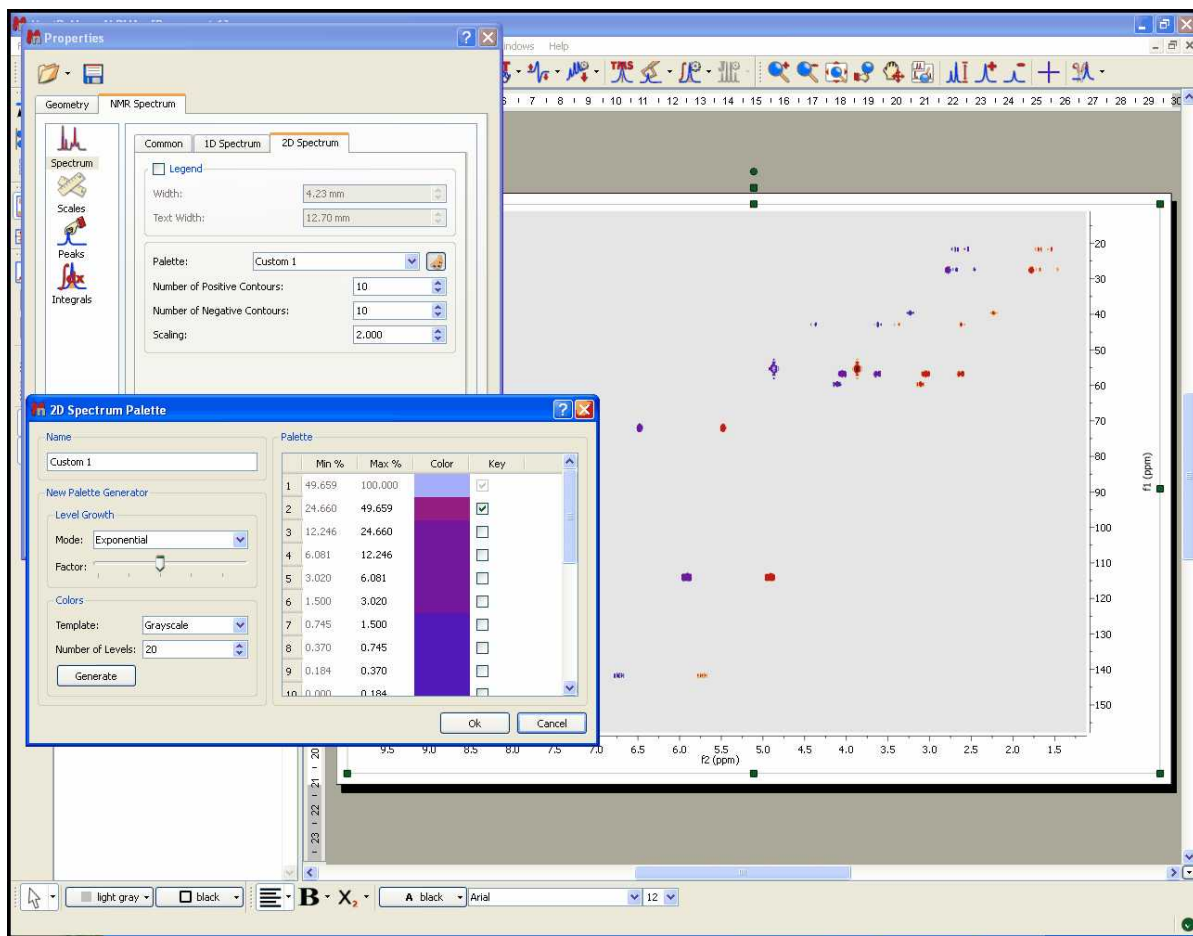

Of course, you can also make your 2D spectrum with a single color (no ramp). Once you are in the 'Palette Editor' dialog box, double click on the coloured rectangle of the level number 1 and select the desired colour, do the same with the level number 10 (bear in mind that you select the same colour) and uncheck any other key mark that could be in the other levels:

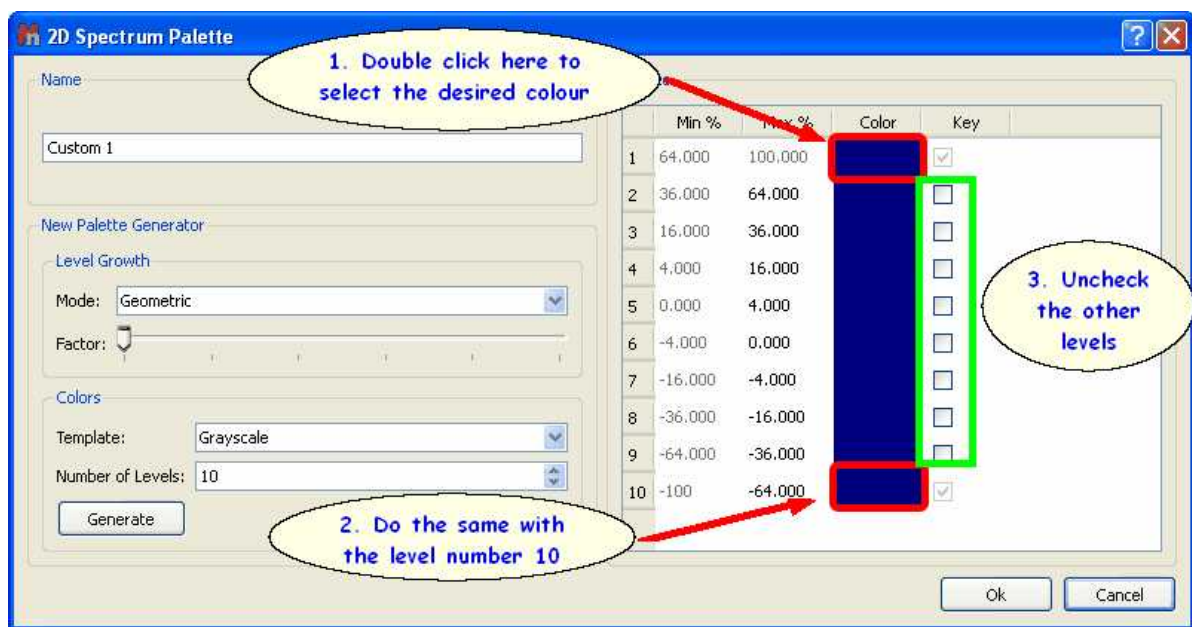

It is also possible to change the 'Scale Properties':

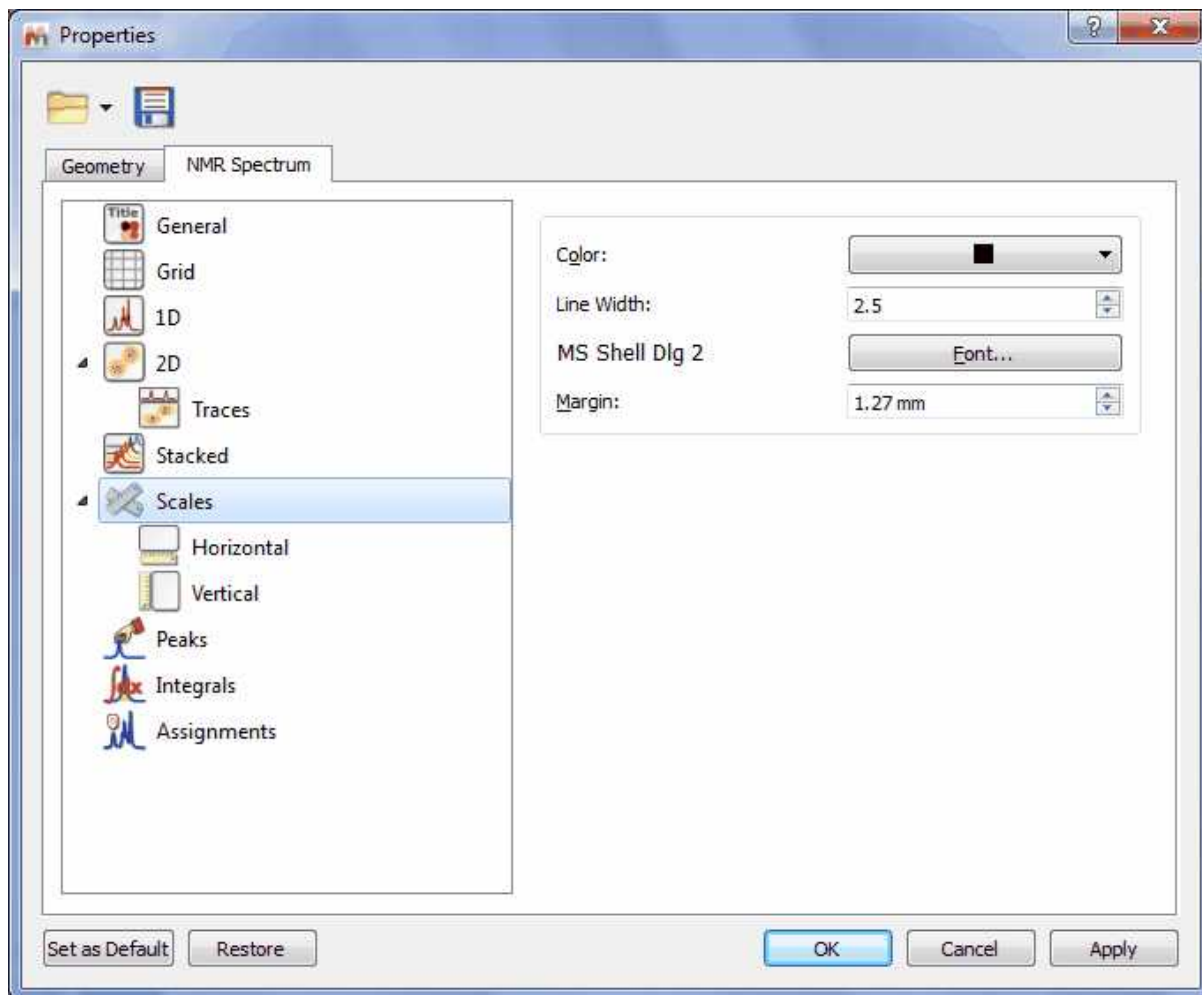

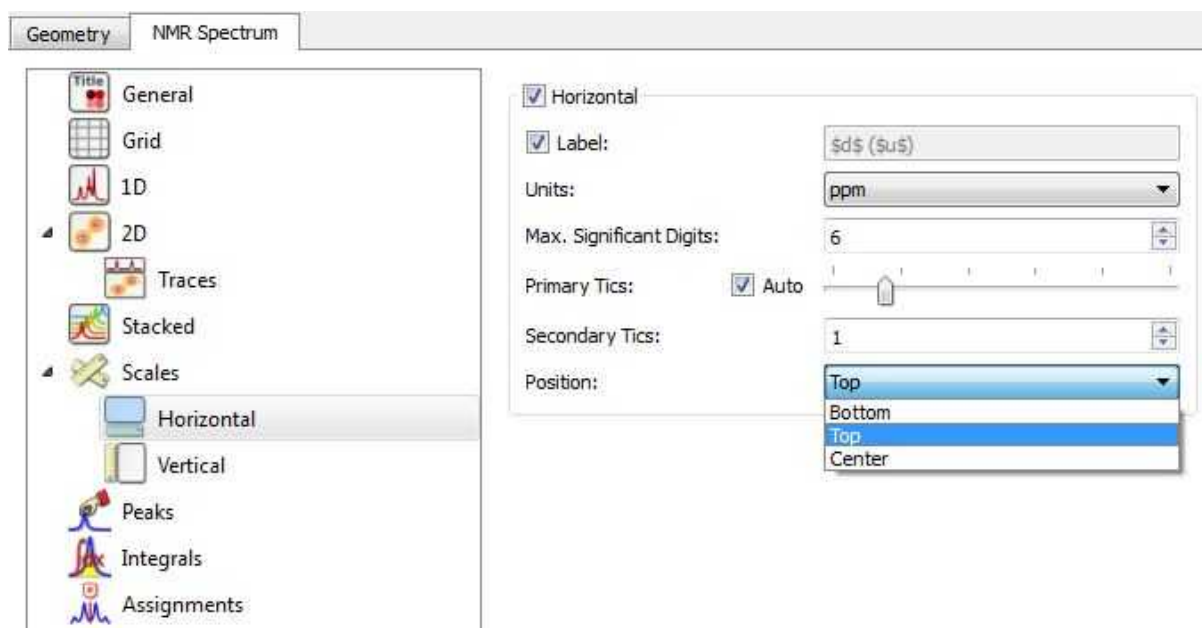

From here the user can change the properties of the horizontal and vertical scales:



The user can include the spectrum title (the title set previously on the spectrometer at acquire time) on any axis label by typing '\$t\$' in its applicable edit box. Bear in mind that, Mnova will only show the first line of the original title. This title appears by default on each page of the page navigator.

Hovering the cursor over the label edit box will reveal other commands for including information on the axis label, such as: \$u\$ = Lowercase Units; \$U\$ = Uppercase Units; \$d\$ = Lowercase Dimension; \$D\$: Uppercase Dimension; or \$1n\$ = Observed Nucleus (e.g. 1H, 13C...).

It will be also possible to select the Maximum significant digits and the number of Primary and Secondary tics of the scales and to select the position of the scales.

The user will be able to save his/her own properties just by clicking on the **Save Properties**' icon  (green square in the picture above). The Saved Properties will be opened by clicking on the **Load Properties**' icon  (red square in the picture above). It is also possible to set the current properties as default by clicking on the 'Set as Default' button. Clicking on the 'Restore' button, will restore the predefined properties.

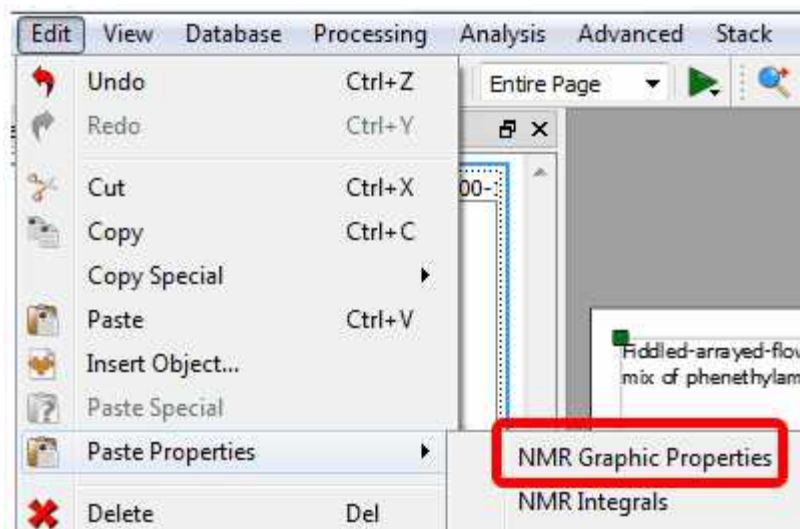

The user can also modify many other features such as the parameters and properties of the peaks or integrals. We will not go into further detail here since all the property pages should be self-explanatory and a description of each one can be found in its applicable section of this manual.

For example: once any table has been reported, it is possible to change its properties (position, size, fill and border) just by double clicking on it:

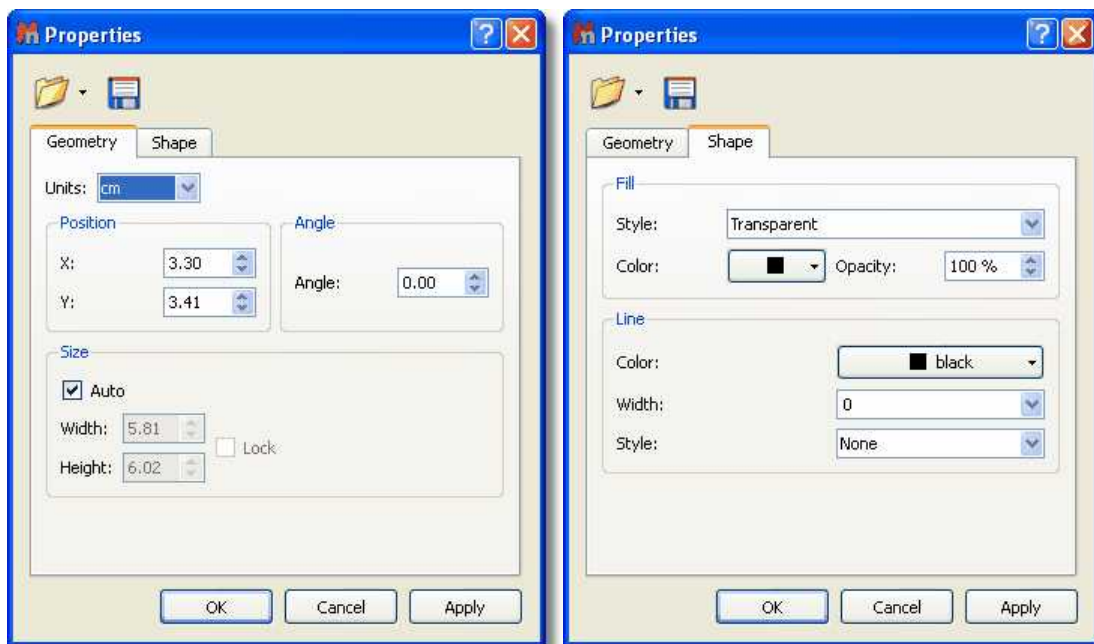

Or for the molecules:

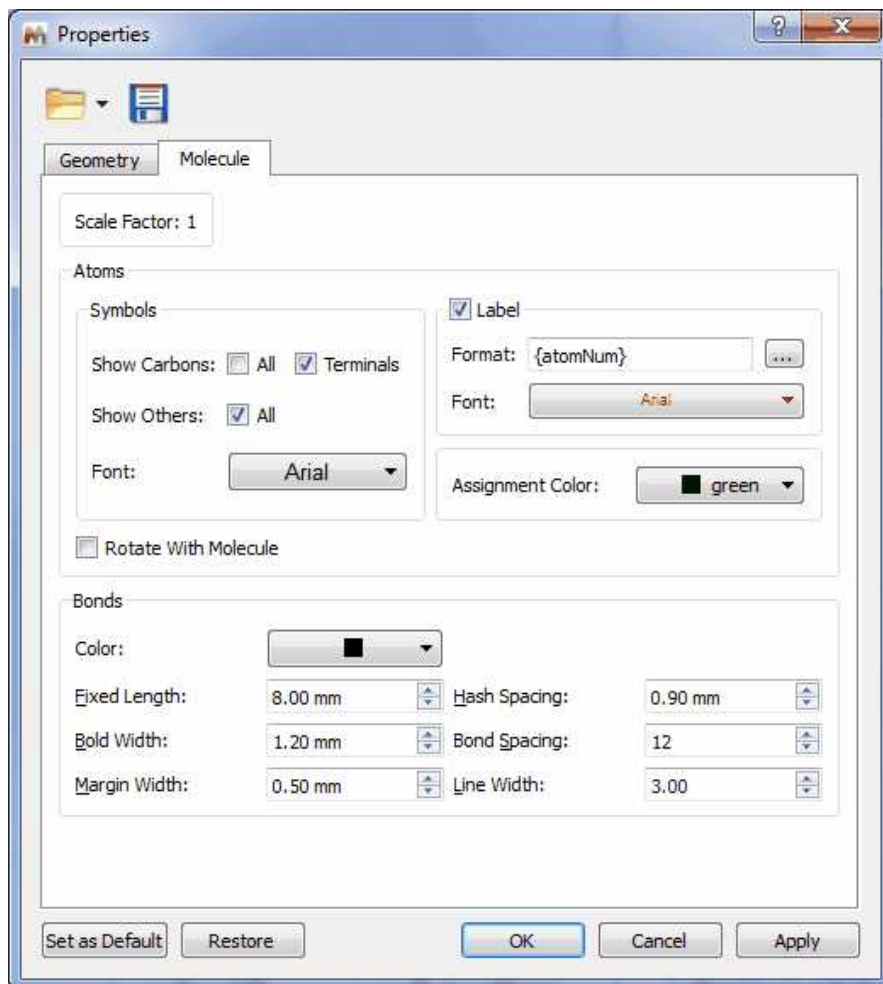

This box can be accessed by double clicking on the molecule, or by right clicking and then scrolling down to 'Properties'.

7.6 Preferences

Following the menu 'Edit/Preferences', you will be able to change the options of the Mnova Interface, plugins, NMR and drawing tools.

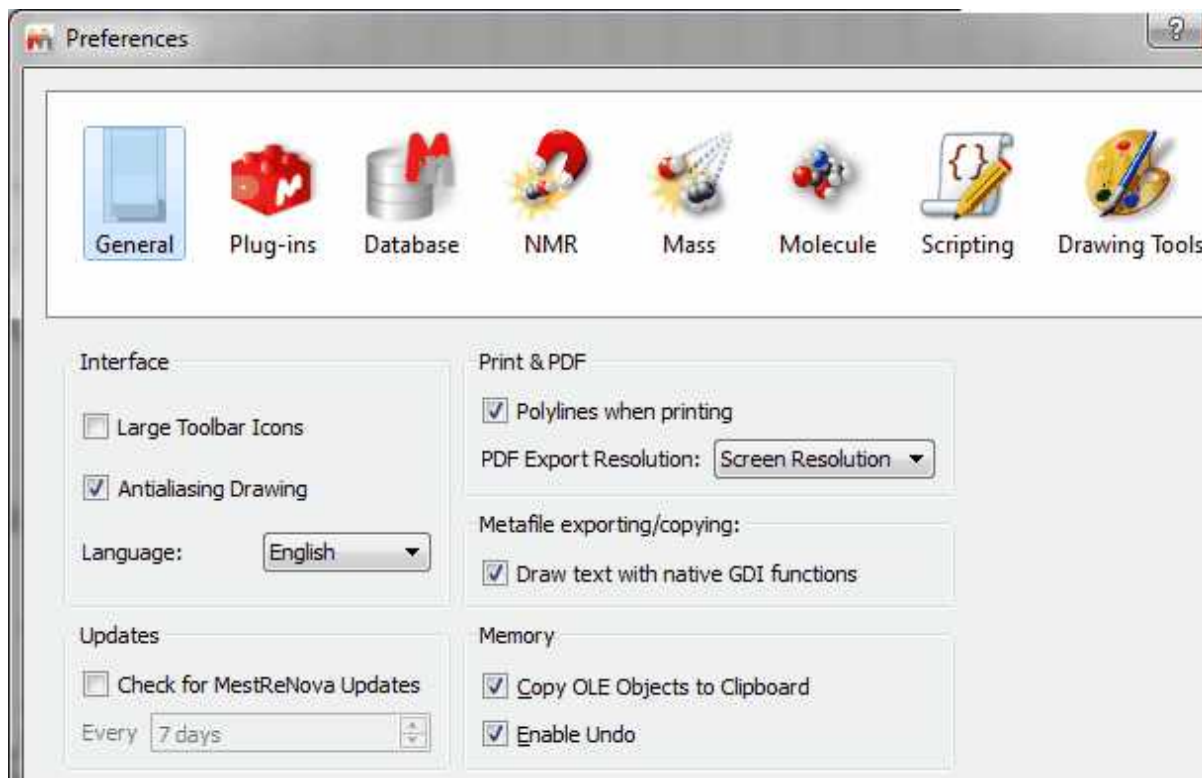

From the General Preferences, you will be able to choose between large or small toolbar icons.

'Antialiasing': This is the technique used to minimize the distortion artifacts known as *aliasing* when representing a high-resolution signal at a lower resolution.

Aliasing is an effect that causes different continuous signals to become indistinguishable when sampled. *Aliasing* also refers to the distortion or artifact that is caused by a signal being sampled at high resolution (on the spectrometer) and then rendered on the PC video-display at lower resolution.

The **'Antialiasing'** is checked by default in Mnova.

Language: Chinese, English, Japanese, Russian and Spanish versions of Mnova are currently available.

Metafile exporting/copying: By default the option is checked and the text will be drawn by the GDI+ engine natively as text. If the option is unchecked then the GDI+ engine will draw the text as paths.

The differences between both options are:

With the native text drawing option, the resulting metafile could be slightly different from what you see in Mnova due to differences on how GDI+ renders text.

With the other option, the text should be shown exactly as Mnova shows, but the text objects in the metafile aren't no more text objects, they are vector graphics objects, so user couldn't edit the text by typing/deleting characters

Print&PDF Exporting: From here you can select the PDF export resolution or the use of polylines when printing.

If you work with huge datasets, in order to avoid **memory** issues, you can uncheck the memory options to be able to copy your spectra to clipboard or to disable the Undo feature.

From the **'Plugins Preferences'** dialog box, you will be able to ignore any plugin, which will be very useful in the case of concurrent (floating) licenses, in order to 'liberate' the license of those plugins

which will not in use.

In any case, please bear in mind that Mnova allow users to only take the plugins they are **using** as opposed to the plugins which are **installed**.

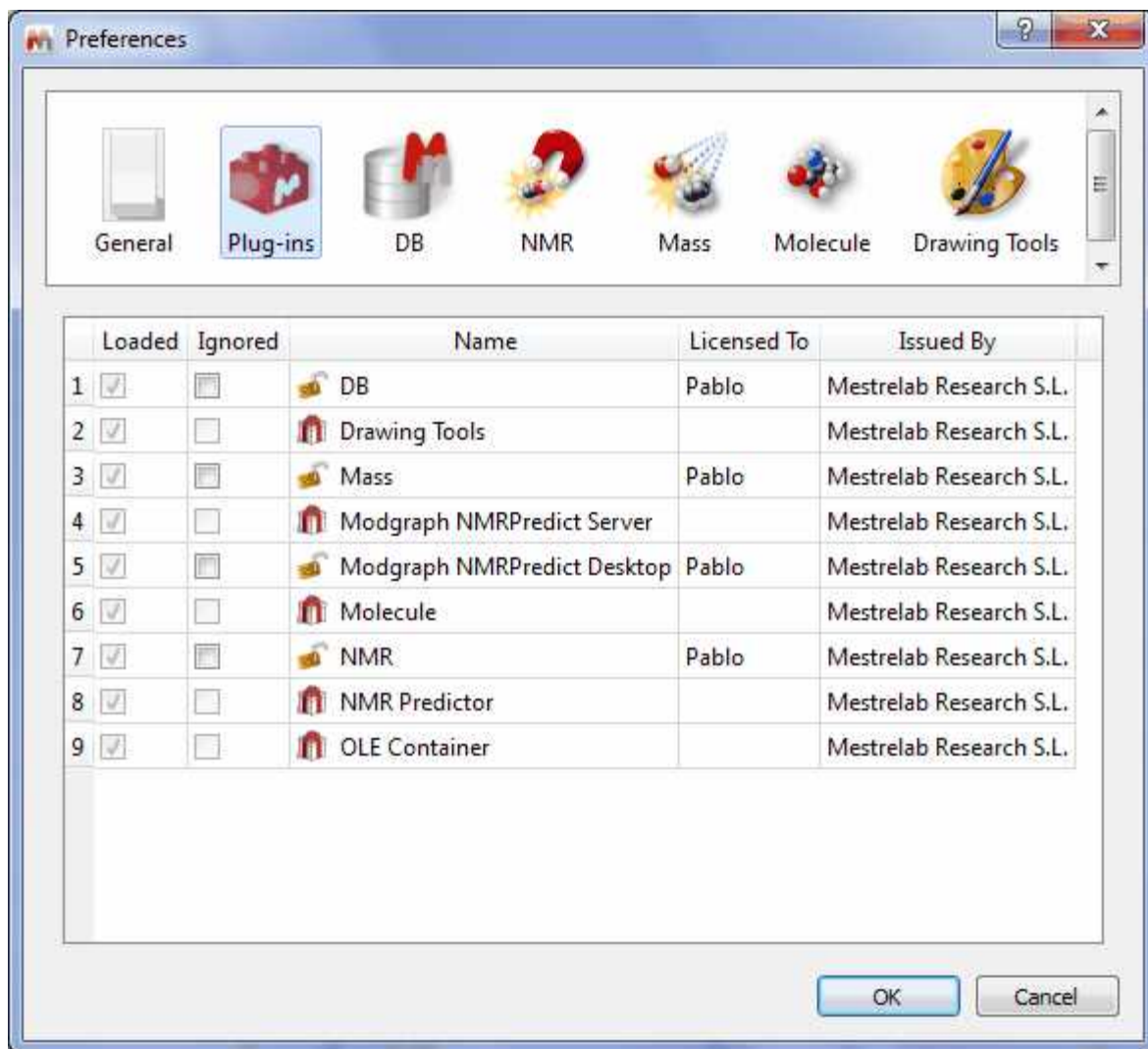

From the '**NMR Preferences**' dialog box, you will be able to select the mode of the '2D palette mapping' (default, absolute and dynamic).

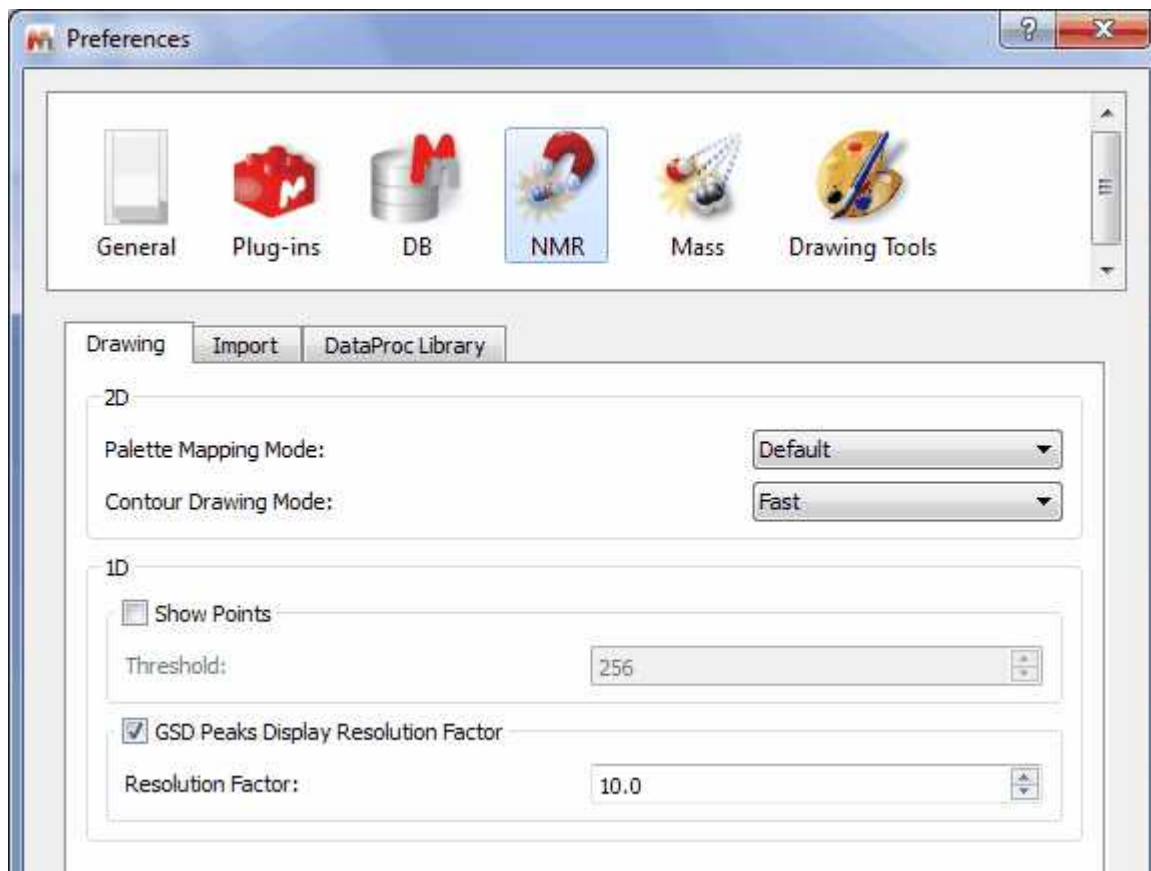

From this dialog box, you will also be able to select threshold of the limit of the number of points showed in the spectral window. For example if your spectral window has less than 128 points (and you have this option checked), you will see the points (as crosses) drawn on it; as you can see in the picture below. If the spectral window has more than 128 points, you will see the spectrum as usual.

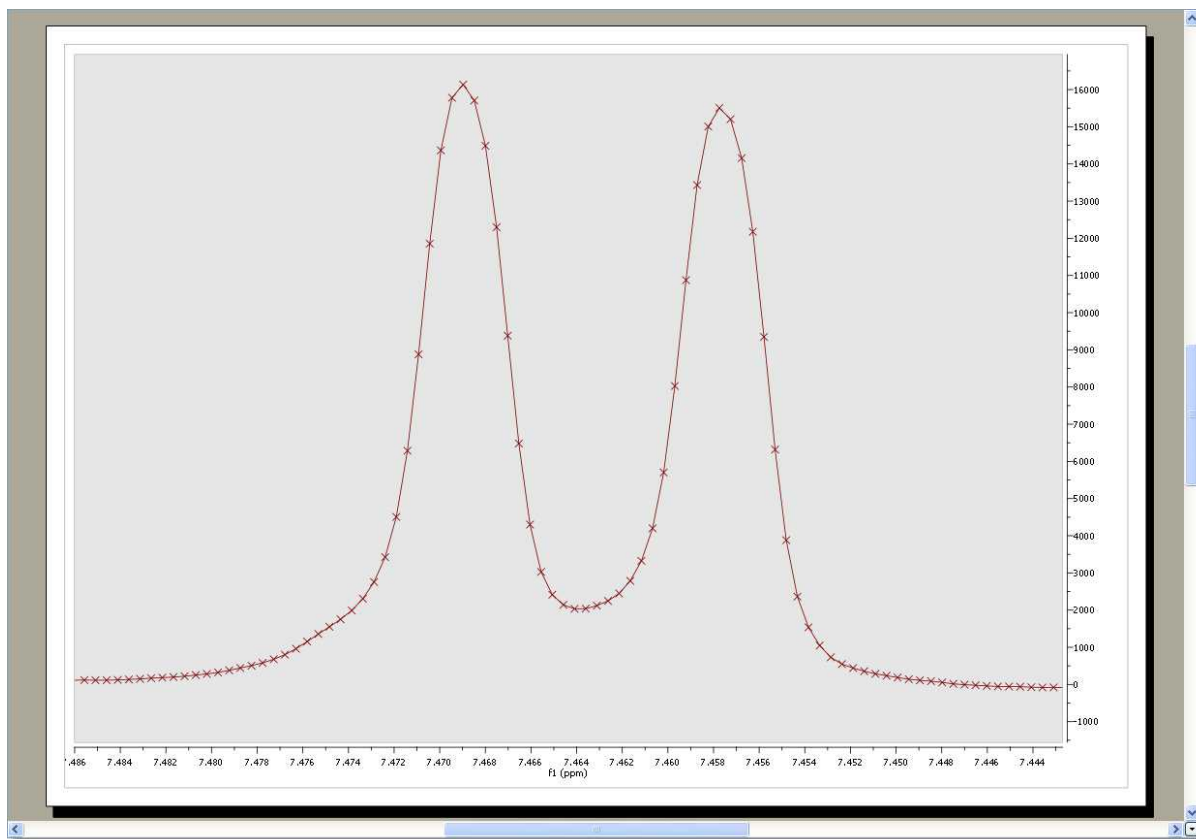

From this Preferences menu you can also select the GSD display resolution factor.

The GSD peaks extend over all the spectra but when drawing we are cutting the display at some point to speed up the drawing. By default Mnova uses the peak width by a factor to "cut" the peak display. This behavior is the default one but is optional. The user will be able to change it in the preferences (NMR tab) just by checking "GSD Peaks Display Resolution Factor". And if it's checked it will be possible to adjust the factor (10 by default) to be multiplied by the width.

From this menu, but selecting the Import label, the user will be able to select the option to import the Apodization, Zero Filling, Linear Prediction, Baseline correction options from the spectrometer and also the default phase correction method (Imported or Automatic):

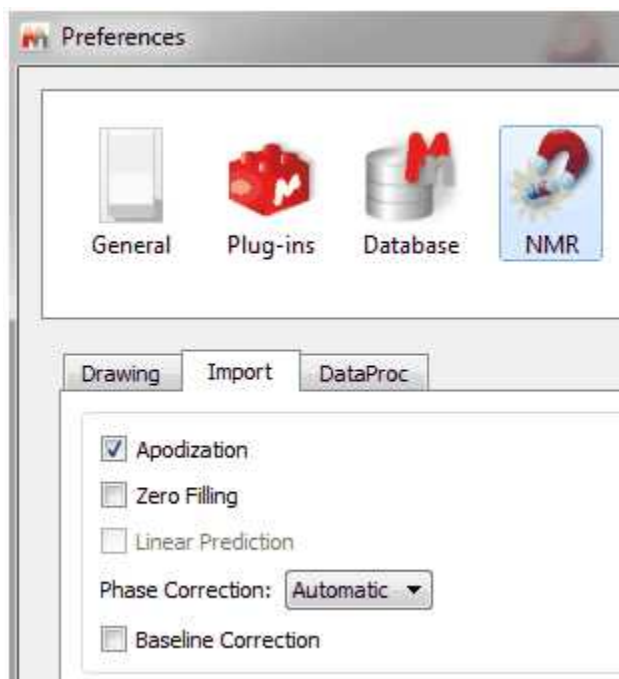

From the **'Mass Preferences'**, the user will be allowed to select the saving options (item only or item +dataset). When the option 'Synchronized chromatogram's Time Scale' is selected, it will be possible to zoom, pan and cut to all showing chromatograms. You will find also an option to fit to height after zoom (selected by default). When this option is checked, a fit to height is applied after making a horizontal zoom in a mass spectrum or a chromatogram. In case of the other zoom modes (vertical or in both dimensions), a fit to height is never applied.

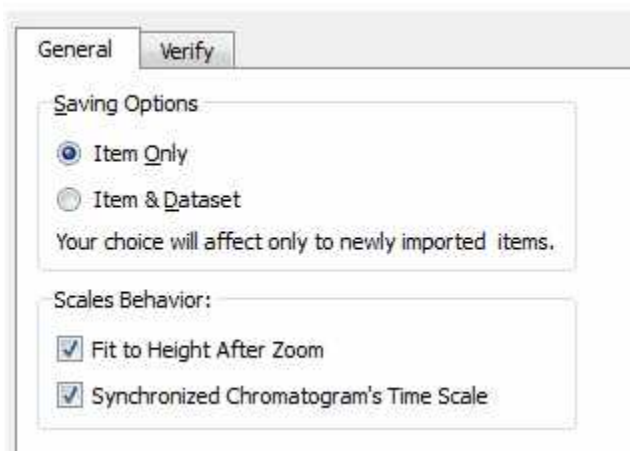

From the **'Molecule Preferences'**, you will be able to save the numbering when you export the molecule to a .mol file (via File/Save as) or 'import molecule styles':

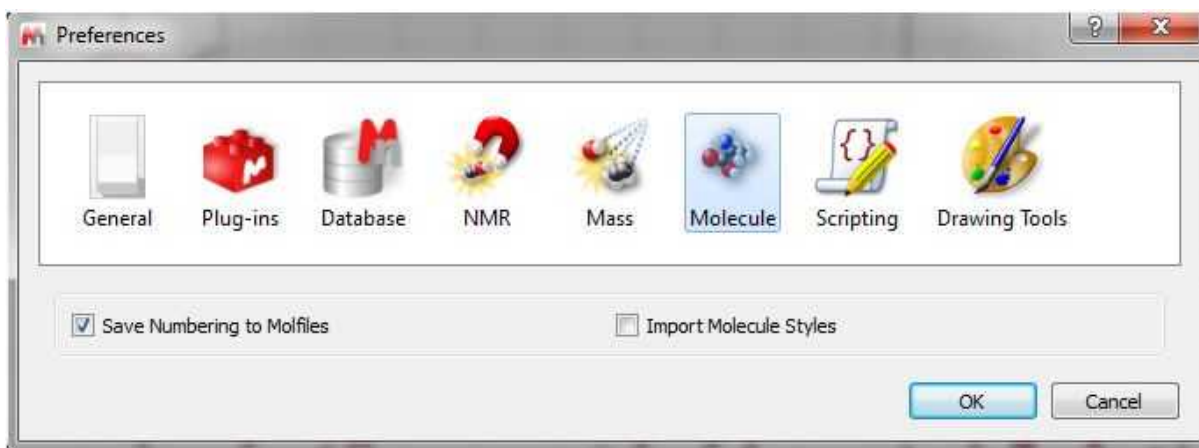

From the '**Scripting Preferences**', you will be able to select the scripting folders and also to create events to run script events by default:

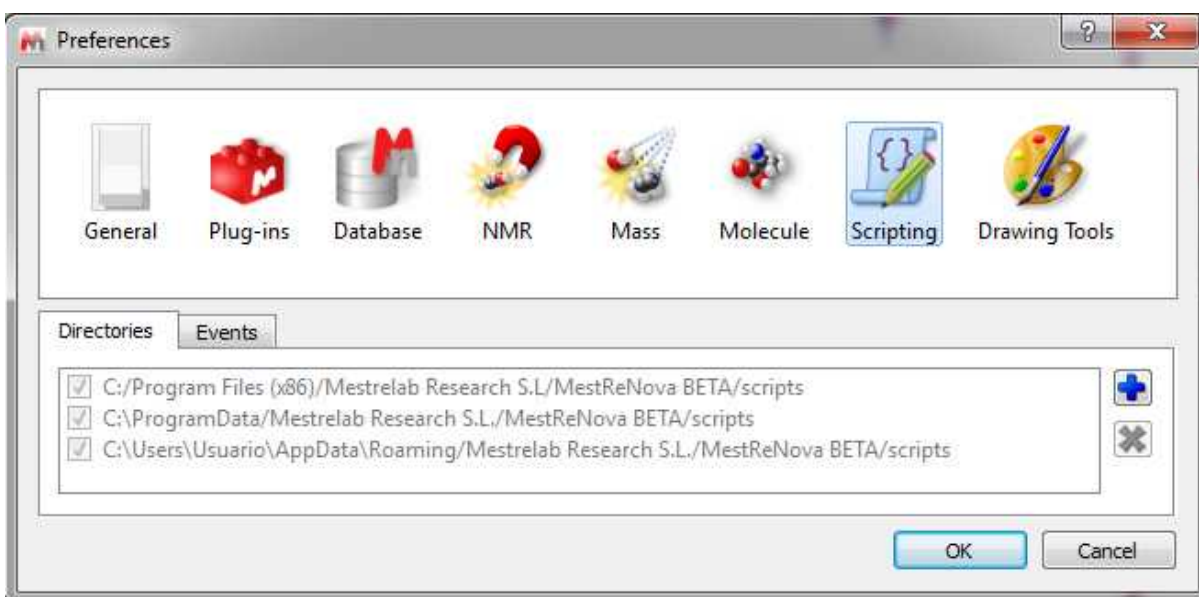

From the '**Drawing Tools Preferences**', you will be able to select the exporting 'Resolution' and 'Quality' of the graphics and also the resolution of the image copying:

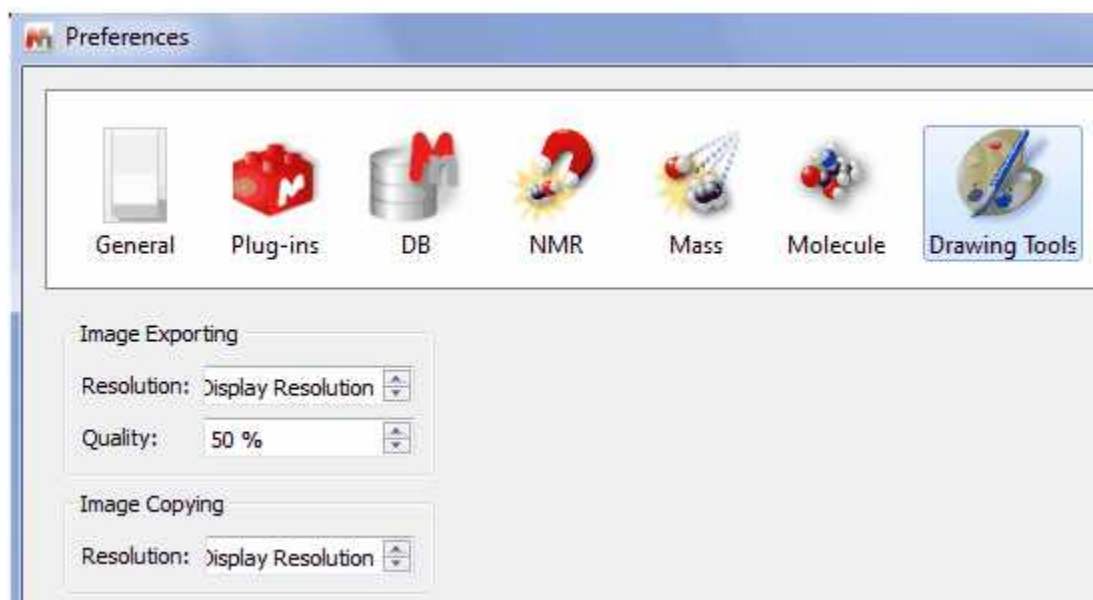

7.7 Contextual Menus

Contextual Menus

Mnova incorporates very useful contextual menus to make it easier to perform some common tasks. The contents of the contextual menu will depend on the window area clicked. For example if you right click (or Ctrl+Click in Mac) on a 2D spectral window, you will obtain the following contextual menu:

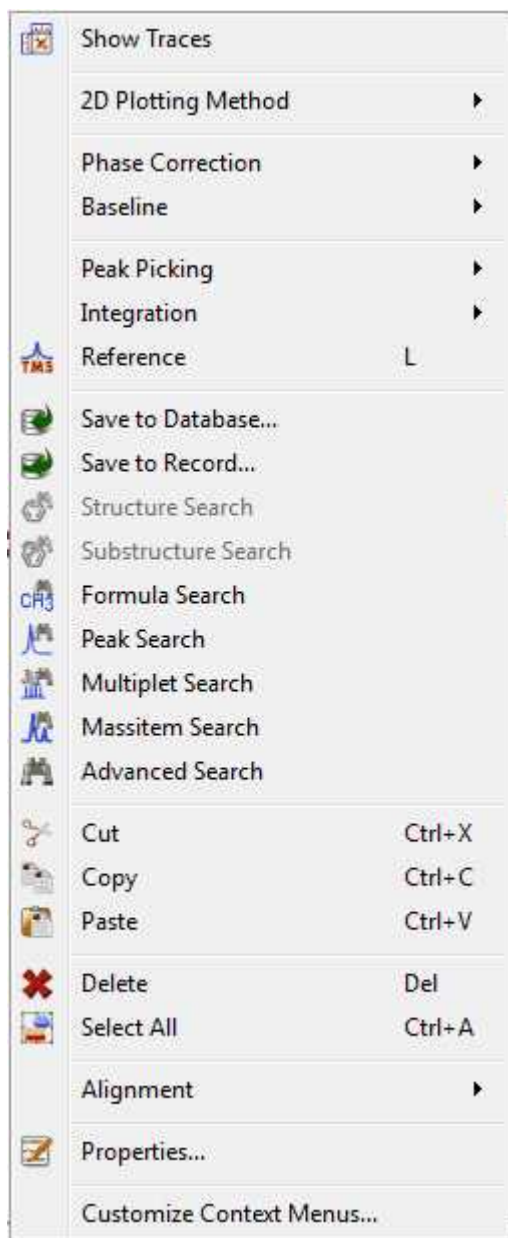

If you right click on a multiplet box, you will obtain:



On a molecule:



You will also find useful contextual menus on 1D spectral windows, page navigator, integral curves, traces, axis etc.

As you will notice it is possible to customize the contextual menus, just by selecting 'Customize Context Menus'. This will display the 'Customize Context Menus' dialog box which will allow you to customize the selected 'Context Menu' (highlighted in red in the picture below) by just using the arrow icons to add, remove or sort the desired features.

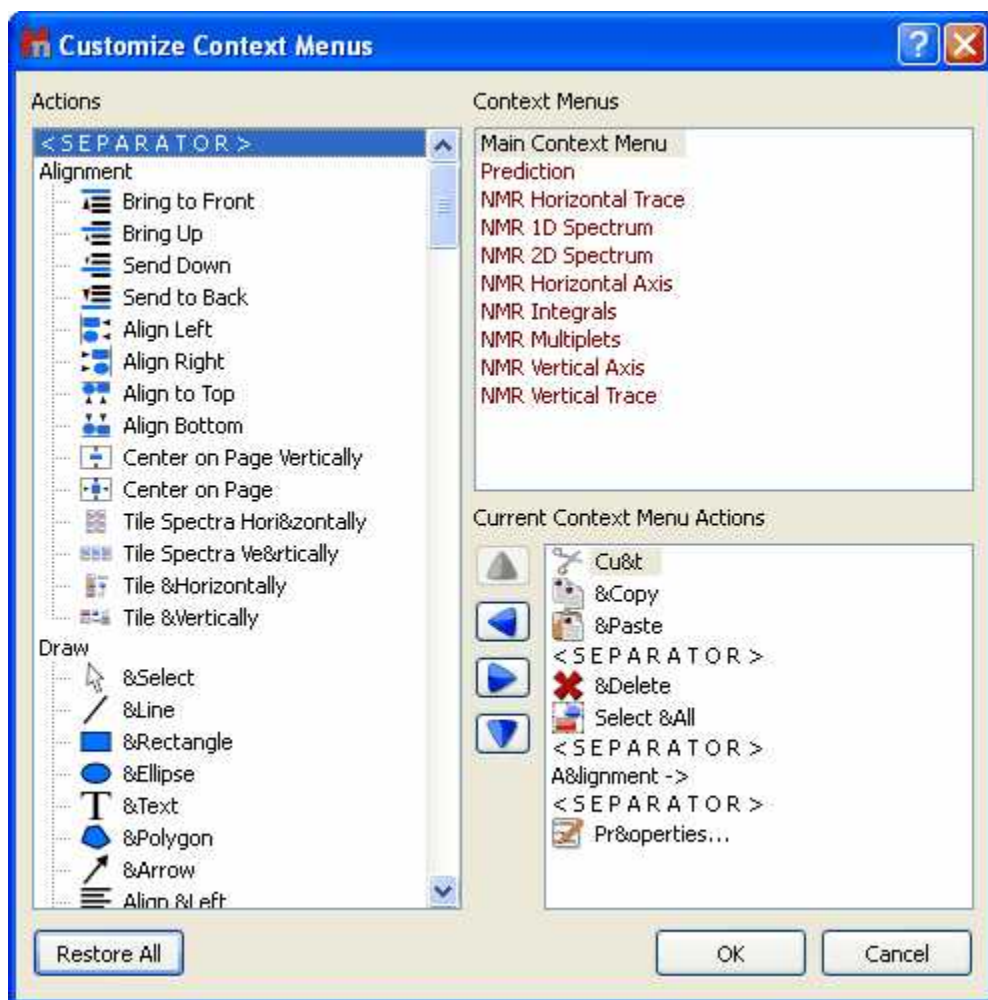

Let's see how to add for example the 'Report Multiplets' tool to the 'NMR 1D Spectrum' Context Menu:

1st: Select the 'NMR 1D Spectrum' context menu:

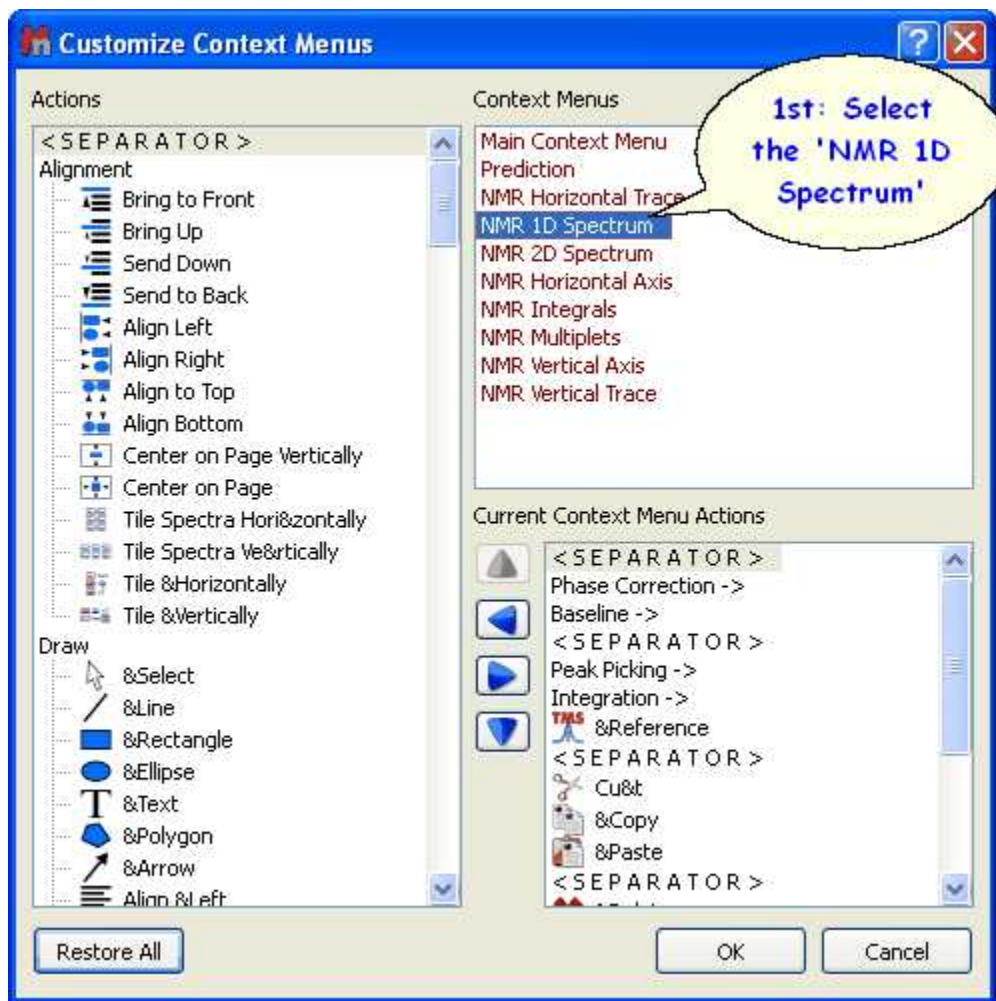

2nd: Navigate to the 'Report Multiplets' feature in the 'Actions' menu (at the left side of the window):



3rd: Click on the 'Right Arrow' button  to add the 'Report Multiplets' feature to the 'NMR 1D Spectrum' context menu:

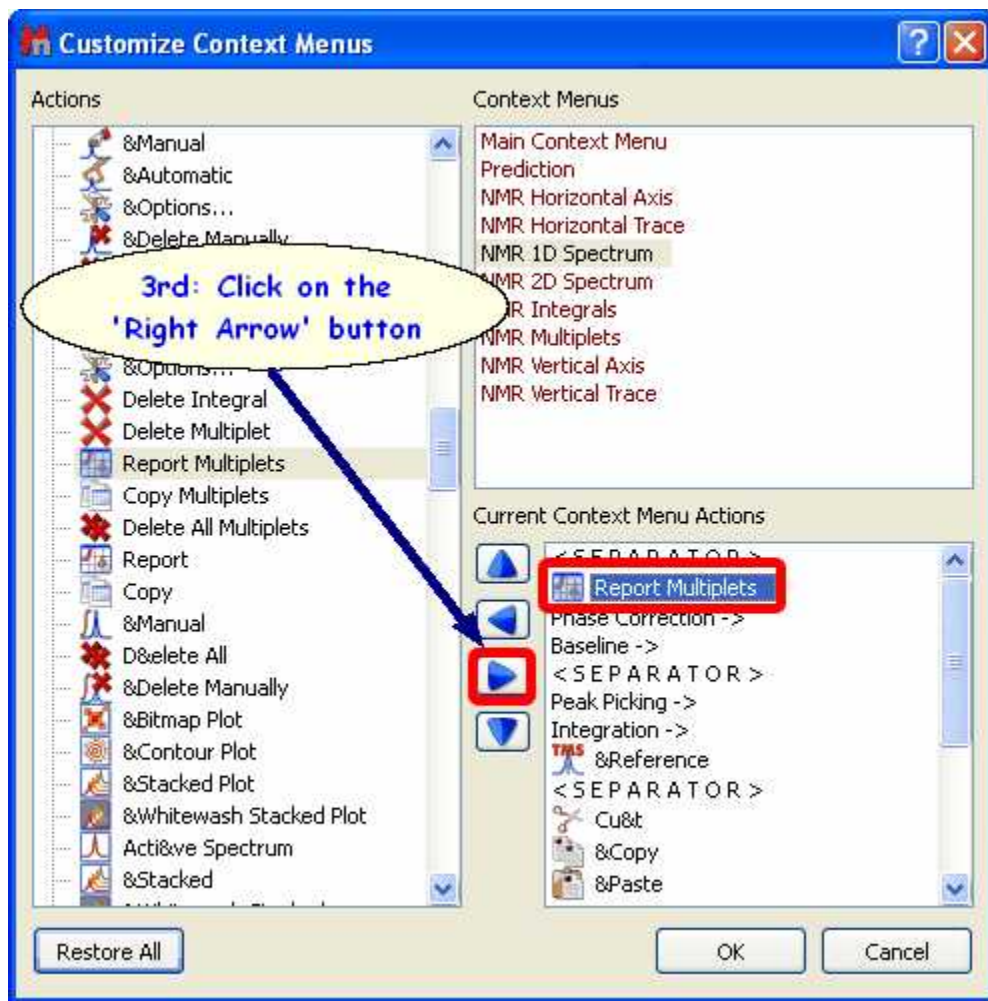

4rd: Finally, click on OK and you will be able to see the 'Report Multiplets' feature in the 'NMR 1D Spectrum' context menu:



Please bear in mind that you will be able to remove the undesired features, just by clicking on the 'Left Arrow' button  of the 'Customize Context Menu' dialog box. You can also sort the features on the context menu just by using the up and down arrow buttons.

It is possible to save (or export) the customization of the Contextual Menus just by following the menu: File/Save as/MestReNova Customization (*.mncs):

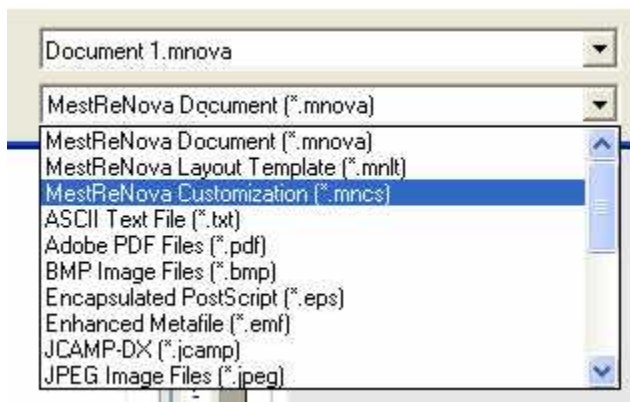





Then, you will be able to open any Customization file just by following the menu 'File/Open' (exactly in the same way as this would be applied to a spectrum).

7.8 Toolbars Customization

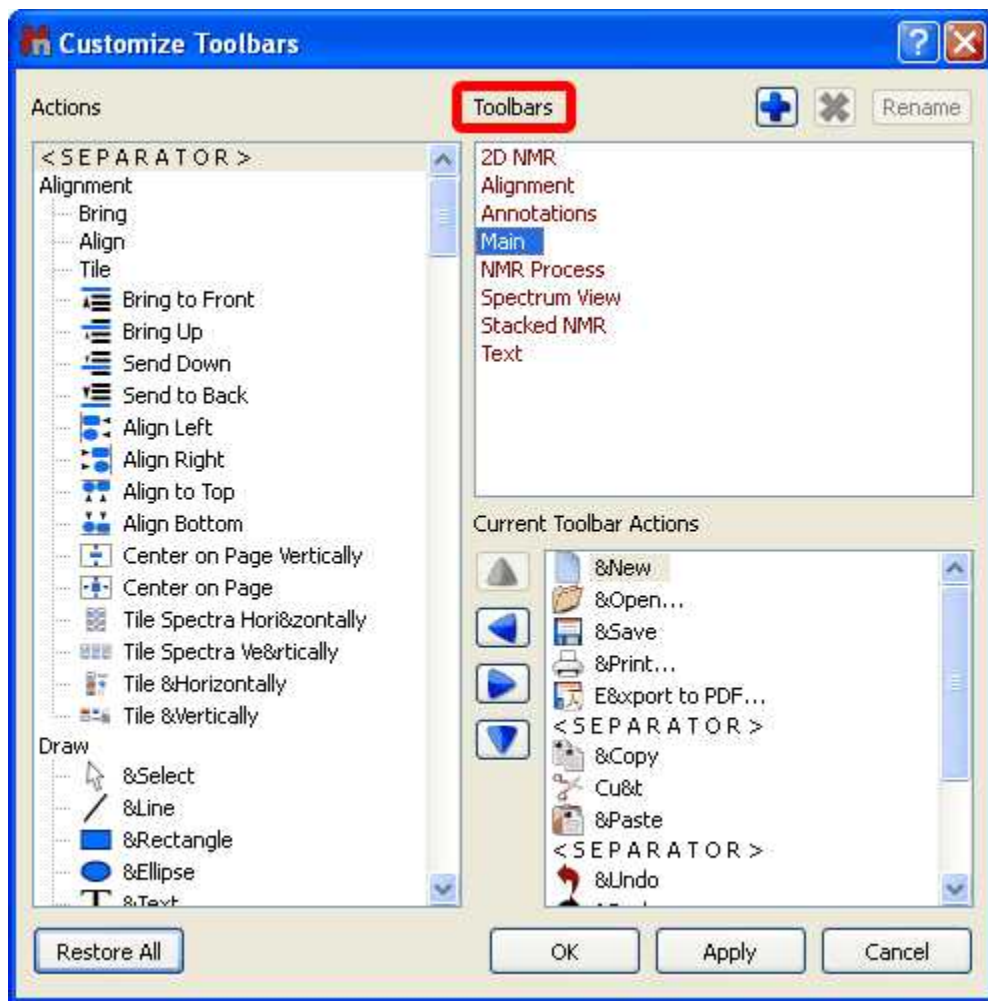
Toolbars Customization

Mnova incorporates the capability to allow the user to customize the toolbar just by following the menu: 'View/Toolbars/Customize Toolbars' (or by right clicking on the toolbar and selecting 'Customize Toolbars'). This will display the 'Customize Toolbars' dialog box:



From here, you will be able to customize the selected 'Toolbar' (highlighted in red in the picture above) by just using the arrow icons to add, remove or sort the desired features. Of course it is possible to add , remove  or rename  any created toolbar just by clicking on the applicable buttons.

Let's see how to add the 'Report Multiplets' feature to the 'NMR Process' toolbar:

1st: Select the 'NMR Process' toolbar from the 'Toolbars list:

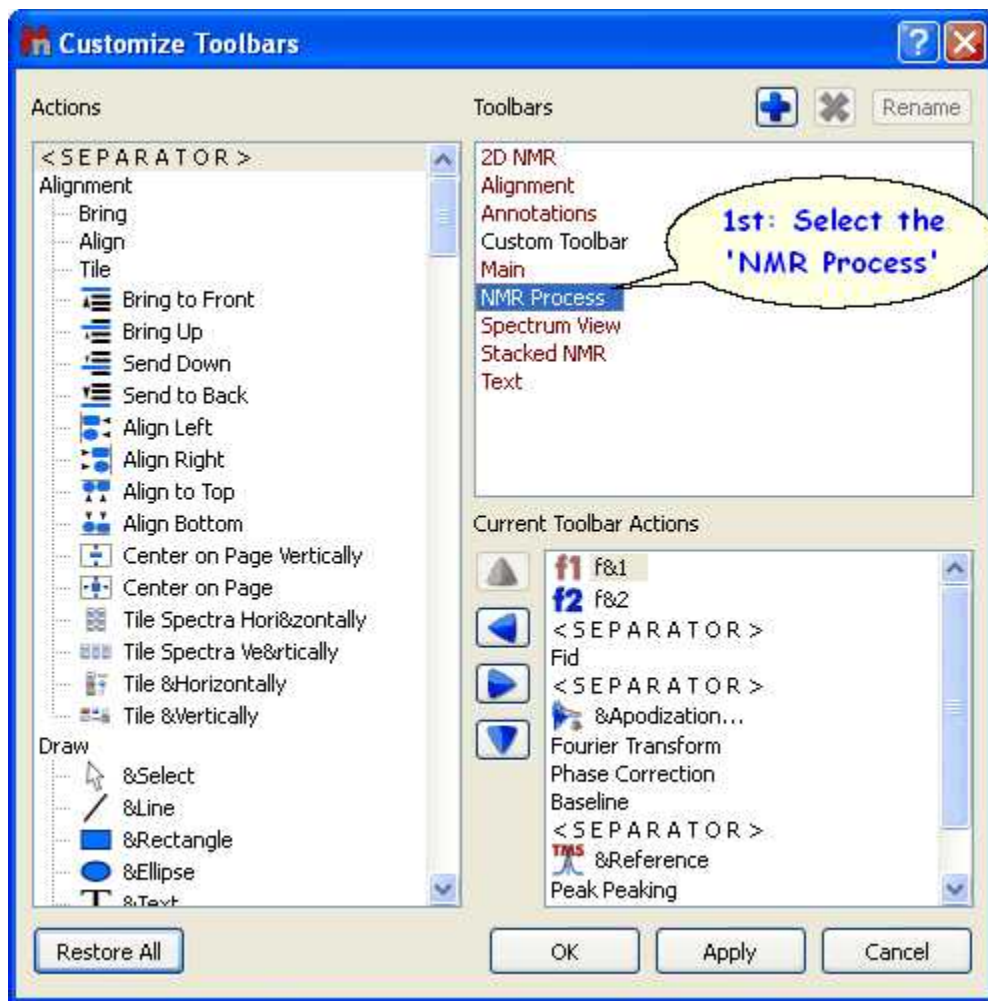

2nd: Navigate to the 'Report Multiplets' feature in the 'Actions' menu (at the left side of the window):

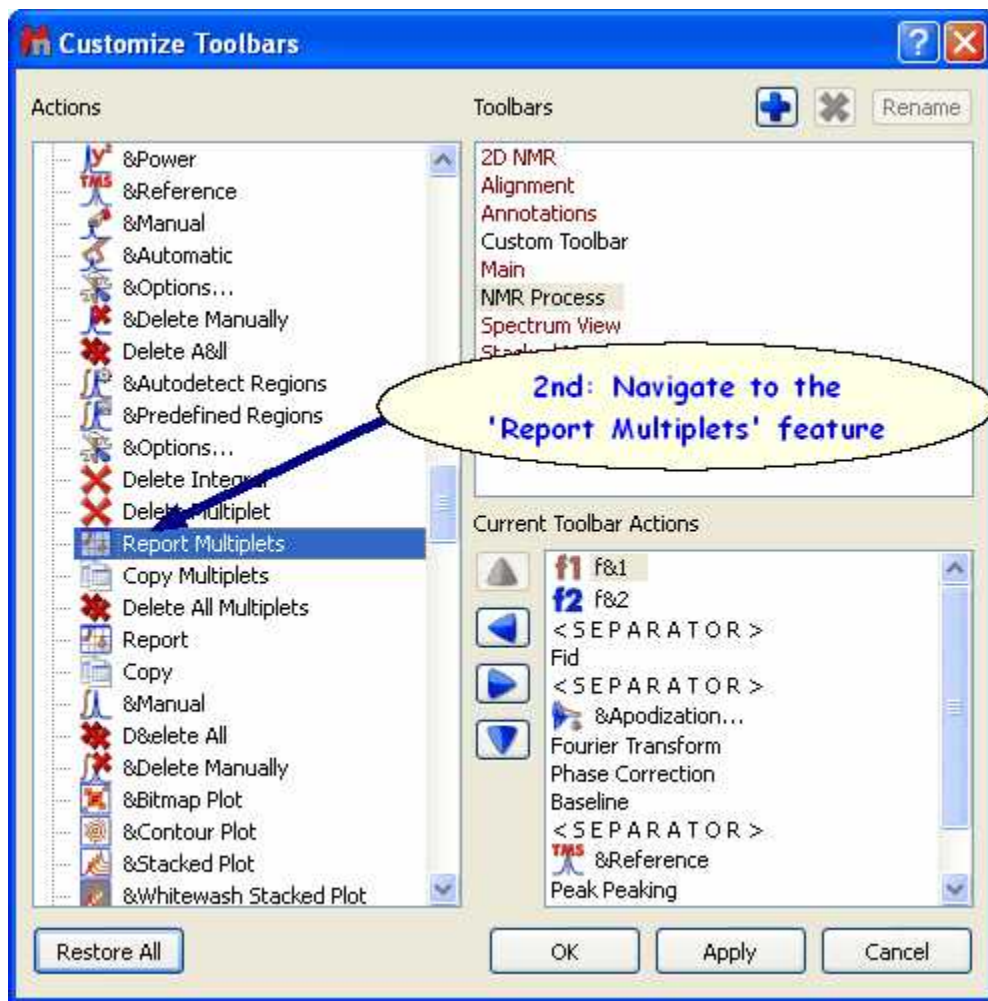

3rd: Click on the 'Right Arrow' button  to add the 'Report Multiplets' feature to the 'NMR 1D Spectrum' toolbar:



4rd: Finally, click on OK and you will be able to see the 'Report Multiplets' icon in the 'NMR Process' toolbar:



Please bear in mind that you will be able to remove the undesired features from the toolbar, just by clicking on the 'Left Arrow' button  of the 'Customize Toolbars' dialog box. You can also sort the features on the toolbar just by using the up and down arrow buttons.

You can also also add the verification feature (and options) to your toolbars (if you have the applicable license activated):

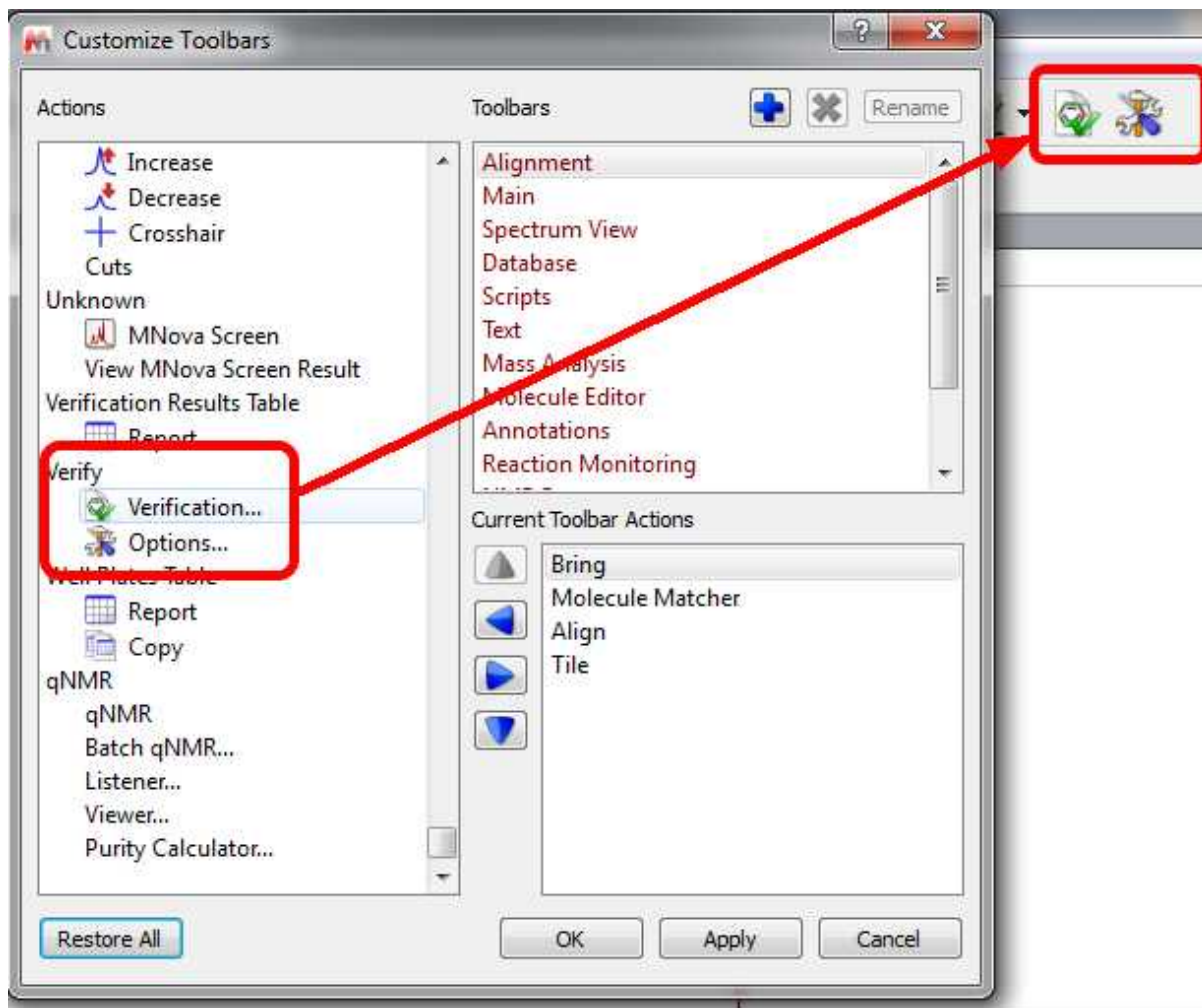

It is possible to save (or export) the customization of the Toolbars just by following the menu: File/Save as/MestReNova Customization (*.mncs):

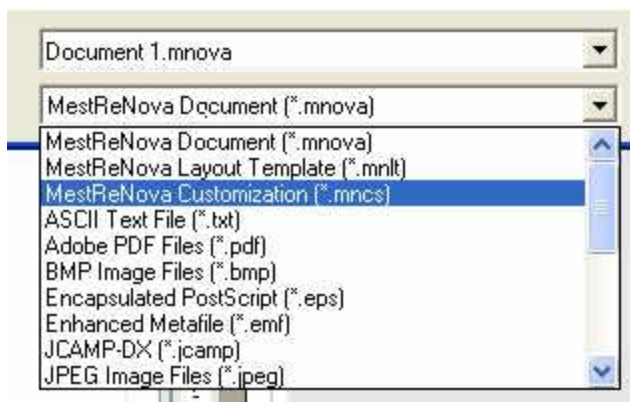

Then, you will be able to open any Customization file just by following the menu 'File/Open' (exactly in the same way as this would be applied to a spectrum).

You can also add any created script on the toolbar, but please bear in mind that the script file will need to have the same name that the function which you want to call. For example, if the name of the

function is 'example', then the name of the script will be 'example.qs'. Then, you will need to add this line with the applicable 'Name in Menu' at the beginning of the script:

```
//<GUI menuname="Name In Menu" tooltip="My ToolTip" icon="/path/to/icon"/>
```

Finally, store the script in the Mnova scripts folder and restart Mnova to be able to see the script in the scroll down menu of the 'Run Script' icon and in the list of icons in the customize toolbar dialog box.

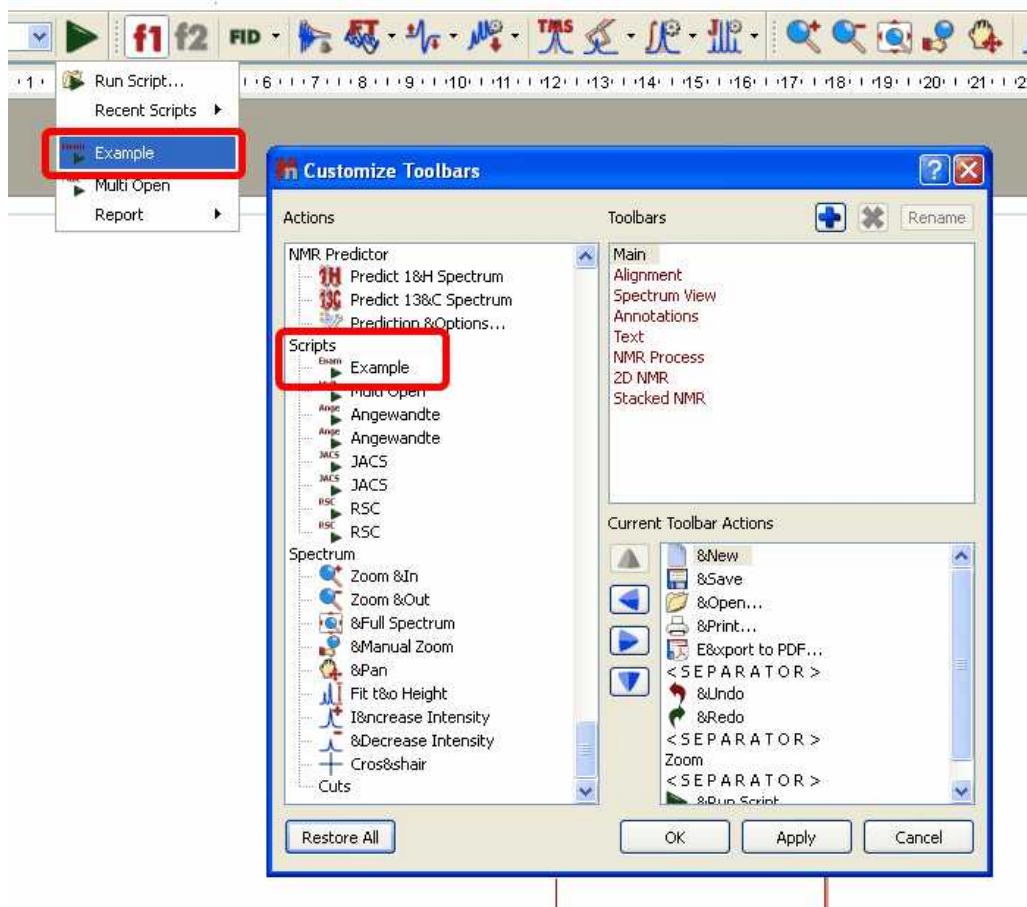

7.9 Localization

Localization:

English, Japanese, Russian and Spanish versions of Mnova are currently available. The user will be able to select the desired idiom by following the menu 'Edit/Options/Language':

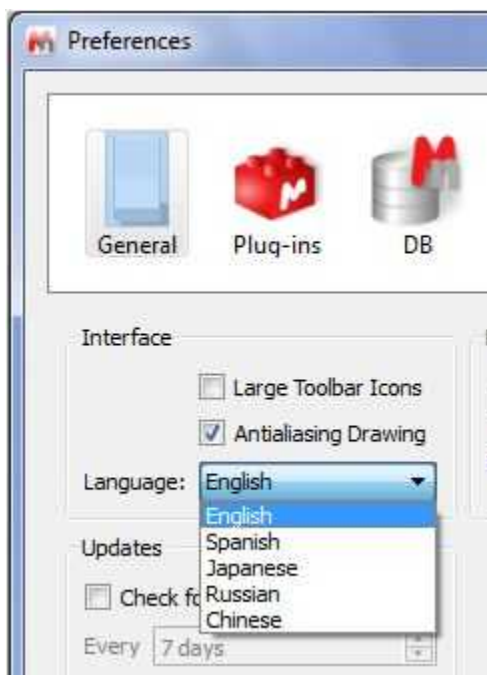

Once, the user had selected the desired language, a dialog box will be displayed to inform that it will be needed to restart Mnova in order to obtain the change of the language .

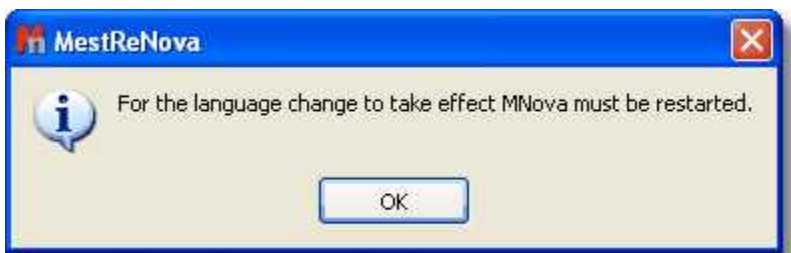

The Japanese version is shown in the picture below:

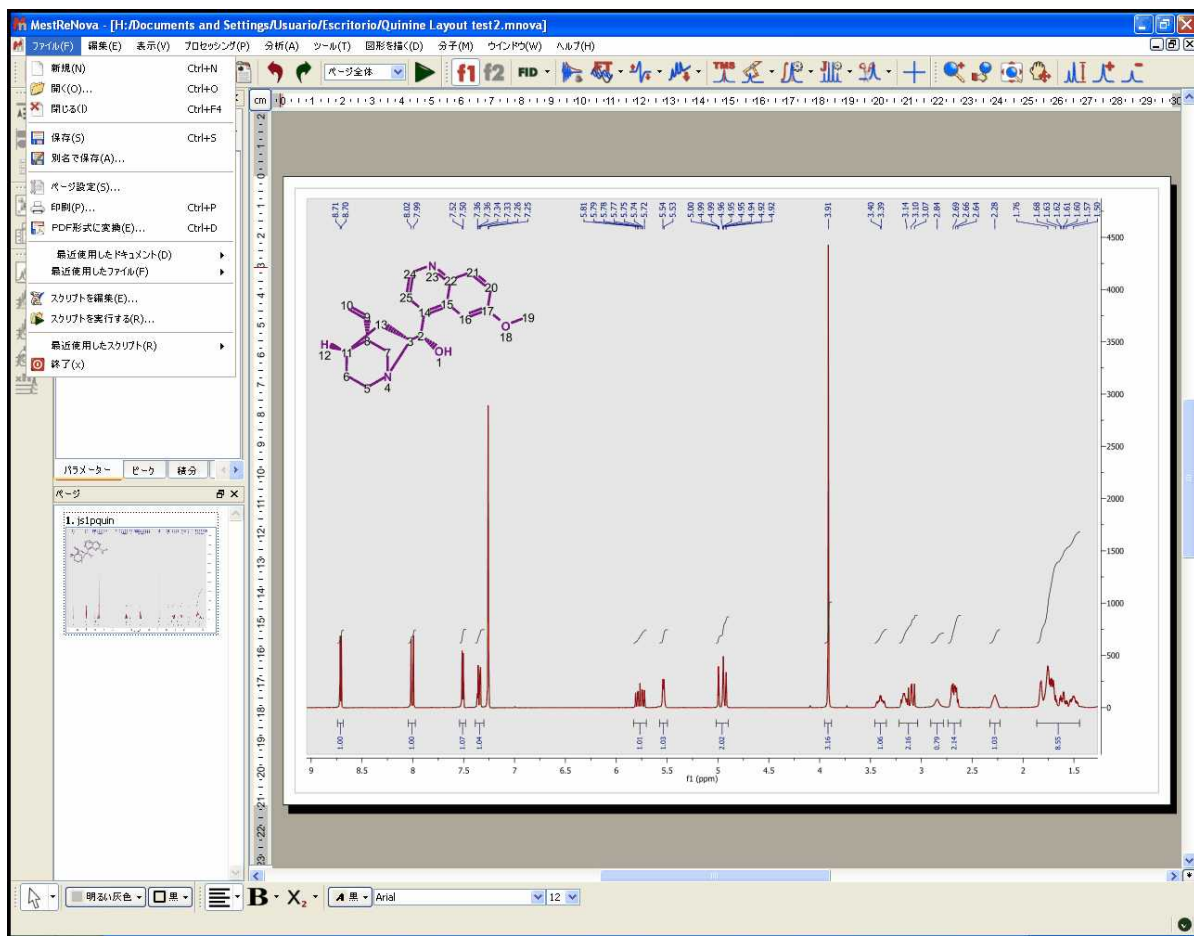

We plan to update once per year the different translations of the software, so you may find the newest feature menus without translating (in english).

7.10 Layout Templates

You will find a sample Layout Template in the installation folder of Mnova (under the examples/datasets folder)

It is now possible within Mnova to create '**Layout Templates**' for your NMR spectra. Please note that this feature is not completely finished in this version and that it will be greatly enhanced for the oncoming release versions.

This feature includes the capability to create templates with the location of the spectrum, molecular structure, images, tables and multiplet reports. It is very easy to create a template with Mnova, just open a document and select the desired location and properties for the different objects present in it. The picture below shows a ^1H -NMR spectrum, with the applicable molecular structure, multiplet report, images and the Parameters table:

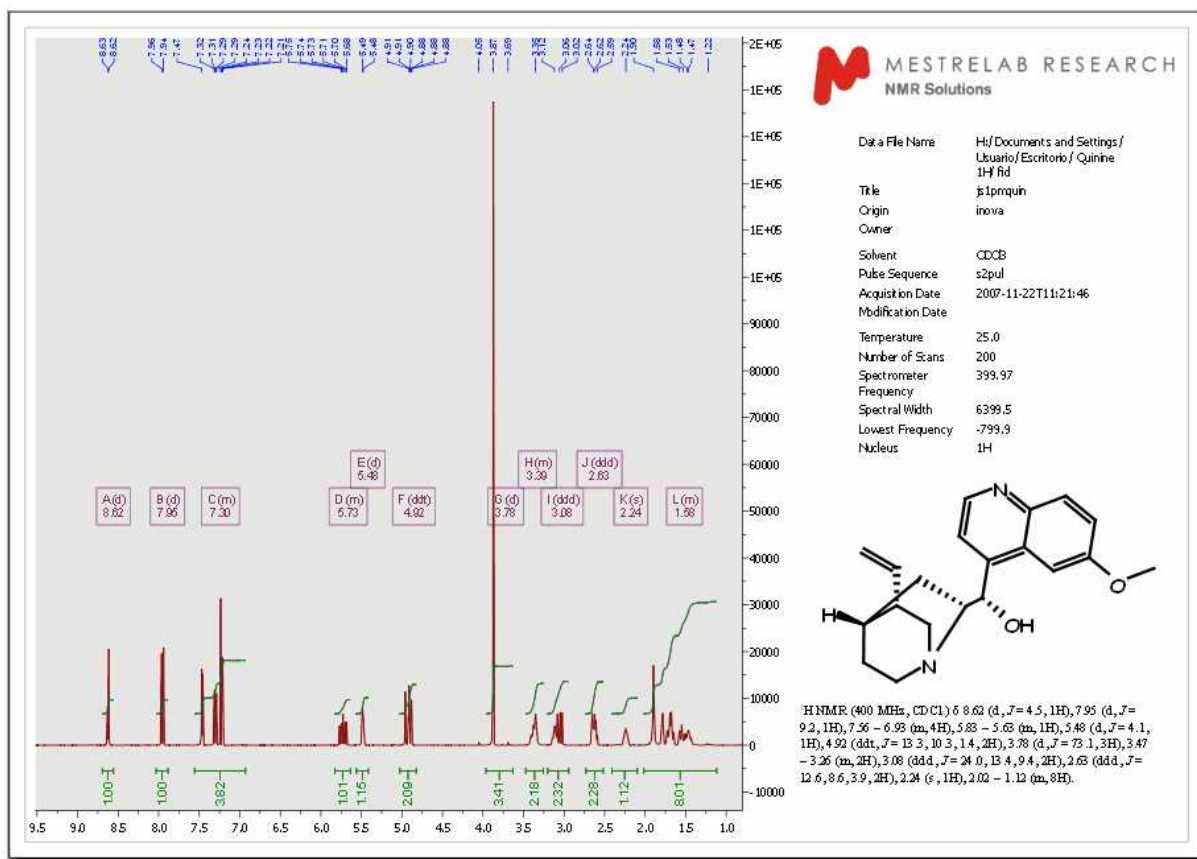

To save the created layout as a template, just follow the menu **'View/Layout Templates/Create Template Document'** and select the location of the new template.

Once saved, a template can be easily opened by double clicking on the .mnova file. Please note that drag and drop also works in this instance.



ATTENTION

The layout template will keep all the properties of the objects (draws, annotations, spectra and molecules), the processing (optional) and the analysis features used in the original spectrum ('peak picking', 'integrals', 'multiplets' or 'cuttings').

The picture below shows the layout created previously:



If the user opens a different 1D-NMR spectrum over this layout, it will be obtained in the applicable location, with the corresponding processing and analysis features (multiplet analysis in this case) and also with the applicable object properties, including all the relevant tables and reports:

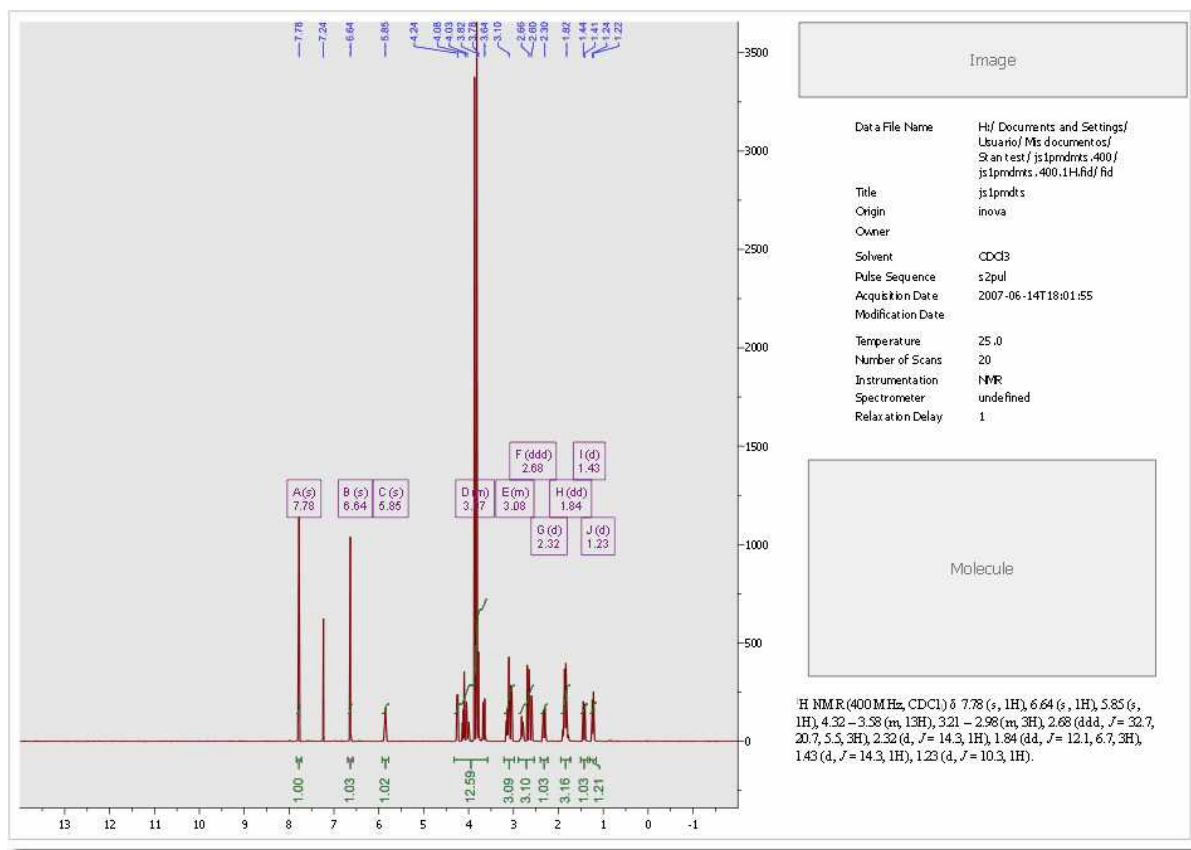

In the same way, when the user opens or pastes a molecule and an image, they will also be automatically displayed in the corresponding location (with the original properties).

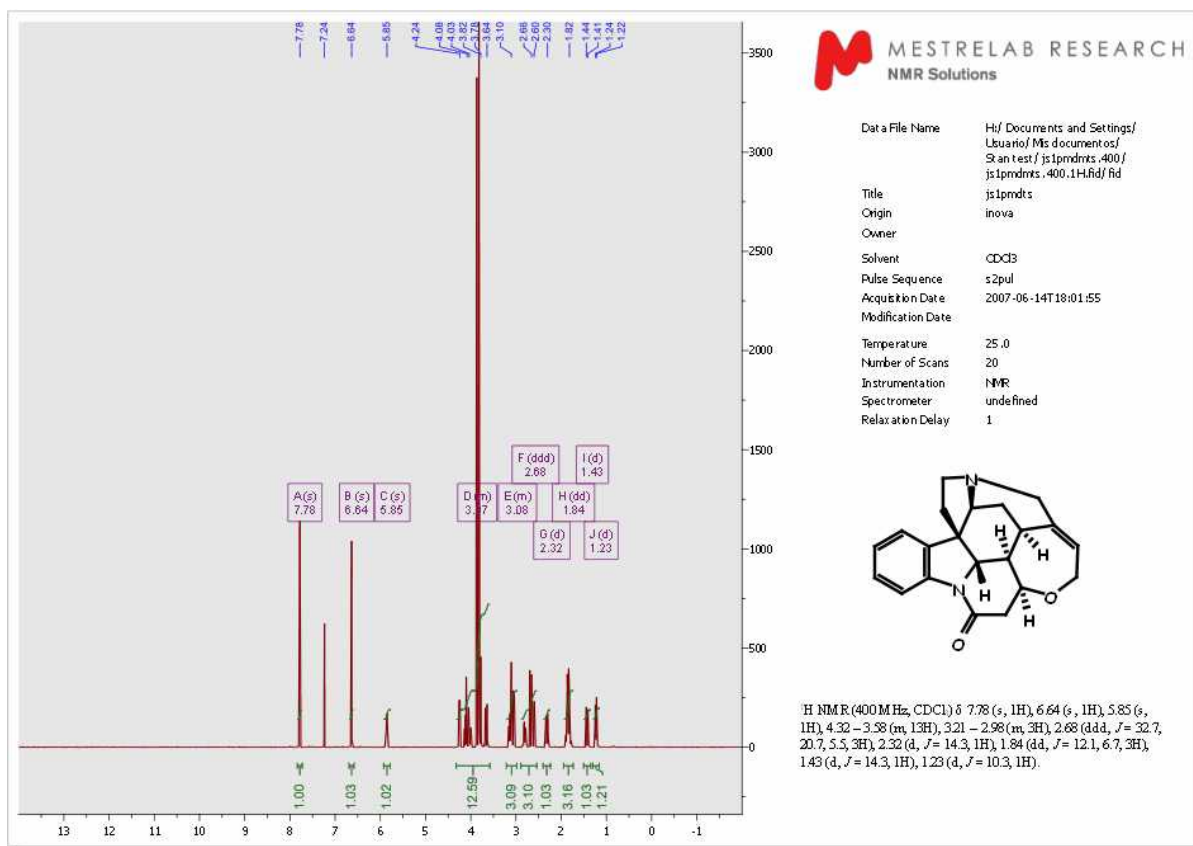

Also note that our concept is designed to be extended to reports with more than one page, to allow for the placing of several spectra on the report (in this case ¹H, ¹³C and HSQC):

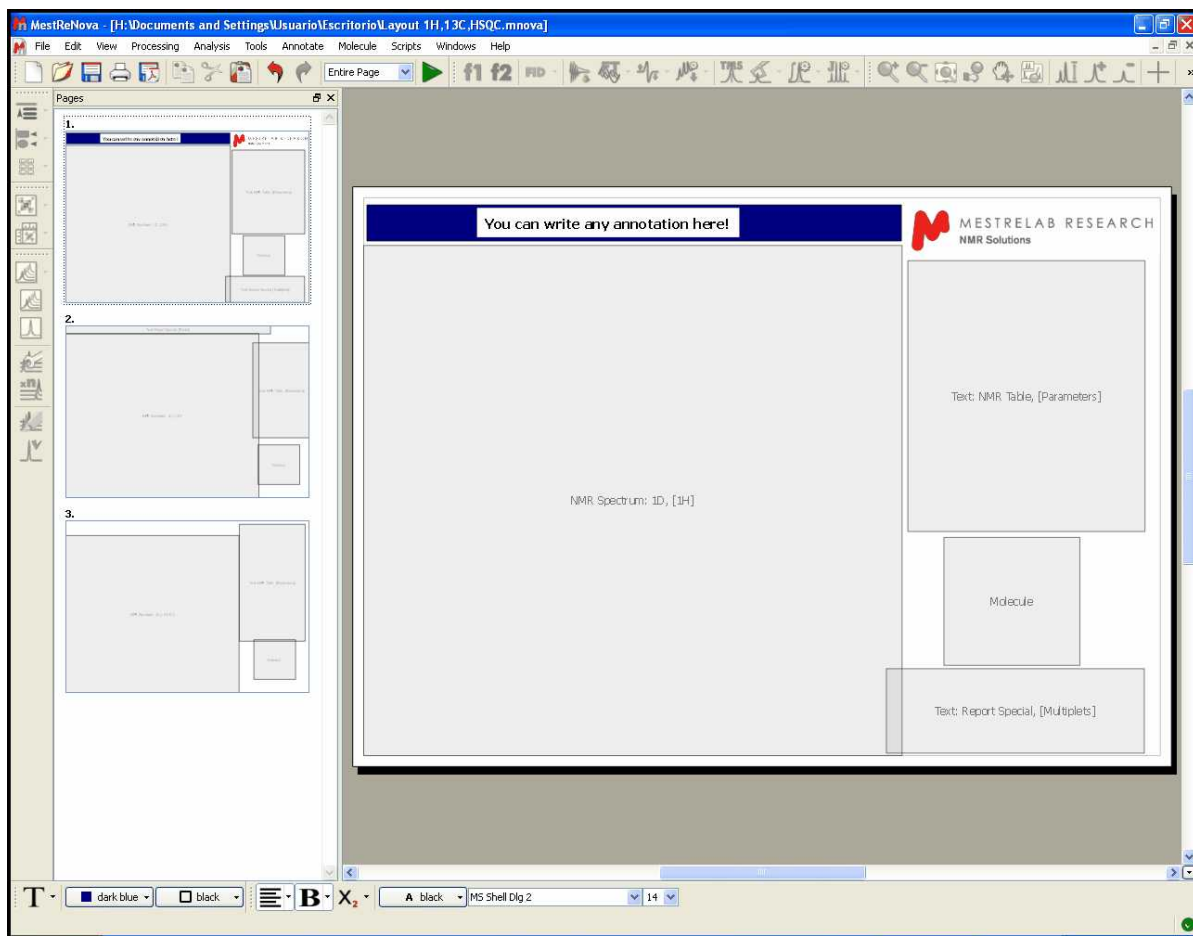

It is also possible to modify any layout template. For example in the template above we have added an annotation and a logo and then clicked in the 'Save' button. If you open again the template you will have by default the annotation and the logo on your screen. You can also double click on any item to change any property and then save the changes.

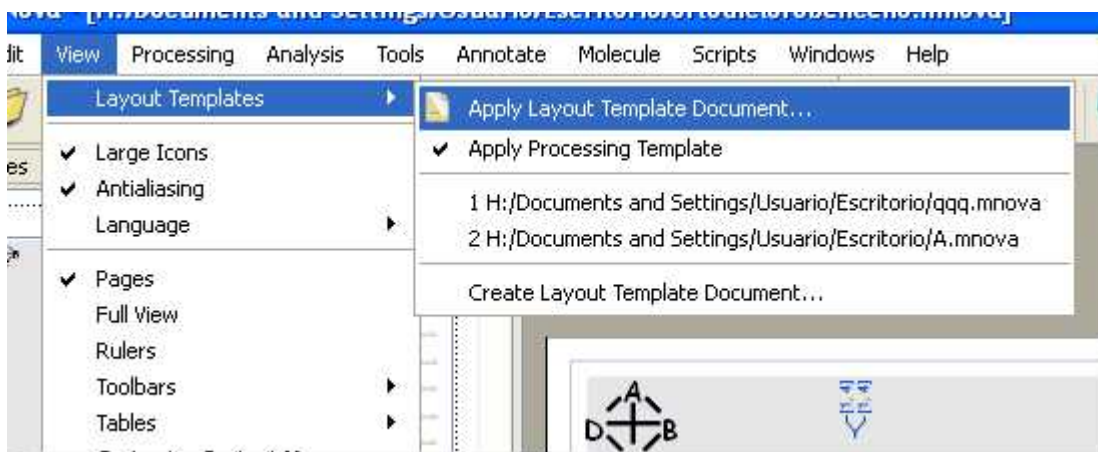

It is also possible to apply a layout template to any opened spectrum, just by following the menu 'View /Layout Templates/Apply Template Document':





If you check the '**Apply Processing Template**' option, the layout template will keep also the processing used in the original spectrum. If this option is not selected, the layout template will only keep the properties.

7.11 How to measure coupling constants? The Crosshair Tool

The Crosshair:  These two orthogonal lines forming a crosshair are available on the 'View' menu (or by pressing the <c> key) for reporting positional information, and for help in visualizing peak alignments. This tool can also be found on the 'Zoom' toolbar 

How to measure coupling constants?

The crosshair includes information about the chemical shift and the intensity of the peak (as you can see in the picture below) and also allows the user to measure distance between peaks (or **coupling constants**) by clicking on the left mouse button and dragging to the desired peak. This will open an 'Info View' dialog box, where the user will be able to change the units distance is expressed in (Hz, ppm or points). This dialog box will also display the distance between the desired peaks, as well as the intensity ratio. The info View window also contains information about the Spectrum Resolution.

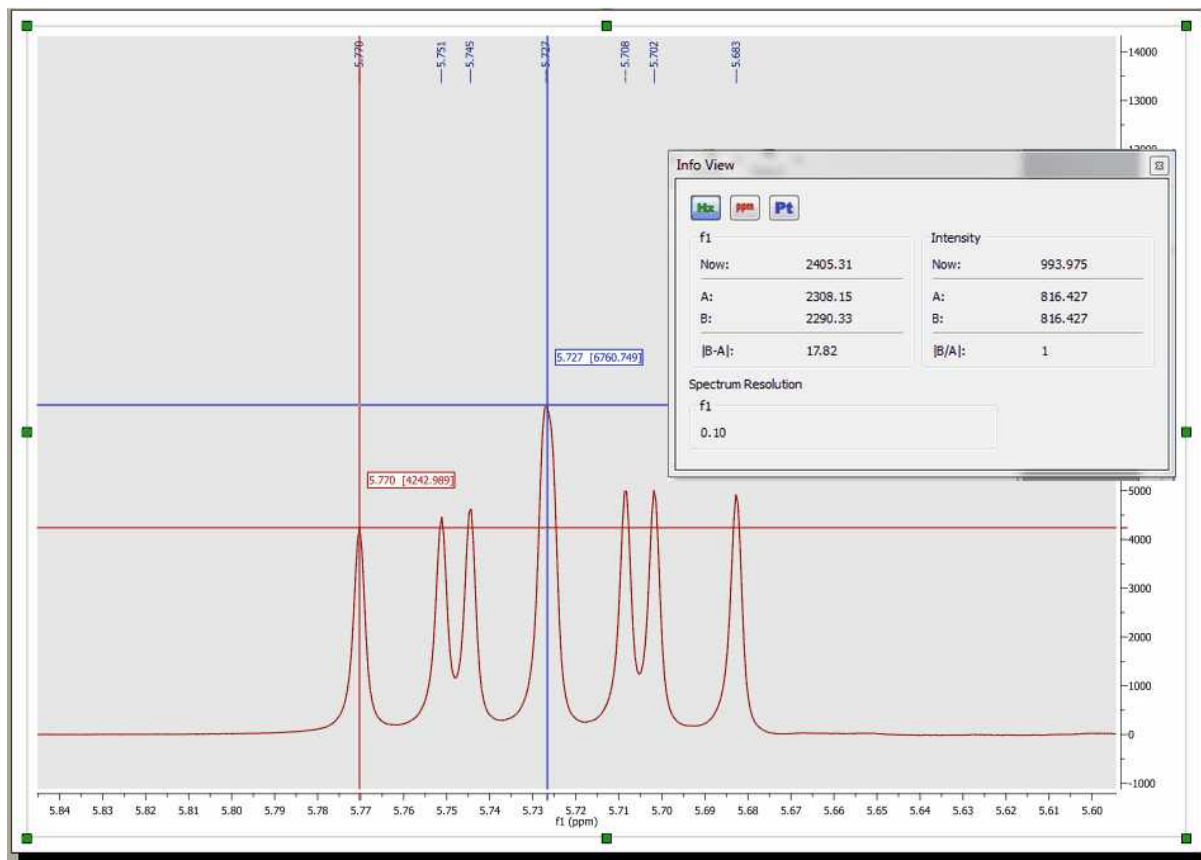

The cursor will "ride" along the 1D-NMR spectrum simplifying the location of peak maxima and minima by pressing the 'Shift' key.

7.11.1 Multiple Crosshair for 2D analysis

Double Crosshair: If you are working with COSY-like spectra (homonuclear spectra), you will obtain the **double crosshair** tool just by pressing the 'Shift' key, as you can see in the picture below:

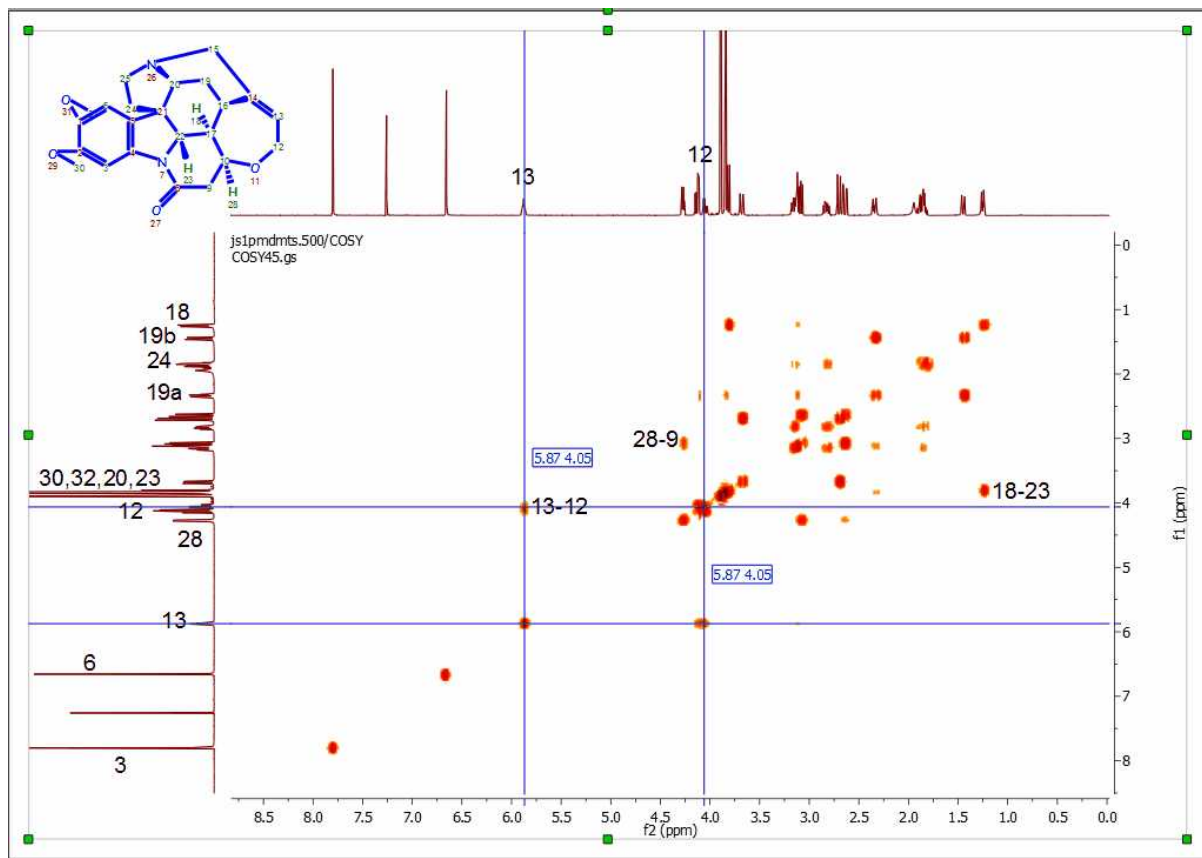

Multiple Crosshair: If you have several spectra displayed on the same page, it is possible to tie the crosshair cursors together over all the experiments by just selecting the crosshair feature in one of them. In the example below you can see how the multiple crosshair works in a HSQC, COSY and a ¹H spectrum.

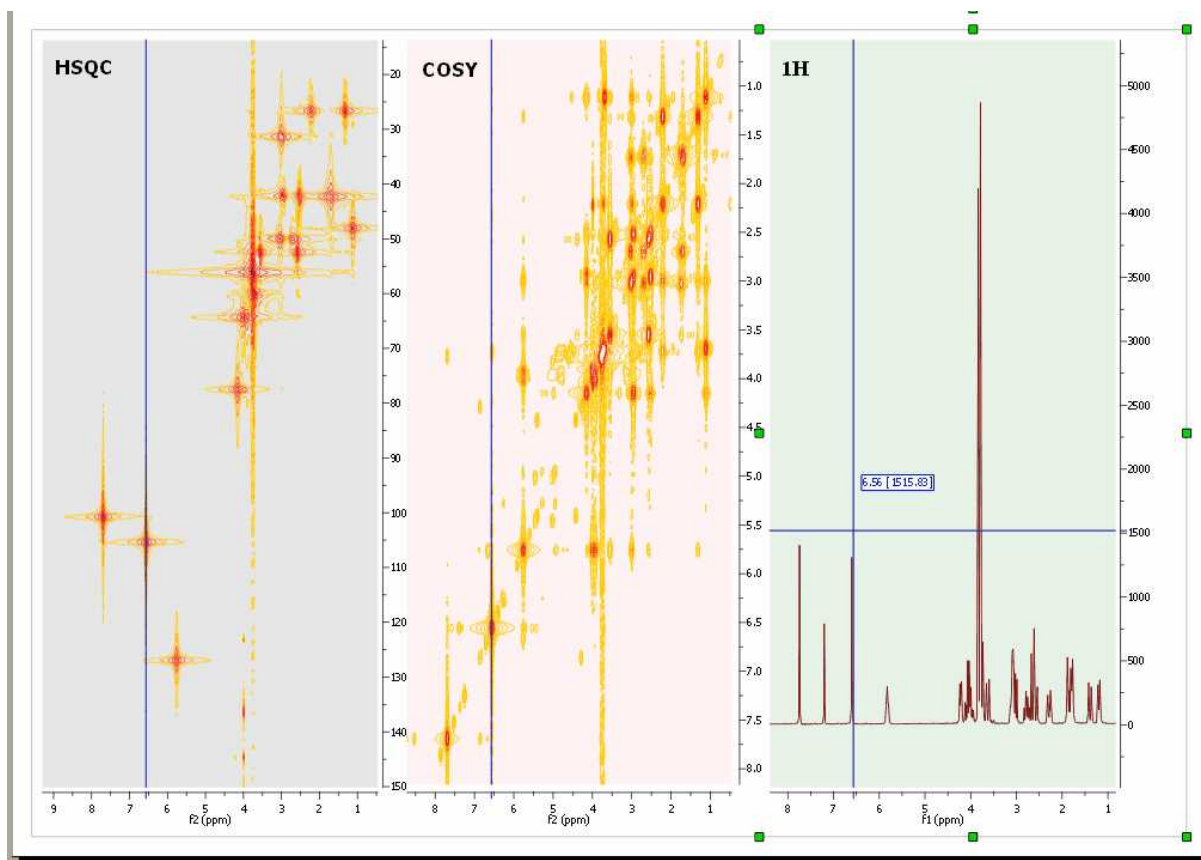

Here you can see a COSY, HMQC and HMBC (with the multiplet crosshair):

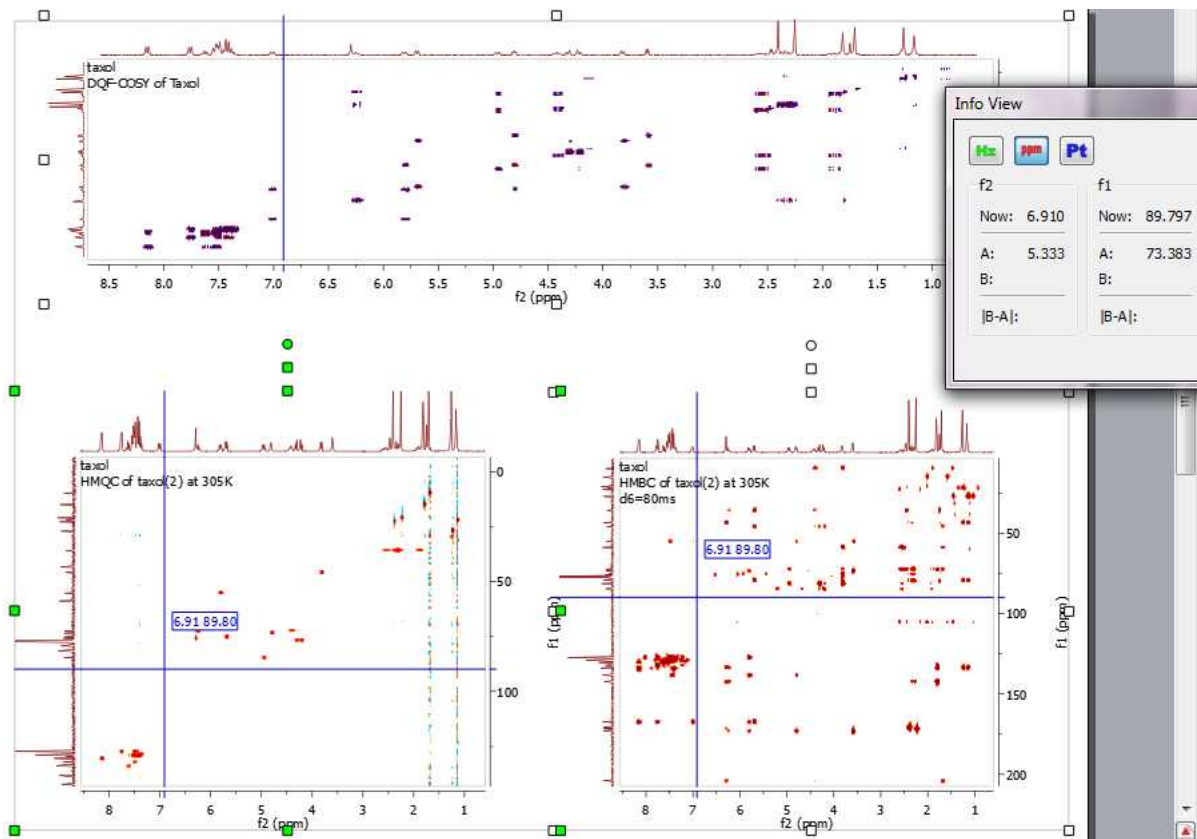

It will be also possible to get correlated cursors in stacked mode. To disable/enable the correlated cursor, just press the 'C' key:

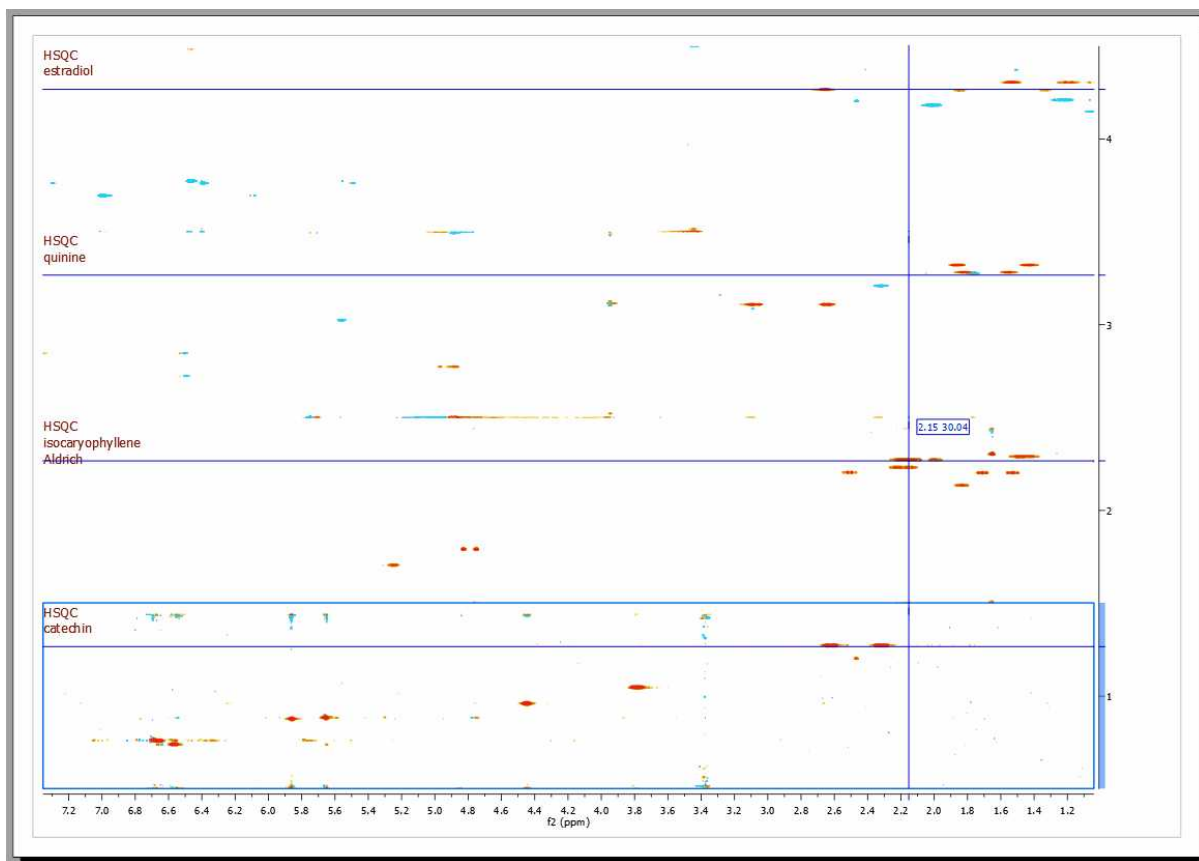

7.12 Zooming

A number of ways of zooming are available in **Mnova**.

The most common type of zooming in spectroscopy applications is the '**Zoom In**' mode. This mode can be entered by following the menu 'View/Zoom/Zoom In' or by using the '**Zoom In**' icon on the toolbar.

In this area, Mnova presents a significant innovation, allowing the user to apply 'horizontal', 'vertical' and 'box' zooms, as illustrated by the figures below.

HORIZONTAL ZOOM. Click the '**Zoom In**' icon  on the toolbar (or press <Z> key), hold down the left mouse button on the spectrum display and drag the *magnifying glass cursor* (with a red horizontal segment) across the area you want to zoom in to; a highlighted rectangle indicating the new spectral region to be displayed once the mouse is released, will follow the cursor. Use 'Undo' to revert to the previous display. A zoom lens of a 20% will be obtained by clicking on the left mouse button.

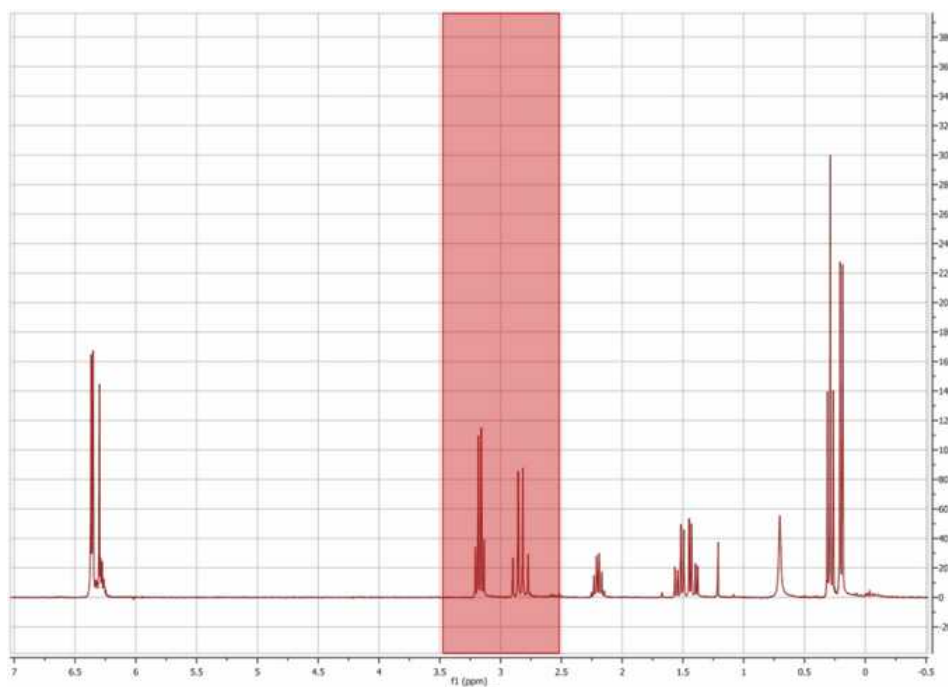

Please note that holding down 'Ctrl+Space bar' will activate the zoom in temporarily.

VERTICAL ZOOM. Click the 'Zoom In' icon  on the toolbar and then press the <Z> key (or just press twice the 'Z' key). You will see a red vertical line segment beside the mouse pointer) while the cursor is located on the spectrum display and then click and drag the cursor vertically over the area you want to zoom in on; once again you will see highlighted red rectangle.

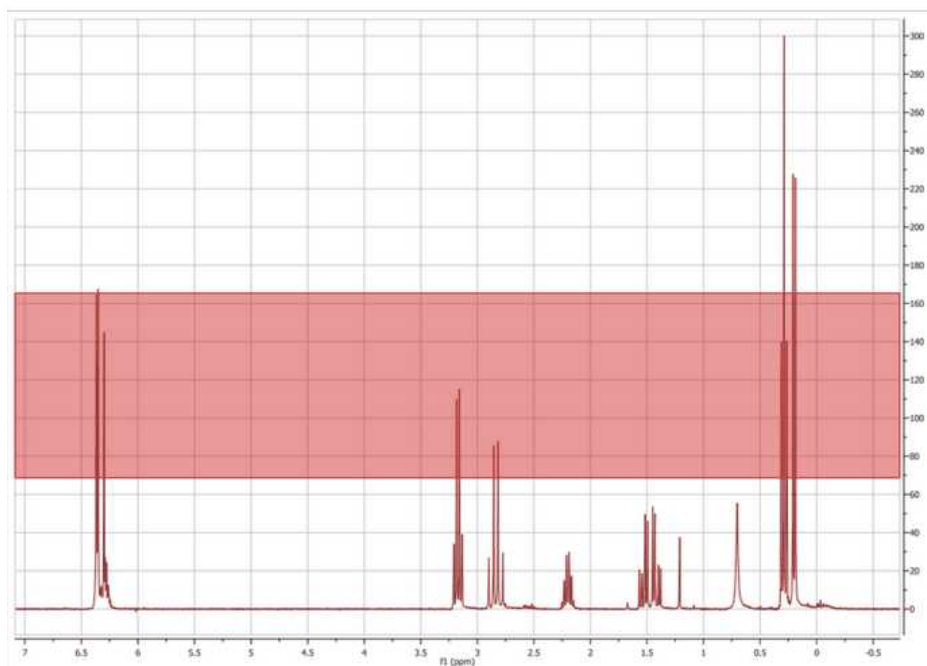

BOX ZOOM. Click the 'Zoom In' icon  on the toolbar and then press <Z> key twice with the

mouse pointer on the spectrum display (or just press three times the 'Z' key), then click and drag the cursor diagonally over the area you want to zoom in (highlighted rectangle in red). This zoom is very useful for 2D-NMR.

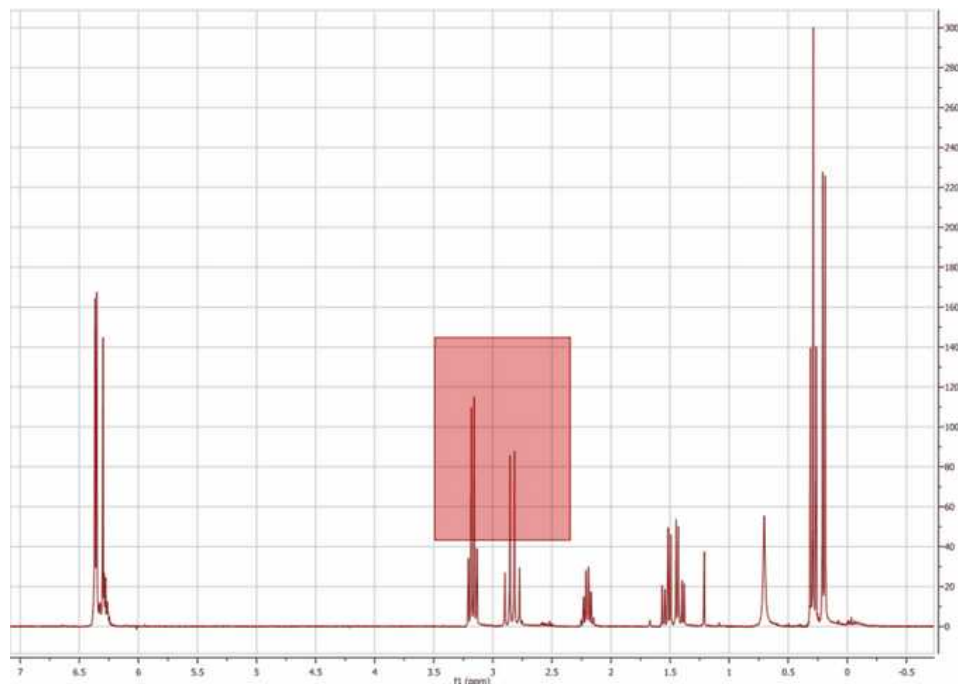

In order to switch between these three types of zoom, just press the <Z> key whilst in the 'Zoom In' mode.

ZOOM OUT: Click the 'Zoom Out' icon on the toolbar  and click on the left mouse button to obtain a zoom lens out of a 20%.

MANUAL ZOOM: Click 'Manual Zoom' on the toolbar, as you can see below:



Manual zooming is also available from the menu 'View/Zoom/Manual Zoom'. The manual zoom is slightly different in 1D to that in 2D NMR spectra where you may select spectral limits for both dimensions.

1. If you are working on a 1D-NMR spectrum, a dialog box like this will open:



You can select the limits of the spectral region of interest in ppm, Hz, points or sec and then click 'OK'.

2. If you are working on a 2D-NMR spectrum, the dialog box will look like this:

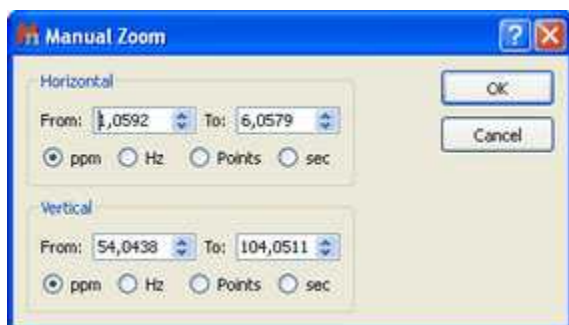

Select the horizontal and vertical limits of the region of the spectrum that you want to zoom in on, and click 'OK'.

OTHER ZOOMING MODES

1. **FULL SPECTRUM:** This tool may be used to revert to a full spectrum from a zoomed view. This may be done from the menu 'View/Zoom/Full Spectrum' or by using the '**Full Spectrum**' icon  on the toolbar.

2. **FIT TO HIGH:** The Fit to High function adjusts the display of spectral intensity in both 1D and 2D spectra so that the strongest signal is optimally displayed.

3. **FIT TO HIGHEST COMPOUND:** The Fit to Highest function adjusts the display of spectral intensity in both 1D and 2D spectra so that the strongest compound signal is optimally displayed (discarding solvent or impurity peaks).

4. **PANNING:** While the spectrum is in a zoomed state, click on the '**PAN**' icon  on the toolbar (or hold down the space bar, or hover the mouse over an axis), hold down the left mouse button and drag the *hand cursor* in any direction to navigate throughout the spectrum. In order to select vertical or horizontal panning only, press the <P> key whilst in the '**Panning**' mode.

You will be able to toggle the Full View window by using the F2 key. This will allow you to get a 'Super Fast' panning by using the Full View window..

4. **ZOOMING COMBO BOX:** In addition to the traditional '**Zoom In**' mode, **Mnova** also allows the user to apply different zooms, including Zoom Out (from a zoomed state), by using the zooming combo box.

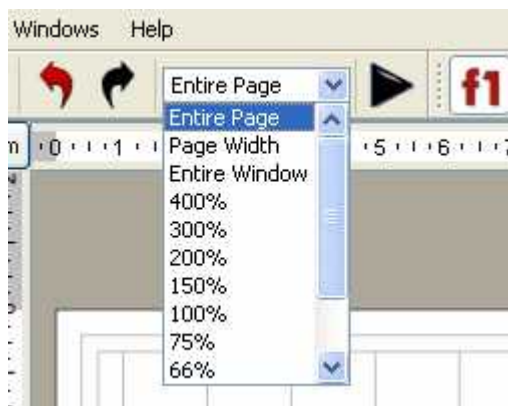

These zooming modes are:

- ✓ **Percentage zooms:** These allow different size views of the object, by selecting the different percentages available (from 400 to 25%).
- ✓ **Entire Page:** This is the standard view, which can be seen in all the figures above.
- ✓ **Page Width:** In this view, the program will fit the size of the paper to the window width, whilst preserving the original paper proportions.
- ✓ **Entire Window:** This is a special view within Mnova. It will fit the size of the paper to the size of the available window, to optimize the available screen area. This view represents an exception to the WYSIWYG concept, since in this case the proportions of the screen paper may differ from the proportions of the printer paper and therefore of what you will get when printing the page.

The **Entire Window** concept deserves further comments. For example, consider the following scenario in which the page zooming mode is set to **Entire Page**:

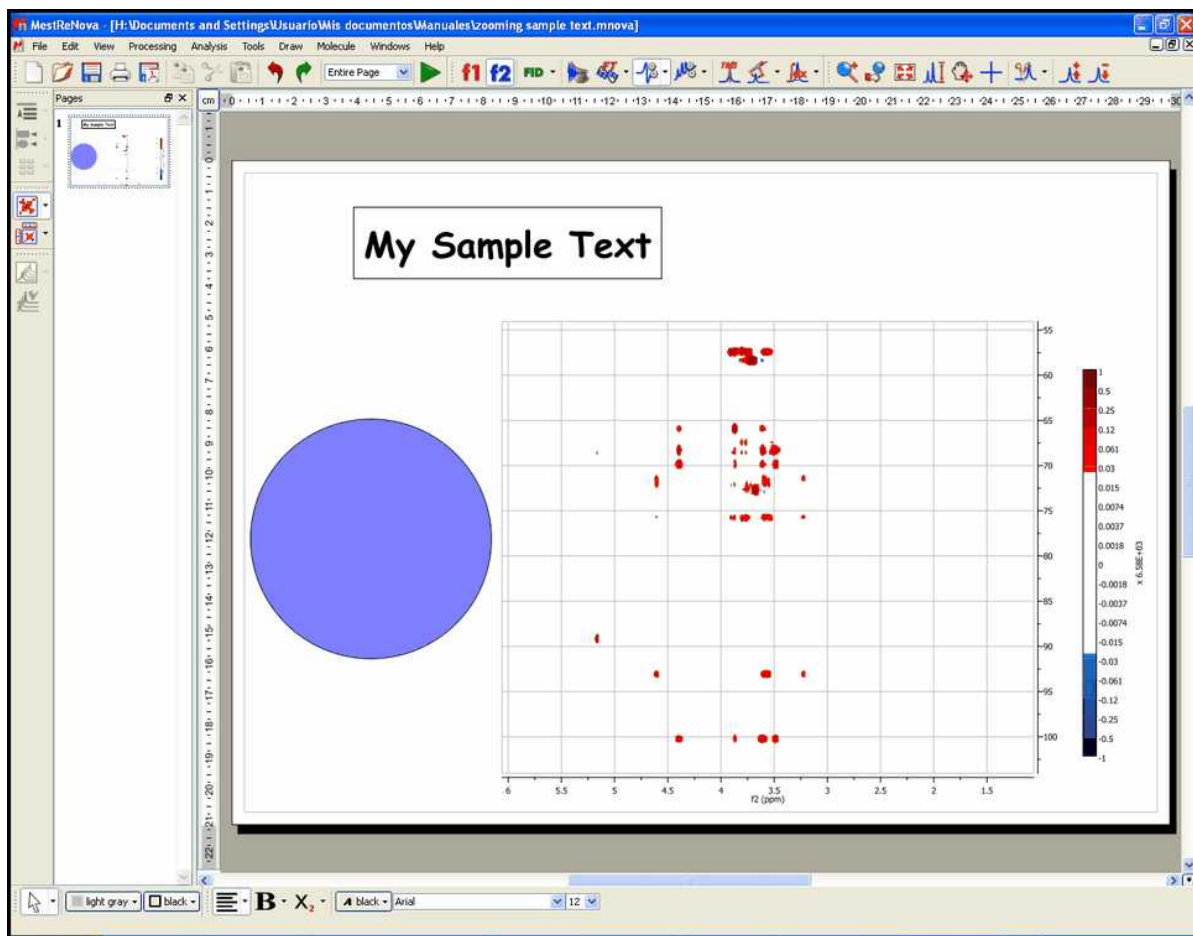

As seen in the figure above, Mnova is a fully **WYSIWYG** application. This can be appreciated in the blue circle which was created with the **ellipse** tool and then its dimensions set to form an actual circle. However, in this case there is a significant space of the window which is not covered by the page (see gray regions surrounding the page) which can be considered as wasted space. In order to make the most of the available space, we can use the so-called **Entire Window** zooming mode. In this mode, the page stretches to fit all the available space. Of course, this means that paper proportions (i.e., width/height ratio) have to be changed and thus the WYSIWYG principle is broken. As always, a picture is worth a thousand words:

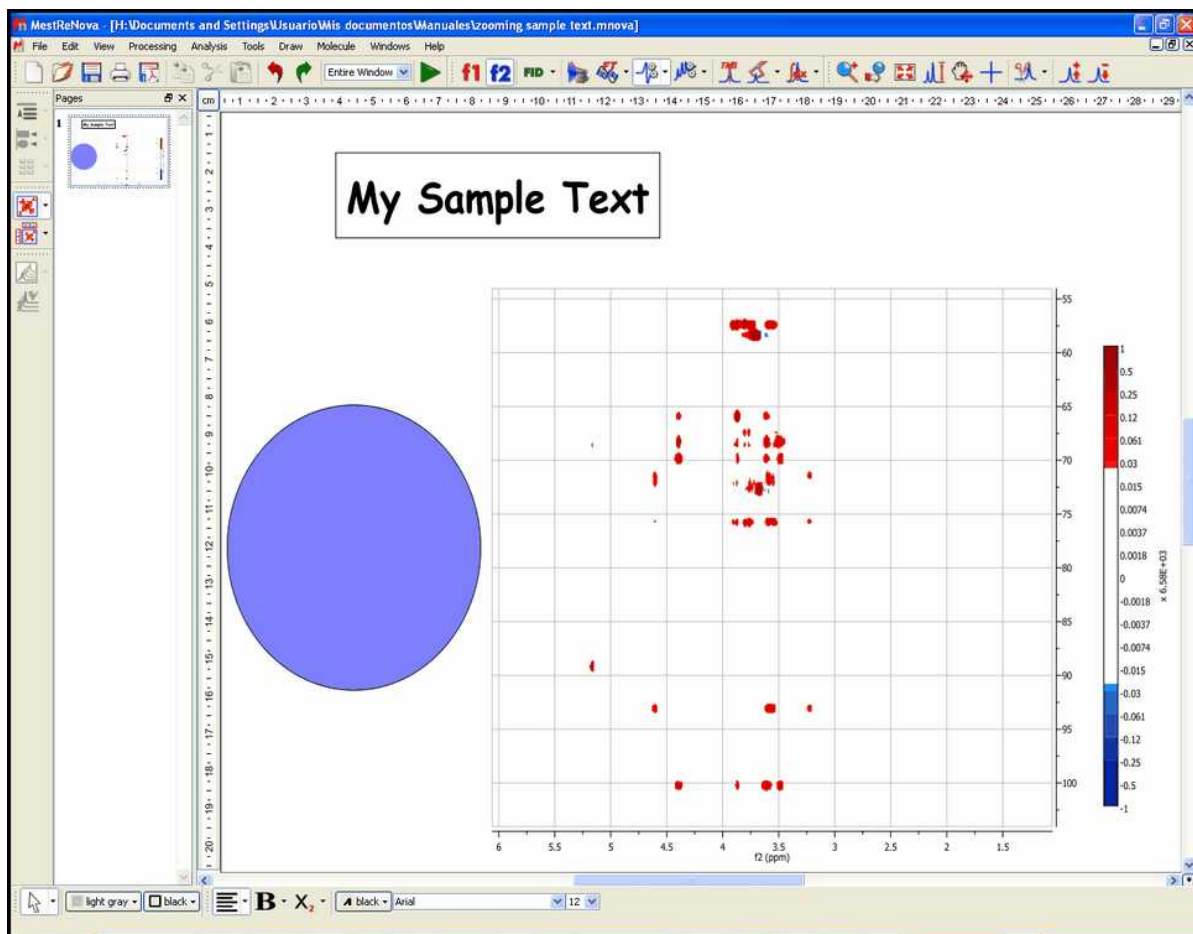

Note that all the objects are now distorted. However, this mode is very convenient to work with spectra on the screen as the graphical spectral proportions are rarely an issue. Nevertheless, if you print a document in this non WYSIWYG mode, you will get exactly the same results as when working on real WYSIWYG modes.

Please bear in mind that you can copy the zoom areas from one spectrum to another just by doing Ctrl +C in the first one and 'Edit/Paste Properties/NMR View Options':

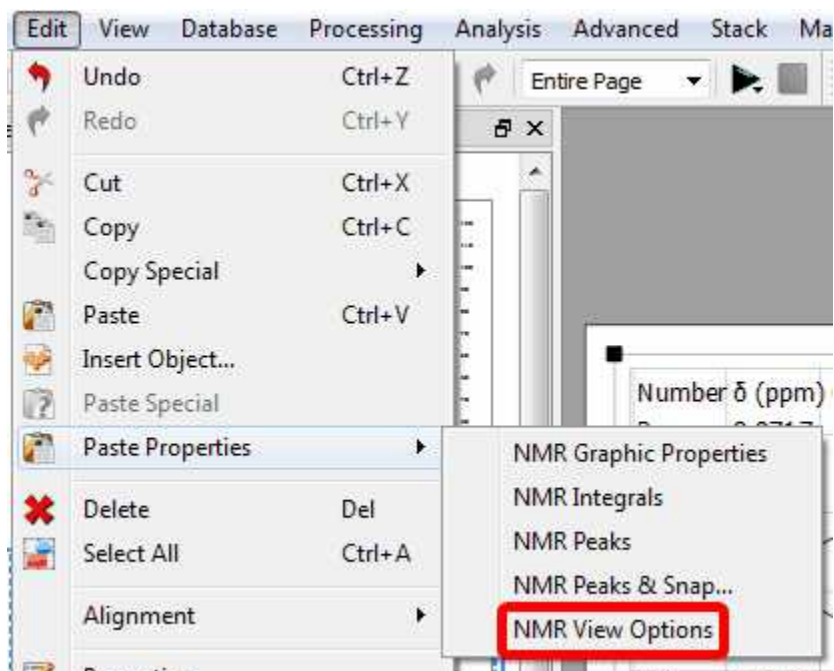

7.12.1 Full View

'Full View': (Not to be confused with 'Full Spectrum') will bring up a miniature view of the entire working document with the active area of the spectrum highlighted in blue, as you can see in the picture below:

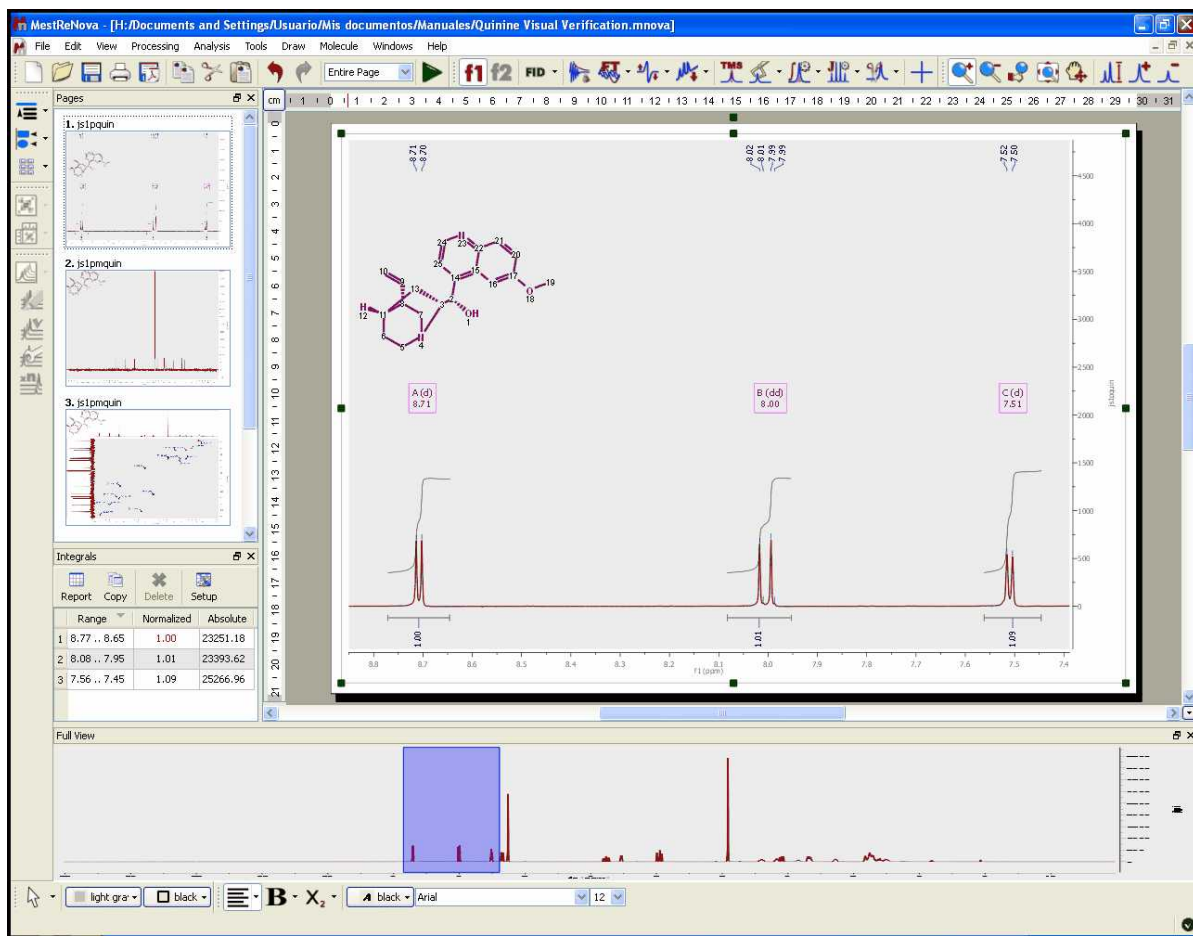

You will be able to toggle the Full View window by using the F2 key. This will allow you to get a 'Super Fast' panning.

If **'Apodization'** is selected from the Processing menu (or from the toolbar icon ) then the **'Full View'** switches to show the FID and the effective window function. This allows you to manipulate the FID (using apodization for example) and observe the effect on both the FID and the spectrum.

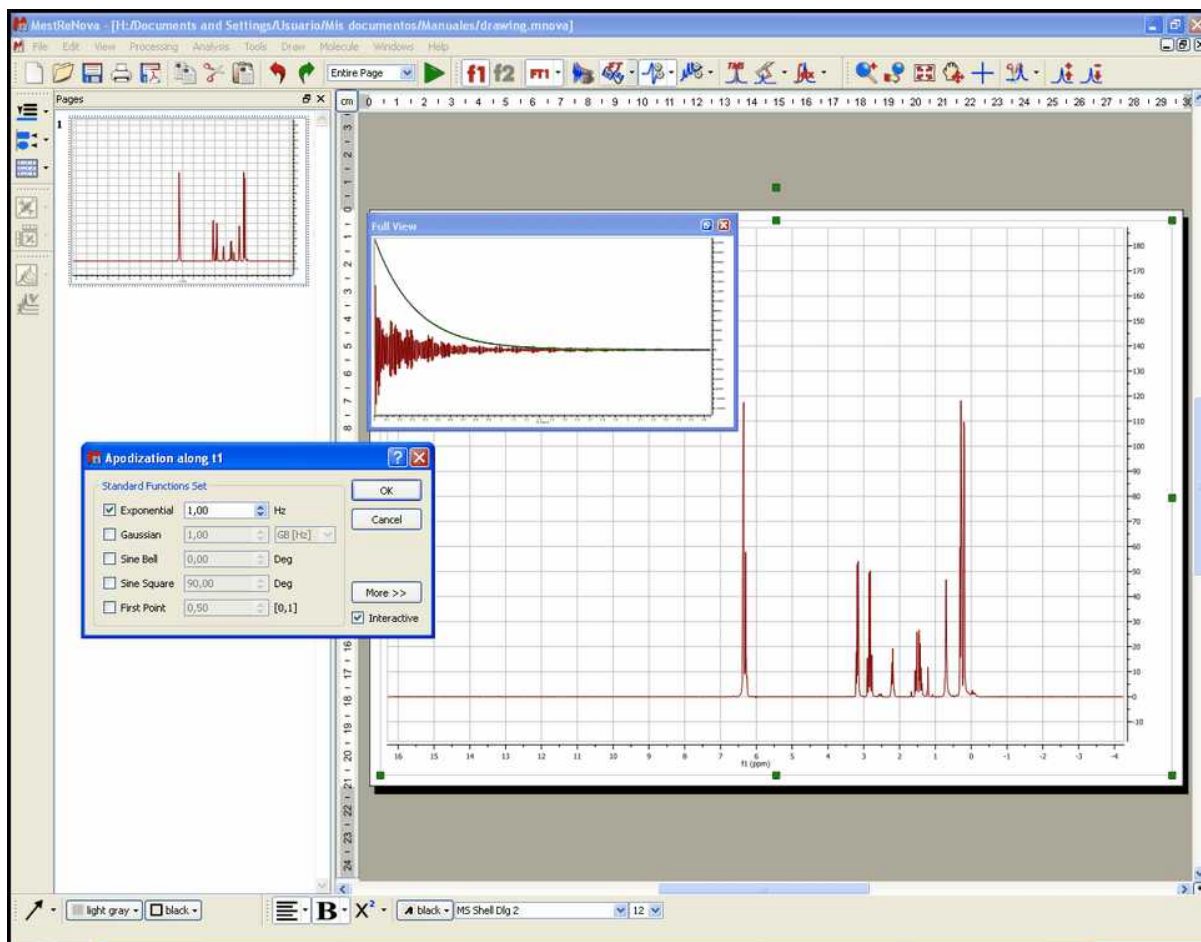

7.12.2 Create Expansions

It is possible to create expansions with Mnova just by clicking on the corresponding icon of the toolbar  (or by pressing the <E> key) and then holding down the left mouse button and dragging the *magnifying glass cursor* (with a red horizontal segment) over the area of interest. A highlighted rectangle indicating the new spectral region to be expanded once the mouse is released, will follow the cursor. You can see in the picture below an example of this feature:

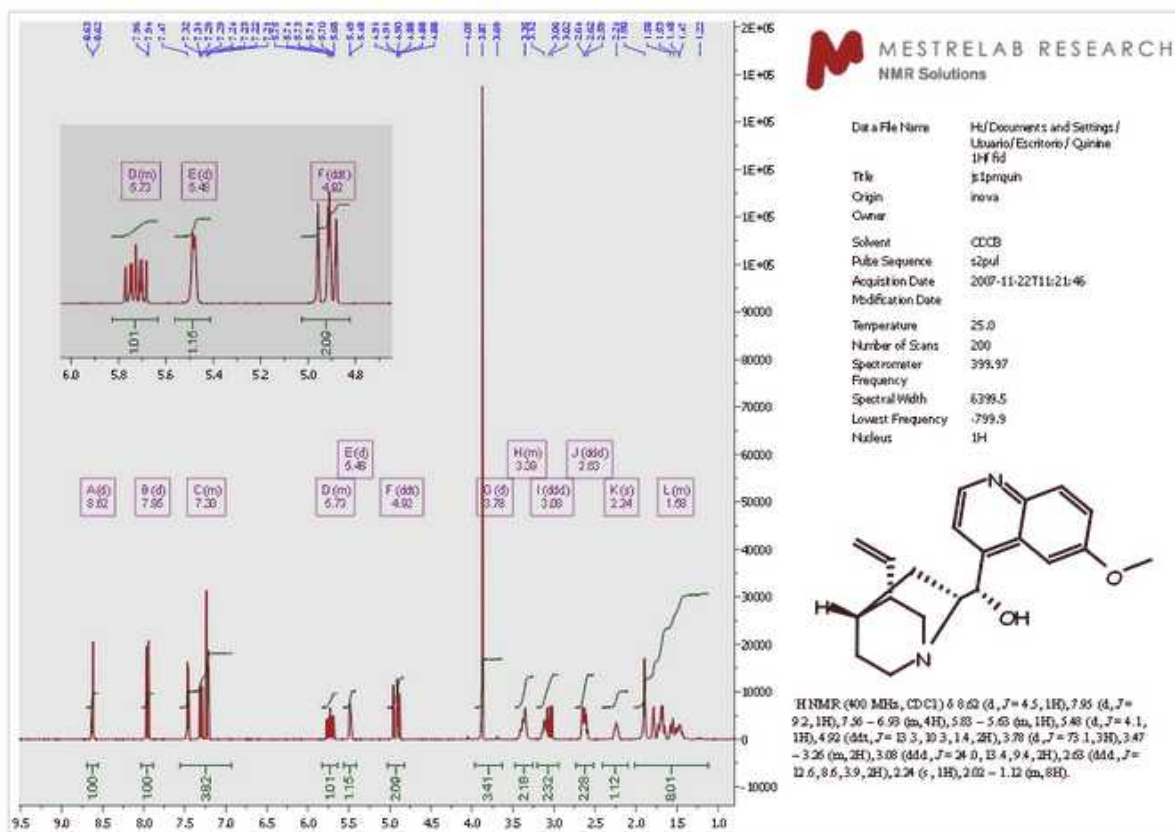

7.13 Cutting Spectra

THE SPECTRUM CUTTING TOOL

This is a tool that most **Mnova** users will not have seen before (with the notable exception of **iNMR** users). It is important to note that this tool is in no way related to the "copy", "cut" and "Paste" object manipulating tools found in this and most Windows programs as Icons and in the Edit drop-down window. The **'Cutting'** tool allows the user to create **dark** regions, i.e., to hide areas of the spectrum the user is not interested in seeing (these could be noise regions or other regions which are of no interest at a specific time). By hiding these regions, areas of interest become larger on the screen without a need to create numerous expansion windows. The Cutting Tool is basically a way of split zooming, as opposed to the more limited traditional zooming in a single block. The hidden areas are shown on the scale and on the grid. The software also implements an **Auto Cut tool**, which will hide all noise-only regions of the spectrum at the click of one button.

It is important to stress that this tool is not eliminating the information, but simply not displaying it. The 'Cut' and 'Auto Cut' options are available from following the menu item 'View/Cuts/Cut' or 'View/Cuts/Auto Cut'. Manual cutting can also be accessed by clicking on the **'Cut'** icon (or simply, by pressing the <X> key) as can be seen in the figure below. Auto Cut can be accessed via the drop-down menu which can be displayed by clicking on the side-bar of the Cutting Icon.

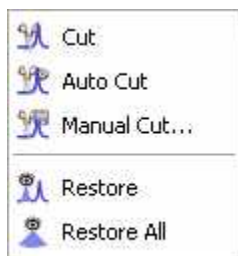

It is also possible to **restore** one specific region ('Restore', or <V> key), a limited region ('Manual Restore') or all regions ('Restore All'). These options can be selected from the menu 'View/Cuts/Restore', 'View/Cuts/Manual Restore' and 'View/Cuts/Restore All' or by selecting 'Restore', 'Manual Restore' or 'Restore All' in the scroll menu shown in the figure below.

By the way, you should also note that the 'Cut' mode is available in 2D, along direct, indirect or both dimensions. Once again, switching between modes is achieved by simply pressing the <X> key.

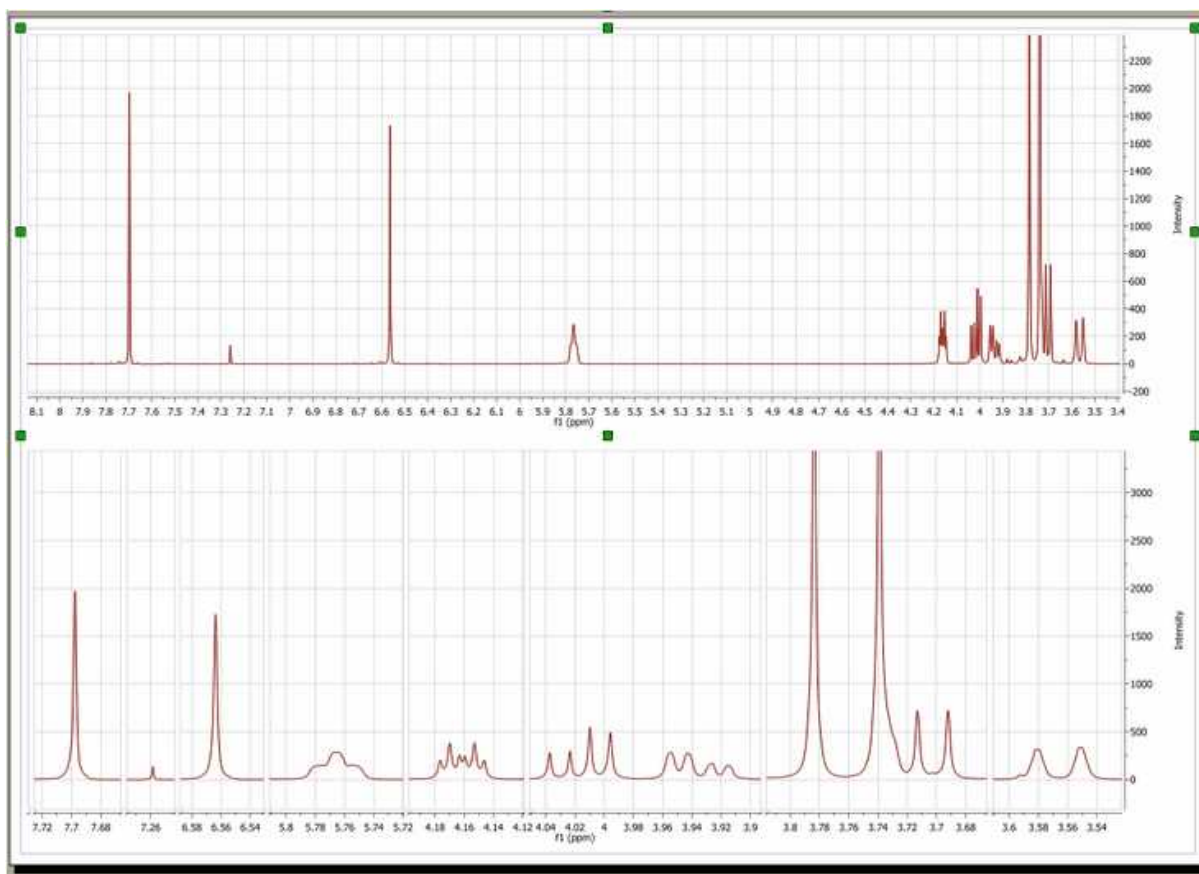

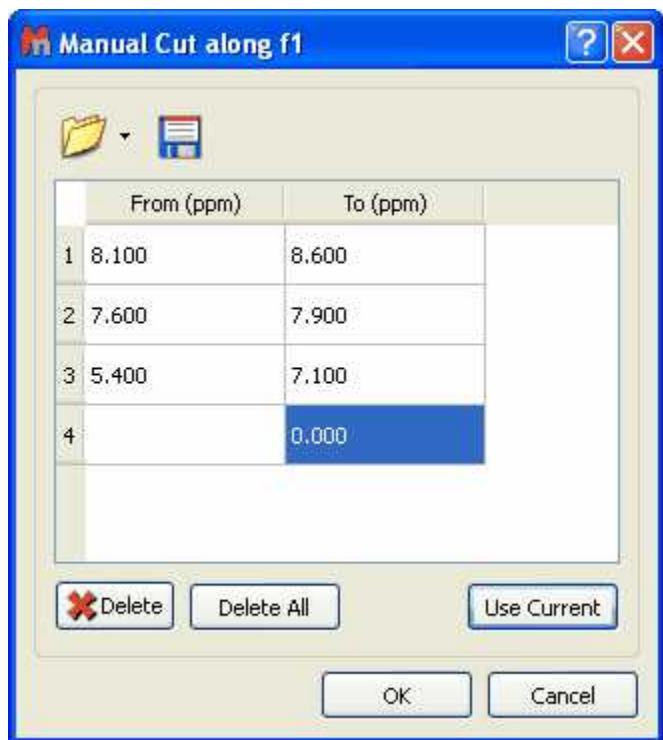

Manual Cutting

The user will be also able to use the 'Manual Cut' to select the limits of the dark regions.



The user will be able to predefine the cuts ranges to automate the cutting analysis. **Clicking on OK, will cut the current spectrum with the desired ranges and keep the regions to apply further cuts to additional spectra.**

The user will be able to save these regions for later uses, by clicking on the **'Save Cuts'** icon  which will be loaded by clicking on the **'Load Cuts'** icon .

7.14 Increasing and Decreasing Intensity

The two icons  towards the right of the standard toolbar allow the user to interactively scale the data of the NMR spectrum. This operation does not modify the acquisition or the MestreNova data file; it only magnifies or diminishes the representation of the data which you see on your screen. You can also find these options via the 'View/Increase Intensity' and 'View/Decrease Intensity' menus. Additionally, you can use the '+' key to increase or the '-' key to decrease the intensity and the same effects may be obtained by rotating the scroll wheel of the mouse.

The intensity increases/decreases 10 times slower if the user press the Ctrl key while moving the mouse wheel.

7.15 Undo & Redo



Undo is a very useful command; it erases the last change made to the document, causing the document to revert to an earlier state. The **Redo** command reverses the undo.

Mnova has very powerful **Undo** and **Redo** capabilities. These can be applied to virtually any

operations carried out by Mnova, from creation of pages and opening of documents through zooming, panning, and annotating, to any processing or analysis operations. Undo & Redo in Mnova are virtually unlimited (RAM memory limitations may apply). These options can be found as the toolbar icons shown above or via the 'Edit/Undo' and 'Edit/Redo' menus. Additionally, there are keyboard shortcuts for these operations, <Ctrl+Z> (or Cmd+Z for Mac) for Undo and <Ctrl+Y> (or Cmd+Y for Mac) for Redo.

7.16 Graphics and Annotations

Mnova has the most powerful graphics and annotation capabilities available in any NMR software. Most of the annotations and drawing available in MS Powerpoint are available in Mnova via the graphics toolbar placed by default at the bottom of the screen, below the page navigator and the document area. The software supports Rich Text and so a wide range of fonts and font embellishments (sub- and superscript, bold, italic etc) are available.

Mnova can import objects such as **molecular structures** using Edit/Insert Object while **images** may be embedded using the standard Windows Copy and Paste tools.

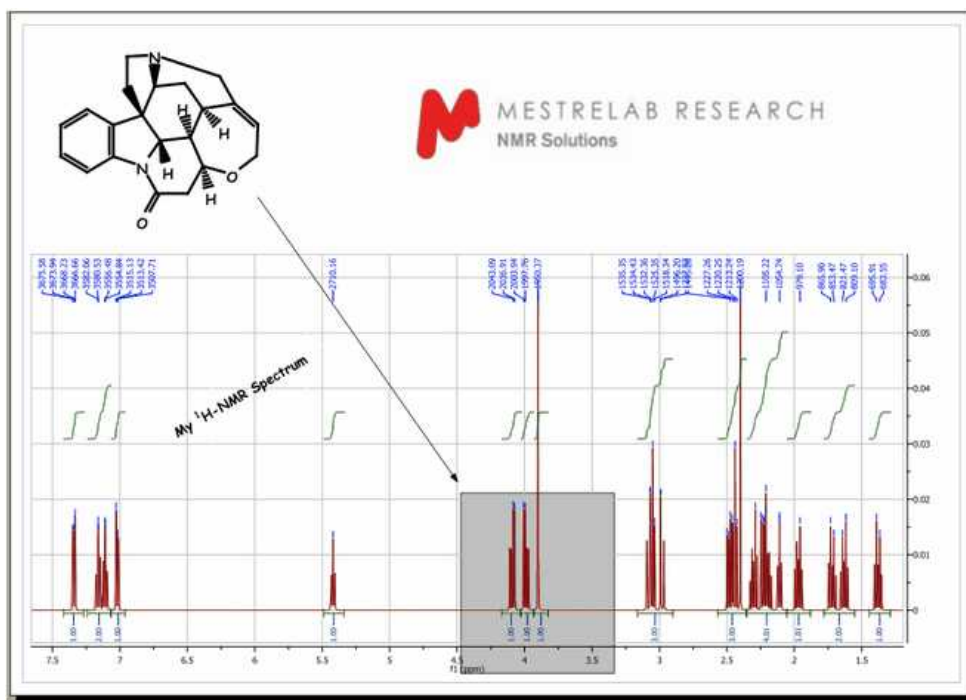

You can draw a line, an arrow, a rectangle, an ellipse or a polygon by following the menu 'Edit/Annotate' or by using the graphic toolbar, as you can see below. Once you have selected the object you want to draw, hold down the left mouse button in the spectrum display and drag the cursor over the area where the line or shape is to be drawn. Once created the line/shape may be moved, rotated and resized by selecting it and using the object's moving, sizing and rotating "tabs". You can also choose the fill color (light grey as default) as well as the colour and linewidth of the border of the object (black as default). Text may be added to the document in much the same way. The text can be aligned (right or left justified or centred) and you can select the text features **Bold**, *Italic* and Underline, sub- and superscript and the font (color, type and point size).

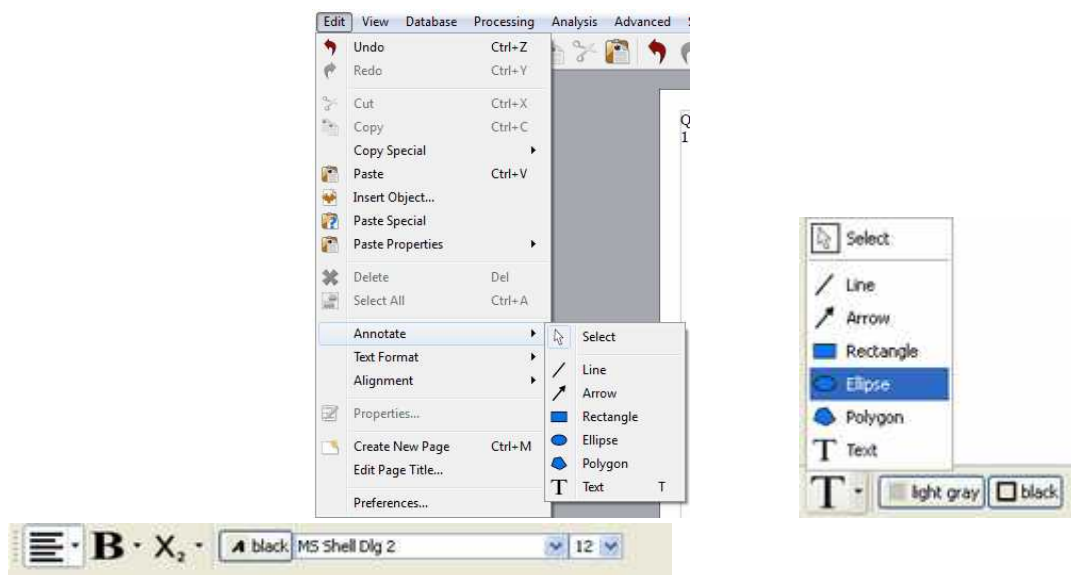

Part



8 Processing Basics

Our aim in developing Mnova has been to make the opening, processing, handling, analysis, saving and printing of NMR data simpler than it has ever been before, so that even the NMR novice can enjoy the software and obtain excellent results from the very start.

Mnova introduces a brand new NMR data processing paradigm; when a raw, unprocessed spectrum (FID) is opened, you will get the fully processed spectrum instantaneously.

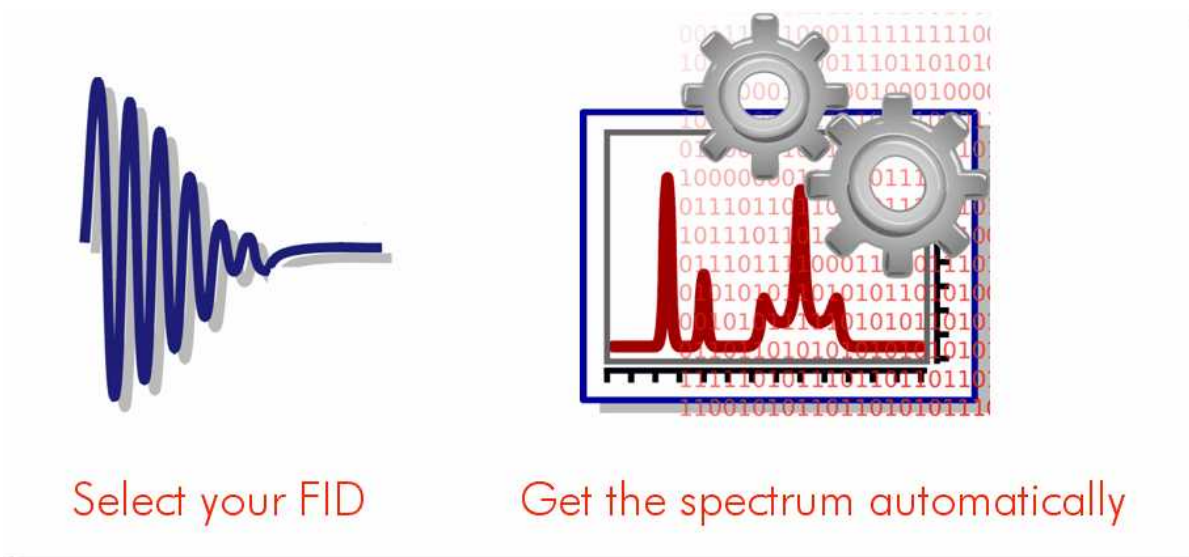

This new concept is very simple and consists of two fundamental points:

1. **Automatic File Format Recognition:** Once you select the FID, Mnova will automatically identify its origin (e.g. Varian, Bruker, Jeol, etc).
2. **Fully Automatic Processing:** Once the FID is opened Mnova will automatically and optimally process it using the information it discovered in Part 1, so you do not need to bother with processing details.

The two steps outlined above will successfully process most NMR data. However, if you are not completely satisfied with the result you can, at anytime, reprocess using your own choice of processing parameters, changing or adjusting the window function, the FT, the phasing and baseline correction to meet your requirements.

With this scheme, processing of 1D and 2D spectra is essentially identical as you will see in the following two tutorials:

[1D NMR Processing](#)

[2D NMR Processing](#)

8.1 1D NMR Processing Tour

Opening the data set

In pulsed NMR spectroscopy we obtain what is called a *time-domain signal* since the measured signal is a function of time; all the nuclear resonances decay from the same starting time to form the Free Induction Decay or FID. This kind of signal is not readily interpretable by the human eye, and so it is necessary to transform it (into the frequency domain) using a Fourier transformation (FT) to display the

separate nuclear resonances as a frequency spectrum.



There is one single command for opening all types of files in **Mnova**. It is not necessary for the user to have any knowledge about the way in which the experiment has been acquired. **Mnova** will automatically recognize most common spectrometer file formats and acquisition modes and will apply the necessary processing operations.

To open your data (including mol files and graphics files), just go to '**File/Open**' menu, use the keyboard shortcut **<Ctrl+O>** (or Cmd+O for Mac) or click on the '**Open**' icon on the toolbar (note that this is exactly the same for 1D and 2D data). You can also drag&drop into Mnova, the folder containing the FID (the FID must be in the first level of folders)



Once this command has been issued, navigate through your disk to find the NMR experiment of interest and select the desired FID file which is normally named **fid**; however in Bruker 2D experiments the time domain data is named **ser** (serial fid). After selecting this file, the first thing you will notice is that the spectrum will open **already processed**, despite the fact that you are opening raw data (FID). When opening files, Mnova will apply the necessary processing operations, selecting the correct processing parameters from the spectrometer files. If these parameters are not available (e.g. phase parameters are not available), Mnova will use automatic algorithms (e.g. automatic phase correction) and will apply them to the data set. Thus, even a completely inexperienced chemist, working with NMR for the first time, should be able to get good results when processing both 1D and 2D spectra.

In the figure below you will see what happens when the FID is opened:

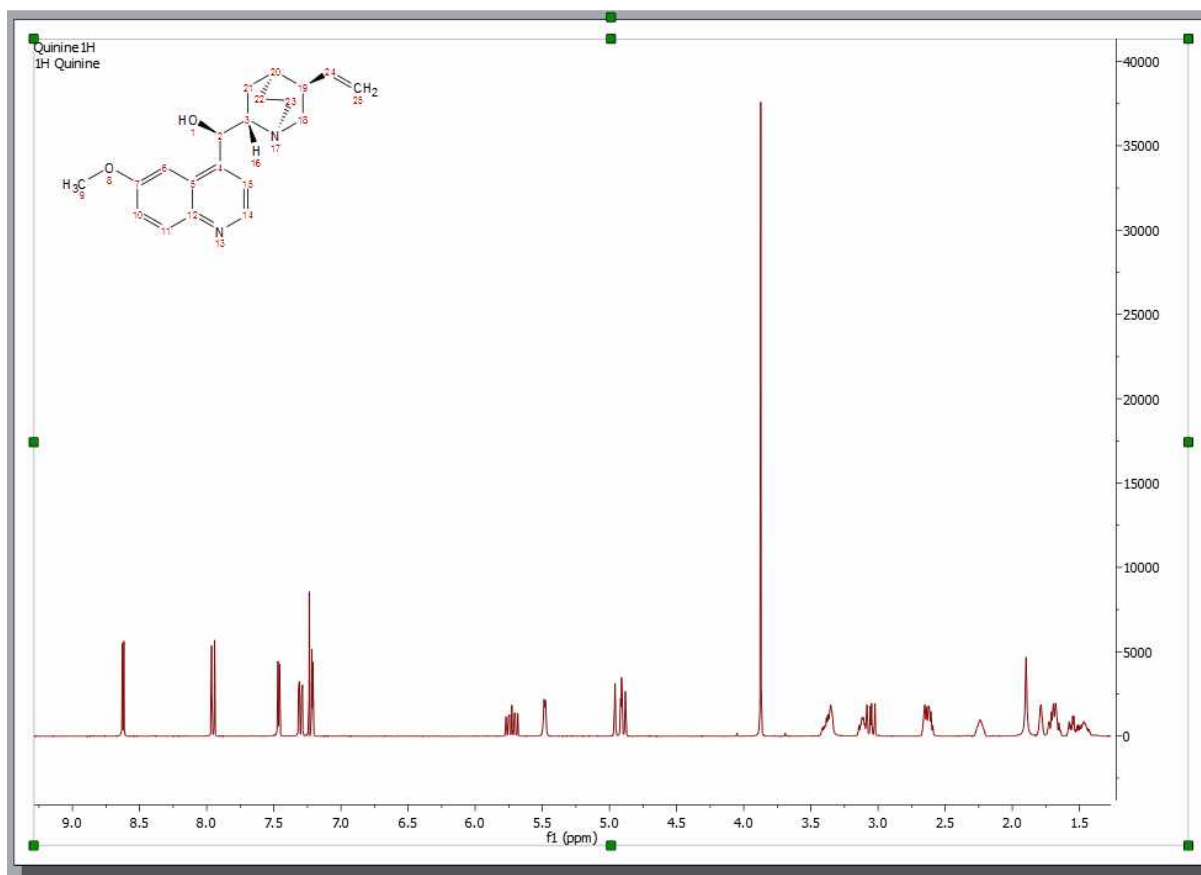

As explained above, the FID is automatically processed. In this case, the native files contained values for phase correction and thus Mnova utilized them for phasing. However, as you can appreciate, the result is not good enough (most likely because the spectrum was processed in the spectrometer computer using an inefficient automatic phase correction algorithm). Later we will show how to improve the phase of this spectrum by applying first the automatic phase correction algorithm implemented in Mnova and finally using manual phase correction. Remember that if the native files do not contain values for phase correction, Mnova will apply an automatic phase correction.

Even though you have opened a FID and you see only the processed spectrum in Mnova, it is possible to see the **original FID and the processed FID** (Processed FID or **FID'**). When we process the raw data on-the-fly, we do not discard these data, we just do not display them. The user can view the FID by just clicking on the **'FID'** icon on the toolbar (in the red circle in the figure below).



There are several options in the scroll down menu:

- **FID**: Clicking on this option will show the original *time-domain signal* (FID) as it was when ported

from the spectrometer.

- **FID'**: Clicking on this option will show the FID after time-domain processing functions have been applied (i.e., immediately prior to FT)
- **FT**: Clicking on this option will show the data after FT along the direct dimension (spectrum for 1D data, interferogram in 2D data)
- **FT2**: Clicking on this option will show the data after FT along two dimensions (2D spectrum)

For example, this is the original FID of our test spectrum:

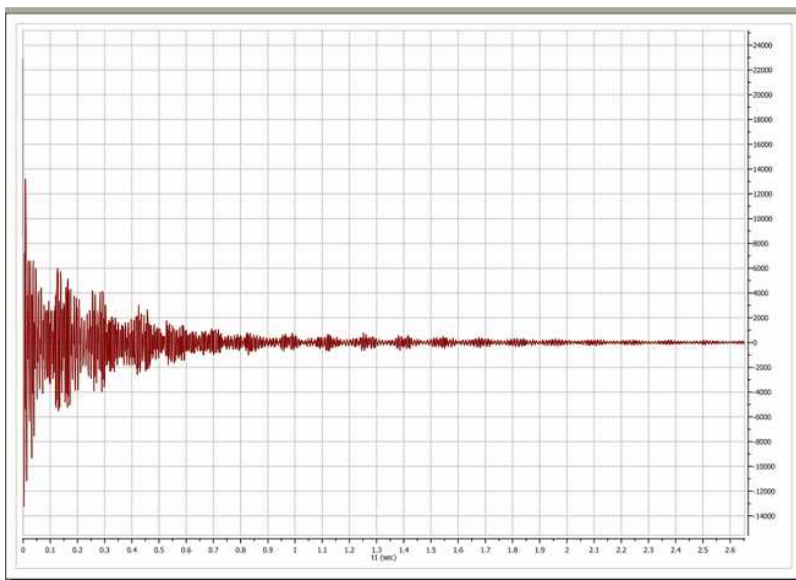

And this is the so-called **FID'**. In this case, prior to FT, Mnova applies a zero filling operation as can be appreciated in the FID' below. A zero fill increases the digital resolution by adding null data to the FID, increasing the size of the data array.

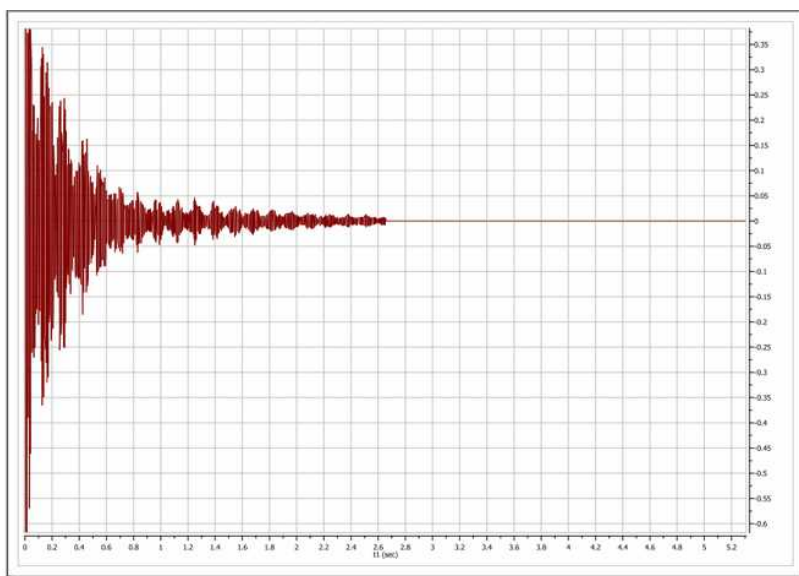

You can switch at any time between any of the displays (FID, FID' and processed spectrum).

Interactive Processing: Real Time Frequency Domain Processing

As we saw in the previous section, Mnova will keep all pre, during and post processing information together with the spectrum we can see on the screen. This fact, combined with the extremely fast and optimized processing algorithms implemented in Mnova, allows us to introduce to NMR processing the concept of **'Real Time Frequency Domain Processing'**, designed to greatly simplify processing for the user and to ensure faster and better results even when complicated operations are applied to the data.

The way this concept works is very simple: Reprocessing of the spectrum is possible at any time, independently of the time domain and frequency domain operations which may have been applied to the data set (for example, it is possible to change the window function after having applied a FT, phase and baseline correction). This is possible because, in the background, Mnova is going back to the FID and reprocessing the spectrum by applying the new functions or parameters as well as all the other functions applied *ad posteriori* on the previous processing. The very important advantage for the user is that it is now possible to see, in **real time**, the effect of any processing operation (including time domain operations) on the resulting frequency domain spectrum (for example, you can apply a more drastic exponential apodization function and see in real time, on screen, what effect this is having on the resolution and sensitivity of the frequency domain spectrum).

In the figure below, you can see the frequency domain 1D spectrum, the FID with the window function which is being applied interactively (which is shown graphically in the 'Full View' window (go to the 'View/Full View' menu to activate), and also the Apodization dialog box - note that the 'Interactive' box is ticked). The user can follow the exact effect of the function s/he is applying on the frequency domain spectrum. This can avoid repeated transformation and reloading of the data while the optimum processing parameters are sought and, of course, act as an excellent teaching and self-teaching tool for those who are not conversant with the effects of different processing parameters.

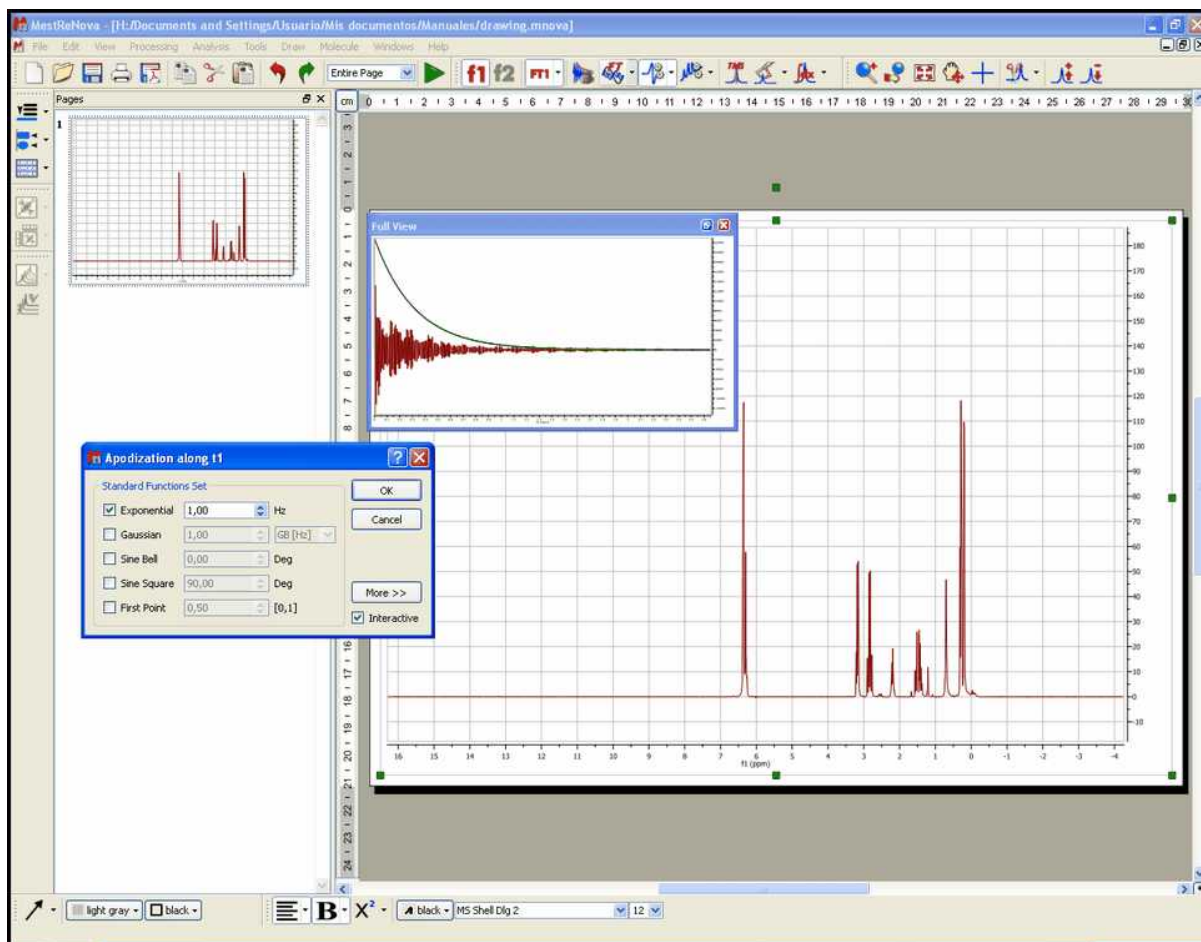

This same principle can be applied to all other processing operations, such as Zero Filling, Linear Prediction, Signal Suppression, etc. For example, if we want to increase the digital resolution of the spectrum, we can increase the number of points used in the FT operation by selecting **Zero Filling**.

Of course, standard frequency domain operations such as [phase correction](#) or [baseline correction](#) can be applied in the traditional way.

See also:

[Phase Correction](#)

[Baseline Correction](#)

8.2 2D NMR Processing Tour

(Not available in Mnova Lite)

1D experiments contain a wealth of information but this information is often obscured due to signal overlap. Homonuclear couplings are often more readily and rapidly determined by extension into a second dimension. Heteronuclear couplings (^1H - ^{13}C for example) are much easier to determine using two frequency dimensions. 2D experiments which use one frequency dimension and some other variable on the other axis (the DOSY processed STE experiment for example with diffusion coefficient on one axis) exist but this tour will concern two frequency (chemical shift) dimensions.

These 2D spectra are collected as time domain data dependant upon two time variables (t_1 and t_2) and after two orthogonal Fourier transformations a frequency spectrum which is a function of two frequency

variables results. The general scheme for these **two** dimensional experiments is shown in the pulse sequence below:

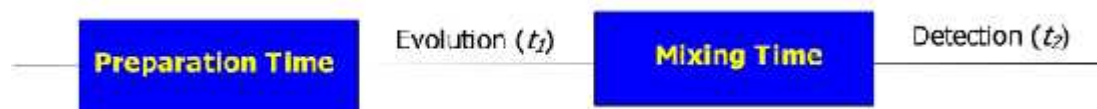

In the *Preparation Time*, the sample is excited by one or more pulses and the spin system is placed in a non-equilibrium state which will evolve later. During the *evolution* period, the resulting magnetization evolves freely. Each signal will evolve with its characteristic frequency. Then follows the *Mixing Time* containing a further pulse or pulses; it is in this period that, for example, magnetization, may be transferred from proton to ^{13}C during indirect detection. Finally the signal is recorded (detected) as a function of the second time variable, t_2 ; the signal has, however, been frequency-labelled as a function of t_1 .

After acquiring a bidimensional experiment, you will have a matrix of data; the rows contain data collected at fixed values of t_1 with t_2 varying; they are, in fact, normal 1D data FIDs. The columns contain data collected at fixed values of t_2 with t_1 varying and are "synthetic" 1D FIDs. This matrix will be Fourier transformed twice, once for the rows and again for the columns. In this way, the time dimensions (t_1 and t_2) are converted into frequency dimensions (f_1 and f_2).

In a 2D-NMR experiment we can find any nucleus represented on either of the dimensions of the spectrum, so the spectrum can show correlations between the same nuclei ($^1\text{H}/^1\text{H}$) or different nuclei (such as $^1\text{H}/^{13}\text{C}$, $^1\text{H}/^{15}\text{N}$, $^1\text{H}/^{31}\text{P}$, etc...). In a 2D-NMR spectrum, the acquisition dimension (t_2) is the dimension in which we can obtain the greater number of data points without a considerable increase of the acquisition time. On the other hand, each point acquired in dimension t_1 , multiplies the necessary number of scans, considerably increasing the total acquisition time. For this reason, in many cases the number of data points acquired along the t_1 dimension is much smaller than along t_2 , although this number of points must always be sufficient to provide adequate f_1 resolution. The "synthetic" f_1 FIDs are generally truncated and may benefit from forward linear prediction.

Processing of 2D NMR data sets with Mnova is almost as easy as processing 1D NMR data. You simply select the FID file (or SER file in Bruker) and the 2D spectrum appears on your screen without the need to touch a single button.

In this tutorial we will show how to process a 2D experiment. This tour will guide you through all the necessary steps to process, display, and print out two dimensional spectra with Mnova. Before you attempt to process a 2D spectrum, please read the [1D NMR Processing Tour](#) since you need to be able to process 1D spectra also.

Multidimensional (or bidimensional) data processing requires only a few new concepts when compared with 1D NMR data processing. A 1D-NMR spectrum can be considered as a single vector of data points and its transformation into the frequency domain only requires only one FT. In the case of 2D spectra we have a two dimensional matrix of points and it is necessary to Fourier transform both rows and columns.

In 2D homo- and heteronuclear NMR the matrix of points results from an array of 1D FIDs which are functions of t_2 due to their detection (sampling of the FID at intervals of Δt_2) and t_1 since each successive FID the value of t_1 which determined the evolution time, is incremented. The first row has $t_1 = 0$, the second row has $t_1 = \Delta_1$, the third row has $t_1 = 2\Delta_1$ and so on. The same happens with the data columns, although in this case the sample interval is different (Δ_2).

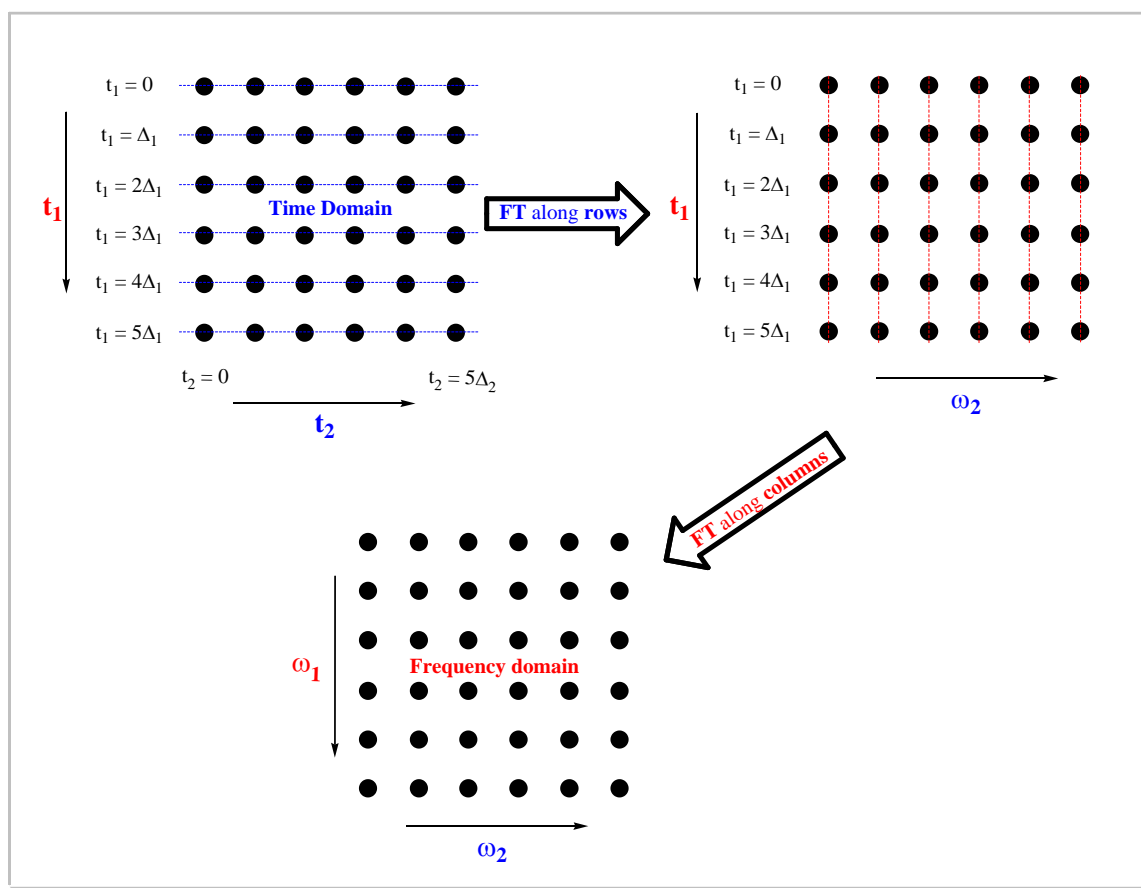

As you can see in the picture above, the first step is the application of the FT along the rows of the matrix; to obtain a new matrix (*interferogram*) where each row corresponds to an increasing value of t_1 and each column to a running frequency variable ω_2 . Next the columns are subjected to a FT to obtain the final matrix (2D spectrum) where the frequency axes (ω_1) corresponds to the evolution in t_1 , while ω_2 corresponds to the evolution in t_2 .

This 2D data can be processed using apodization functions and once you obtain the 2D spectrum, you can apply a phase or a baseline correction as with 1D processing. One important point is that processing operations need to be performed along each dimension. In Mnova, the processing is always started along the acquisition dimension, and finished along the indirect dimension.

In this example we will use a Bruker spectrum so you will need to select the **ser** file. Once you do so, you will immediately obtain the processed spectrum:

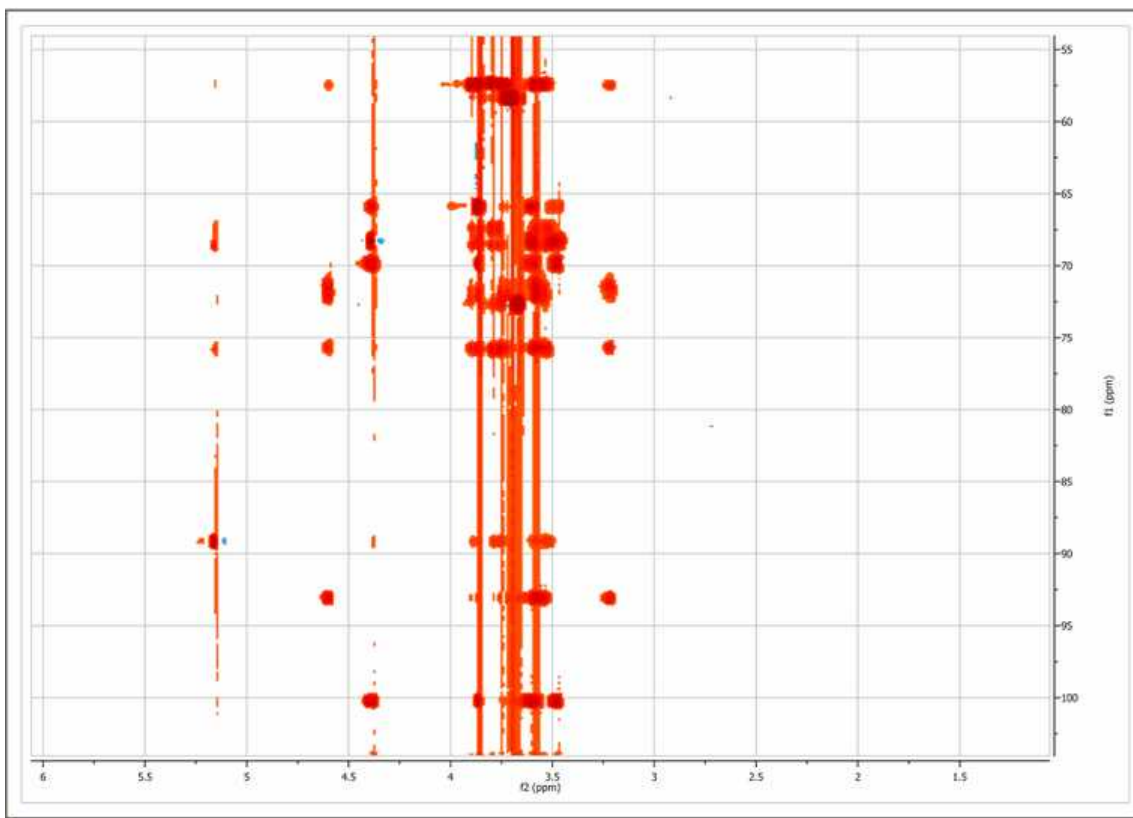

The program has performed the following set of operations on the fly:

1. Automatic file format recognition: The program identifies this file as a Bruker file and uses the corresponding filter to decipher the data
2. For each dimension:
 - [Weighting](#)
 - [Zero filling](#)
 - [Fourier Transform](#)
 - [Phase Correction](#)

Baseline Correction

From the figure above, baseline artifacts along the indirect (f1) dimension are apparent. They can be easily removed by the [baseline correction](#) procedure. Select this option by clicking on the **'Baseline**

Correction' icon  to obtain an automatic **'Baseline Correction'** or by choosing 'Baseline Correction' in the scroll bar menu:

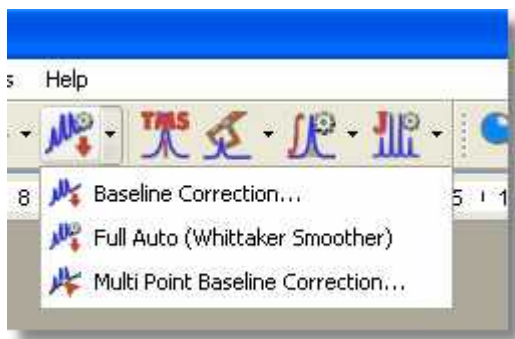

so that you get the following dialog box:

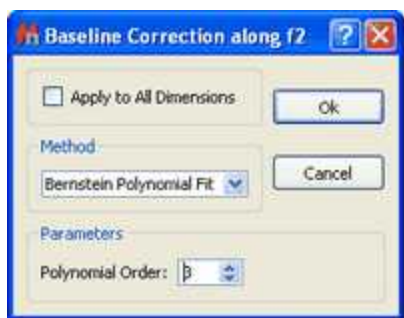

Baseline correction will be applied to the currently **active dimension** unless the **Apply to All Dimensions** option is checked. What does **active dimension** mean? The active dimension is the dimension highlighted on the toolbar and is generally the direct dimension. With the exception of [phase correction](#), processing operations in Mnova default to the active dimension only. For example, if we want to process along columns (f1) you just need to set the processing dimension to f1 as depicted below:

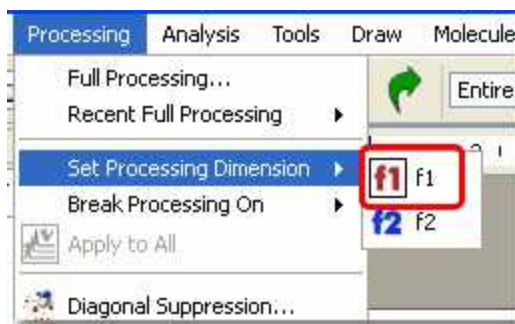

As a shortcut, you can use the corresponding toolbar buttons:



In our present situation, as the current processing dimension is **f2**, baseline correction will take place only along this dimension. This is not appropriate for our case as it is evident that baseline distortions are present mainly along the indirect (**f1**) dimension. We can simply set the processing dimension to **f1**, but it is even simpler to check the **Apply to All Dimensions** option in the **baseline correction dialog box**. After applying the correction using default values, this is the resulting spectrum:

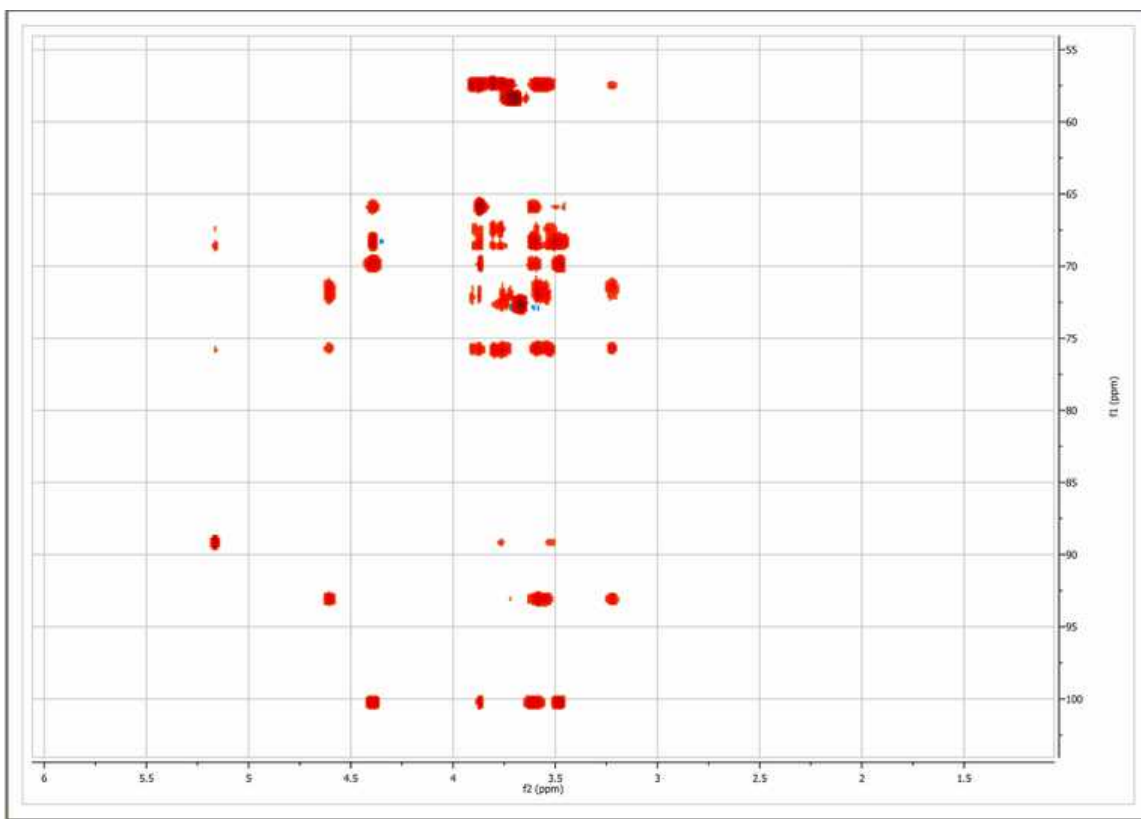

The user can show the traces of the 2D-NMR spectrum, just by clicking on '**Show Traces**' icon . In the same icon, you will find a scroll bar menu to setup the vertical and horizontal traces of a bidimensional spectrum. It will be also possible to show the traces by default, just by selecting this option on the 'Properties dialog box and clicking on the 'Set as default' button.

See also ['Show traces in 2D-NMR'](#)

More on real time frequency domain processing

In the [1D NMR Processing](#) section, we described the real-time frequency domain processing concept. **Diagonal Suppression** of homonuclear 2D experiments represents another example of this concept. This technique is typically carried out in the mixed time-frequency domain (interferogram). However, this is something you do not need to know in Mnova. You can suppress the diagonal while the transformed spectrum is on the screen.

For example, the figure below shows a 2D magnitude spectrum:

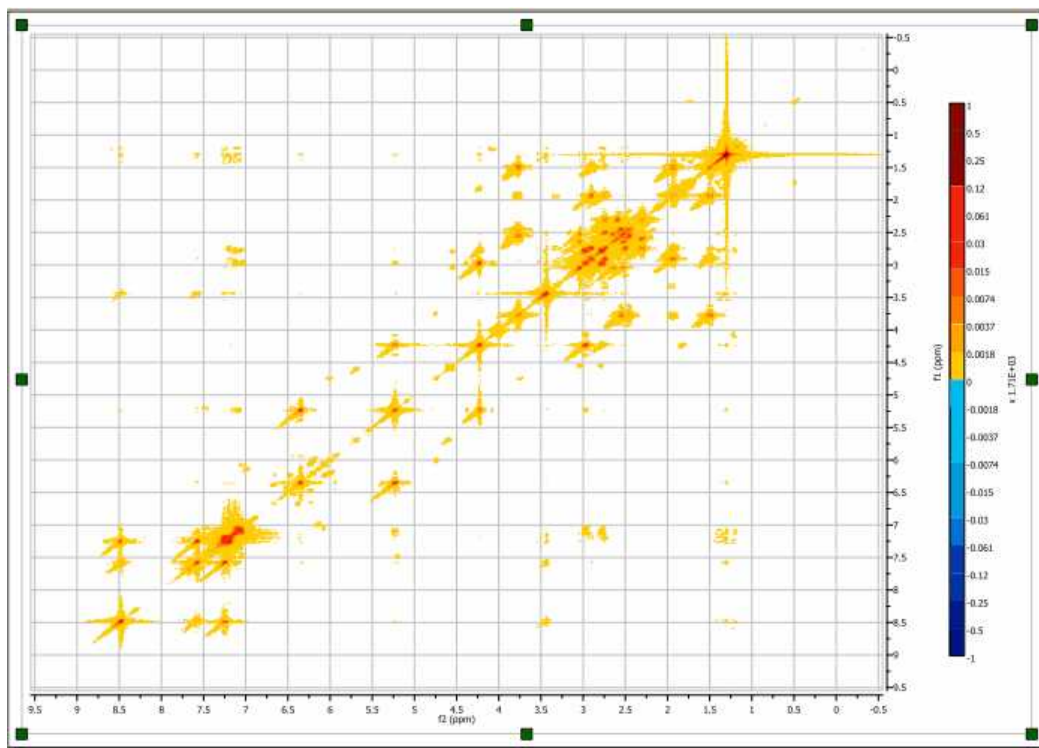

To suppress the diagonal, just click on the small arrow at the right-hand side of the FT toolbar button (see below) and select the **Diagonal Suppression** command:

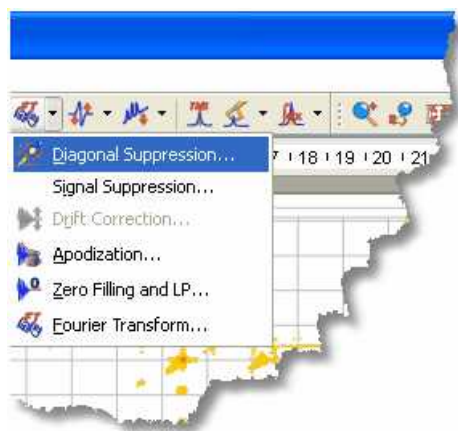

Mnova provides different algorithms for this task. In this example we will select the Wavelet method



And this is the resulting diagonal-free spectrum.

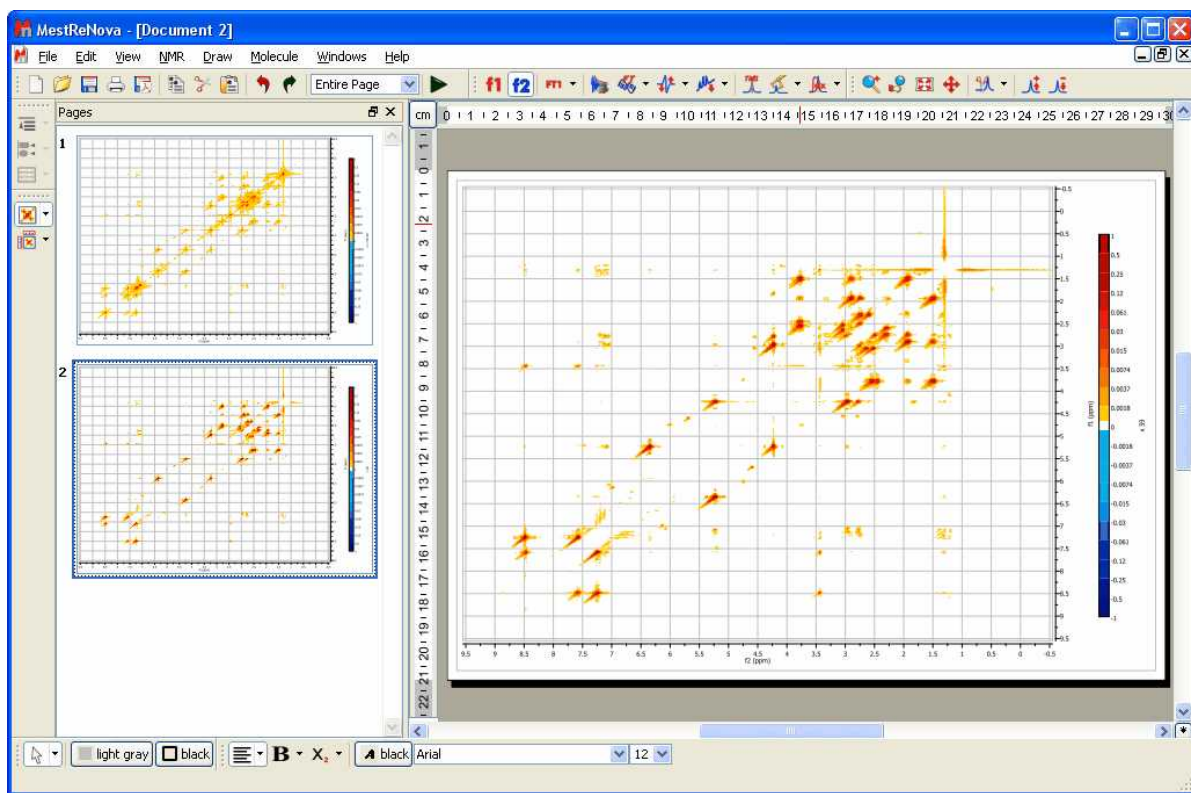

Note that in the figure above there are two pages, the first one containing the 2D spectrum with its original diagonal, and the second one after the diagonal has been removed.

See also

[Phase Correction](#)
[Baseline Correction](#)

8.3 Stacked NMR Processing

Many types of experiments require obtaining a series of FIDs, related to each other through the variation of one or more parameters (temperature, concentration, solvent...). The user, for example, may need to run several spectra at different temperatures: 270K, 300K, 330K, 360K and 390K. Instead of acquiring five different sets of data, the user is able to create an array in which the temp parameter is given for successively different values.

Creating a stacked (or pseudo 2D) spectrum with Mnova is very easy; just by **dragging** one spectrum from the 'Page Navigator' to another spectral window. In the example below we are dragging the first page into the second spectrum to generate a stack plot:

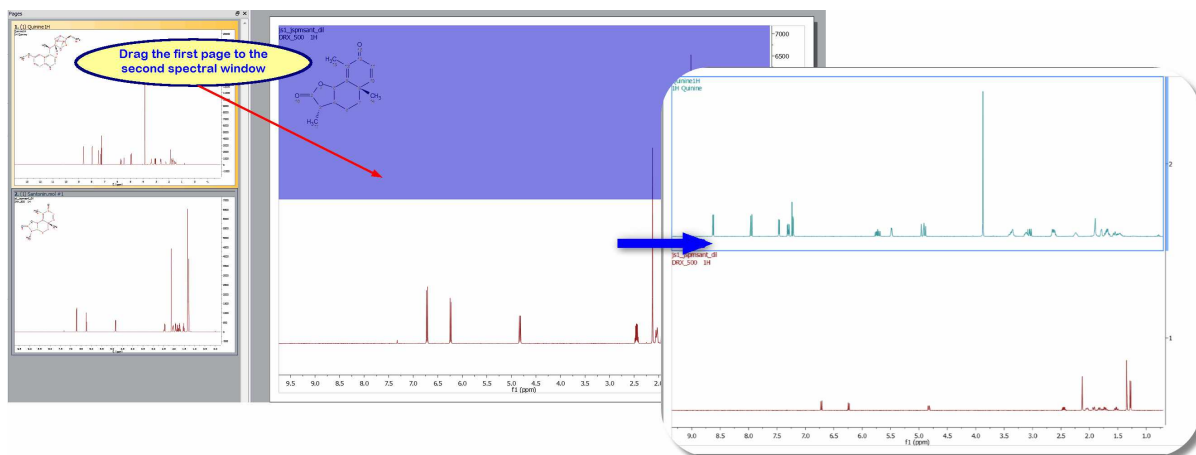

It will be also possible to use this method to add a spectrum to an existing stack. In the example below we are adding the spectrum in the second page as the trace 19th of the stacked plot:

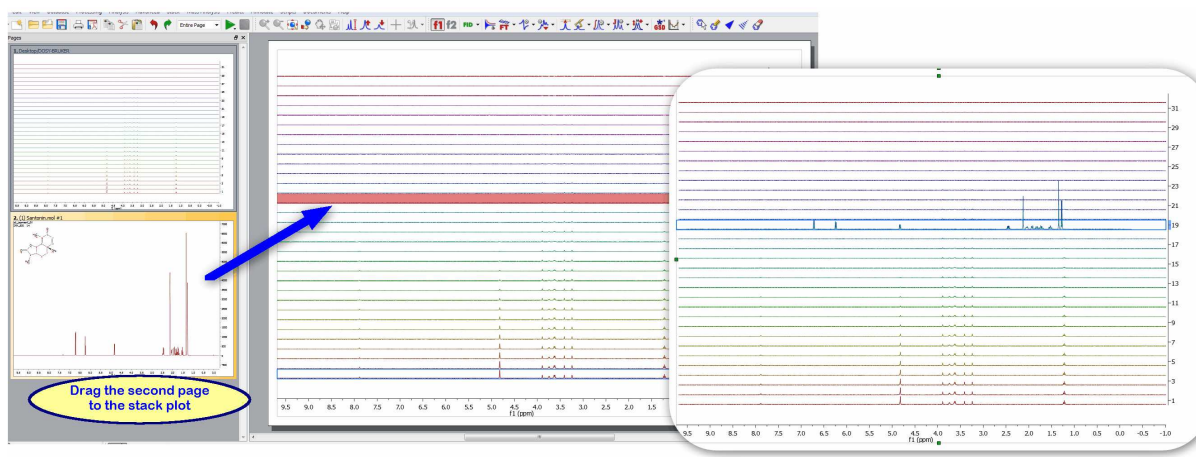

You can also create a stack plot by selecting the desired spectra in the page navigator (by holding down 'CTRL/Cmd key' while clicking on each spectrum) and then issue the command 'Stack/Stack Spectra' (or by pressing the applicable button in the left-vertical toolbar):

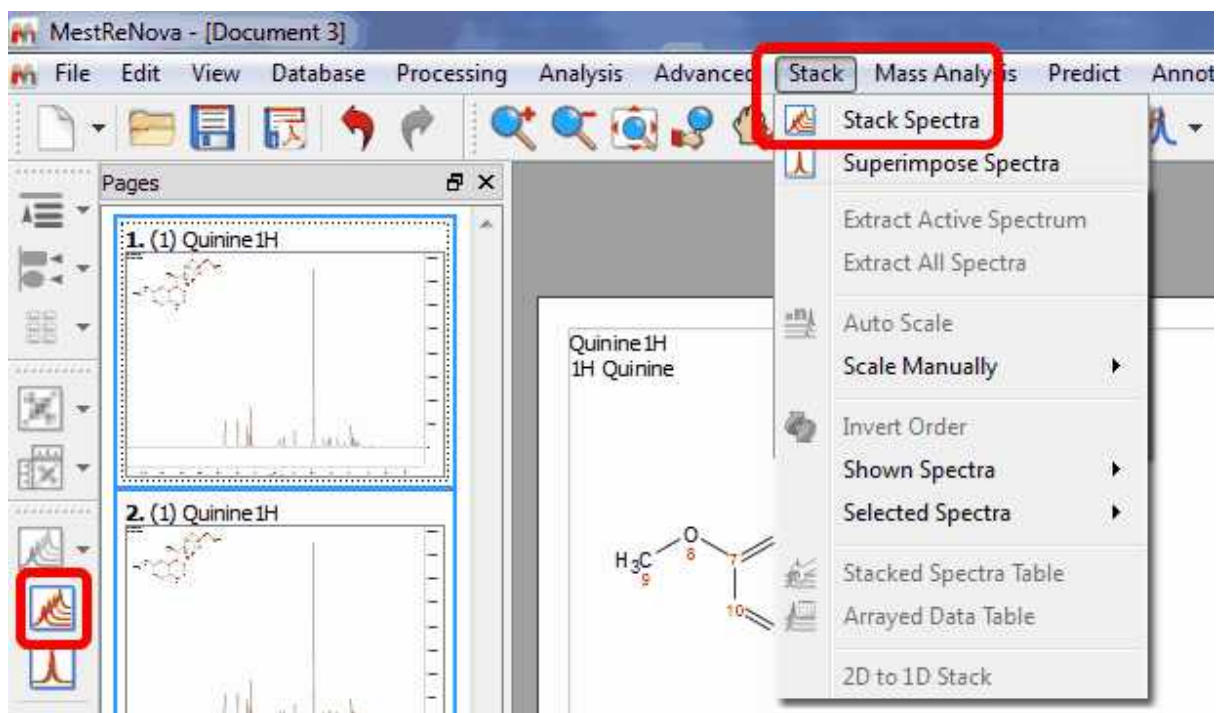

By default Mnova will not delete the 1D spectra after having stacked them. If you want to modify this default, you will need to follow the menu 'Stack/Stack Options' and uncheck the applicable box.

Additionally, Mnova can detect spectra which have been acquired in the so-called arrayed-mode (or pseudo 2D), typically used in relaxation, kinetics or diffusion experiments. For all these cases, Mnova will only process the acquired dimension (t2). Basically, Mnova will process only the rows of the data matrix and, by default, will display the spectrum as a stacked plot (see below):

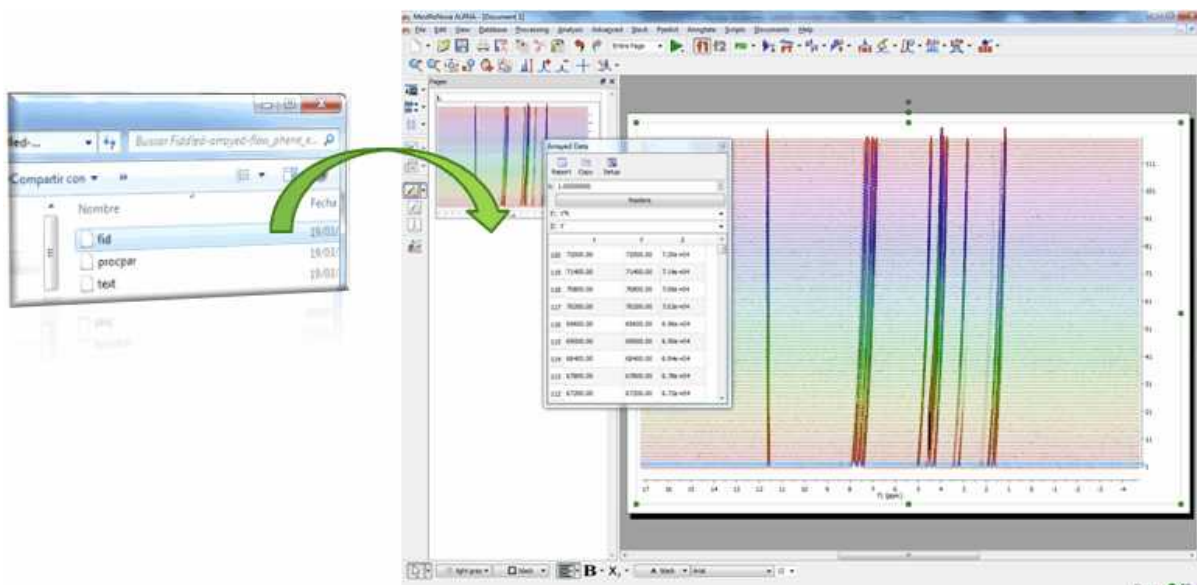



A few tips on Stacked Spectra

- You will be able to change the stacked angle to zero (15° by default) in the properties dialog box (by double clicking on the spectral window).
- You can normalize the spectra (if they have different intensities) by using the command: 'Processing/Normalize'.
- It is possible to highlight the desired trace of the stack plot just by clicking on it.
- It is possible to create a stack spectrum just by dragging one spectrum to another.

Display Modes:

The user can select the stacked NMR representation mode by clicking on the scroll menu belonging to the **'Stacked NMR'** icon :

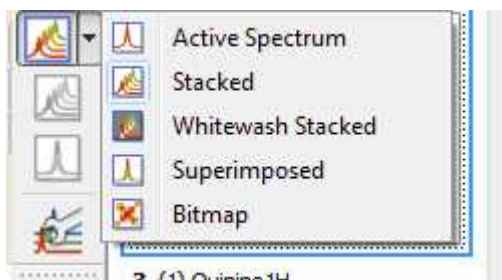

In this scroll bar menu you will also find:

'Active Spectrum': to see only the highlighted spectrum.

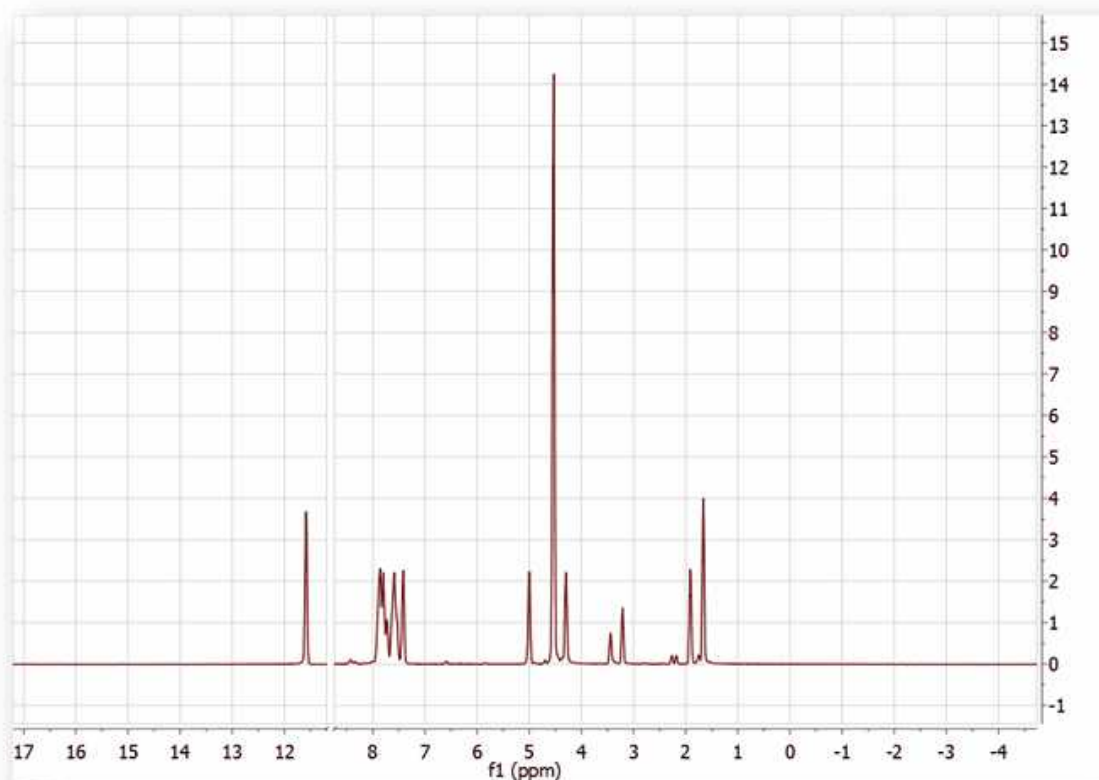

'Stacked': to see all the spectra in arrayed mode.

Stacked Angle = 0°

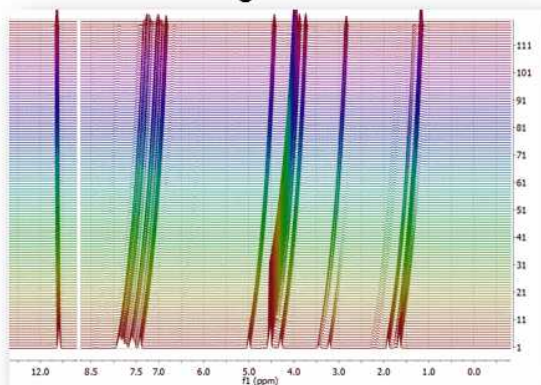

Stacked Angle = 25°

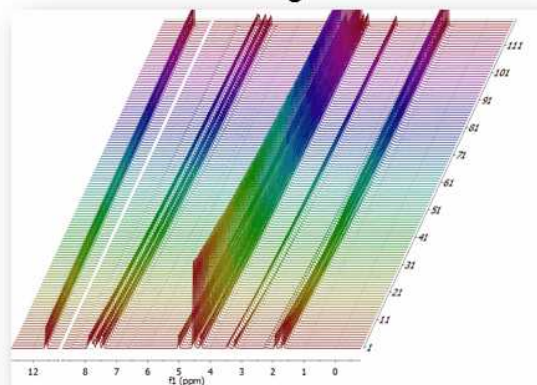

'Superimposed': to see all the spectra overlaid (one over another).

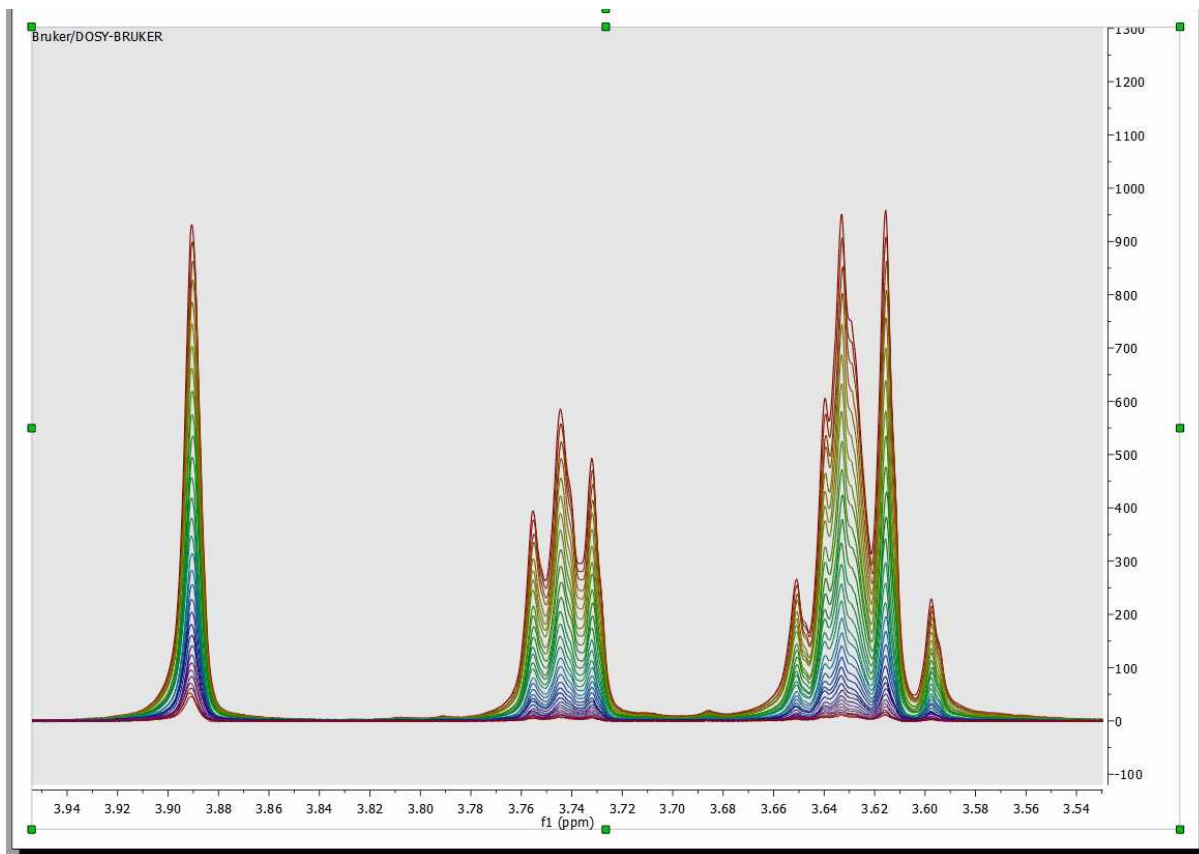

'Bitmap': too see all spectra in a bitmap mode.

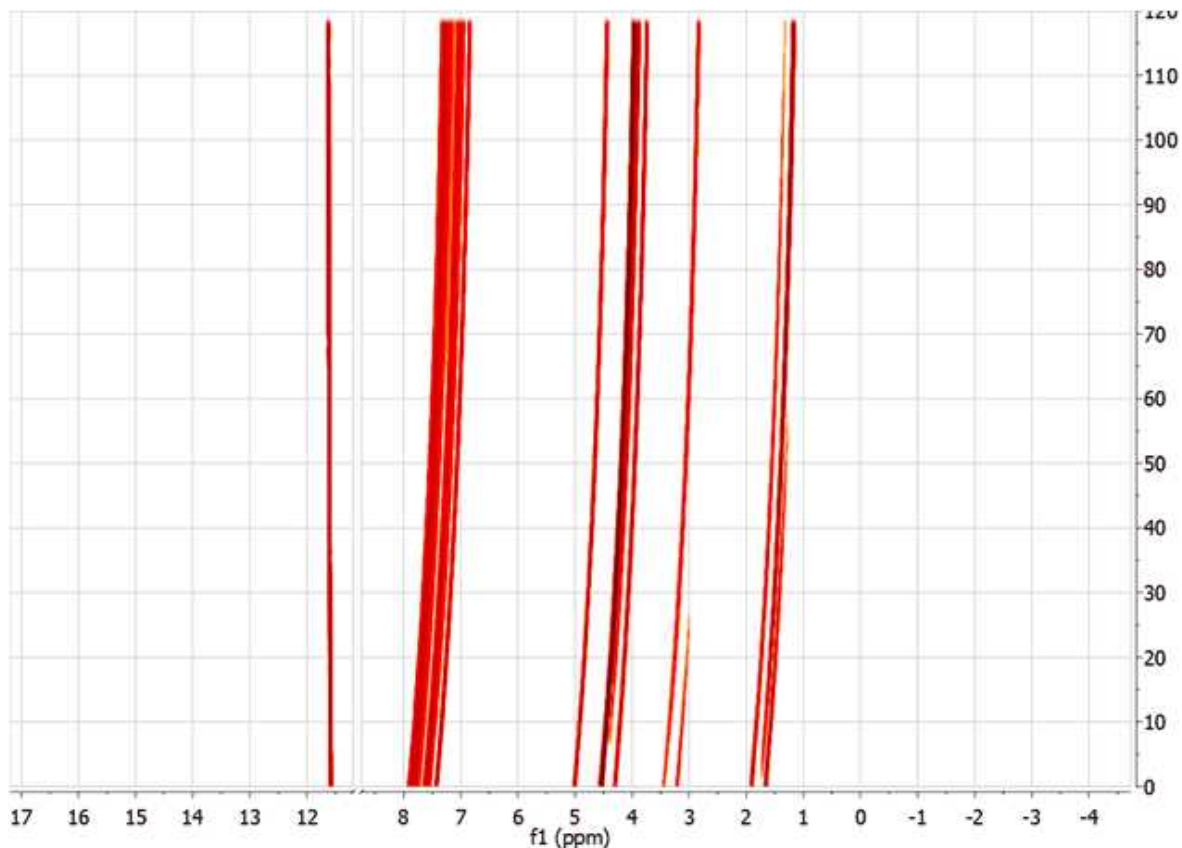

See also: [Stacked table](#) and [Handling Arrayed Spectra](#)

Multiple spectral selection:

Mnova includes a powerful, yet easy to use **multiple spectral selection** mode, which allows the user to optimize the processing of groups of spectra by selecting a bunch of spectra and applying any processing (e.g. manual phase correction to the selected group)

Multiple spectra selection can be done either **graphically** from the stack or directly from a **table**.

In addition, Mnova now offers the ability to hide any number of spectra in an arrayed item.

Graphical selection of spectra

In order to be able to select a bunch of spectra **graphically** with the mouse, it is necessary to display the spectra in the stacked plot mode

To select a single spectrum, **left click** on the spectrum trace while keeping pressed the **Alt key**
 To deselect a spectrum: **left click + Ctrl + Alt**

In order to select multiple spectra, follow the same operation as above while keeping pressed **Ctrl and/or Shift keys**.

Some Important concepts: Active spectrum vs Selected spectrum/spectra

Selected spectra: when the spectra are selected, they are highlighted with a light blue background. Any processing operation will take place only for those selected spectra. (To select a single spectrum, left click on the spectrum trace while keeping pressed the Alt key. To deselect a spectrum: left click +

Ctrl + Alt)

In order to select multiple spectra, follow the same operation as above while keeping pressed Ctrl and/or Shift keys.

Active Spectrum: active spectrum is marked with a blue box and it indicates the spectrum which will be displayed in the *active spectrum* display mode. It's also the reference spectrum used in some processing operations (e.g. alignment). You can select the active spectrum by clicking on the trace in the stack plot and also by double clicking on the applicable row of the Stacked Spectra table.

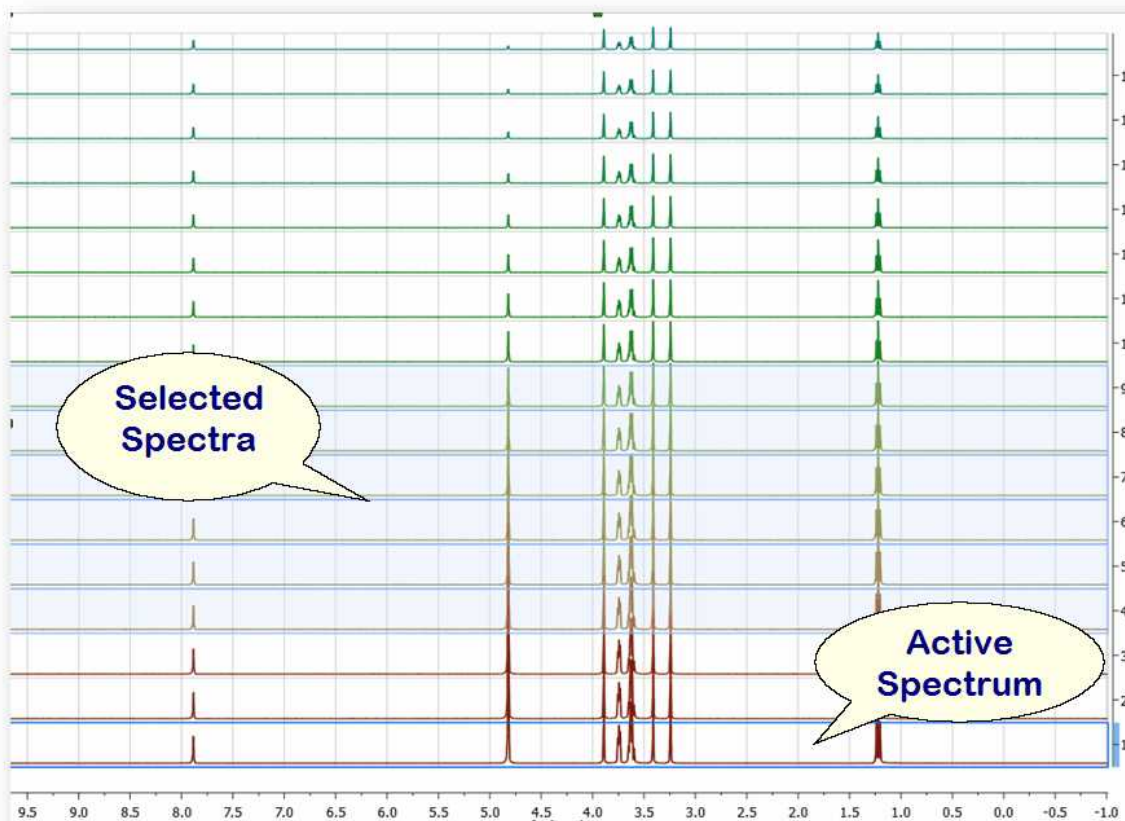

You can also **select** several slides by using the check boxes on the right of the 'Stacked Spectra Table'. When the spectra are selected, they are highlighted with a light blue background. Any processing operation will take place only for those selected spectra.

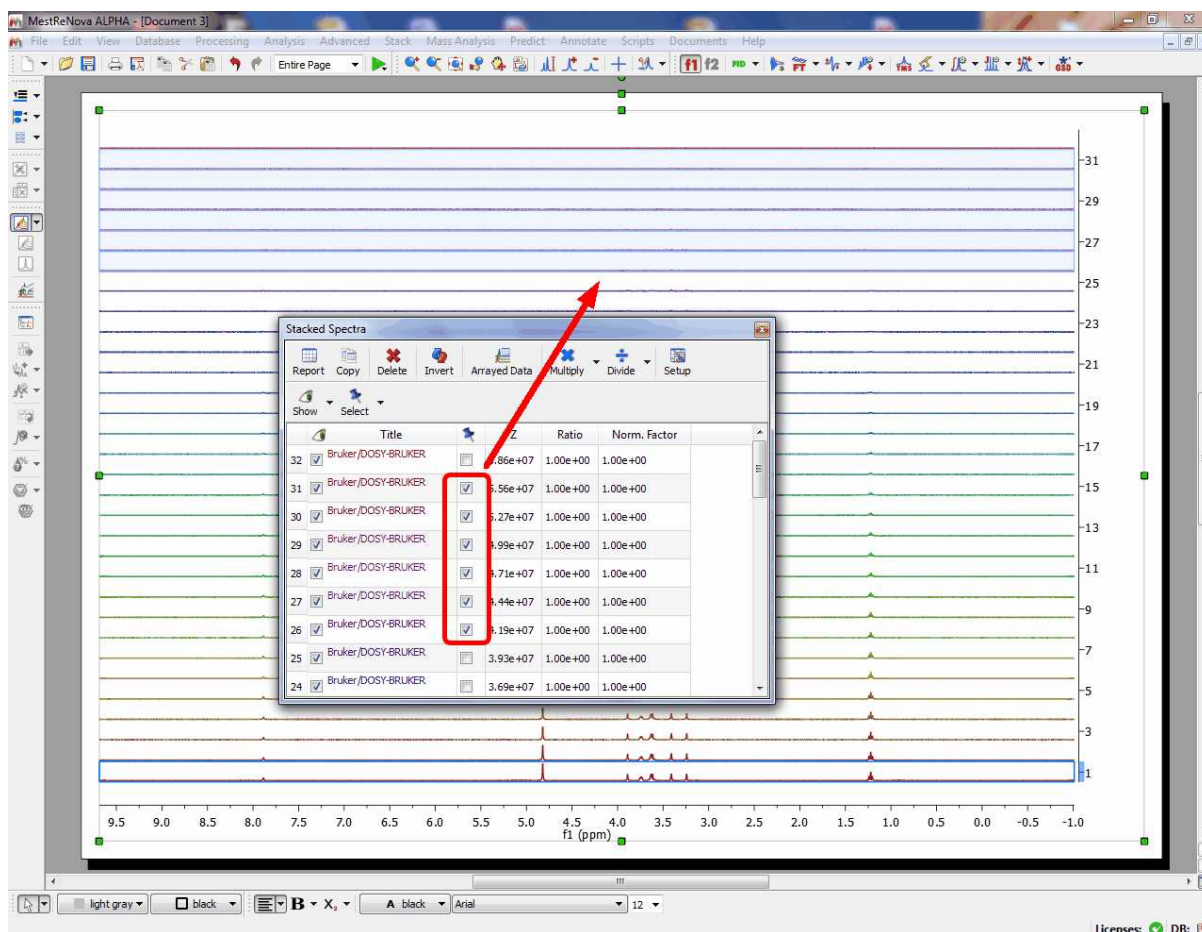

To navigate through the traces in the stack plot, press and hold down **SHIFT** and use the up or down arrow key (or use the mouse scroll wheel). The **active trace** will be highlighted by default with a blue rectangle, whilst **selected traces** will be highlighted with a light blue background (those marks will not be exported with the stack plot). Any processing operation will take place only for those selected spectra.

Please note that in strange cases, Mnova shows some arrayed datasets as 2D plots. In those cases just follow the menu 'Stack/2D to 1D stack':

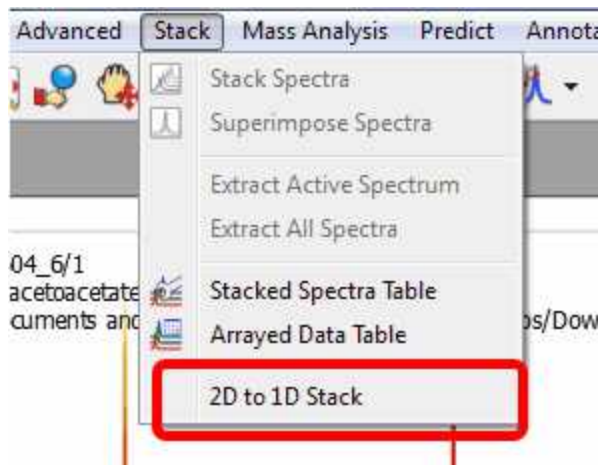

8.3.1 How to apply a peak picking or an integration analysis in stacked mode?

How to apply a peak picking or an integration analysis in stacked mode?

It is very easy to apply a peak picking or an integration analysis to a stacked spectra, just by clicking on the corresponding icon (or selecting the desired analysis function). In the picture below, we have applied an automatic peak picking and a manual integration of several areas of interest:

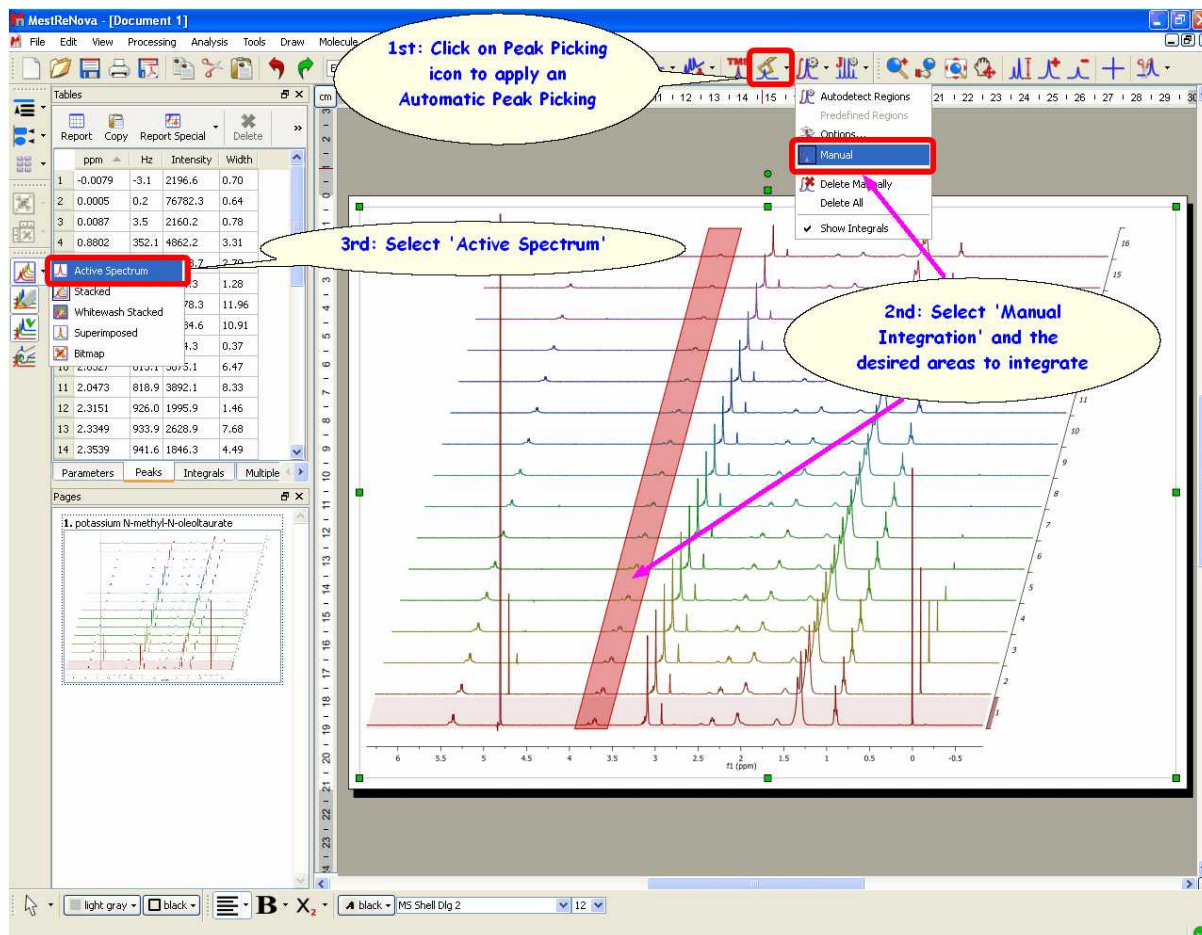

Then, just select 'Active Spectrum' in the vertical toolbar to obtain only the highlighted spectrum and you will be able to see the integrals and the peak picking. To navigate through the traces, press and hold down **SHIFT** and use the up or down arrow keys (or the mouse scroll wheel):

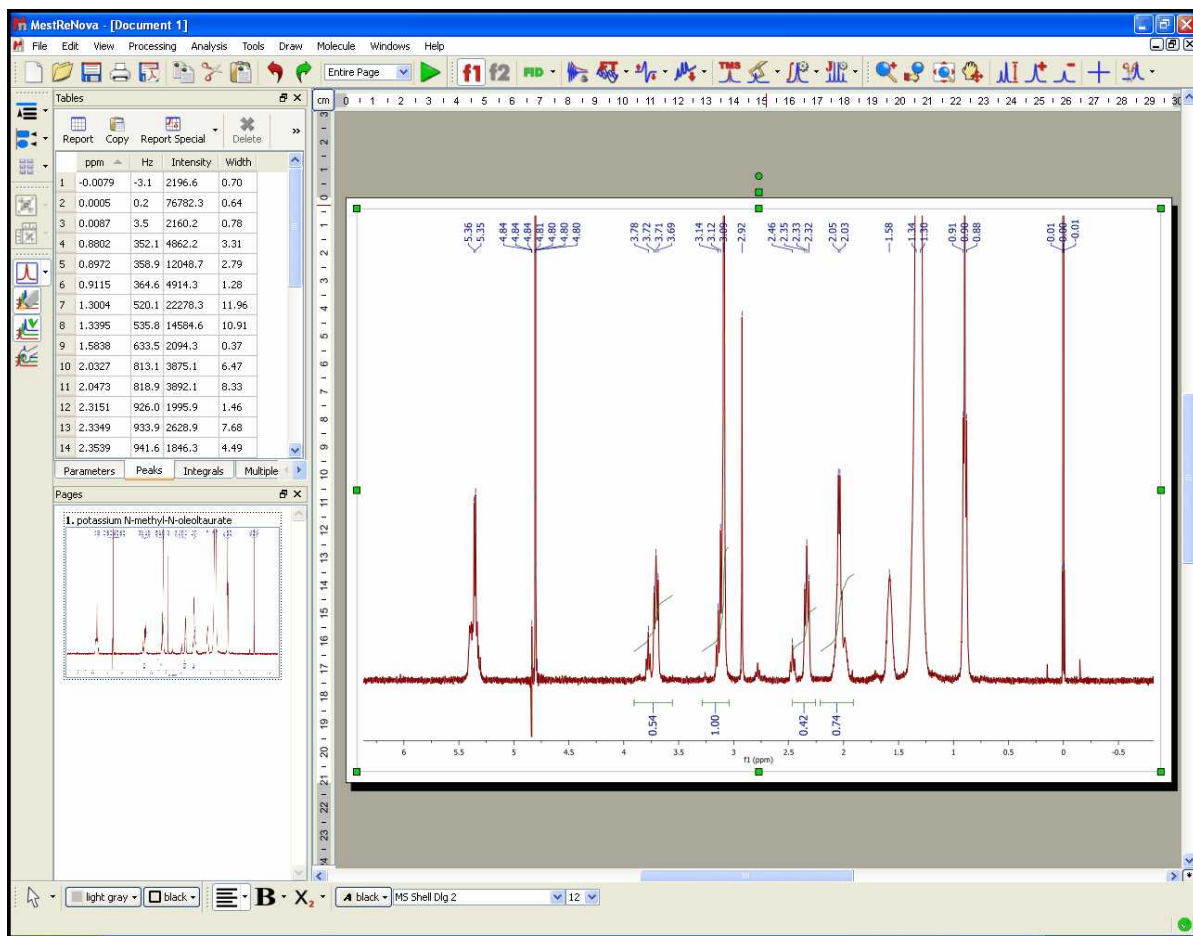

Finally you can export the peak picking or the integration analysis to a text file by following the menu File/Save as/Script:ASCII Matrix or 1D Integral Series (*.txt). This will generate a text file which can be loaded into Excel (for example). Saving as "Script: NMR CSV Matrix (.txt)" you will get the zoomed area of all spectra distributed in columns (blind region and cut areas will be filled with zeroes). If you save it as "Script: NMR CSV Matrix (Transposed) (.txt)" you will get them in rows.

It will be possible (from the Integral Manager) to apply the same integral normalization to all the spectra (in the current document) or to all the traces of a stack plot by selecting the applicable option, as you can see below. This is very useful if you need for example to determine relaxation times from a series of 1D spectra, to be able to compare the integral values between the different traces.

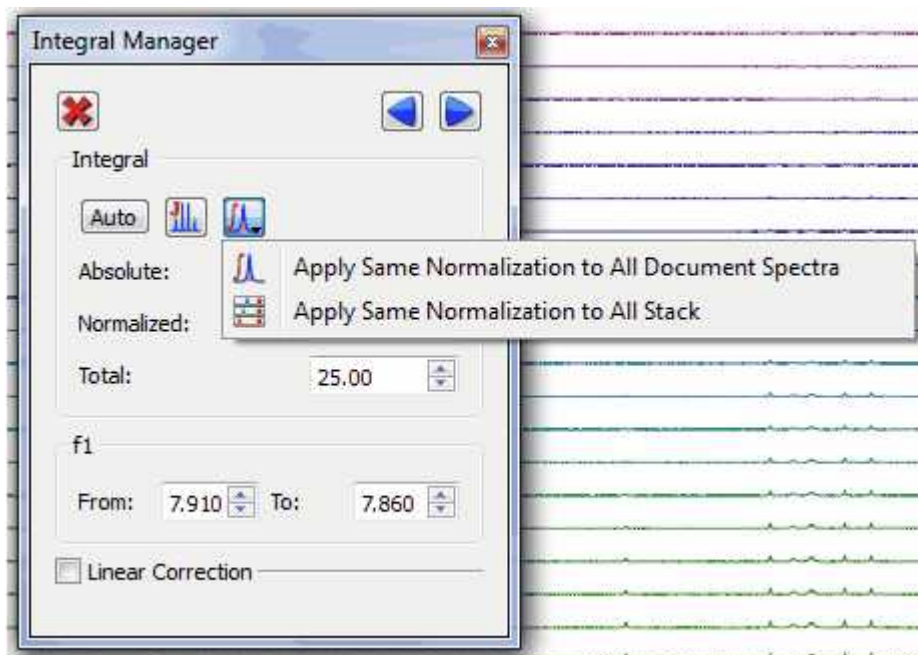

8.3.2 Table of stacked spectra

This table makes it possible to select spectra as an alternative way to the graphical method but it offers more features, including the ability to **delete**, **hide** or **change the relative intensities** of any spectra:

	Title	Z	Ratio	Iorm. Facto
190	66353Lilly/190	6.64e+04	1.00e+00	1.00e+00
189	66002Lilly/189	6.60e+04	1.00e+00	1.00e+00
188	65650Lilly/188	6.56e+04	1.00e+00	1.00e+00
187	65296Lilly/187	6.53e+04	1.00e+00	1.00e+00
186	64945Lilly/186	6.49e+04	1.00e+00	1.00e+00
185	64593Lilly/185	6.46e+04	1.00e+00	1.00e+00
184	64241Lilly/184	6.42e+04	1.00e+00	1.00e+00
183	63890Lilly/183	6.39e+04	1.00e+00	1.00e+00
182	63538Lilly/182	6.35e+04	1.00e+00	1.00e+00
181	63187Lilly/181	6.32e+04	1.00e+00	1.00e+00
180	62835Lilly/180	6.28e+04	1.00e+00	1.00e+00

Sorting traces:

The user can easily **sort** the traces of the arrayed spectrum by clicking on the '**Stacked Spectra Table**' icon  to display the dialog box below:

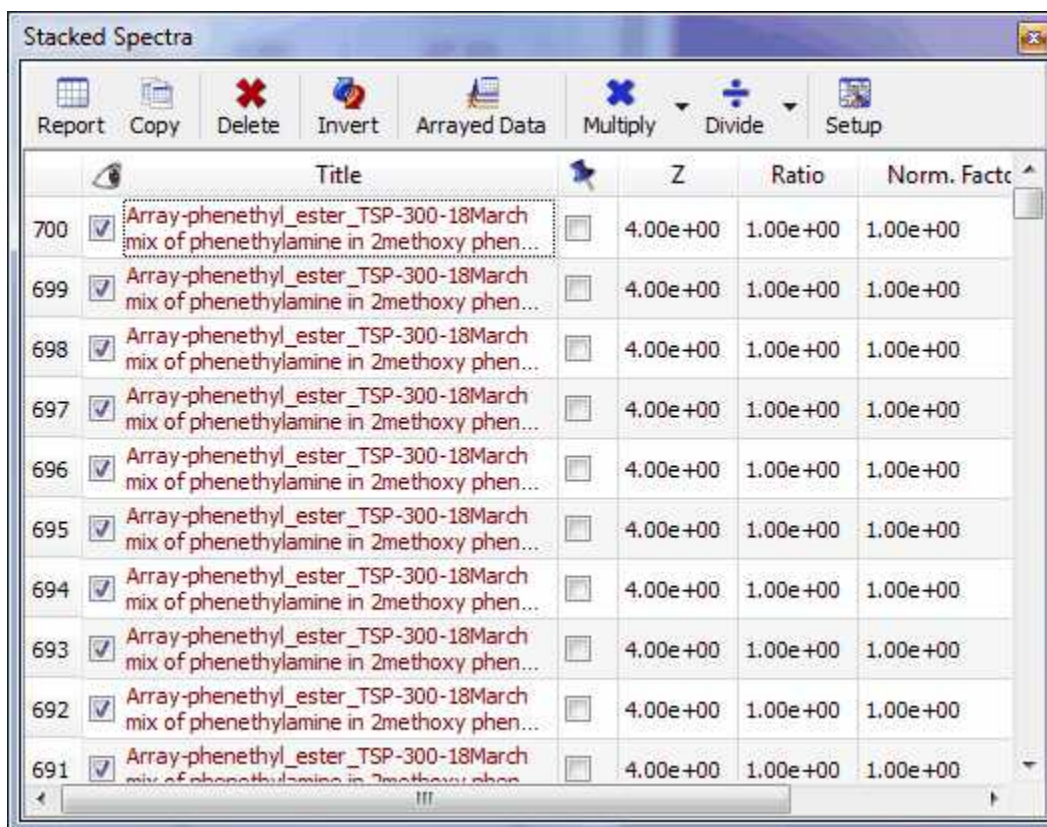

		Title		Z	Ratio	Norm. Fact
700	<input checked="" type="checkbox"/>	Array-phenethyl_ester_TSP-300-18March mix of phenethylamine in 2methoxy phen...	<input type="checkbox"/>	4.00e+00	1.00e+00	1.00e+00
699	<input checked="" type="checkbox"/>	Array-phenethyl_ester_TSP-300-18March mix of phenethylamine in 2methoxy phen...	<input type="checkbox"/>	4.00e+00	1.00e+00	1.00e+00
698	<input checked="" type="checkbox"/>	Array-phenethyl_ester_TSP-300-18March mix of phenethylamine in 2methoxy phen...	<input type="checkbox"/>	4.00e+00	1.00e+00	1.00e+00
697	<input checked="" type="checkbox"/>	Array-phenethyl_ester_TSP-300-18March mix of phenethylamine in 2methoxy phen...	<input type="checkbox"/>	4.00e+00	1.00e+00	1.00e+00
696	<input checked="" type="checkbox"/>	Array-phenethyl_ester_TSP-300-18March mix of phenethylamine in 2methoxy phen...	<input type="checkbox"/>	4.00e+00	1.00e+00	1.00e+00
695	<input checked="" type="checkbox"/>	Array-phenethyl_ester_TSP-300-18March mix of phenethylamine in 2methoxy phen...	<input type="checkbox"/>	4.00e+00	1.00e+00	1.00e+00
694	<input checked="" type="checkbox"/>	Array-phenethyl_ester_TSP-300-18March mix of phenethylamine in 2methoxy phen...	<input type="checkbox"/>	4.00e+00	1.00e+00	1.00e+00
693	<input checked="" type="checkbox"/>	Array-phenethyl_ester_TSP-300-18March mix of phenethylamine in 2methoxy phen...	<input type="checkbox"/>	4.00e+00	1.00e+00	1.00e+00
692	<input checked="" type="checkbox"/>	Array-phenethyl_ester_TSP-300-18March mix of phenethylamine in 2methoxy phen...	<input type="checkbox"/>	4.00e+00	1.00e+00	1.00e+00
691	<input checked="" type="checkbox"/>	Array-phenethyl_ester_TSP-300-18March mix of phenethylamine in 2methoxy phen...	<input type="checkbox"/>	4.00e+00	1.00e+00	1.00e+00

Once there, **click on the number of the spectrum** for which you want to change the location and drag to the desired location. Clicking on the title header will sort the spectra in descending/ascending order by title.

How to hide several spectra?

It is really easy to hide slides, just:

- Select in the table all those rows corresponding to the spectra you want to hide

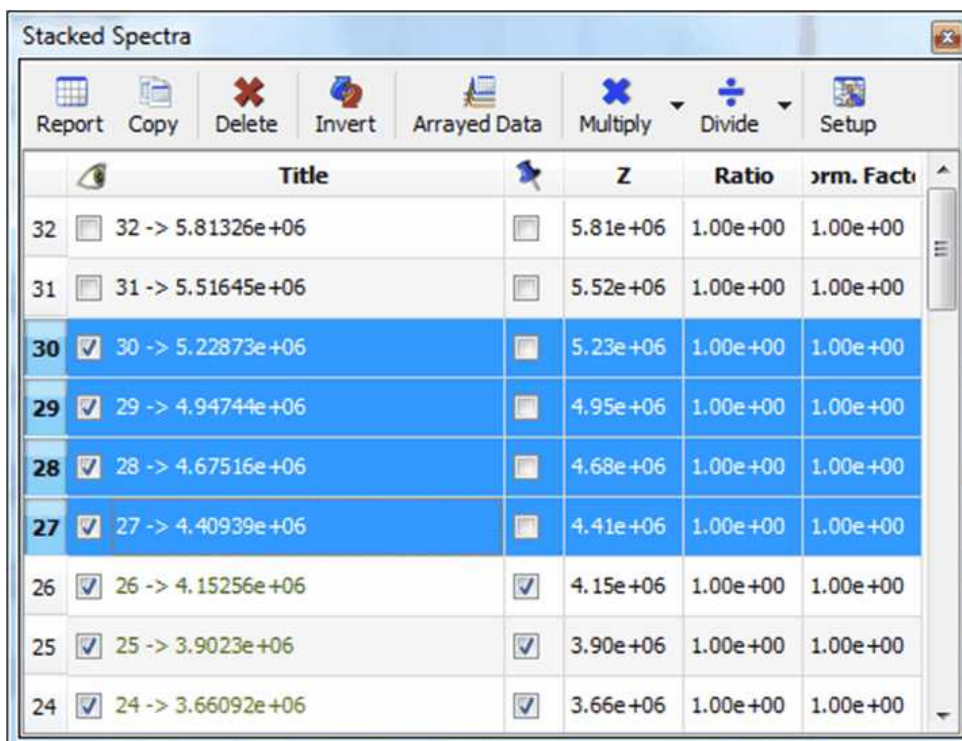

		Title		Z	Ratio	Norm. Fact
32	<input type="checkbox"/>	32 -> 5.81326e+06	<input type="checkbox"/>	5.81e+06	1.00e+00	1.00e+00
31	<input type="checkbox"/>	31 -> 5.51645e+06	<input type="checkbox"/>	5.52e+06	1.00e+00	1.00e+00
30	<input checked="" type="checkbox"/>	30 -> 5.22873e+06	<input type="checkbox"/>	5.23e+06	1.00e+00	1.00e+00
29	<input checked="" type="checkbox"/>	29 -> 4.94744e+06	<input type="checkbox"/>	4.95e+06	1.00e+00	1.00e+00
28	<input checked="" type="checkbox"/>	28 -> 4.67516e+06	<input type="checkbox"/>	4.68e+06	1.00e+00	1.00e+00
27	<input checked="" type="checkbox"/>	27 -> 4.40939e+06	<input type="checkbox"/>	4.41e+06	1.00e+00	1.00e+00
26	<input checked="" type="checkbox"/>	26 -> 4.15256e+06	<input checked="" type="checkbox"/>	4.15e+06	1.00e+00	1.00e+00
25	<input checked="" type="checkbox"/>	25 -> 3.9023e+06	<input checked="" type="checkbox"/>	3.90e+06	1.00e+00	1.00e+00
24	<input checked="" type="checkbox"/>	24 -> 3.66092e+06	<input checked="" type="checkbox"/>	3.66e+06	1.00e+00	1.00e+00

- and uncheck the boxes of selected rows:

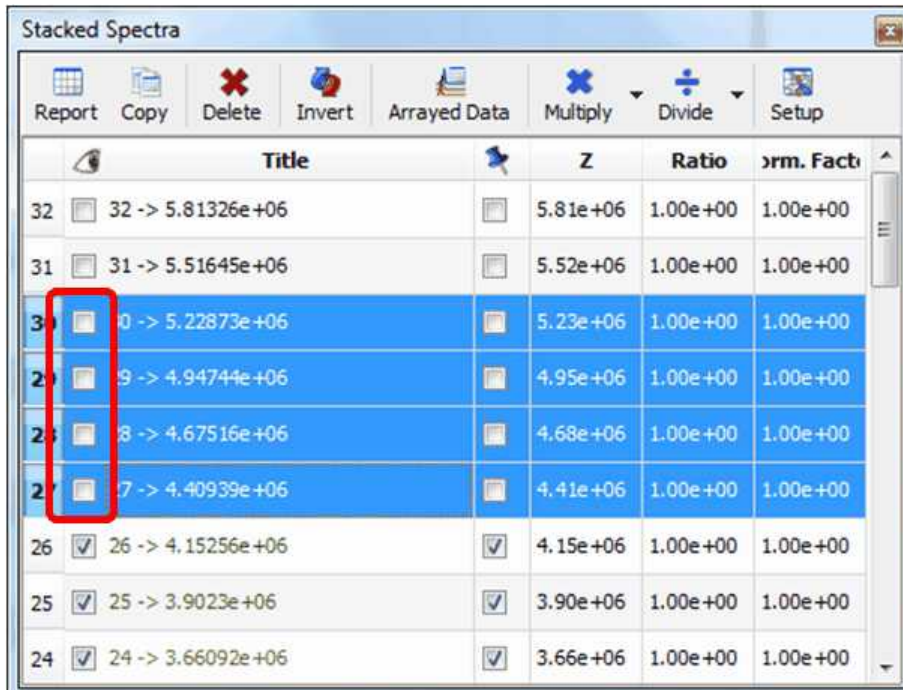

		Title		Z	Ratio	Norm. Fact
32	<input type="checkbox"/>	32 -> 5.81326e+06	<input type="checkbox"/>	5.81e+06	1.00e+00	1.00e+00
31	<input type="checkbox"/>	31 -> 5.51645e+06	<input type="checkbox"/>	5.52e+06	1.00e+00	1.00e+00
30	<input type="checkbox"/>	30 -> 5.22873e+06	<input type="checkbox"/>	5.23e+06	1.00e+00	1.00e+00
29	<input type="checkbox"/>	29 -> 4.94744e+06	<input type="checkbox"/>	4.95e+06	1.00e+00	1.00e+00
28	<input type="checkbox"/>	28 -> 4.67516e+06	<input type="checkbox"/>	4.68e+06	1.00e+00	1.00e+00
27	<input type="checkbox"/>	27 -> 4.40939e+06	<input type="checkbox"/>	4.41e+06	1.00e+00	1.00e+00
26	<input checked="" type="checkbox"/>	26 -> 4.15256e+06	<input checked="" type="checkbox"/>	4.15e+06	1.00e+00	1.00e+00
25	<input checked="" type="checkbox"/>	25 -> 3.9023e+06	<input checked="" type="checkbox"/>	3.90e+06	1.00e+00	1.00e+00
24	<input checked="" type="checkbox"/>	24 -> 3.66092e+06	<input checked="" type="checkbox"/>	3.66e+06	1.00e+00	1.00e+00

You can follow the same operations to restore those spectra.

This table provides new options to easily hide or select any number of spectra

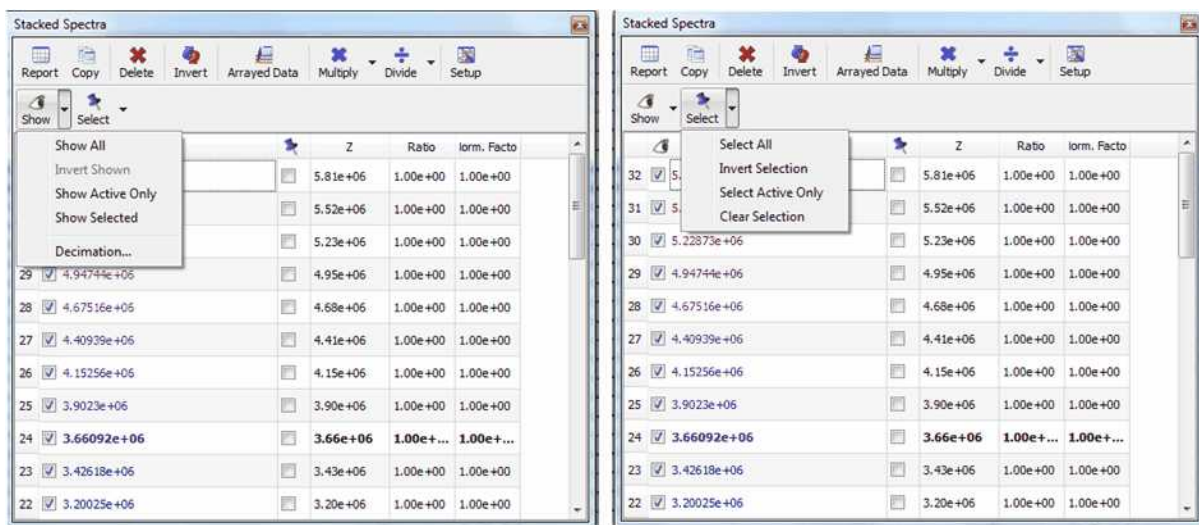

How to scale the traces of the stacked spectra?

The user can also change the intensity of the traces from the 'Setup Stacked' dialog box; which can be displayed by clicking on the applicable icon of the toolbar  (or by following the menu 'Stack/Setup Stacked Spectra'). Once there, just check the box of the trace that you want to modify and click on the 'Multiply' or 'Divide' buttons of the dialog box (as it is shown in the picture below).

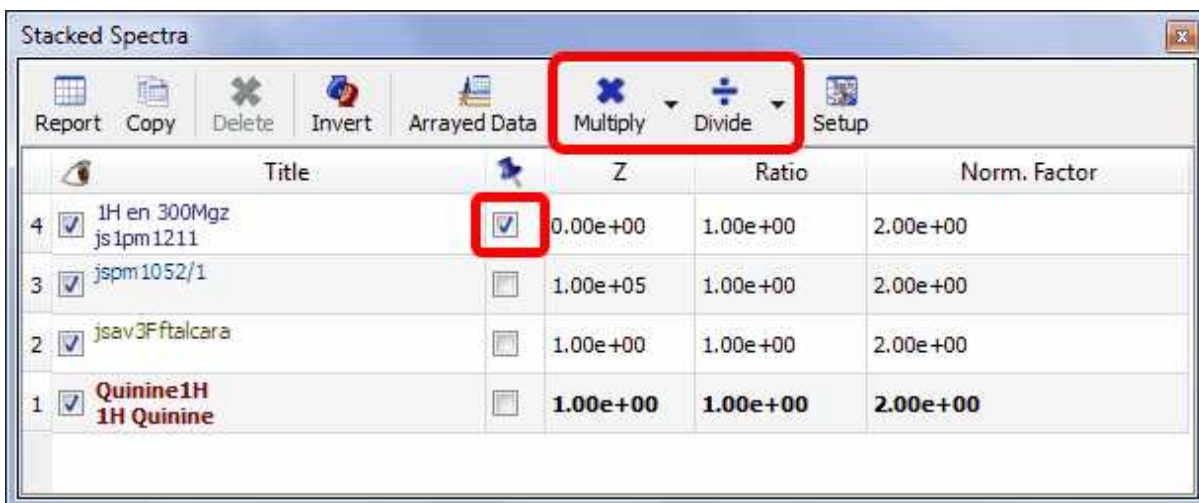

It will be possible to select the factor value just by clicking on the scroll down menu of the multiply or divide buttons.

Please bear in mind that you can also use the buttons of the Stacked NMR toolbar to multiply/divide the intensity of your traces (or follow the menu 'Stack/Scale Manually'):

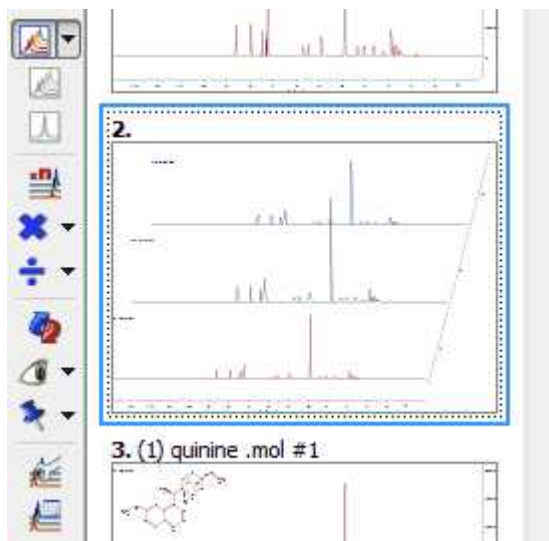

You can also 'Auto Scale' the traces of your spectrum, just by clicking on this button  or by following the menu 'Stack/Auto Scale'.

The user is also able to extract the 'Active Spectrum' or 'All Spectra' together by following the 'Stack menu':

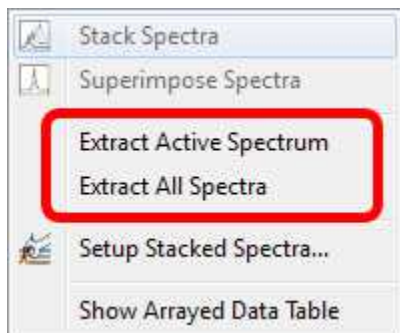

Decimation

Worth mentioning is the '*Decimation*' option:

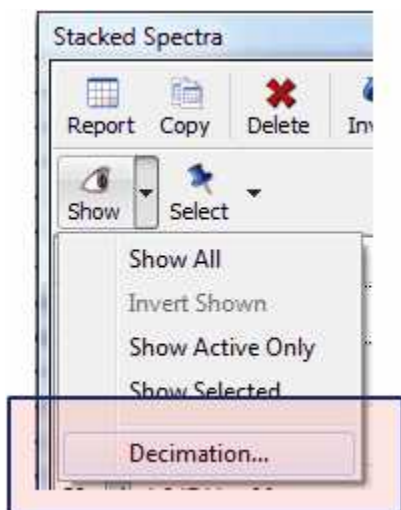

This option is very useful when the number of stacked spectra is very large, slowing down the plotting and not showing relevant information

This shows the result of a R-M experiment consisting of 700 spectra. After selecting **the decimation option**, a new dialog shows up where you can select the first and last spectrum to be displayed and the step or decimation factor. In the picture below you can see how the dataset will look like after decimation:

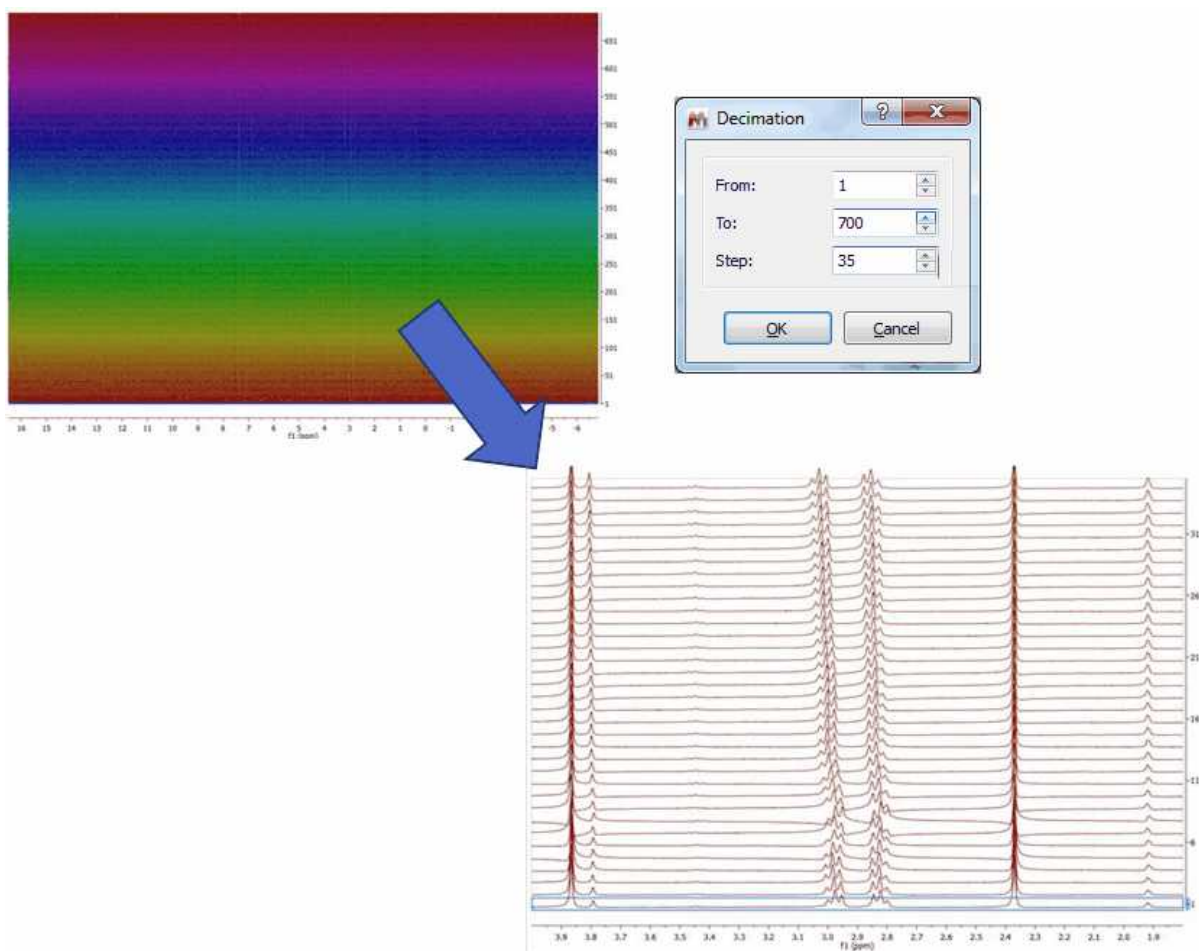

In the context of metabolomics, you would need to classify the stacked spectra by specifying a class. To do that, you can add an editable column to the Stacked Spectra table in order to input there a short text. You can show the 'Class' parameter by clicking on the 'Setup' button of the Stacked Spectra table (or on the Customize button of the 'Parameters Table');

	Title		T/G	Ratio	Norm. Factor	Class
Visible Name	Title		T/G	Ratio	Norm. Factor	Class
Visible	<input checked="" type="checkbox"/>	<input checked="" type="checkbox"/>	<input checked="" type="checkbox"/>	<input checked="" type="checkbox"/>	<input checked="" type="checkbox"/>	<input checked="" type="checkbox"/>
Decimals	0	0	2	2	2	0
Horizontal Alignment	Left	Left	Left	Left	Left	Left

Font... MS Shell Dlg 2

Report

Frame Borders Numbering Title Bold Headers

OK Cancel Apply

This parameter will be editable just with one click (double-click is used to change the active spectrum):

	<input type="checkbox"/>	Title	<input type="checkbox"/>	T/G	Ratio	Norm. Factor	Class
14	<input checked="" type="checkbox"/>	Proton-T1/10 Ref. Sample, T1IR	<input type="checkbox"/>	1.00e+01	1.00e+00	1.00e+00	T2R
13	<input checked="" type="checkbox"/>	Proton-T1/10 Ref. Sample, T1IR	<input checked="" type="checkbox"/>	5.00e+...	1.00e+...	1.00e+00	T2R4
12	<input checked="" type="checkbox"/>	Proton-T1/10 Ref. Sample, T1IR	<input type="checkbox"/>	4.50e+00	1.00e+00	1.00e+00	T2RX
11	<input type="checkbox"/>	Proton-T1/10 Ref. Sample, T1IR	<input type="checkbox"/>	4.00e+00	1.00e+00	1.00e+00	T2RZ
10	<input type="checkbox"/>	Proton-T1/10 Ref. Sample, T1IR	<input type="checkbox"/>	3.50e+00	1.00e+00	1.00e+00	T2R
9	<input type="checkbox"/>	Proton-T1/10 Ref. Sample, T1IR	<input type="checkbox"/>	3.00e+00	1.00e+00	1.00e+00	T2R1

8.3.3 Stacked Options and Properties

Options

By default Mnova will delete the 1D spectra after having stacked them without autoscaling them. If you want to modify these defaults, you will need to follow the menu 'Stack/Stack Options' and uncheck the applicable box. From here, you will be able to change also the stacked angle and to select different palettes for your superimposed 2D experiments.

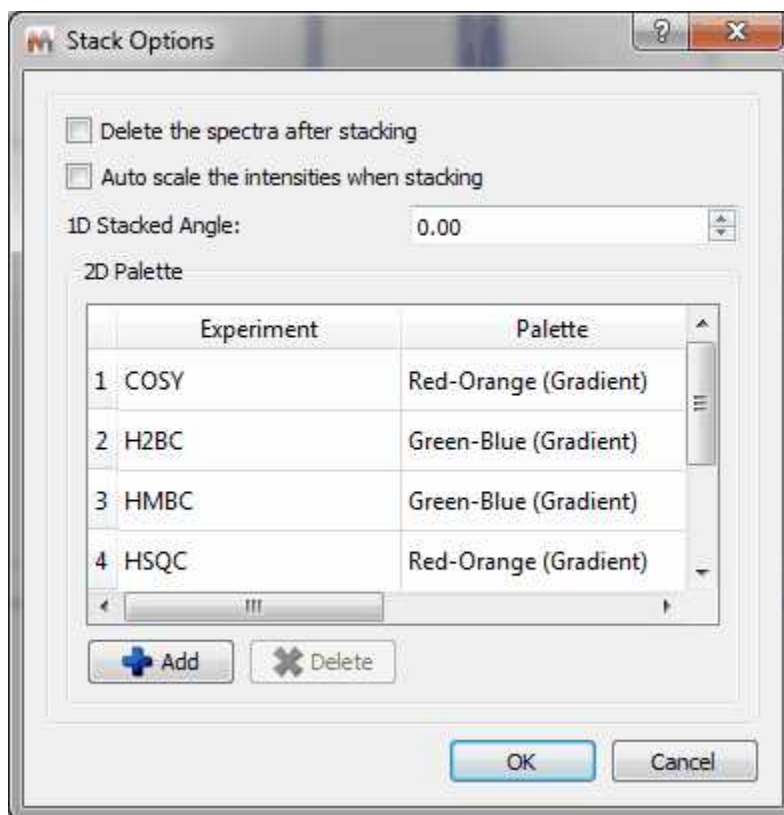

Properties

The user can change the stacked spectra properties by double clicking on the spectrum window; this will display the Properties dialog box, where the user can modify the Style (lines, crosses or circles), the Line Width, the Stacking Angle and the color of the current slice as well as that of the spectrum (single color, gradient or hue color). From here it will be also possible to change the colour of the background or to show the title of the spectrum and the title of each slide of the stacked plot just by checking the corresponding check boxes:

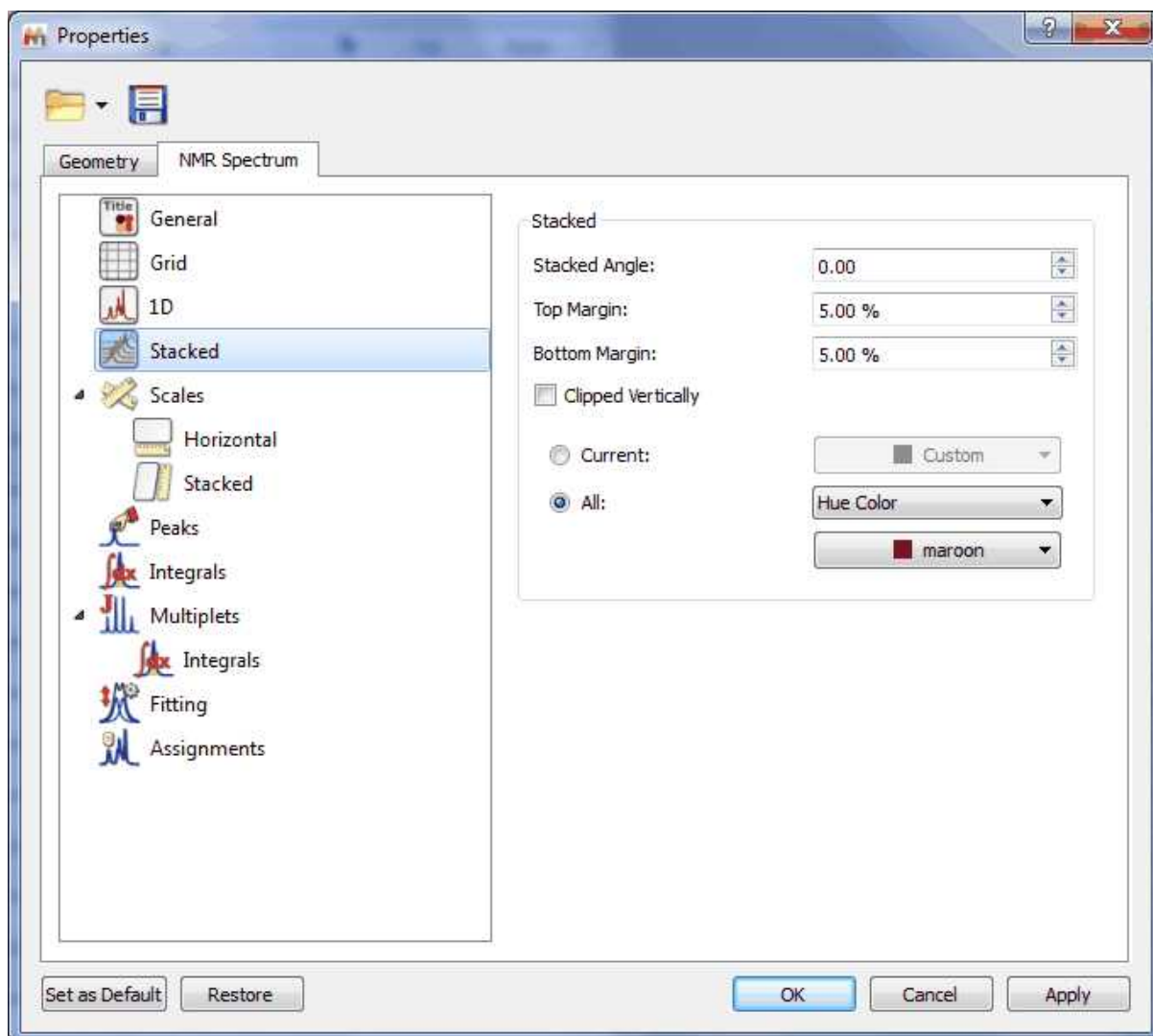

It is also possible to change the top and bottom margins of the stack plot, which is really useful in to avoid clipping a stacked plot at the spectrum border. With this property you will be able to adjust the distance between the top of the spectrum object and the baseline of the uppermost spectrum.

Here you can see an example with a top margin of 5%:

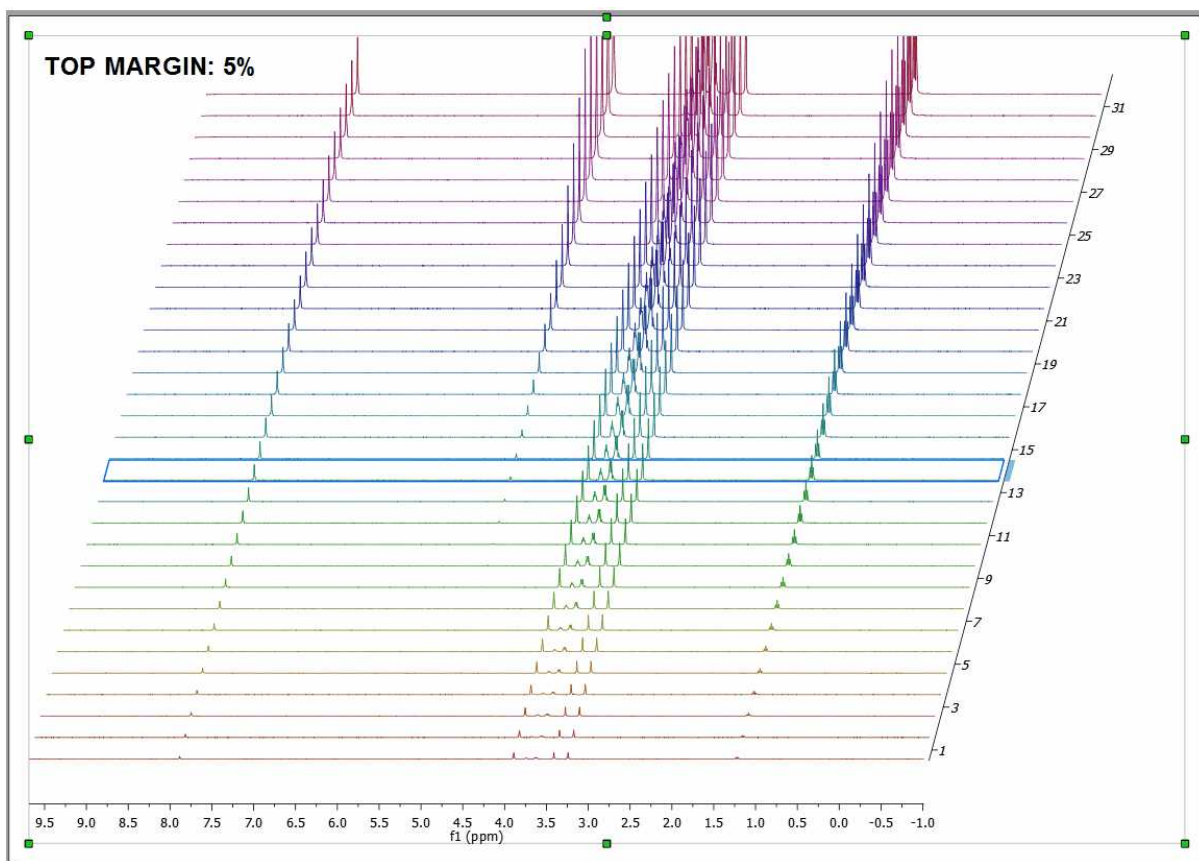

And the applicable result after having selected a top margin of 35%:

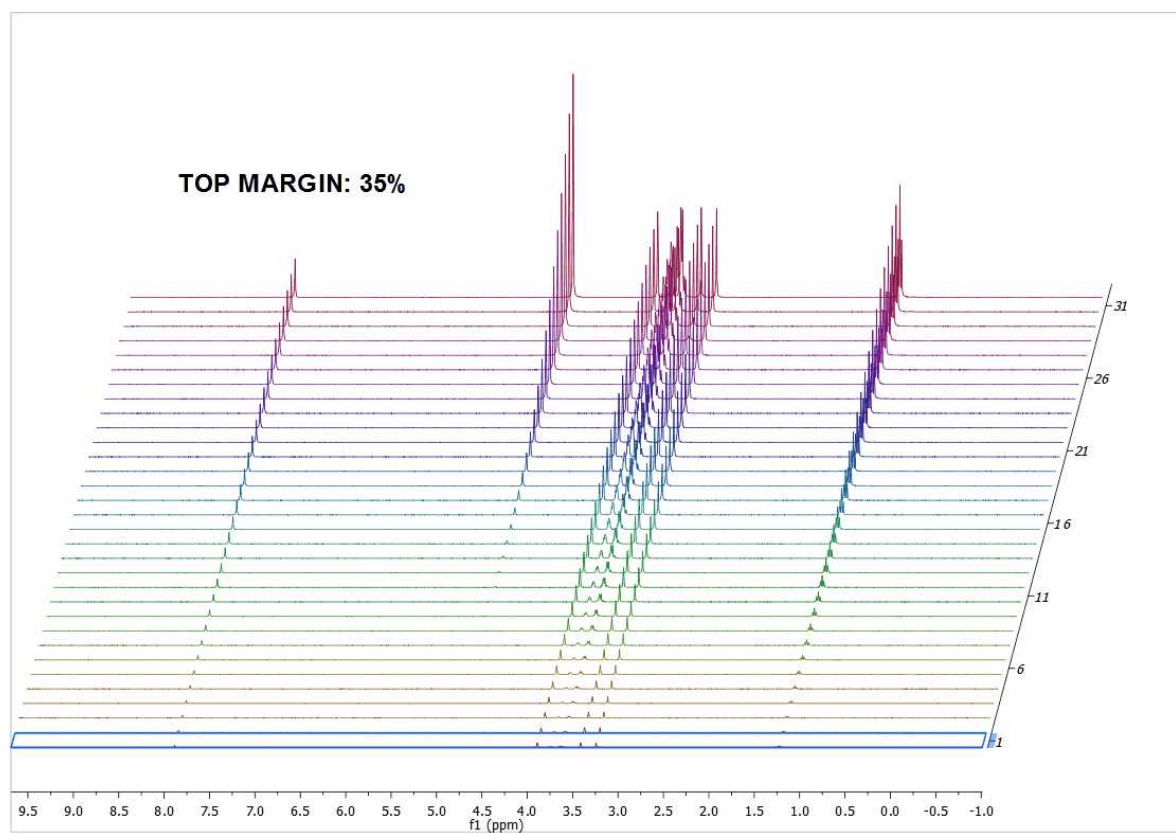

It is also possible to cut off the peaks to avoid overlapping just by checking the **'Clipped Vertically'** option:

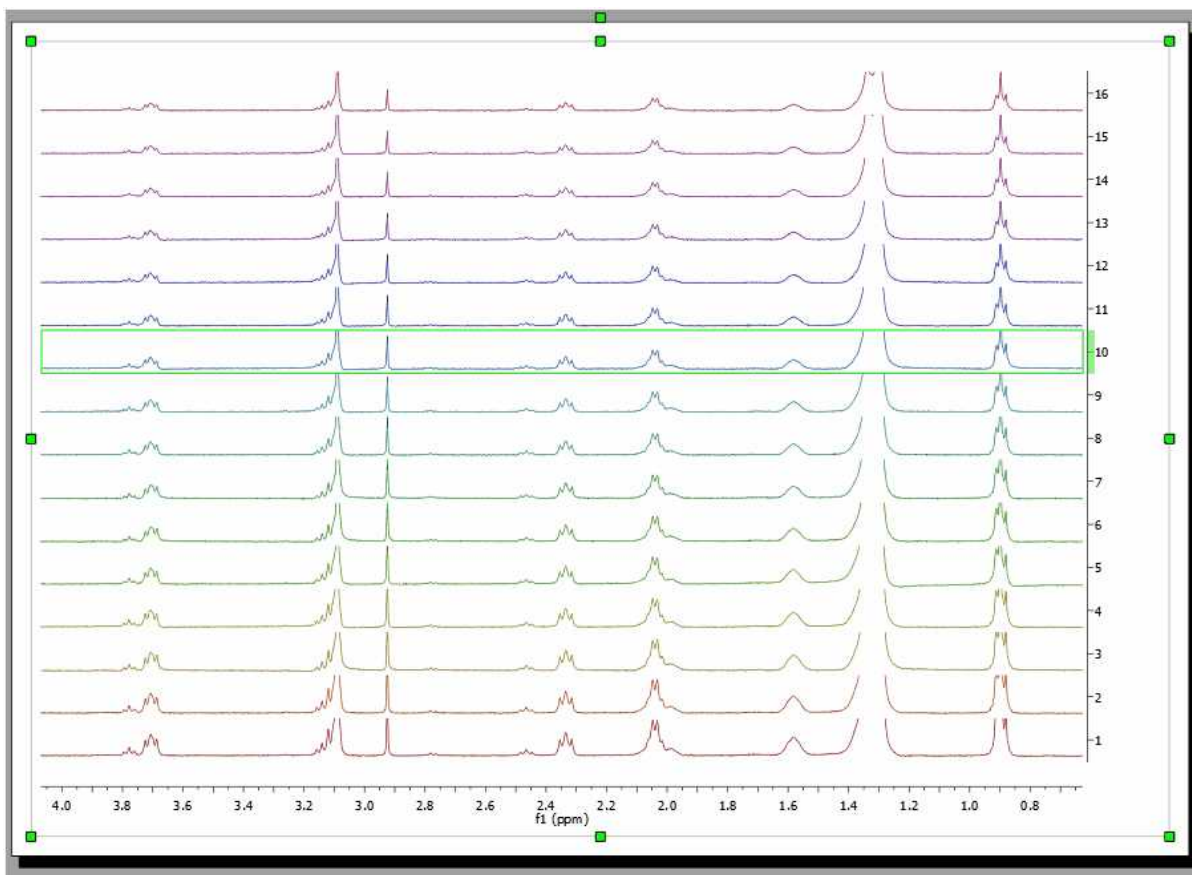

Here you can see an example of a stacked plot with the title of the different traces:

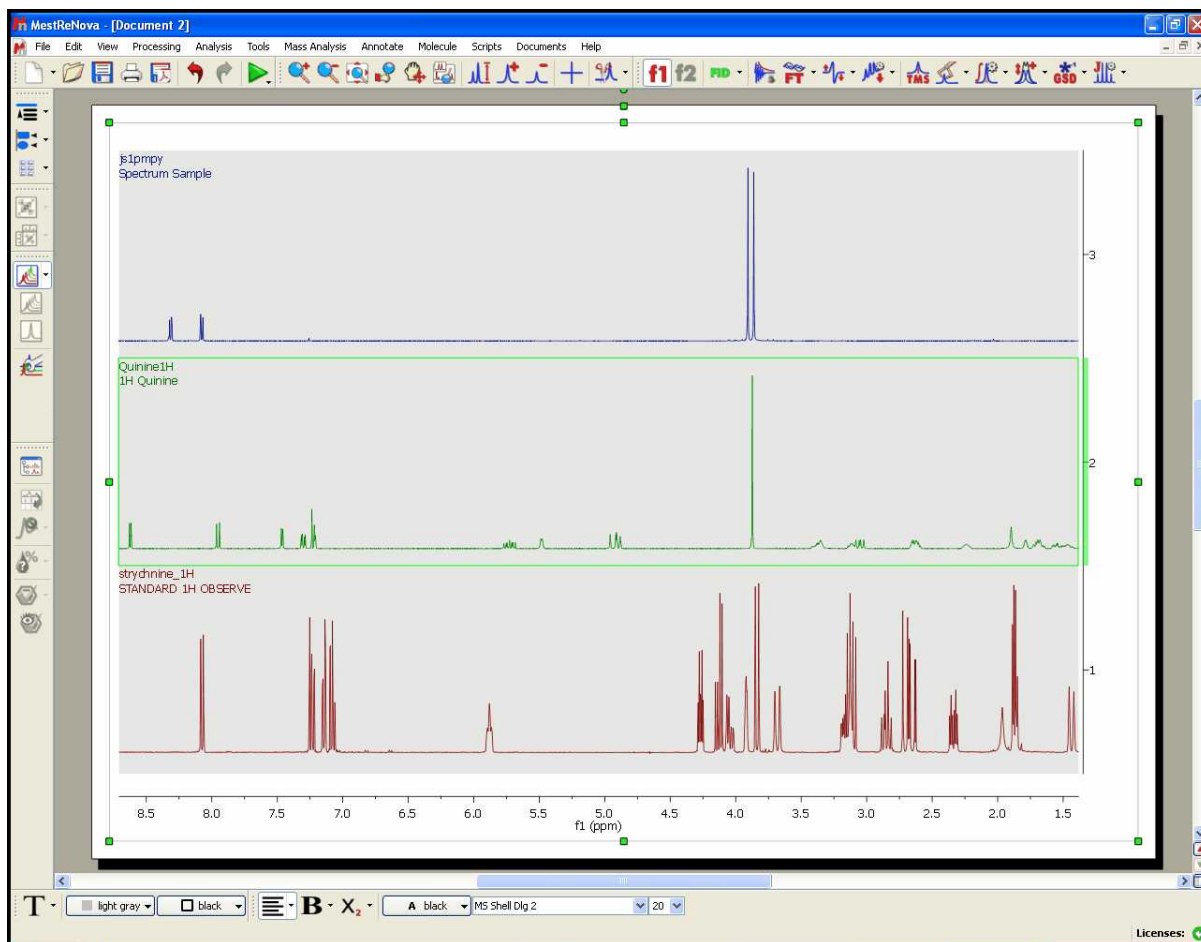

Selecting 'Scales' in the left-vertical tabbed menu, we will be able to change the color of the scale, the font, add labels and also show/hide the horizontal and the stacked axes. From the Stacked menu, you can also change the label and the content (arrayed data or just numbers) of the stacked scale or the minimum width of the scale.

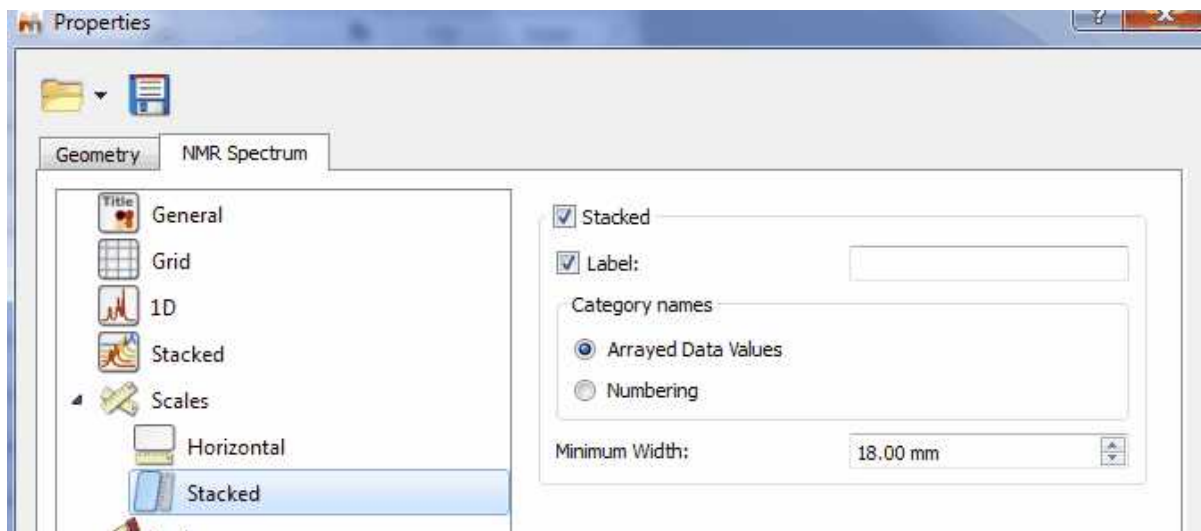

8.4 Fourier Transform

Basic concepts on FT

Modern **NMR** involves pulse RF energy to excite all frequencies at once. Immediately after the pulse, the signal is detected as a time domain interferogram which contains the sum of all the damped-sinusoid signals emitted by the sample at the various nuclear resonance frequencies.

The signal will decay with time as various relaxation mechanisms either dephase the magnetization in the X-Y plane or return the magnetization to the Z axis. The resulting interferogram is called the *free induction decay* (FID, see figure below)

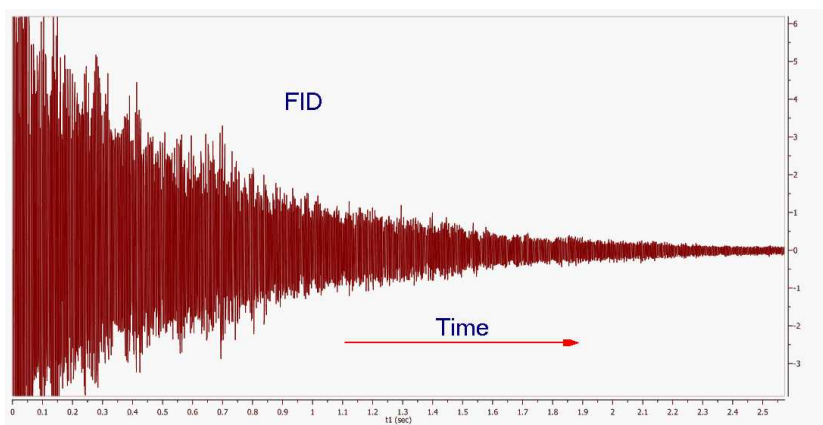

If you pay close attention to the FID shown in the figure above you can appreciate that it is composed of several frequencies. Moreover, if you were able to count the number of peaks and valleys in a given period of time (e.g. 1 second), you might be able to measure the periods and calculate the frequencies of some of the signals composing the FID.

In 'real' life, you don't need to do this conversion by hand. Fortunately, **Jean-Baptiste Joseph Fourier** suggested, while working a study of heat flow, that any function of a variable, can be represented by a sum of multiples of sinusoidal harmonics of that variable. This work was later developed into the Fourier Series.

Fourier's proposals led, in part, to the development of a linear mapping operator which maps a given function to other functions and in our particular case, functions of time to functions of frequency. The operator was named the Fourier Transform in Fourier's honour. In short (math details are beyond the scope of these documents), the Fourier Transform or FT is the mathematical process that converts the time domain function (the **FID**) into a frequency domain function (the spectrum) as illustrated below:

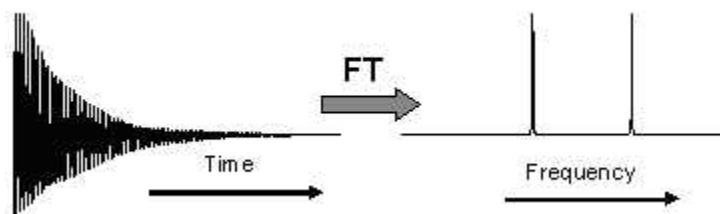

Thus, FT is a mathematical procedure which generates the spectrum from the FID. It searches through the FID for frequency information and allows a plot of signal intensity versus frequency to be

generated. When the frequency information is well defined, the peaks will be sharp, but if the information is not precise, the peaks will be broader.

The Continuous Fourier Transform nitty-gritty involves the equation:

$$A(\omega) = \int_{-\infty}^{+\infty} A(t) [\cos(\omega t) - i \sin(\omega t)] dt$$

where $A(\omega)$ is the intensity of the signal as a function of frequency, $A(t)$ is signal intensity of the FID as a function of time and i is $(-1)^{1/2}$.

Separating the real from the imaginary part, we have:

$$A(\omega) = \int_{-\infty}^{+\infty} A(t) \cos(\omega t) dt - i \int_{-\infty}^{+\infty} A(t) \sin(\omega t) dt$$

The real part can be taken as the signal component which starts off in phase with the receiver reference oscillator, while the imaginary part is that which starts off 90 degrees out of phase with the receiver reference.

The original Fourier Transform is defined for functions of a continuous variable: To meet the needs of pulse NMR where the FID is sampled at short but discrete intervals, the so called **Discrete Fourier Transform (DFT)** is used. When the signal strength has been measured with discrete time-interval sampling, the Fourier integral is replaced by:

$$x(n) = \frac{1}{N} \sum_{n=0}^{N-1} \left[A(n) \frac{\cos(2\pi k n)}{N} - i A(n) \frac{\sin(2\pi k n)}{N} \right]$$

where N is the number of samples, n is the n^{th} sample and $2\pi k$ is a multiplier which converts point n , into the value corresponding to ωt (in rad/s). If we have a collection (named A) of N signal points as a function of time, the calculation of the applicable arrays of real and imaginary frequency points is quite straightforward and can be easily carried out with a computer.

The calculations with many points are obviously slow (though with current computers, they are extremely fast), but the more points, the smoother the plots will be. In order to reduce the computation time we can use the **Cooley-Tukey fast-Fourier algorithm (FFT)**, reducing the number of calculations from N^2 for the **DFT** to $N \log_2 N$ for the **FFT**. If N is 1024 samples the reduction is from 1048576 to 7098, a 93% time reduction. This algorithm has the special restriction that N must be a power of 2. (In cases where the number of points is not a power of 2, Mnova will extend the size of the FID by adding zeros to the next higher power of 2).

The Cooley-Tukey algorithm for the **FFT** achieves this stunning reduction in computation time in part by a process called "bit reversal" which avoids repetitions of internal vector component calculations. The algorithm also saves time by recognizing the orthogonality of certain calculations, allowing the one vector to be calculated from another just by changing an algebraic sign, or reversing sine and cosine terms. This process is an example of the general technique of *divide and conquer* algorithms apparent in many traditional implementations, in which the FT is divided in other more and more small FTs.

Although, as explained in the items dedicated to 1D and 2D NMR Processing, all processing parameters are applied by default by Mnova, prior to Fourier Transform and for Fourier Transform, the

software also incorporates a significant number of algorithms which can be applied by the user to try to optimize the results obtained. Thus, on the scroll menu applicable to the 'FT' icon the user can find the following options to apply:



The shortcut for the FT will be the 'Shift+F'.

FT and Mnova

At first sight it might seem that a plain FFT would suffice to obtain the desired spectrum. However, this is not so in many cases. Although Mnova will adjust the number of samples by zero-filling to obtain a power of 2, the user may elect to increase the zero filling further to double the acquisition power of 2 value to obtain optimum 'frequency' resolution, or even further to improve the 'digital' resolution.

Other operations closely related to the FFT algorithm include:

- Quadrature Detection
- Drift Correction
- Digital Filtering
- Phase-sensitive Protocols

8.4.1 Group Delay

Most of NMR has finally gone totally digital and is now routinely resorting to high-frequency ADC sampling at rates of several tens of MHz, with a tendency to ever higher sampling frequencies. Such a drastic oversampling has clear advantages in simplifying the front-end electronics. It has also many side benefits due to the fact that the subsequent down-conversion to low frequency range is done digitally and therefore theoretically artefact free. This includes perfect, calibration-free quadrature detection and drastic reduction of quantization noise. By the way, such techniques are routine in other areas of electronics (military, astronomy, audio, ...); NMR is just a latecomer to this world.

High-frequency (HF) oversampling, however, has also some problems of its own. The digital decimation from the HF range to the audio range and the contextual digital filtering (a combination of CIC and FIR filters) need to be properly implemented in the hardware in order to be completely transparent to the User.

However, in the case of Bruker and Jeol spectra a death time or group delay can be observed in the FID: it starts with very small values and then, after some points (usually between 60-80 points) the normal FID starts.

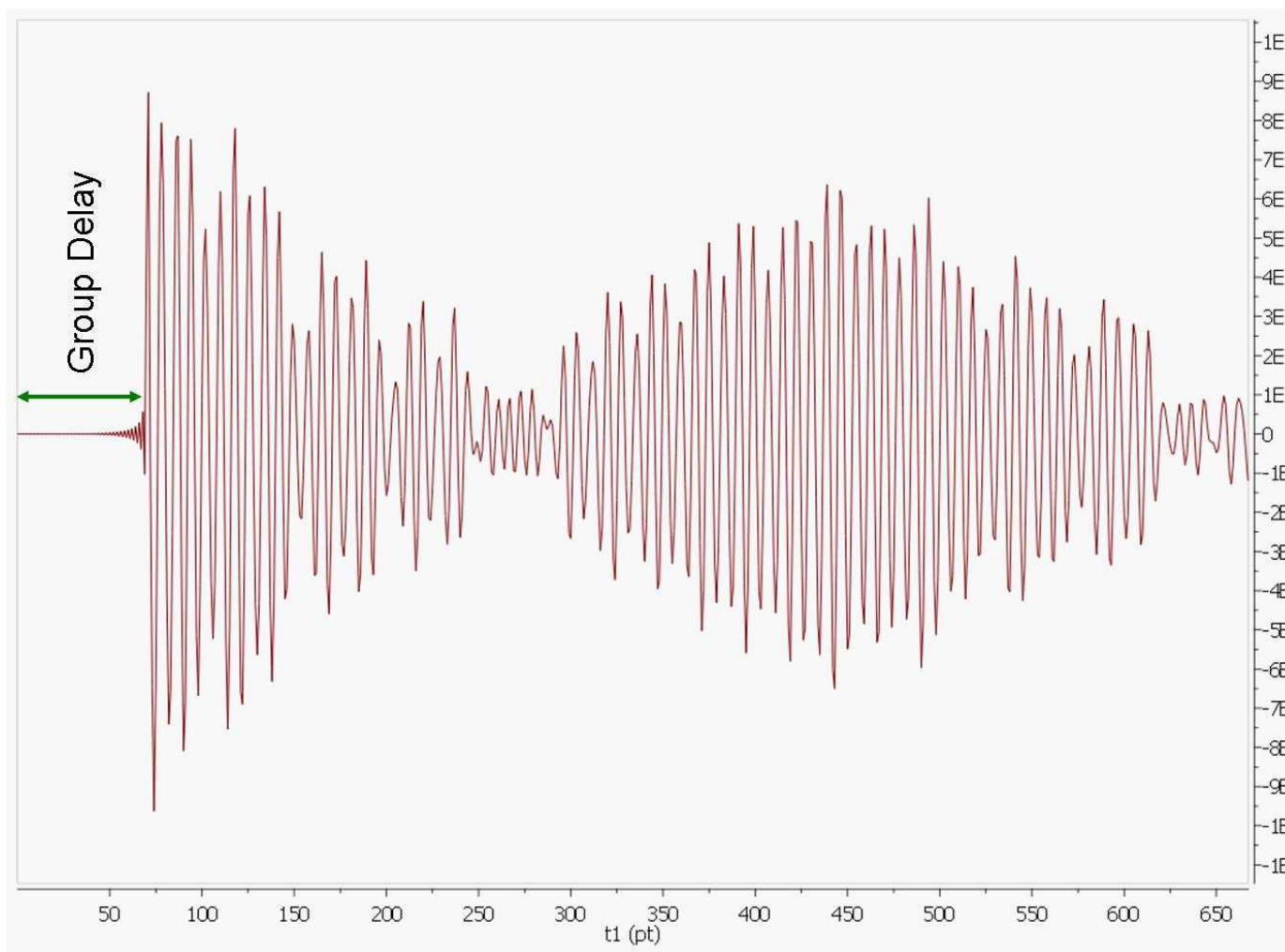

If a plain FT is applied to this FID, we will get a spectrum with a lot of wiggles in the baseline analogous to the convolution with a sinc function centred in the middle of the spectral window. This can be explained by recalling the time shift theorem of the Fourier Transform which says that if the time domain signal is shifted by n points, the frequency domain spectrum corresponds to the standard spectrum (when the FID has not been shifted) multiplied by $\exp(-i2\pi w \cdot n)$. In other words, we have introduced a very large first order phase correction in the spectrum. For example, if the FID is right shifted by 60 points (death time = 60 points), f -spectrum will exhibit a first order phase distortion of $60 \cdot 360 = 21600$ degrees.

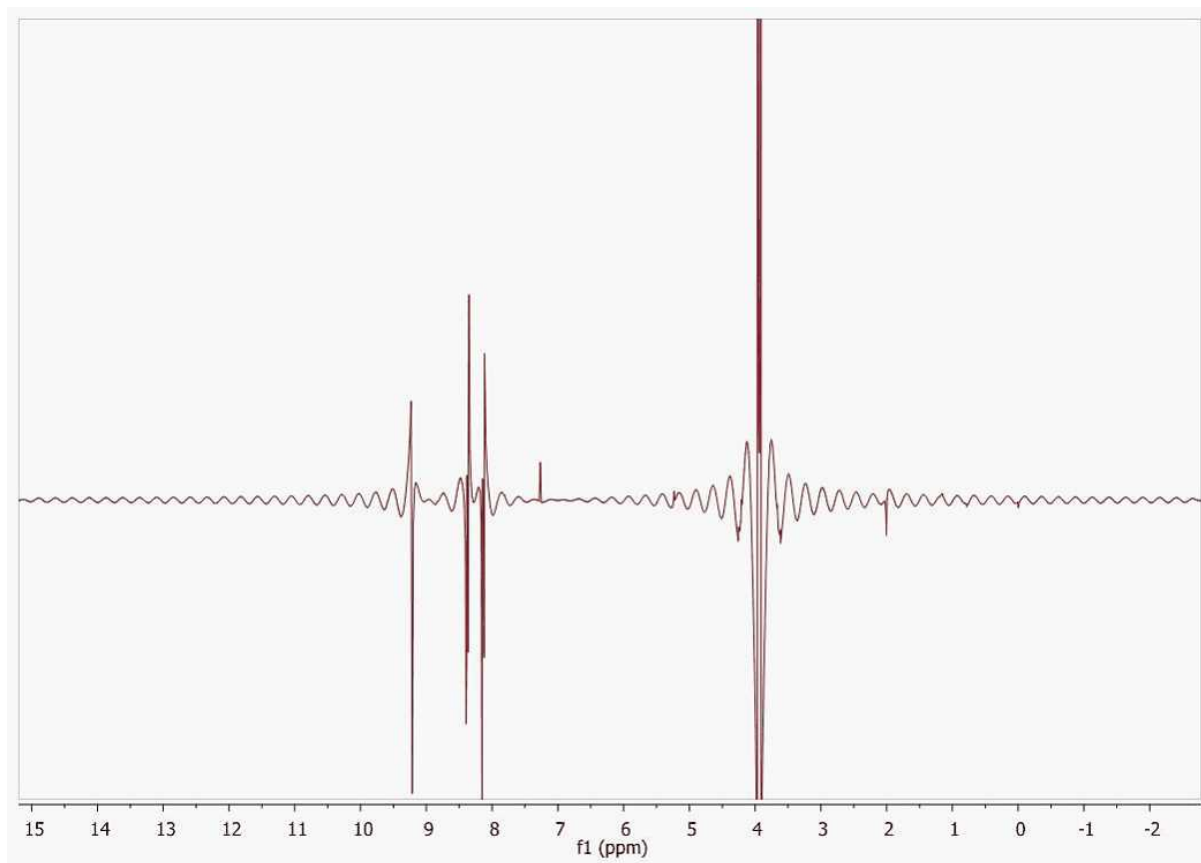

In order to work around this problem, Mnova reads the length of the group delay to be able to calculate the actual beginning of the FID to apply the required correction.

Former versions of Mnova applied a linear phase shift after FT calculated as the product of the group delay length by 360. The problem with this approach is that the resulting spectrum usually shows the so-called smiles at both edges of the spectral width (see figure below)

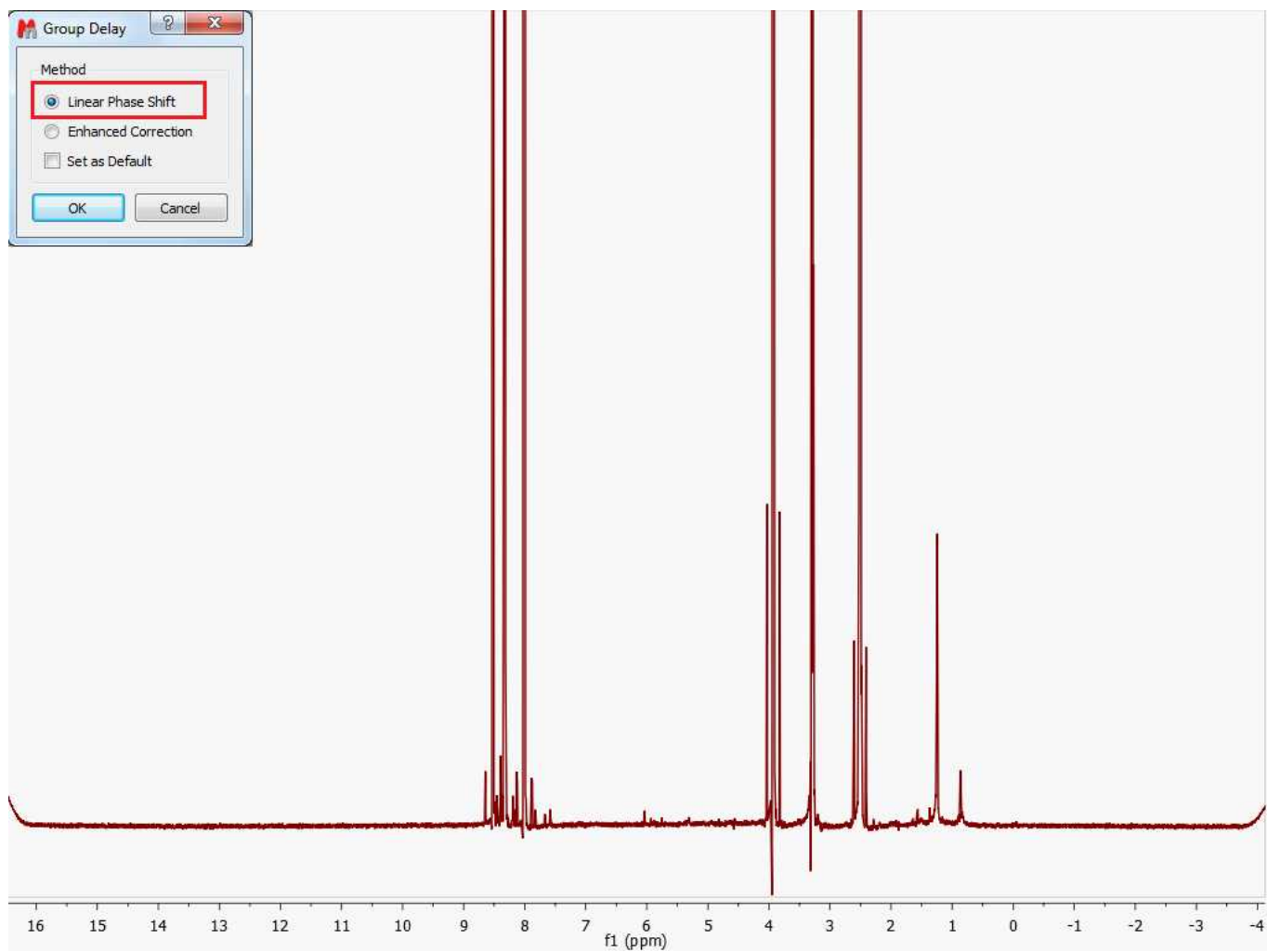

From version 6.1.0 onwards, Mnova includes a new correction algorithm (Enhanced Correction) which produces a normal and physically correct FID in such a way that the smiles/brownies will not be seen in the f-domain spectrum.

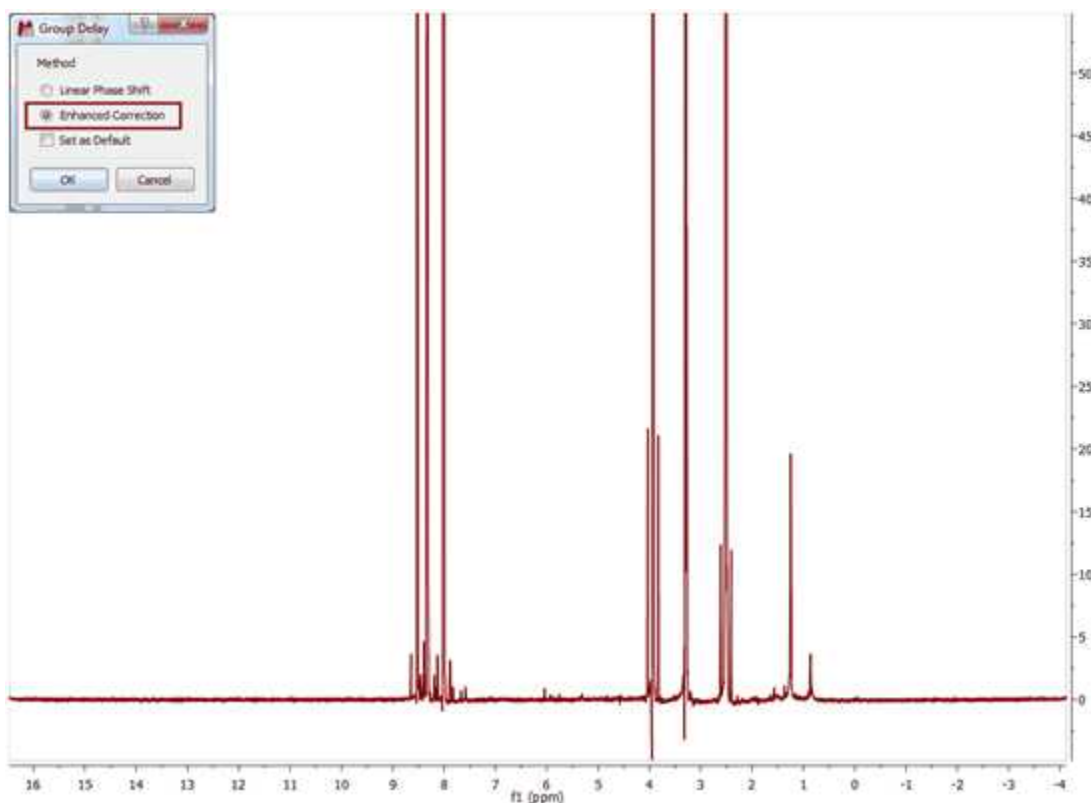

See also: <http://nmr-analysis.blogspot.com/2010/05/bruker-smiles.html>

8.4.2 FID Shift

It is possible to right or left shift the FID by using this command located under the Processing menu of Mnova.

Shifting the FID to the left or to the right is equivalent to shift the phase of the frequency domain spectrum by $-wt_0$.

From a practical point of view this means that if the FID is shifted by one point to the right, the resulting f-domain spectrum will have a linear phase correction of -360° . The same effect, but with the opposite sign occurs if the FID is shifted to the left.

This phenomenon is very easy to understand by considering the well-known property of the **Fourier Transform of a Time Shifted Signal which can be stated as:**

The Fourier transform of a signal which has a simple time shift is:

$$\mathcal{F}\{x(t - t_0)\} = e^{-j\omega t_0} X(j\omega)$$

i.e. the original Fourier transform but shifted in phase by $-wt_0$

For example: if you type -10 in the edit box, this will be equivalent to apply a linear phase correction of $+10 \times 360^\circ$.

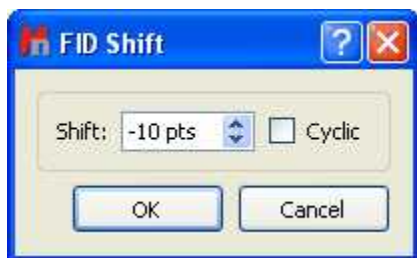

Basically, in this example, Mnova will not take into account the first 10 complex points of the original FID; shifting the origin of the new FID 10 points to the left and adding 10 zeroes to the end (i.e., left shift 10 points). Clicking on the Cyclic check box will add the original first points to the end of the FID (instead of zeroes).

Here you can see an example of a FID which needs to be shifted +11 points:

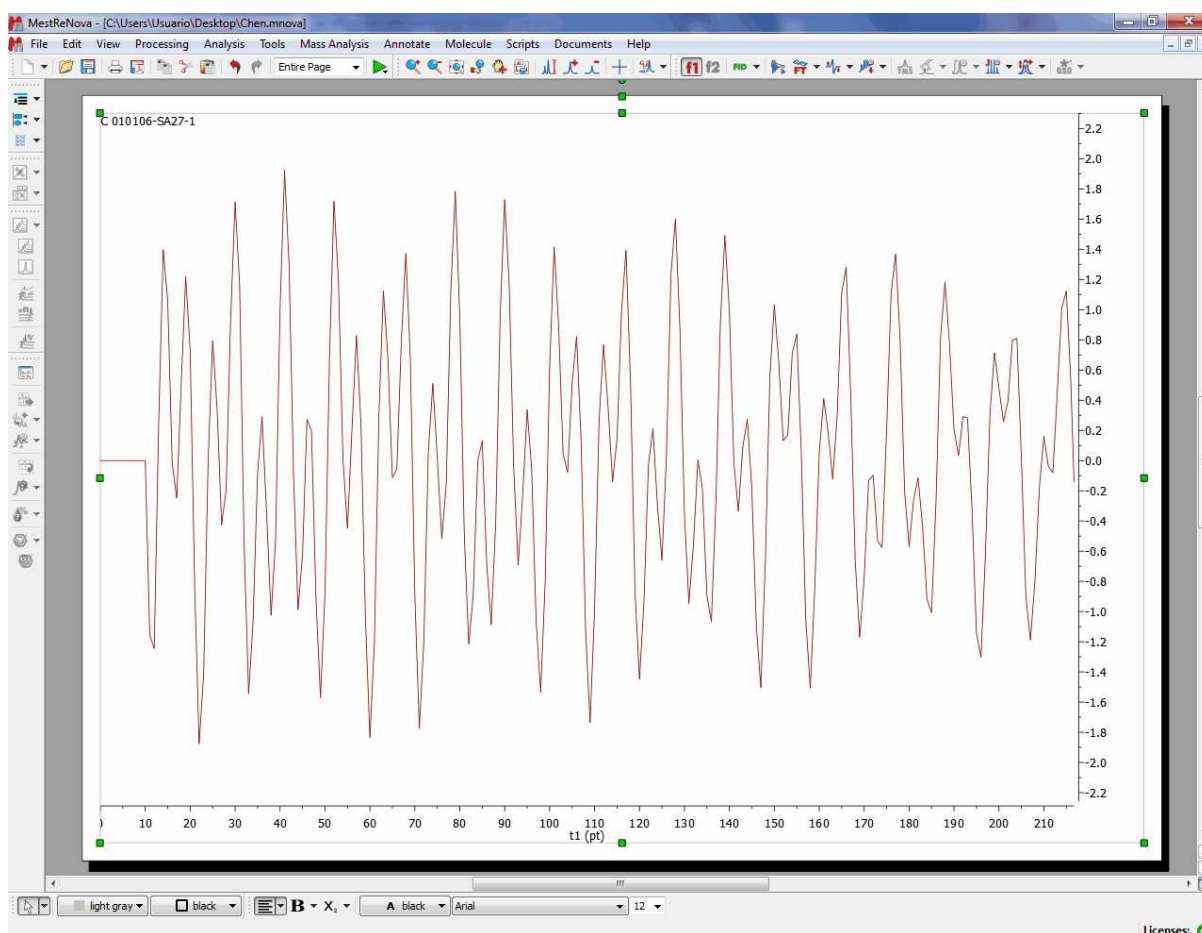

8.4.3 Diagonal Suppression

Diagonal Suppression (Not available in Mnova Lite):

In the [1D NMR Processing](#) section, we described the real-time frequency domain processing concept. **Diagonal Suppression** of homonuclear 2D experiments represents another example of this concept. This technique is typically carried out in the mixed time-frequency domain (interferogram). However, this is something you do not need to know in Mnova. You can suppress the diagonal while the transformed spectrum is on the screen.

For example, the figure below shows a 2D magnitude spectrum:

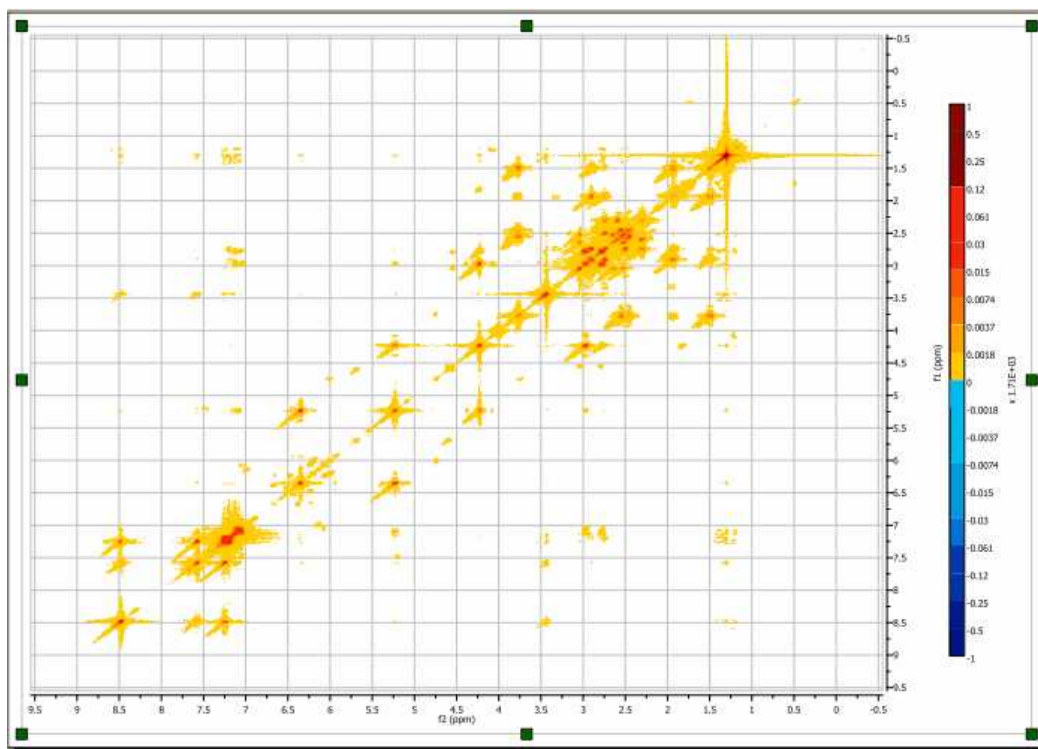

To suppress the diagonal, just click on the small arrow at the right-hand side of the FT toolbar button (see below) and select the **Diagonal Suppression** command:

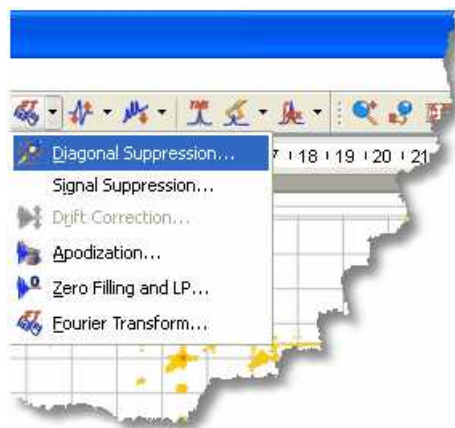

This option offers a couple of well known traditional algorithms (Convolution and Shifted Convolution) as well as a new, in-house developed algorithm based on Wavelets to remove the diagonal from homonuclear spectra. Once you select the 'diagonal suppression' on the FT scroll menu, a dialog box like this will open:



As you can see, you can select the desired algorithm and also the selectivity of the diagonal suppression. In the case where you choose the in-house algorithm based on Wavelets, you will be able to set the 'Dyadic Levels' and the 'Daubechies Coefficients'.

In this example we will select the Wavelet method; and this is the resulting diagonal-free spectrum.

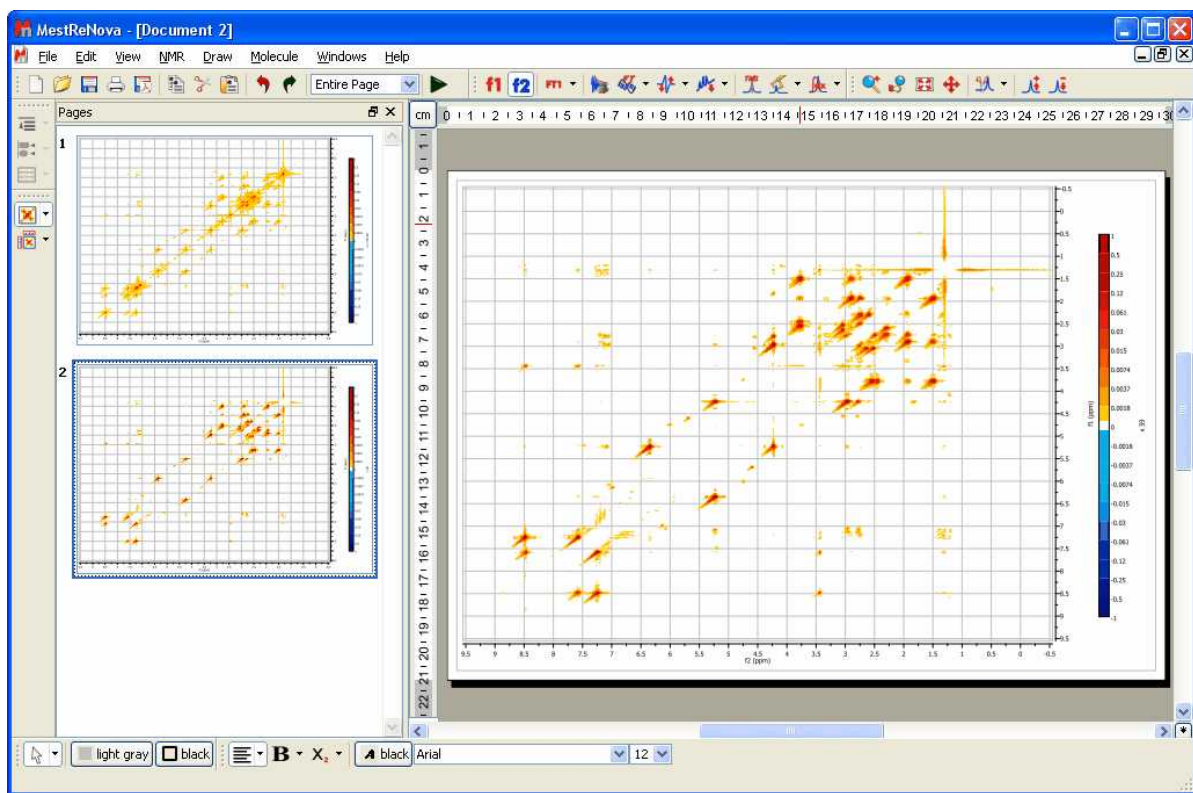

Note that in the figure above there are two pages, the first one containing the 2D spectrum with its original diagonal, and the second one after the diagonal has been removed.

8.4.4 Signal Suppression

Signal Suppression (Not available in Mnova Lite): Strong solvent resonances with solutes of low concentration can result in a lot of problems relating to spectrum quality. One of the primary challenges in obtaining High resolution NMR spectra of biological samples is the suppression of the water resonance to prevent it from overwhelming the signals of interest.

This option is intended to suppress the solvent signal but can also be used to remove any other signal

from the spectrum. To suppress the signal, you can select the method (algorithm) of the suppression and the selectivity (or width of the filter; a higher value of selectivity will suppress a narrower band). You can choose the signal, or signals, by double clicking on the applicable table titled 'Signals to Suppress'.

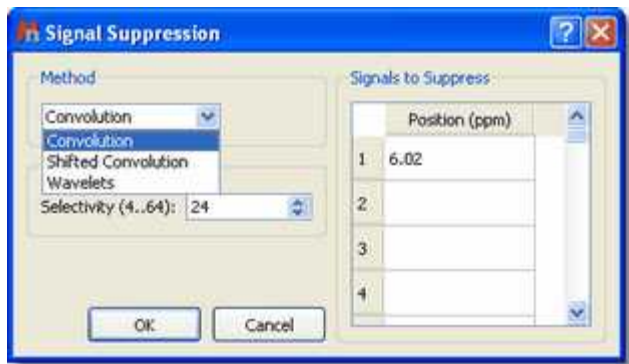

Utilities:

The 'Signal Suppression' tool is extremely useful when working with proteins, in which spectra are usually measured at very low concentrations in aqueous solutions.

Here you can see an example:

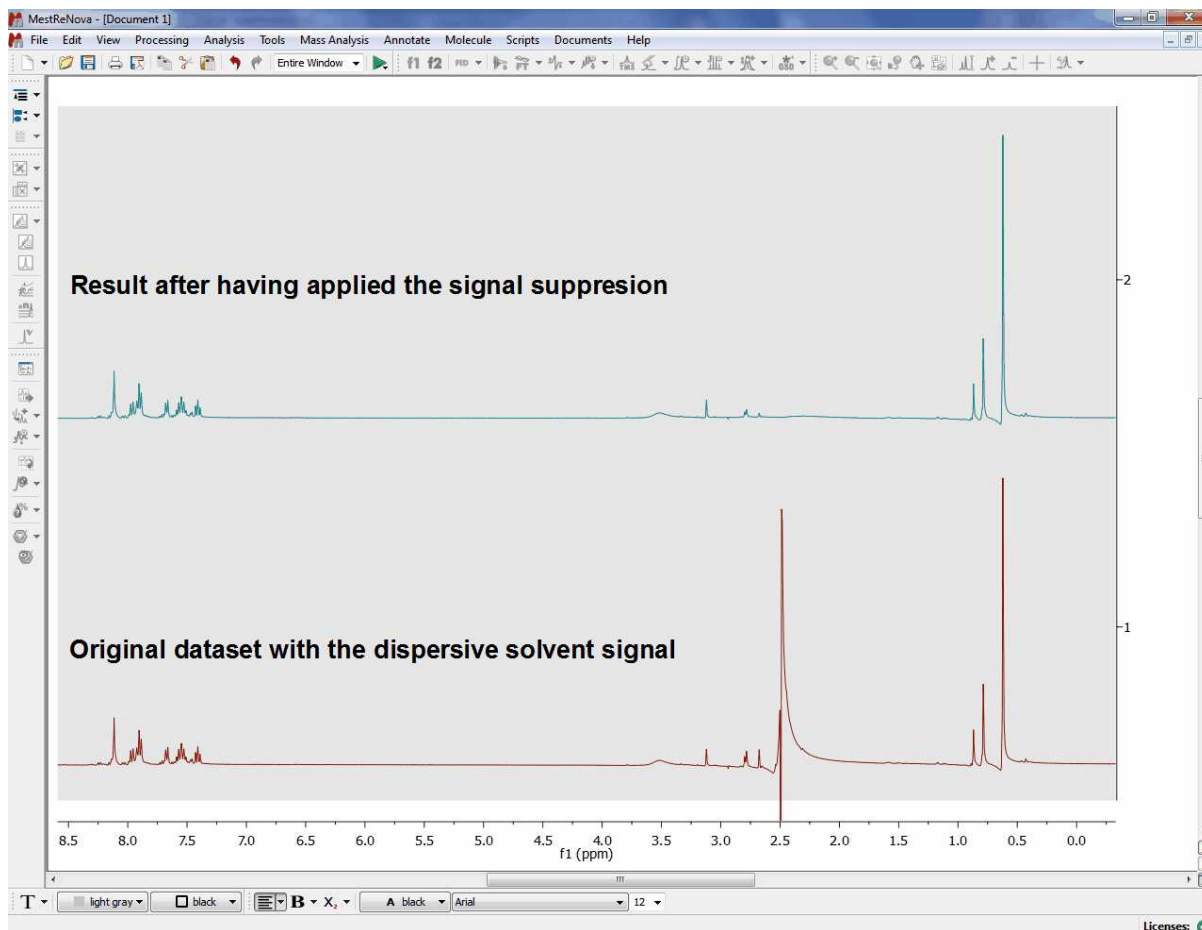

8.4.5 Apodization

Apodization (or Weighting or Windowing): literally, apodization means '*cutting off the feet*' in the original Greek. In this case, the feet are the *leakage or wiggles* which appear when the signal decays rapidly to zero producing an abrupt truncation of the FID, as can happen for example when zero filling. Apodization is a very useful approach to enhance the S/N ratio (sensitivity) or the resolution, or even to remove truncation artefacts, after data has been collected.

The most commonly used apodization function is a decaying single-exponential curve. The magnitude of the decay constant determines how quickly the curve decays. In a regular FID, the resonances due to the sample are found in the earlier parts of the signal. When you multiply the FID by a decaying-exponential function, you favour the early parts of the time domain and attenuate the data at the end of the acquisition period, which is essentially all noise. A single exponential apodization function does not significantly affect the signal at short times, but it greatly reduces the noise at later times; at the expense of an increase in linewidth, that is to say, a decrease in the resolution. On the other hand, if you use an *increasing exponential curve* as apodization, you will obtain finer lines (increased resolution) but amplifying the noise (decreased sensitivity).



Utilities:

Windowing is particularly useful in ^{13}C -NMR spectra and extremely important in multidimensional-NMR to increase the signal/noise ratio or to improve the resolution.

The Window function is applied by multiplying the data vector d , element by element, by a vector a . Thus element k of vector d is multiplied by element k of vector a to yield element k of vector d' .

$$d'_k = a_k d_k$$

The challenge lies in finding a vector a , such that the noise in the tail of the FID is attenuated without excessive line broadening or, in the case of apodization, to smooth the truncated data exponentially towards zero, again without excessive line broadening. Theory shows that this is attained when the decay of vector a matches the decay of vector d ; in this case we have what is known as a *matched filter*. Mnova makes this particularly easy by allowing the final spectrum to be observed while the decay parameter of the window function is adjusted.

Mnova incorporates many window functions (Exponential, Gaussian, Sine Bell, Sine Bell Square, TRAF, Trapezoidal, Parabolic, Hanning, Convolution Difference and Linear Ramp), which can be combined and can be used interactively (while viewing the FID as well as the resulting spectrum) to improve the sensitivity or the resolution. Unfortunately, it is very difficult to find a function which improves sensitivity and resolution simultaneously (an exception could be the Traficante function, as we will see later).

You can find this tool on the FT scroll menu on the toolbar or by following the menu 'Processing/Apodization' (shortcut: W):



Once you have selected '**Apodization**', a window like this will open:

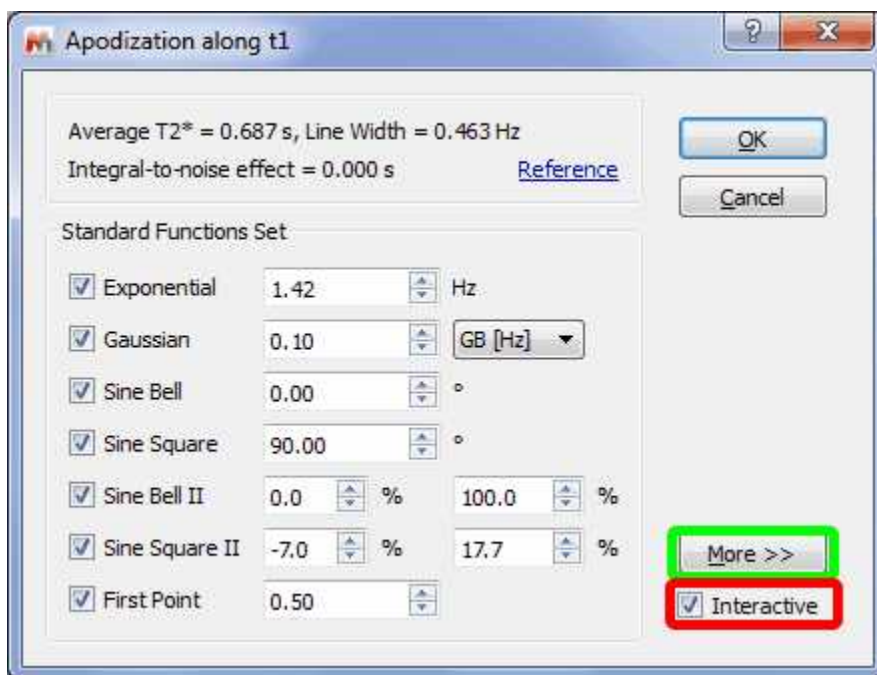

In this dialog box you will find the type of window function which Mnova has applied prior to FT, as well as other Standard Functions (Gaussian, Sine Bell, Sine Square and First Point). If you click on 'More >>' (in the green square in the figure above), you can set other Advanced Functions, as shown below:

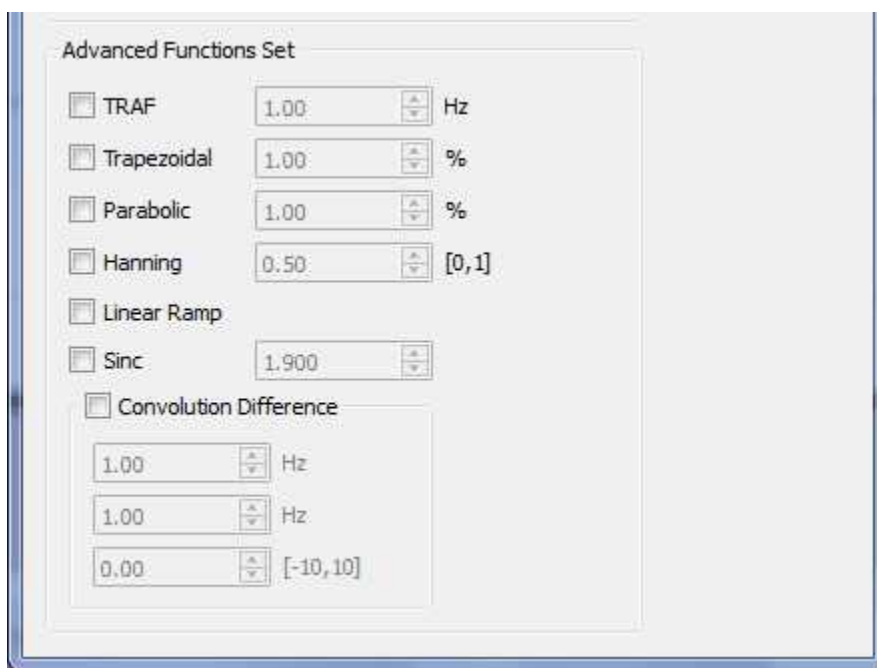

In order to assist in the process of finding the most suitable window function and its parameters, Mnova allows the user to interactively adjust the parameters of window functions, and to view the effect directly on the frequency spectrum. For this purpose, make sure the 'Interactive' box is ticked (highlighted in red in the figure), you can then follow the exact effect of the function you are applying on

the frequency domain spectrum (or on the FID, if you are on the FID' view) by using the buttons  to change the desired parameter. If you have activated the 'Full View' window you will be able to see the

window function displayed along with the FID.

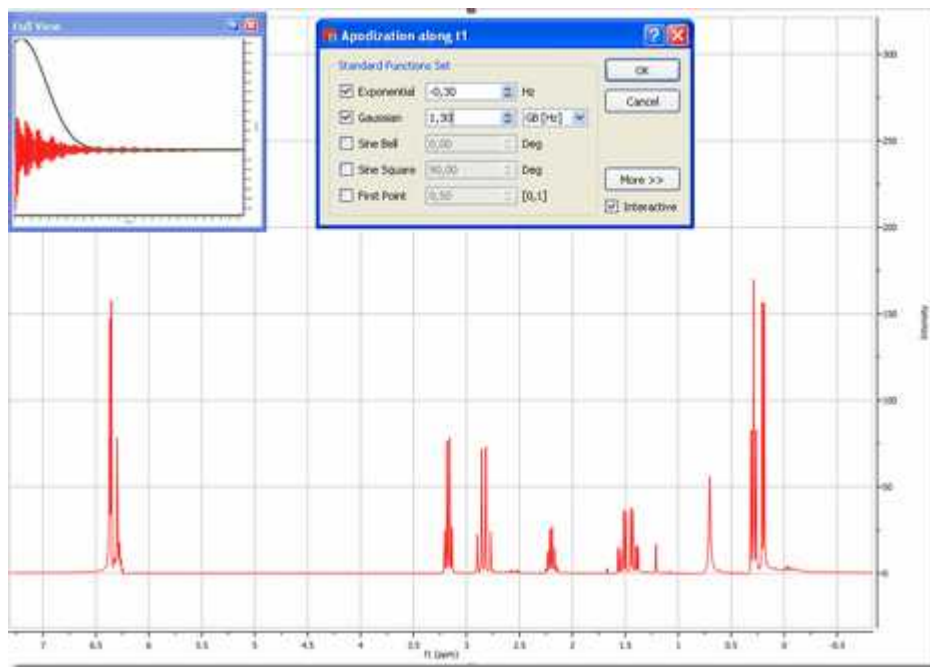

We will try to explain in a brief and easy way the applications and the effects of these functions:

Exponential: A exponential apodization function is defined as:

$$a_k = e^{-\pi W k \Delta t}$$

where W (the parameter to adjust) represents the the line broadening factor expressed in Hz. So, if the original width of the signal is ' L ', the final width of the signal after applying this window function would be ' $L+W$ '. If W is positive we will have a *decaying exponential curve* (and we are giving more weight to the points at the beginning of the FID and suppressing the data at the end of the time series, which is essentially all noise). As we explained previously, this will increase the '**sensitivity**' (Signal to Noise Ratio) of the spectrum at the expense of an increase in linewidth (decreased resolution).

The figure below shows the effect of W on the linewidth. The black trace has no window function applied. The red trace shows a taller signal due to application of an **Exponential Function** and also an increase of the Signal to Noise Ratio (matched filter), while the blue trace shows that if the **Exponential Function** is too severe the broadening of the lines reduces the signal size again.

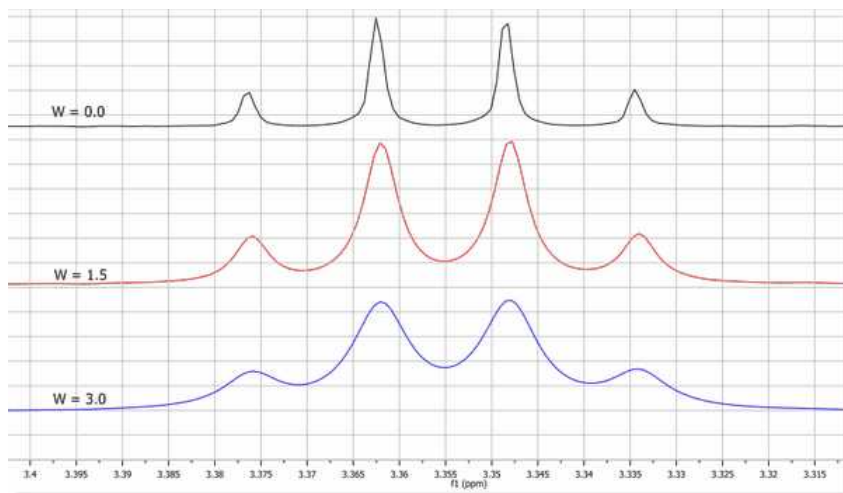

If W is negative, we will have an *increasing exponential curve*, thus obtaining the opposite effect (increased **resolution**, with finer lines, and a decrease in sensitivity, i.e., a lower S/N ratio). You can see below the graphical difference between an *increasing and a decaying exponential curve* over the FID (shown in the 'Full View' window). Note that in this case an *increasing exponential curve* will not be a good choice (it is normally used in combination with other functions, such as Gaussian).

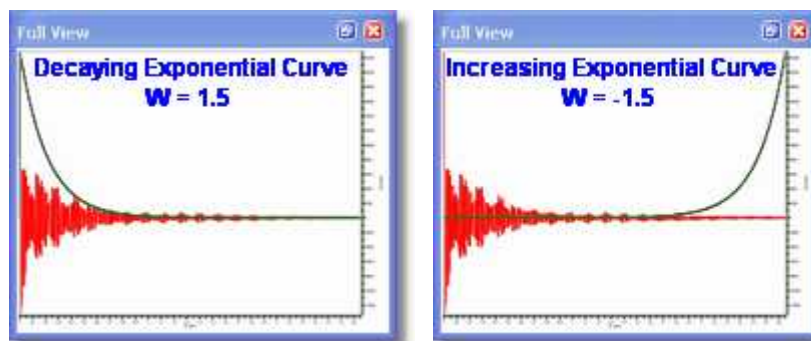

In most of the literature this parameter is symbolized by LB (*Line Broadening*).

Gaussian: In Gaussian window function resembles the Gaussian Probability Distribution function used in statistical analysis. The gaussian function rises quasi exponentially to its single maximum and then falls back to zero in the same manner and so may be regarded as almost two back-to-back exponentials.

In Gaussian apodization, each data point of the FID is multiplied by the vector:

$$a_k = e^{-W(k\Delta t)^2}$$

where W is the same widening factor used in exponential apodization. This function is similar to the exponential but decays comparatively slowly at the beginning of the FID and then quite rapidly at the end. For this reason, it causes less line broadening than the exponential multiplication.

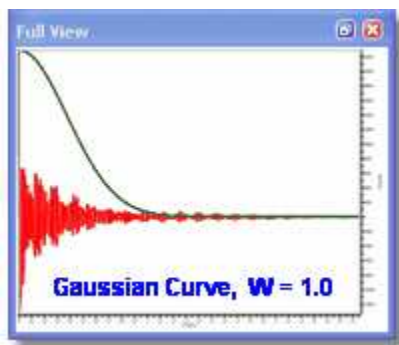

In the next picture, you can see the influence of W over the linewidth:

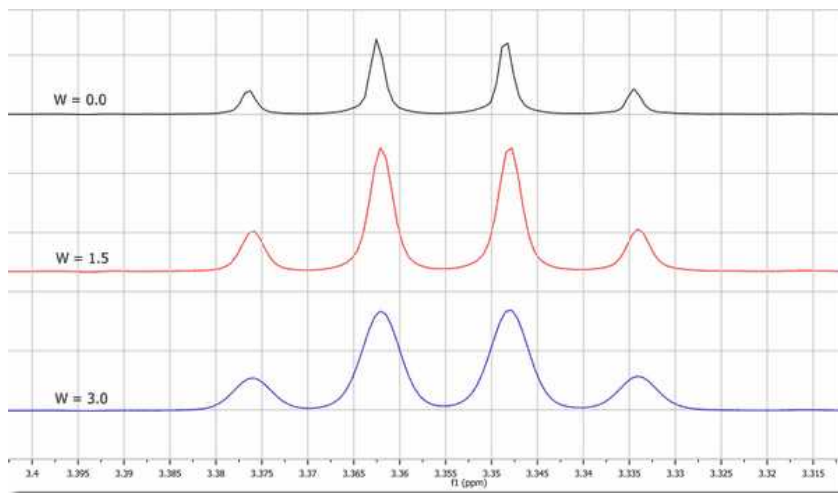

Gaussian plus Exponential: This function is also known as Lorentz-to-Gauss Transformation and is not directly implemented in Mnova, but you can apply it by ticking both exponential and Gaussian multiplication functions and introducing a negative value for the exponential line broadening (W) and a positive value for the Gaussian parameter (GB). The spectrum can be optimized for resolution by suitably adjusting these parameters.

Thus, this weighting function combines a rising exponential function with a decreasing Gaussian function; then, the resulting vector will be:

$$a_k = e^{\pi W k \Delta t} e^{-W(k \Delta t)}$$

To perform Exponential/Gaussian apodization with Mnova, select the Apodization option in the FT scroll menu on the toolbar, then click on the Exponential as well as on the Gaussian resolution enhancement option and finally enter the appropriate values of W (or LB) and GB and click OK.

Usually, a process of trial and error is adopted with the parameters being adjusted until the best result is obtained. You can follow (by ticking on the 'Interactive' box) the exact effect of the function you are applying on the frequency domain spectrum or on the FID window (shown graphically in the 'Full View' window), as you can see in the screenshot below.

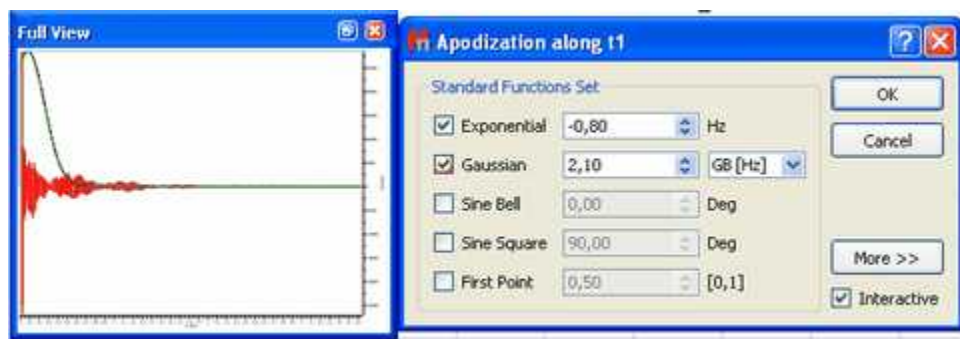

GF (Gaussian Factor) is a number between 0 and 1 and defines where the maximum of the function will be, as a fraction of the acquisition time.

Sine Bell (Not available in Mnova Lite): This function is very useful in those NMR experiments where the signals of interest are not maximal at the beginning of the FID and very convenient for magnitude spectra because it reduces the dispersive part of the line shape.

In COSY experiments the cross peaks are sine modulated while the diagonal peaks are cosine modulated. Sine bell windowing thus emphasizes the cross peaks and attenuates the diagonal signals. Unfortunately due to differing relaxation times for some signals possibly not all cross-peaks will be maximal at the same time; in this case the sine-bell may be shifted to yield the best compromise spectrum. The unshifted sine-bell also removes dispersive signals from the absolute value COSY, providing the sought for absorption line shape.



Utilities:

The **Sine Bell** window function is very useful for **COSY** experiments because it emphasizes the sine-modulated cross peaks compared with cosine-modulated diagonal peaks.

Avoid using this function with 1D spectra since it decrease the spectral intensity. If used with phase sensitive experiments the sine bell can result in signals with negative side lobes and near zero integrals.

This function consists in the multiplication of each data point of the FID by the next vector:

$$d_k = \sin \left(\beta + \frac{(\pi - \beta)t}{t_{acq}} \right)$$

Mnova requires you to enter the β parameter, whose input is expressed in degrees. When $\beta = 0$; the equivalent function is a sine-bell, while when $\beta = 90$ the equivalent function is a cosine-bell. In the pictures below you can see the representations of the sine bell functions resulting from different values for β :

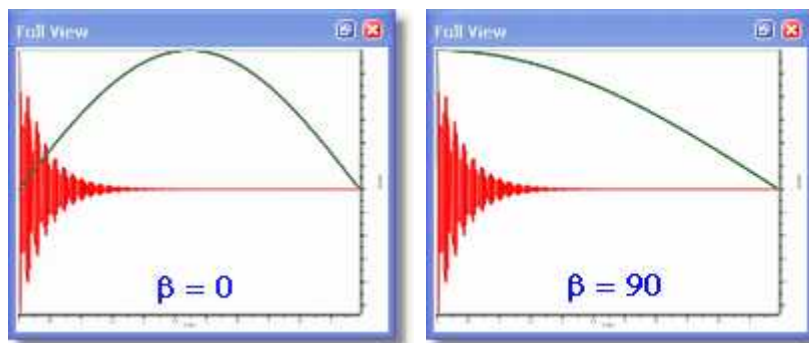

The cosine-bell apodization ($\beta = 90$) is very convenient in 2D-HSQC experiments:

 **Utilities:**

The **cosine-bell** weighting function ($\beta = 90$) is very convenient in 2D-HSQC experiments.

It is also possible to use the Varian version of sinebell apodization in Mnova which is given by the formula:

$$\sin((t \cdot \pi) / (2 \cdot sb))$$

where sb is the sinebell value in seconds and t is the individual FID time values. For function values less than zero, the function is truncated (i.e., only the first set of positive values are used).

As you can see it is also possible to adjust the time-period of the SineBell (like the "sb" parameter in VNMR)

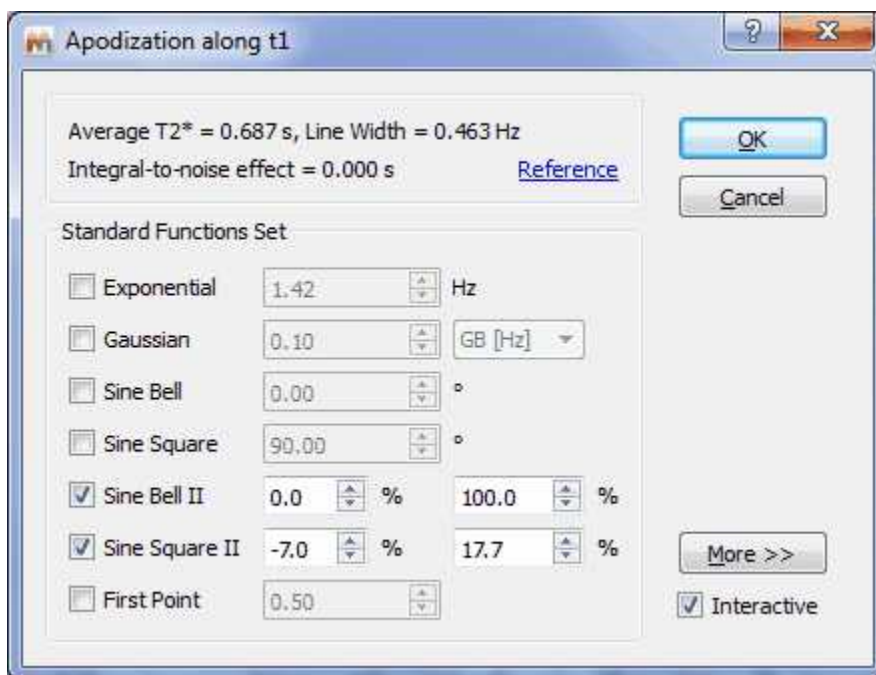

Sine Square (Not available in Mnova Lite): The shape of the Sine Bell weighting function is altered by

squaring it, resulting on the **Sine Bell Squared** function, which is more concentrated over the maximum. It is very useful to use a 90° shifted sine-bell squared to apodize 2D phase-sensitive experiments.

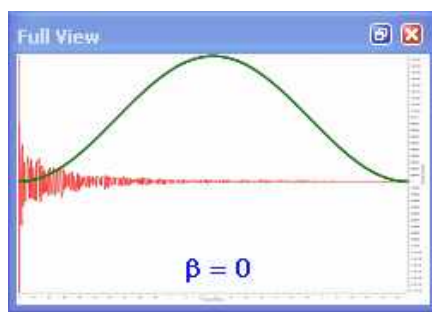

First Point Correction: There is an important difference between the *discreet* FT and the *continuous* FT. The *discreet* FT generates a constant vertical displacement of the baseline, which can be due to a distortion of the first point of the FID. It treats the FID as a function which is repeated periodically, thus the ordinate at $t=0$ would represent the algebraic average of the first and the last point. In most FIDs, the value of the last point is very close to zero, and thus the first real point would have to be divided by two, before introducing it in the FT algorithm. It is often necessary to multiply the first point of the FID by 0.5 before FT in order to ensure that the value of the integral over the spectrum is equal to the value of the first point of the FID.

You can alter this multiplication parameter by entering the desired value (it should be 0.5 by default, as you can see in the FT dialog box below).

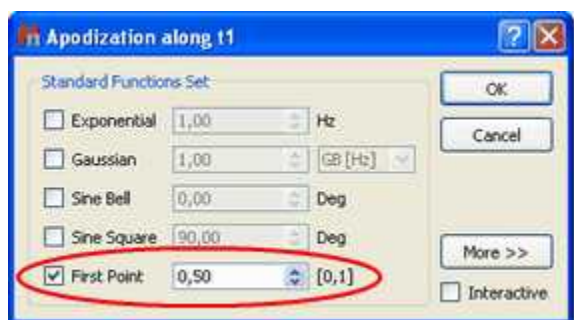

The functions which follow are accessed via the [More >>] button in the Apodization dialog box.

Traficante (Not available in Mnova Lite): The Exponential Multiplication Gaussian and the combination of both can improve spectral resolution at the expense of some loss in SNR. The Traficante window function endeavours to improve resolution without noticeable loss in SNR. Traficante enhances the middle part of the FID and then uses a matched filter to attenuate noise in the latter part of the time-series. The process involves the division of the FID by the sum of the squares of the FID and its reverse. If there are N data points, the k^{th} point in the original FID is point k while the applicable point in the reversed FID is point $(N-k)$. As the resulting FID is symmetrical (with respect to the midpoint), we can multiply it by a function to obtain a new desired FID which does not decrease.

So, if we named the original FID E , and the reversed FID ε , we would get:

$$E \cdot g(t) + \varepsilon \cdot h(t) = 1$$

And Traficante apodization will consist of the multiplication of the FID by the following vector:

$$a_k = \frac{e^{-\pi W k \Delta t}}{(e^{-\pi W k \Delta t})^2 + (e^{-\pi W (N-k) \Delta t})^2}$$

In the picture below, we can see a Traficante function represented (with $W = 2$) applied to the FID

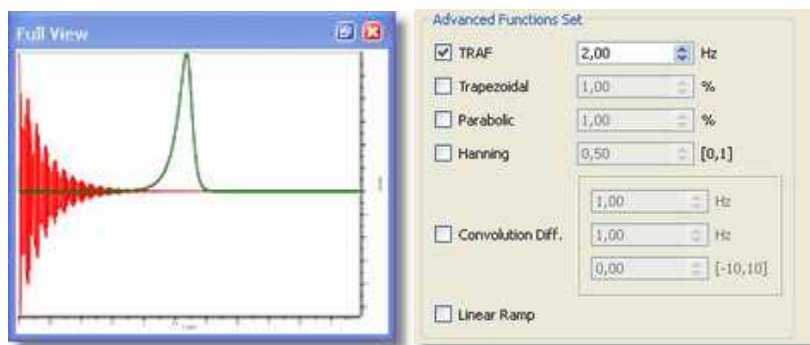

IMPORTANT:

Traficante apodization will be only useful if the FID decays exponentially and, moreover, the value of W must be chosen with care.

Trapezoidal (Not available in Mnova Lite): This function multiplies the FID by a trapezoidal shaped function;

$$f(t) = 1 \dots \dots \text{when } t \leq k$$

$$f(t) = 1 - \frac{t - k}{T - k} \dots \dots \text{when } t > k$$

where T is the acquisition time and k is the percentage of the total length of data

This option is useful to avoid the "sinc" artifacts resulting from truncation of the FID. You can select the percentage of the total length of data between 0% and 100% (k), in the advanced functions of the FT menu:

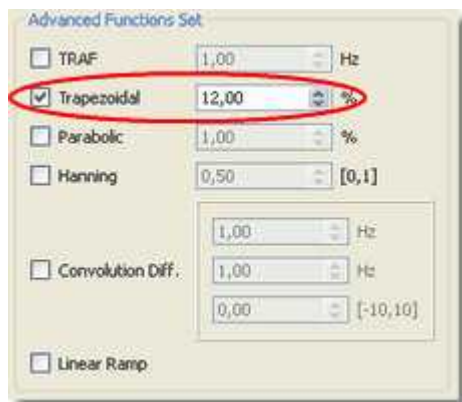

Parabolic (Not available in Mnova Lite): This function multiplies the FID by a parabola shaped function, where

$$f(t) = 1 \dots \dots \text{when } t < b$$

$$f(t) = 1 - \frac{t - b}{[t(\text{max}) - b]^2} \dots \dots \text{when } t > b$$

You can also set the length of the parabola by selecting (on the FT scroll menu) Apodization, click "More", select parabolic and then choose the desired value for the parameter (b , expressed as the total length of data). Again, you can see the exact effect of the function you are applying on the frequency domain spectrum or the effect on the the FID by (pre-)selecting the Full View" window:

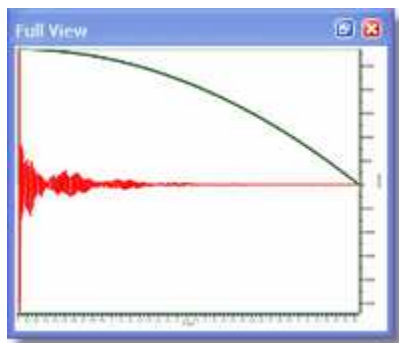

Hanning (Not available in Mnova Lite): Mnova adopts the following generalized equation:

$$f(t) = p + (1 - p) \cos\left(\frac{\pi t}{2T}\right)$$

where T is the acquisition time, and P can be a value from 0 to 1. You can set this parameter on the advanced Functions set of the FT dialog box. If $P = 0.5$ we will have a Hanning function and if $P =$

0.54 we will apply a Hanning function, producing 10 and 20% line broadening respectively. The Hanning window, more correctly called the Hann window and the Hamming window are part of a family of functions known as "Raised Cosines" and also includes the Gaussian Window. These functions, like a cosine bell, have a maximum value; Mnova generally implements these functions with their maxima at zero time. The Hanning Function is sometimes used to reduce aliasing. Aliasing arises when signals are insufficiently sampled (violating the Nyquist Criterion), resulting in spectral folding. It results in peaks appearing at incorrect positions and generally not phasing along with the authentic signals. This arises due to incorrect experimental set up (signals beyond the high frequency end of the spectral width), and the ability to correct for it after acquisition is useful indeed.

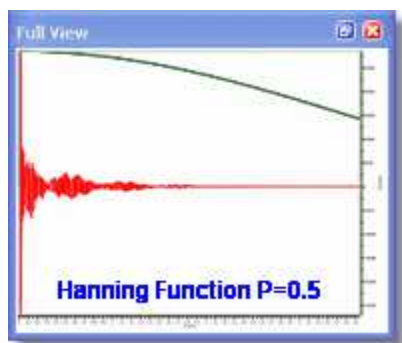

Convolution Difference (Not available in Mnova Lite): This weighting function multiplies the FID by :

$$W(t) = 1 - e^{\left(-0.5t\pi \frac{LB}{SW}\right)}$$

where LB is the line broadening and SW is the spectral width in Hz. You can also access this function from the scroll menu of the FT icon where you will be able to set the value of LB .

Linear Ramp (Not available in Mnova Lite): This command is used to multiply the data points of the FID by an increasing linear ramp, resulting in the first derivative of the Fourier transformed spectrum { $d(\text{intensity})/d(\text{frequency})$ }. This emphasizes the faster rising parts of the spectrum at the expense of SNR. If the initial spectrum had an excellent SNR this function can dramatically improve resolution. Mnova will soon offer derivative performed using wavelet processing which produces even better spectra.

This weighting function gives *more weight* to the end of the FID, amplifying the noise (decreasing the sensitivity), and for that reason we recommend its use only in combination with another function which gives more weight to the beginning of the FID (increasing sensitivity). In practical terms, add the ramp function to a spectrum that has already been windowed by, for example the EM function for 1D or the sine-bell function for a 2D in order to improve the selectivity.

8.4.6 Truncation

Truncation: This technique causes part of the time series, from a given time onward to be set to zero. For convenience Mnova truncates the time series after a given number of acquired points. The user may access this function either via the menu Processing/Apodization etc or via the FT icon scroll menu in the same manner.

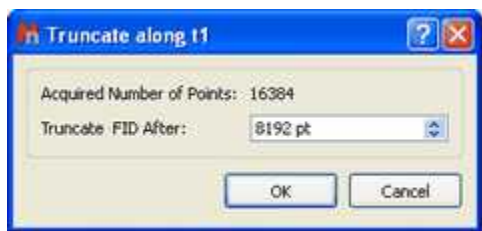

This technique may be used to shorten the acquisition data time series. If the FID, for example, decays to zero in 0.5 seconds and the acquisition time was 2 seconds, the FID consists of 25% signal and 75% noise. Since both 0 and a 90 degrees phase shifted spectra are collected a time series data length of twice the FID time is required for maximum information content. Truncating the FID at about 1.0 second will reduce the amount of storage required with no data loss. At a later time Zero Filling may be used to cosmetically adjust the spectrum's appearance.

This tool is used when the acquisition time has been set much longer than the FID, resulting in the acquisition of a long period of signal-free noise. Truncation sets the signal free latter region of the time-series to zero. This does NOT amount to zero-filling, and the appending of zero-s to twice the original number of acquisition points will still reveal the intrinsic resolution.

Here you can see an example of truncated FID:

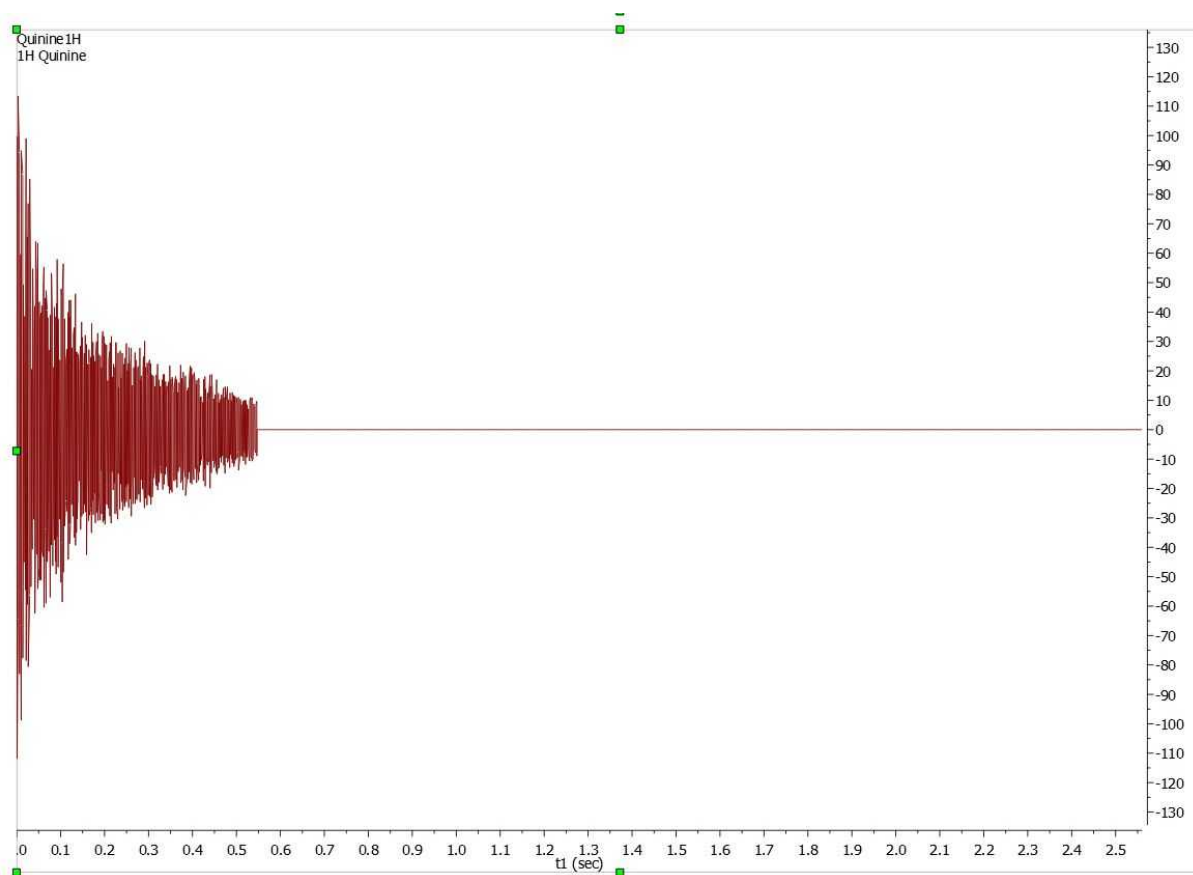

8.4.7 Zero Filling and Linear Prediction

Zero Filling: This option can be used to set the size of the Fourier Transform. It can be used either to increase the digital resolution or to truncate the FID. When the time-domain signal is subject to a FT,

the resulting spectrum is represented by a set of data points (by joining the points it is possible to plot the spectrum as a smooth line). As a Fourier transformation preserves the number of data points, if we take the original FID and add an equal number of zeroes to the end of it, the applicable spectrum will have double the number of points, increasing therefore the 'apparent' digital resolution of the spectrum. The zero filling process is equivalent to a frequency-domain interpolation. This command is available in the 'FT' icon scroll down menu, as shown below.

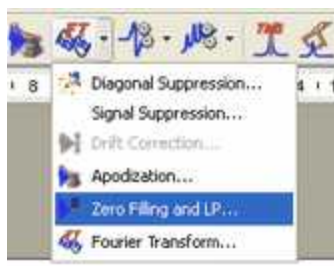

Just select the required number of points (only powers of 2 are allowed) and click 'OK':

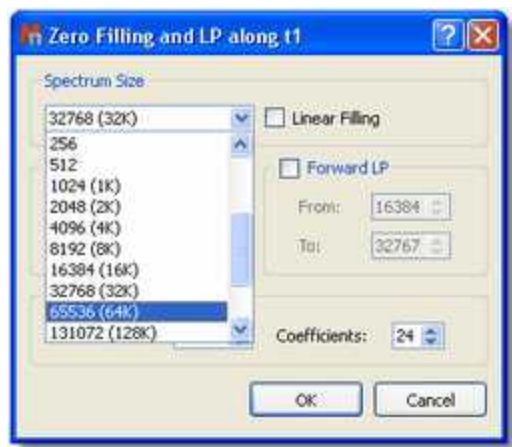

In some cases, the FID does not fulfil the requirement of the number of data points corresponding to an entire power of 2. In these cases, Zero Filling must be applied to the immediately higher entire power of 2 for FT to be possible. Mnova will automatically carry out this Zero Filling when the number of data points is not an entire power of 2. By default, Mnova proposes a duplication of the original number of FID data points. For example, if the FID has 16384 data points (or a number of data points between 16385 and 32768), the Zero Filling open dialog would show us the value of 32768 (32K) data points, which indicates that Mnova will add up to 16384 data points at the end of the FID.

Linear Prediction (Not available in Mnova Lite): Linear prediction is a mathematical procedure where a missing part of a FID can be constructed in order to increase the digital resolution of the spectrum; it is a tool which examines the free induction decay, extracts a set of coefficients, and extrapolates, either forward or backward, to predict what the data would have had it been collected. This is a potentially valuable technique for extraction of useful information from marginal data.

Linear prediction is based in this fundamental principle: each value in the time series can be represented as a linear combination of the immediately preceding values. Mathematically, the basic LP equation postulates:

$$d_m = \sum_{p=1}^p a_p d_{m-p}, m = p, \dots, N-1$$

where a_p are the LP Coefficients and the number 'p' corresponds to the order of the prediction. Thus, it is possible to extrapolate the series beyond the point N . This equation is known as *Forward Linear Prediction* (extrapolates forward, predicting the new values from the older ones).

Backward Linear Prediction will be represented in the following equation:

$$d_m = \sum_{p=1}^P b_p d_{m+p}, m = 0, \dots, N - P - 1$$

This command is available in the same menu as zero filling. If you need to repair the baseline distortions (due generally to the first points of the FID) you have to tick Backward LP and select the limits; this will predict the first points of the FID.

Forward Linear Prediction is a better alternative to correct the last part of the FID than *zero filling*; this will extrapolate the FID in the direction of the advance, predicting the new data points from the older. If you select 'Linear Filling', a Forward LP from the end of the original FID up to the number of points defined in the 'Spectrum size' combo box, will be executed. You can also set the number of Basis Points and Coefficients of the algorithm that you want to use for Linear Prediction.

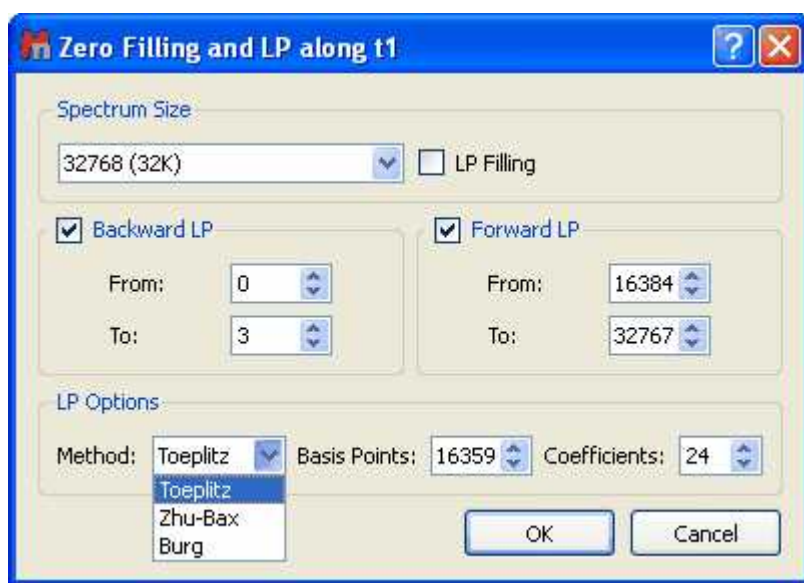

Method: Linear Prediction is extremely useful in 2D NMR as a way of reducing the acquisition time or increasing the quality of already existing data sets. Also, in 1D NMR it is useful when the FID has not decayed to zero before experiment completion. This often happens when working with slowly relaxing nuclei (such as quaternary carbons, in ^{13}C -NMR) and in experiments with a wide ppm area (spectral width).

One of the most common causes of the corruption of the first data points of the FID is the security time or *pre-scan delay* (time which exists between the pulse and the beginning of the acquisition) which in many cases may not be enough to allow the detector to recover fully from the effect of the pulse.

Our LP implementation is based in a very fast orthogonalization of Toeplitz matrices which is one of the fastest implementation of LP algorithms used in NMR. It gives very good results with phase sensitive data, in particular with HSQC and related spectra. However, it does not work very well with spectra in magnitude (or non phase sensitive) mode. In fact, Toeplitz method does not make it

possible to reflect the roots of the LP coefficients within the unit circle because the resulting new LP coefficients get worse.

With such problems in mind, we decided to try the well known Zhu-Bax approach. In short, the algorithm calculates the forward and backward LP because in theory they should be identical. However, in presence of noise they are different. Zhu and Bax proposed to reduce the contribution of the random errors induced by noise by simply averaging the two sets of coefficients (fwd & bwd). Finally new roots are computed based on the average coefficients.

Of course, Zhu-Bax LP is slower than the Toeplitz method (mostly because of the roots calculations) but if the number of coefficients is small (e.g. < 8), it's relatively fast.

The Burg method is probably the first implementation of Linear Prediction developed by John Burg many years ago and it was extensively used in geophysics, but in general, should not be used with NMR data.

Coefficients: number of theoretical sinusoids. The number of the coefficients should be equal to the number of peaks in the FID in an ideal case. By default Mnova sets the number of coefficients according to:

$$\text{Number Of Coefficients} = \text{points in the spectrum}/16$$

Basis Points: they are the number of 'good' experimental points to be entered in the calculations. The number of basis points should be at least twice or three times greater than the number of coefficients.

8.4.8 Drift Correction

Drift Correction: The DC (Drift Current) component is the zero frequency (F_0) of the spectrum, which is proportional to the sum of all data points in the FID; if F_0 is different to zero; a glitch signal (spurious peak) will appear in the centre of the spectral window. Both real and imaginary parts of the FID should decay to zero at the end of acquisition, but sometimes this "zero" is different and the offset may not be the same for both channels. Mnova corrects this spurious peak by default prior to Fourier Transform, although you can find and customize this tool (by selecting the number of tail points of the FID to determine the mean DC level) in the open dialog of 'Fourier Transform'; as you can see below:

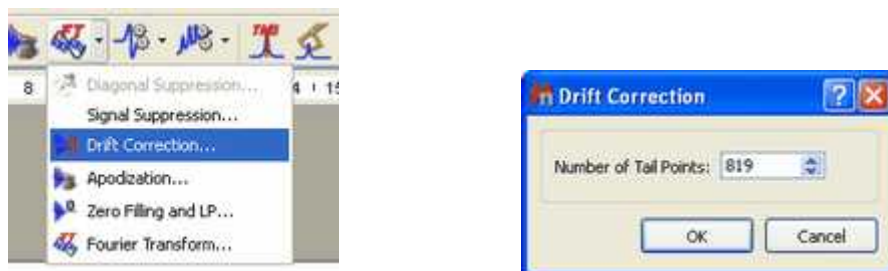

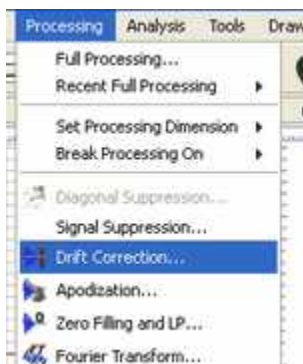

You can also find this option by following the menu item 'Processing/Drift Correction':



8.4.9 The FT Command

Fourier Transform: The FT command transforms the acquired data of the current data set, which may already have been processed using a filter function. Depending on the way a spectrum was recorded (e.g. simultaneous vs sequential sampling, quadrature settings, etc) the FT can be real or complex and some additional pre-processing may be required. All these options can be set in the

Fourier Transform dialog box, which will appear by clicking on the '**Fourier Transform**' icon  or by following the main menu item 'Processing/Fourier Transform'.

If you click on the F1 icon  (to select the indirect dimension) and then on the FT icon , you will obtain the following dialog box:



Protocol: This option corresponds to the data shuffling algorithm required to process phase sensitive 2D spectra

None: If your spectrum is not phase sensitive, then the correct choice is: **none** protocol. (i.e. when only the magnitude or power spectrum is to be obtained). It corresponds to the simpler 2D experiment in which a scan is collected with a 0° pulse of the mixing pulse, and then another is collected with a phase of 90° and finally combined before to storage in memory.

Bruker: QF mode

Varian: p-type: f1coef='1 0 0 -1'

n-type: f1coef='1 0 0 1'

Phase sensitive: this kind of experiments are used to get higher resolution and more information out of a 2D dataset. You can obtain better resolution and better S/N ratio by generating quadrature phase detection in the second dimension, but at the expense of longer acquisition times and larger datasets.

Echo-antiecho: You should select this option for phase modulated experiments with gradient pulses (used for coherence pathway selection), where pairs of slices are added and subtracted to generate complex "fids" in the indirect dimension. Each slice contains both sine and cosine terms in t_1 . This means that the data must be handled differently from hypercomplex data, in which odd numbered slices contain only cosine t_1 terms, and even numbered slices contain only sin t_1 terms.

Bruker: ECHO-ANTIECHO
Varian: f1coef='1 0 -1 0 0 1 0 1'
f1coef='1 0 -1 0 0 -1 0 -1'

Swap Halves (Quadrature): the negative frequencies are distinguished from the positive ones by the detection and summation of the in-phase and 90° out-of-phase magnetizations (two-channel mode).

Mirror Image (Invert): this command performs a complex-conjugate of the data before the protocol and FT is applied. It is used to generate a mirror image of both the real and the imaginary parts of the spectrum, with respect to a vertical line positioned in the middle of the spectrum; i.e., the spectrum is reversed.

You will need to check/uncheck this option when you get the mirror image of your expected spectrum along any dimension.

Most Varian spectra will require this option to be checked whilst most Bruker spectra will not except those experiments acquired using the TPPI scheme.

Real FT: it allows to execute a real Fourier Transform as opposed to the conventional Discrete Fourier Transform (normally, this is only necessary for Bruker spectra acquired by sequential mode). Modern spectrometers acquire spectra in a way which avoids the use of this option.

Typically, quadrature detection involves the use of two digitizers (ADCs) to sample at the same time the real and imaginary components of the signal. However, quadrature detection can also be done with a single digitizer using the Redfield trick in which the real and imaginary parts are sampled sequentially in time but doubling the sampling rate in order to get the same spectral width. In this case, a Real Fourier Transform is needed. This option is typically used in 1D Bruker spectra acquired in sequential mode (QSEQ) and also it is also necessary along f_1 for 2D spectra acquired in TPPI mode.

8.5 Phase Correction with Mnova

NMR spectra are usually represented in absorption mode, which offers a greater resolution and proportionality between the integral of peaks and the number of nuclei which cause the signal, in comparison with other representations such as dispersion mode, magnitude or power of the spectrum. Nevertheless, the absorption and dispersion curves are often mixed, giving rise to curves which lose the original symmetry. This problem, combined with other deficiencies, such as delays between the initial pulse and the beginning of data acquisition, cause a phase shift which varies linearly with frequency. This phase errors can be easily rectified in software by applying a lineal combination of the real and imaginary components of the spectrum in order to obtain pure phase lineshapes.

This correction is composed by a *frequency independent* parameter, or zero phase correction (α) and a first order phase correction (β) or *linear dependent* on the frequency parameter:

$$\text{Re}'_k = \text{Re}_k \cos\left(\alpha + \frac{k}{N}\beta\right) - \text{Im}_k \sin\left(\alpha + \frac{k}{N}\beta\right)$$

$$\text{Im}'_k = \text{Re}_k \sin\left(\alpha + \frac{k}{N}\beta\right) + \text{Im}_k \cos\left(\alpha + \frac{k}{N}\beta\right)$$

where $k = 0, \dots, N-1$; Re_k and Im_k are the real and imaginary components of the data points (k), Re'_k and Im'_k are the new components after correction and N is the total number of points.

Mnova implements both manual and automatic **Phase Correction algorithms**.

The Phase Correction scroll menu is located on the arrow immediately to the right of the '**Phase Correction**' icon.



The software implements three algorithms for automatic phase correction, which can be applied both to 1D or to 2D data sets, and a manual algorithm, which allows for very easy, eye driven, real time zero order and first order phase correction. Once the user selects a Phase Correction method, Mnova will store it for future uses, highlighted with a black square.

Automatic Phase Correction

Mnova gives the user the choice between four auto-phasing algorithms for higher flexibility. Indeed you can select more than one algorithm at the same time and the algorithms will be applied consecutively:

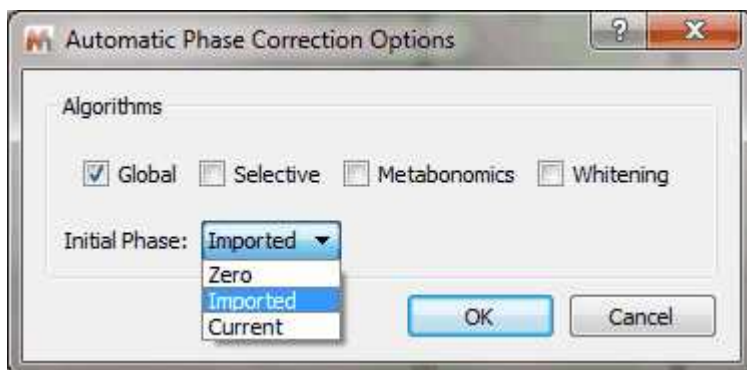

The user will be able to select the initial phase correction to run the Automatic Phase Correction algorithm (Zero, Imported, Current). By default is the imported phase from the spectrometer (you can change the default Phase Correction from the 'Edit/Preferences/NMR/Import' menu):

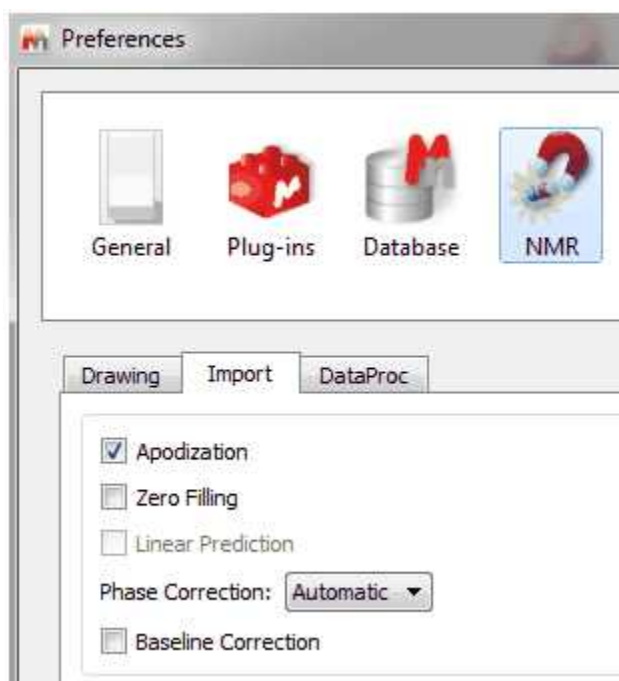

Global method: This method automatically finds phasing parameters (α and β or PH0 and PH1) using an iterative process in which the intensity of the lowest point in the spectrum is optimized. This method is not appropriate for experiments like DEPT or APT, where we can find both positive and negative peaks, but is highly efficient for most ^1H spectra. However, it is sensitive to bad baselines and low Signal/Noise ratios. Mnova will automatically execute this Phase Correction.

You can see below the effect of an automatic phase correction on a ^1H -NMR spectrum with a very bad phase:

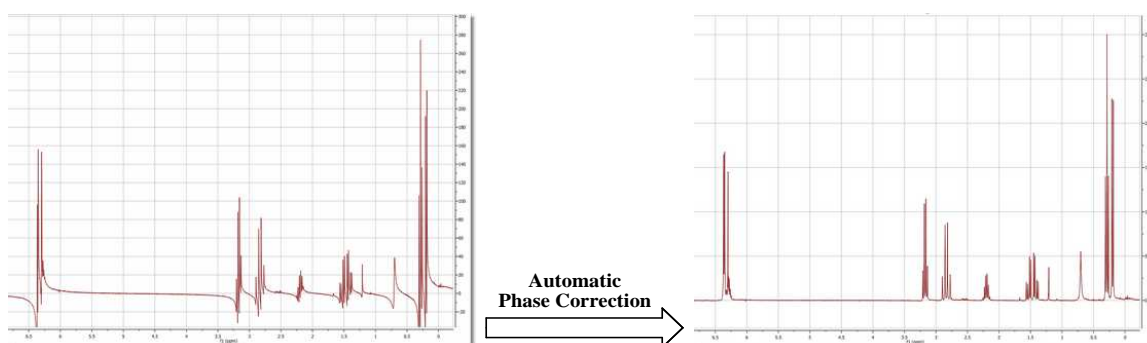

Selective Method (Not available in Mnova Lite): This automatic method is intended for spectra containing negative and positive peaks (e.g. DEPT, APT, etc) or in the presence of baseline distortions. Mnova creates a list of the highest peaks in the spectrum and then uses symmetrization criteria to obtain the optimal phasing parameters (α and β).

Mnova will automatically execute the better Phase Correction in each case prior FT.

Metabonomics. A new Automatic phase correction algorithm optimized for biofluid-like spectra (Not available in Mnova Lite).

This algorithm is an extension of the standard automatic phase correction algorithm optimized to deal

with Metabonomics-like spectra in which most of the signals are concentrated towards the center of the spectral width. In addition, it can also efficiently deal with situations in which a dispersive peak is present in the center of the spectrum, as is usually the case with water in urine samples. It is also tolerant to small first order baseline distortions (including V-shaped baselines).

The figure below shows a spectrum of rat urine with the standard automatic phase correction algorithm applied to the top spectrum and with the new automatic phase correction algorithm applied to the bottom spectrum.

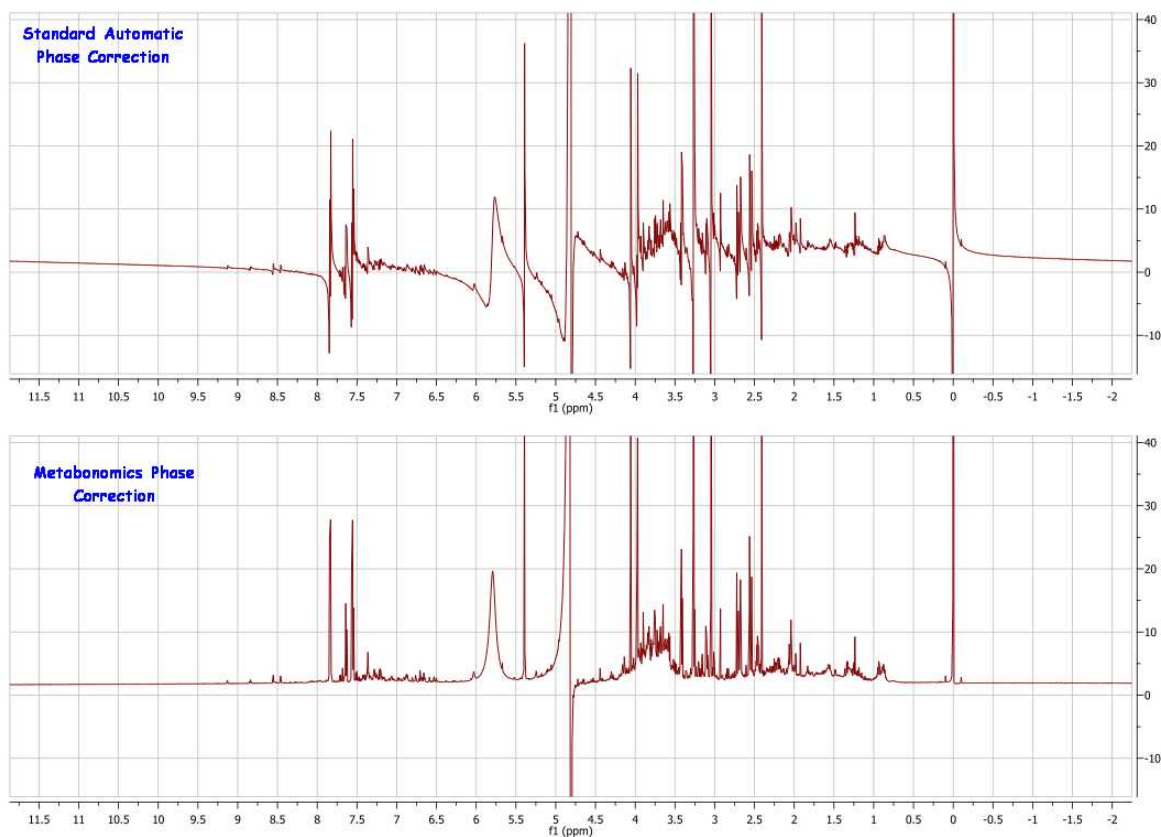

This algorithm is not restricted to Metabonomics spectra, as it is also good for any other spectra satisfying the two conditions outlined above. For example, the figure below shows the difference in performance between the standard automatic phase correction algorithm (top) and the new one (bottom). In this case, the water signal cannot be perfectly phased and thus a standard automatic phase correction fails. The new method yields a much better result as can be seen in the figure.

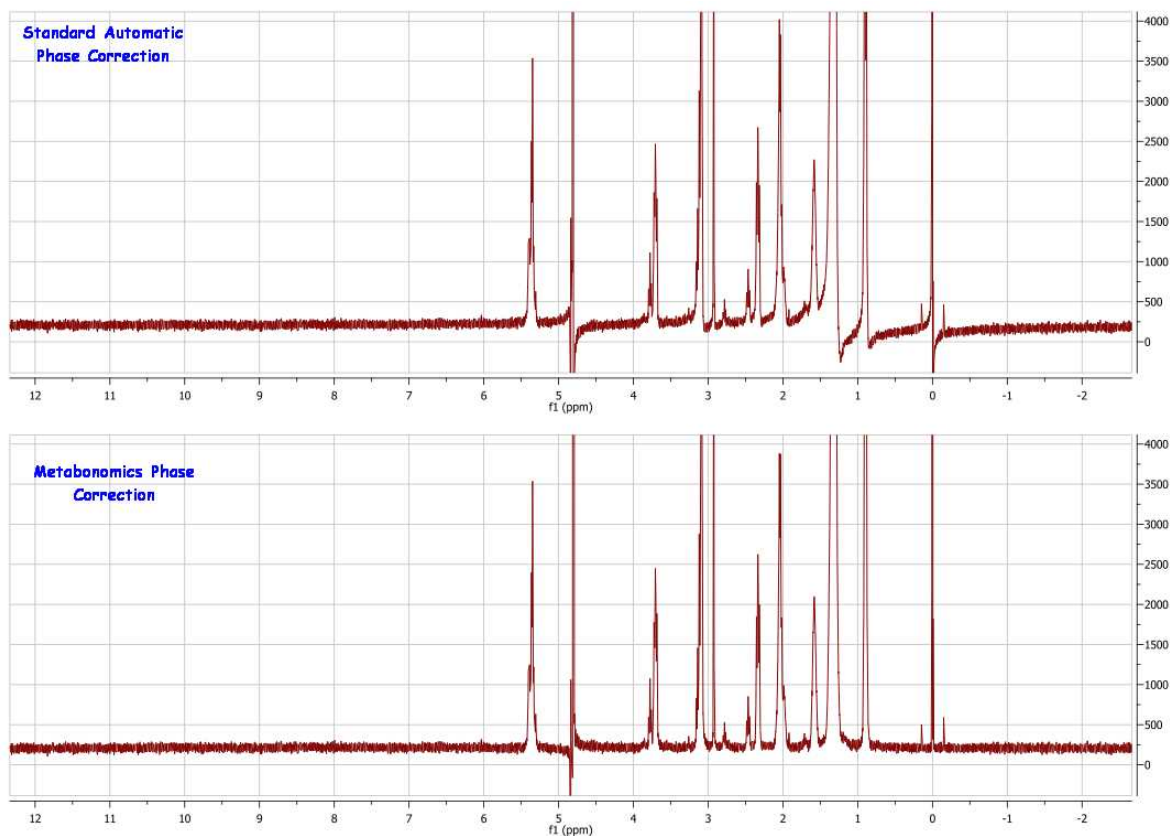

Whitening (only for 1D): A method for fully automated phasing of Fourier transform NMR spectra based on a combination of the whitening and the metabonomics method. First of all, the whitening method is applied in order to get good starting phase correction parameters even in spectra that have both positive and negative peaks. Then the most negative peaks are removed and a simple baseline correction is applied. Finally, the metabonomics method is applied.

Manual Phase Correction (shortcut: Shift+P): The manual phase correction is based in finding the appropriate α and β phase correction parameters. This option is very easy to use. Just select 'Manual

Correction' in the 'Phase Correction' scroll down menu  or via the menu 'Processing/Phase Correction/Manual Correction'.

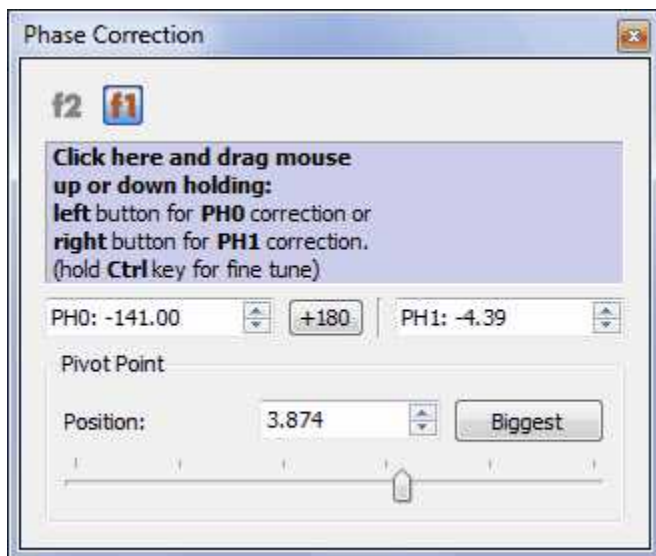

Once the dialog box is open, establishing a pivot for the adjustment is very easy and intuitive, by just using the scrolling bar provided. The pivot will maintain an invariable phase in the peak where it is located, while a first order correction is carried out. Click on the *Biggest* button to put the pivot point on the biggest peak of the currently displayed spectrum region. You can also place it in a position of your choosing by clicking and dragging the pivot point marker or by selecting the desired position in the edit box:

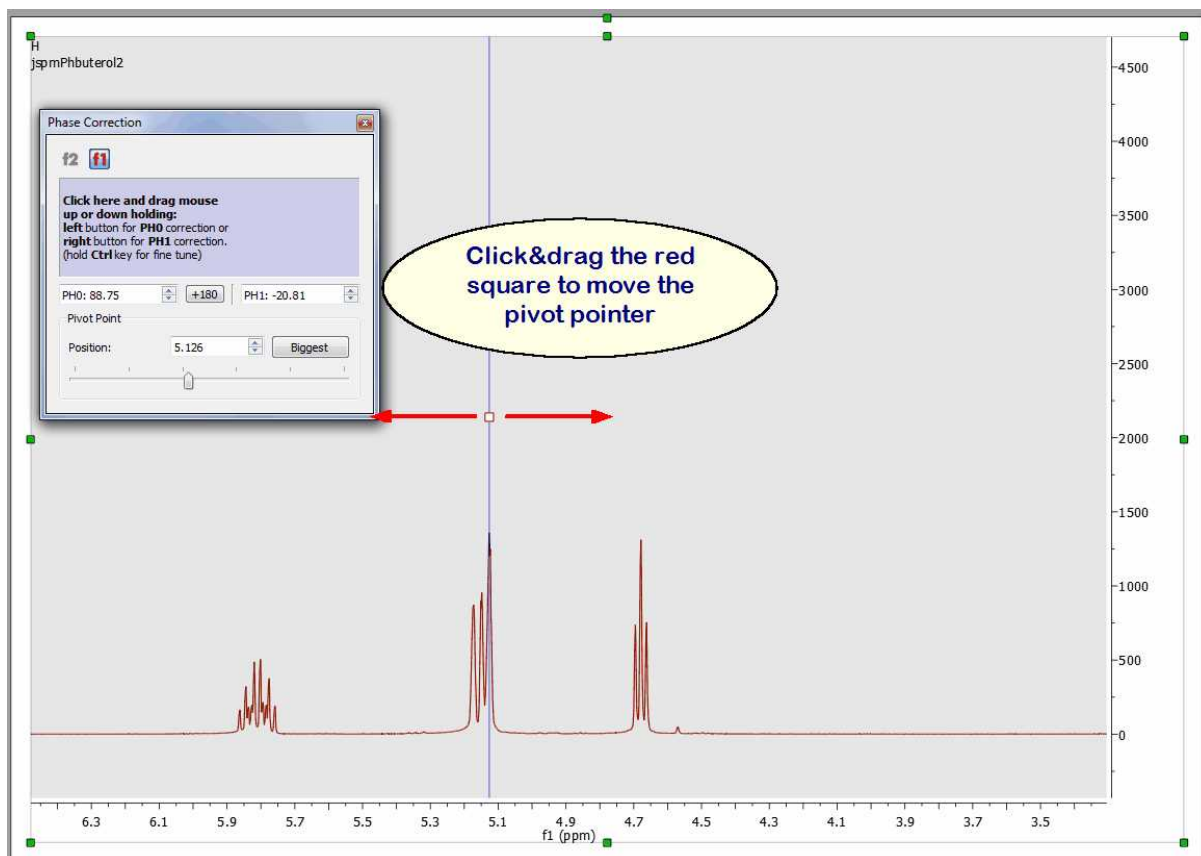

Next, correct the zero order phase (by clicking with the left mouse button anywhere on the *Phase*

Correction dialog box and dragging the mouse up or down without releasing to correct the phase of the reference peak) and finally do exactly the same whilst right clicking to correct the phase of the remaining peaks (*First Order Phase Correction*). For a fine tuning, hold the 'Ctrl' (or cmd key in Mac) key while dragging the mouse.

You can use the 'Ctrl' key in a Mac machine to simulate the right mouse button in order to phase PH1.

The Phase Correction dialog box incorporates two edit boxes to introduce the values of α (PH0) and (PH1) β for the correction and a button to apply $+180^\circ$ to PH0



Please note that the Phase Correction dialog is **modeless**, so you will be able to use any other tool (i.e. zooming) whilst you are applying the correction.

The power and speed of the manual phase correction algorithm implemented in Mnova becomes obvious when correcting the phase of 2D experiments. This can be done directly on the 2D matrix, and the phase can be quickly corrected along one and then the other dimension (Note that for all operations in 2D NMR, the active dimension is indicated by the '**f1**' and '**f2**' icons in the upper toolbar).

Phase Correction for 2D-NMR spectra

The phase correction feature for 2D NMR spectra includes in addition two powerful algorithms which can be accessed via the 'phase correction scroll down' menu:

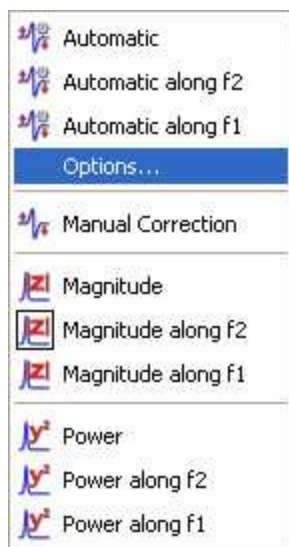

Clicking on 'Options' will display a dialog box which will allow you to select the desired algorithm:

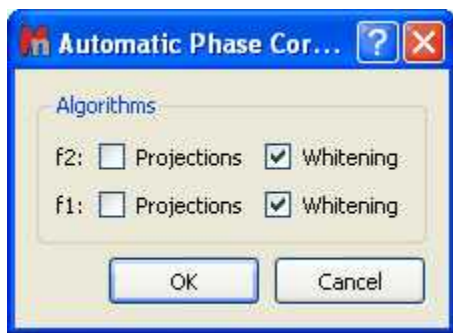

The **Projections** algorithm will calculate the 1D projections of the 2D-NMR spectrum and will apply a 1D automatic phase correction over both projections. These values will be used as initial values for the 2D adjustment when you have selected also the **Whitening** algorithm. If you only select the Projections algorithm, only 1D phase corrections values (of the projections) will be used for the 2D correction.

This method involves the calculation of the internal projection as the sum of all columns (or rows) in the 2D matrix. In the case of homonuclear correlation spectra, the projection is analogous to the diagonal. The phase correction calculated by an automatic 1D algorithm can be used as a rough estimate of the phase correction of the whole 2D matrix. This method is satisfactory in the case of homonuclear correlation, but inapplicable in the case of an edited HSQC (with both positive and negative peaks and much more noise).

The **Whitening** algorithm is based on the *whitening* concept formulated as the 'maximization of the number of white pixels into a bitmap that corresponds to the spectrum'. This process of maximization can be factorized along the individual axes of the spectrum and this property makes the method robust and fast. It employs a statistic measure based on a large number of spectral data points and, for this reason, is very tolerant to low SNR and local artifacts. The algorithm can efficiently phase either homonuclear or heteronuclear experiments and, unlike other previous methods, it can also process automatically spectra containing positive or negative peaks so that it is not necessary to deal with individual or special cases.

NOTE: After having applied a baseline correction in a 2D dataset, the manual phasing will be grayed out. To undo the baseline correction, follow the menu "Processing/Processing Template" and turn off the Baseline Correction for either dimension, click on OK and you will be able to correct the phase manually.

Alternatives to Phase Correction. Magnitude and Power.

There are other easier alternatives if you only need positive peaks: representations in 'Magnitude' or in 'Power'.

Magnitude: It determines the representation of the final spectrum. If this option is checked you will see the absolute part of the spectrum; if it is unchecked you will only see the real part. As a spectrum is composed of complex vectors, its magnitude or module ***M*** can be calculated by the following expression:

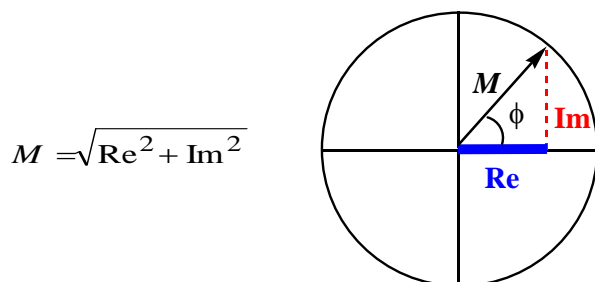

To represent the spectrum in *Magnitude* with Mnova, just open the 'Phase Correction' dialog box by clicking on the 'Phase Correction' scroll menu  and then select 'Magnitude' (as you can see in the capture below) or via the 'Processing/Phase Correction/Magnitude' menu.

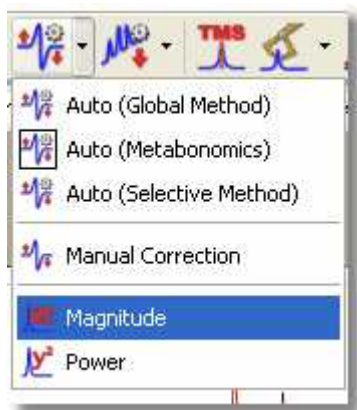

Mnova will replace the real part of the spectrum by the magnitude (M) of each complex vector and the imaginary one by the phase angle of the vector ϕ , thus allowing reversal of this option. That is to say:

$$\text{Re}'_i = M = \sqrt{\text{Re}_i^2 + \text{Im}_i^2}$$

$$\text{Im}'_i = \arctan\left(\frac{\text{Im}}{\text{Re}}\right)$$

Power: the power of the spectrum (P) is defined as the square of the magnitude:

$$P = M^2 = \text{Re}_i^2 + \text{Im}_i^2$$

To represent the power of the spectrum, open the '**Phase Correction**' dialog box by clicking on the '**Phase Correction**' scroll menu  and then selecting '**Power**' or via the 'Processing/Phase Correction/Power' menu. The '**Power**' as well as the representation of the '**Magnitude**' are reversible options.

The '**Magnitude**' representation produces an increase in linewidth, whilst the '**Power**' representation distorts the intensities of the peaks:

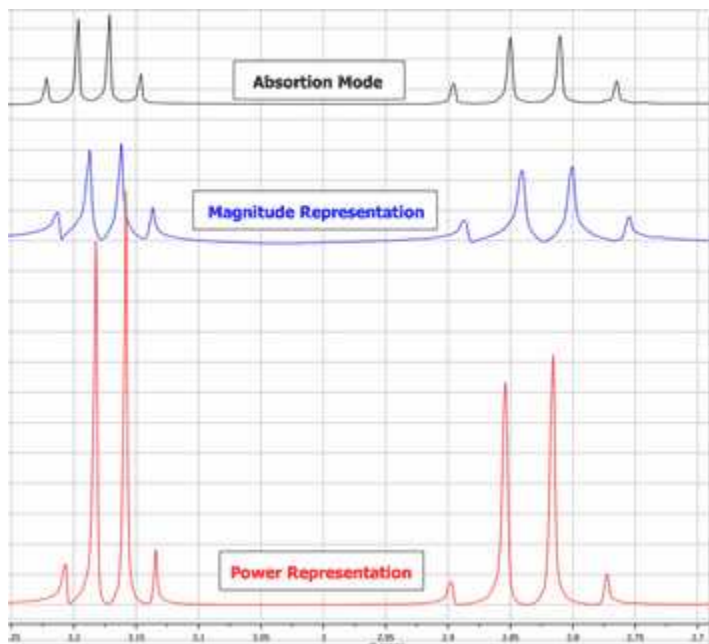

8.6 Baseline Correction with Mnova

The baseline of a monodimensional spectrum is the theoretical line which connects the spectrum points which are not peaks (nor artefacts). When this baseline is not flat and/or it is offset from zero, many problems arise. Quantitative measuring of high resolution NMR demands a precise signal integration. These integrals are very sensitive to slight deviations of the spectrum baseline. The deviations are often due to a distortion of the first points of the FID (see First Point Correction and Linear Prediction). The origin of this kind of distortion is often the *transmitter breakthrough* effect (the detector needs a period to recover from the pulse effect in spite of being switched off when the pulse is applied). This could distort the first points of the FID producing a vertical displacement of the baseline, or even undulations, and, consequently, errors in the signal integrations. You can use a 'Backward Linear Prediction' to solve this problem on the time domain, or a 'Baseline Correction' as a better alternative.

Modern spectrometer hardware uses oversampling and digital signal processing to improve the baseline, but some undesirable broad signals arise from real sources. Thus, a more general solution would employ an efficient post processing baseline correction in the frequency domain. In fact, this is the most common approach found in NMR literature.

2D spectra suffer from baseline problems which may cause difficulties in the visualization of the full data set at once, since the signals of interest may be smaller than the baseline distortions; specially for phase-sensitive experiments and when a large residual solvent signal distorts the baseline. Thus, it turns out that baseline correction is a very important processing step to obtain good quality spectra.

Baseline correction is an area in which Mnova is particularly strong. The software implements Manual Baseline Correction and several automatic Baseline Correction algorithms (Polynomial Fit, Bernstein Polynomial Fit and our in-house developed algorithm, the Whittaker Smoother, which gives exceptional results in 1D and 2D data sets, is extremely fast and in the vast majority of cases fully automatic and is tolerant to varying linewidths along the same spectrum and to poor signal to noise ratios).

The Baseline Correction interface is also very simple. Just click on the '**Baseline Correction**' icon



and this will execute a 'Full Auto' Baseline Correction, if you click on the scroll menu, the Baseline Correction dialog box will open and give the user a choice between the algorithms available, allowing control of certain parameters depending on the algorithm.

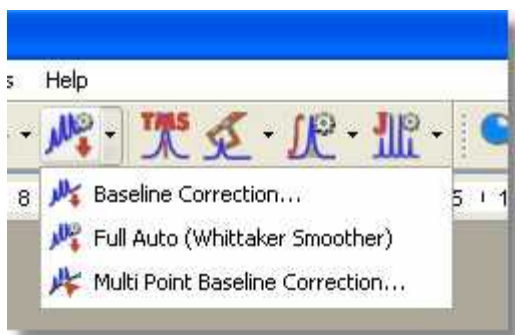

Novelty:

Using **Mnova**, you will be able to adjust the phase after baseline correction, because Mnova will not discard the imaginary part of the spectrum after a baseline correction.

THE BASELINE CORRECTION DIALOG BOX



As a simple example of baseline correction, in the figure below we show a 1D spectrum in which the baseline distortions are evident. Note that the baseline not only deviates from the 0 level (represented by the gray dotted line), but it does also contain a significant rolling. You can choose the parameters of the baseline correction by dragging the parameter control (in the red circle in the 'Baseline Correction' dialog box above) or by introducing the values of the parameters directly into the edit boxes. You can also select 'Autodetect' if you prefer Mnova to calculate the best parameters for your spectrum.

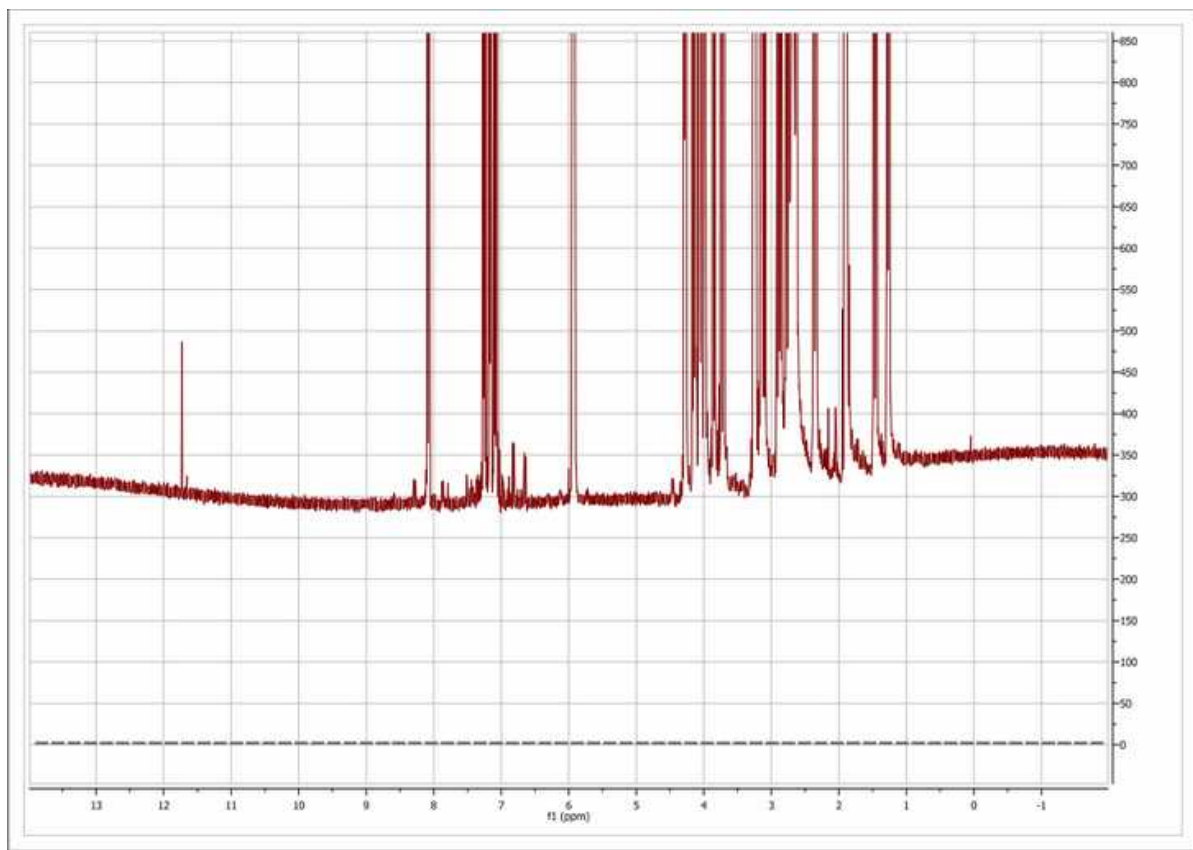

After baseline correction (fully automatic), using the **Whittaker Smoother** algorithm, the baseline becomes perfectly flat as depicted in the figure below

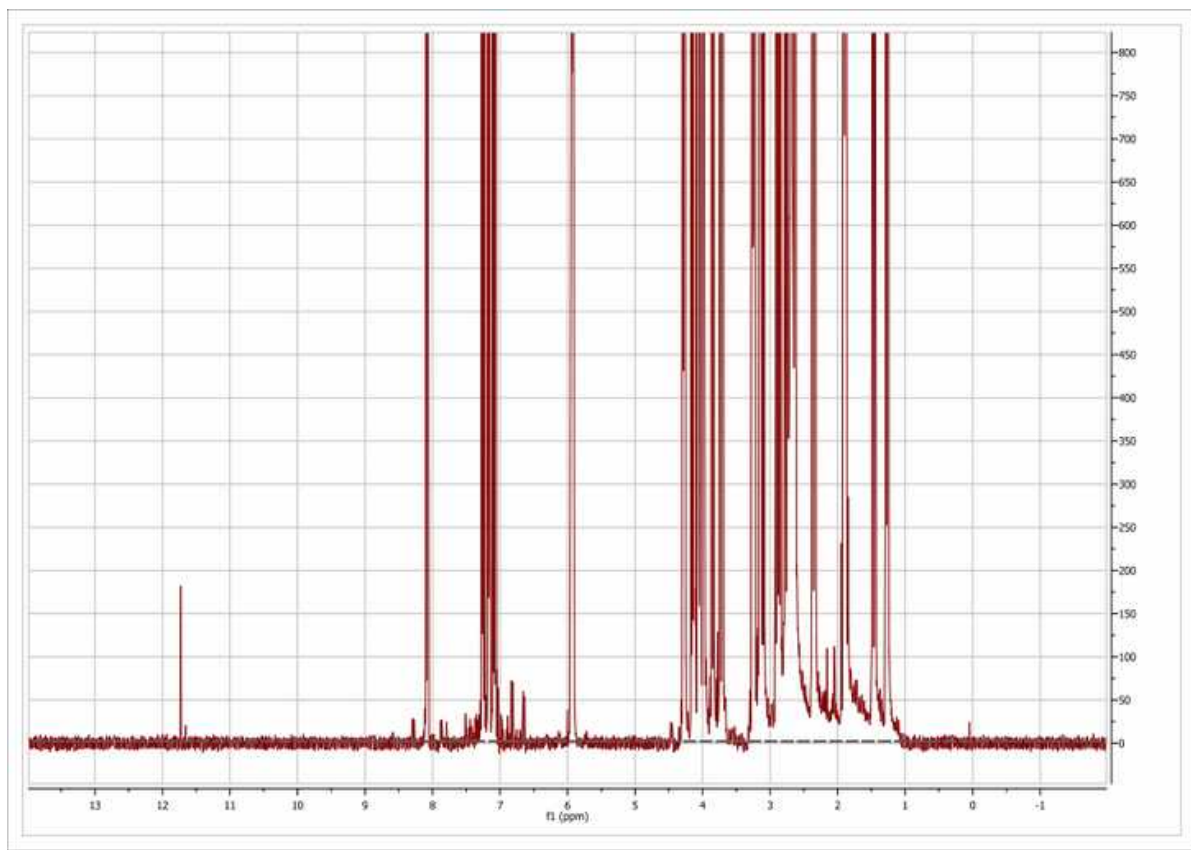

NOTE: It will be possible to draw the baseline by selecting the applicable option in the 'Properties/Grid' dialog box (very useful if you have removed the vertical scale):

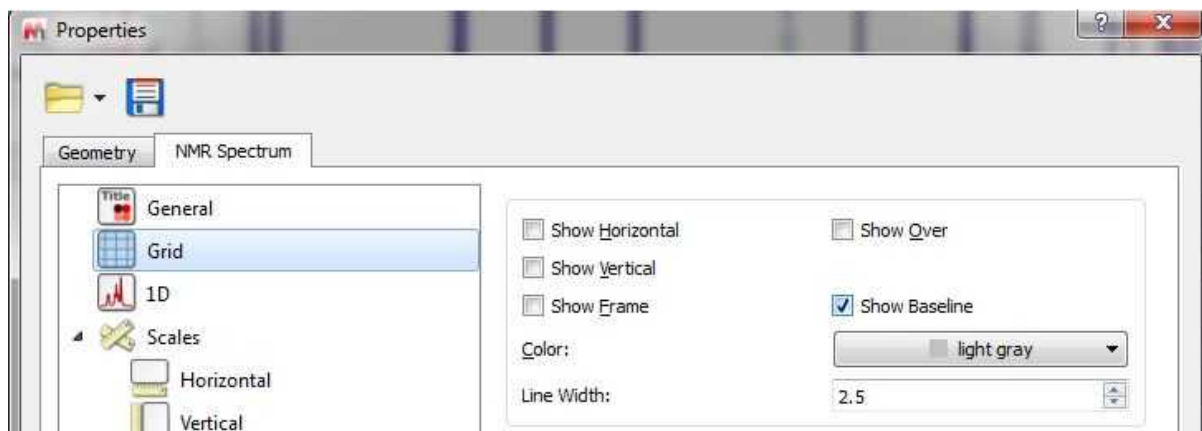

Whittaker Smoother Algorithm: it is a new procedure for automatic baseline correction of frequency-domain NMR data sets which we show to be highly effective on 1D and 2D spectral datasets, and which preserves the range of component line widths which are present in the sample.

The algorithm consists of two independent processes:

1. Automatic baseline recognition (signal-free regions) based on a Continuous Wavelet Derivative transform (CWT) followed by iterative threshold detection in the Power mode domain.

2. A baseline modelling procedure based on the Whittaker smoother algorithm.

Overall, the algorithm has been designed to afford perfect baselines in NMR data sets spanning a wide range of possible baseline topographies and signal-to-noise ratio (SNR) conditions. In most cases, it can be applied successfully without any operator interaction, but further versatility is assured by two parameters which could be adjusted to guarantee an optimum outcome. The procedure can therefore be “tuned” to achieve more accurate baseline recognition of signal-free regions, or to increase smoothness at the expense of spectral fidelity, or vice versa.

You can find more information about this 'in-house' developed algorithm in this reference: Cobas, J.C. *et al. J. Mag. Res.* 183, 2006, 145.

Polynomial Fit: In some cases, the employment of polynomial interpolations offers the advantage of smoothing the corners of each section. The user can adjust the polynomial from first to 20th order as well as the so-called 'Median Filter' (the user can see in **real time** the exact effect of the algorithm by a green line drawn on the spectrum display).

The polynomial used in this interpolation is:

$$Y = a_1 + a_2x + a_3x^2 + a_4x^3 + \dots + a_Nx^{N-1}$$

where a_1 - a_N are the coefficients to be fitted to the baseline and x the coordinates along the spectral axis.

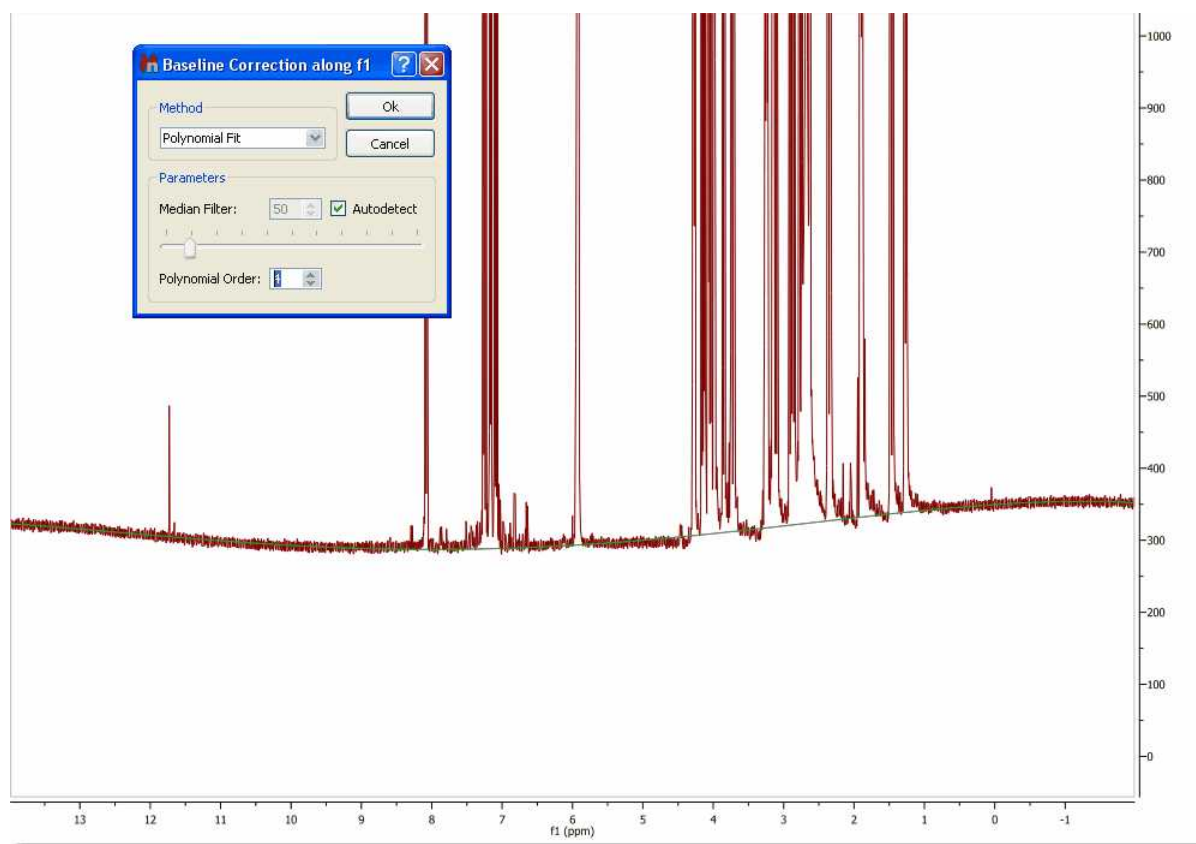

Bersntein Polynomial Fit: This interpolation is defined by the following polynomial:

$$Y = a_1(1-x)^{N-1} + a_2x(1-x)^{N-2} + a_3x^2(1-x)^{N-3} + \dots + a_Nx^{N-1}(1-x)^1$$

The user only needs to select the order of the polynomial (a_1 - a_N) and then click 'Ok', as shown in the capture below:

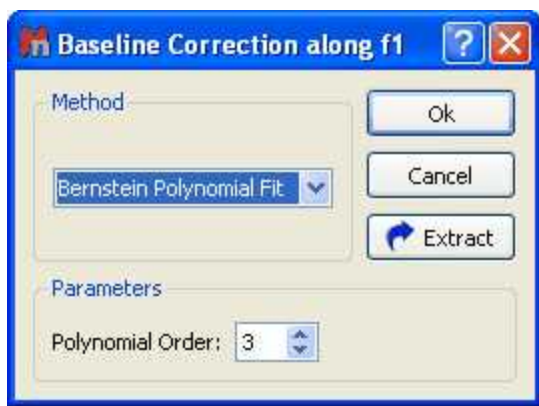

For a 2D example, see the [2D NMR Processing](#) Tutorial.

Please bear in mind that you can extract the baseline correction when you are working with 1D-NMR spectra by just clicking on the 'Extract' button . Once the baseline correction has been extracted, you can use it to correct the baseline of any other spectrum by using the '[Arithmetic](#)' feature. You can see in the picture below that we have applied the previously extracted baseline correction of the sample 'js1pmquin' to the sample named 'STANDARD 1H OBSERVE' by applying a subtraction of the spectrum minus the baseline (Spectrum-Baseline=Spectrum with Baseline Correction).



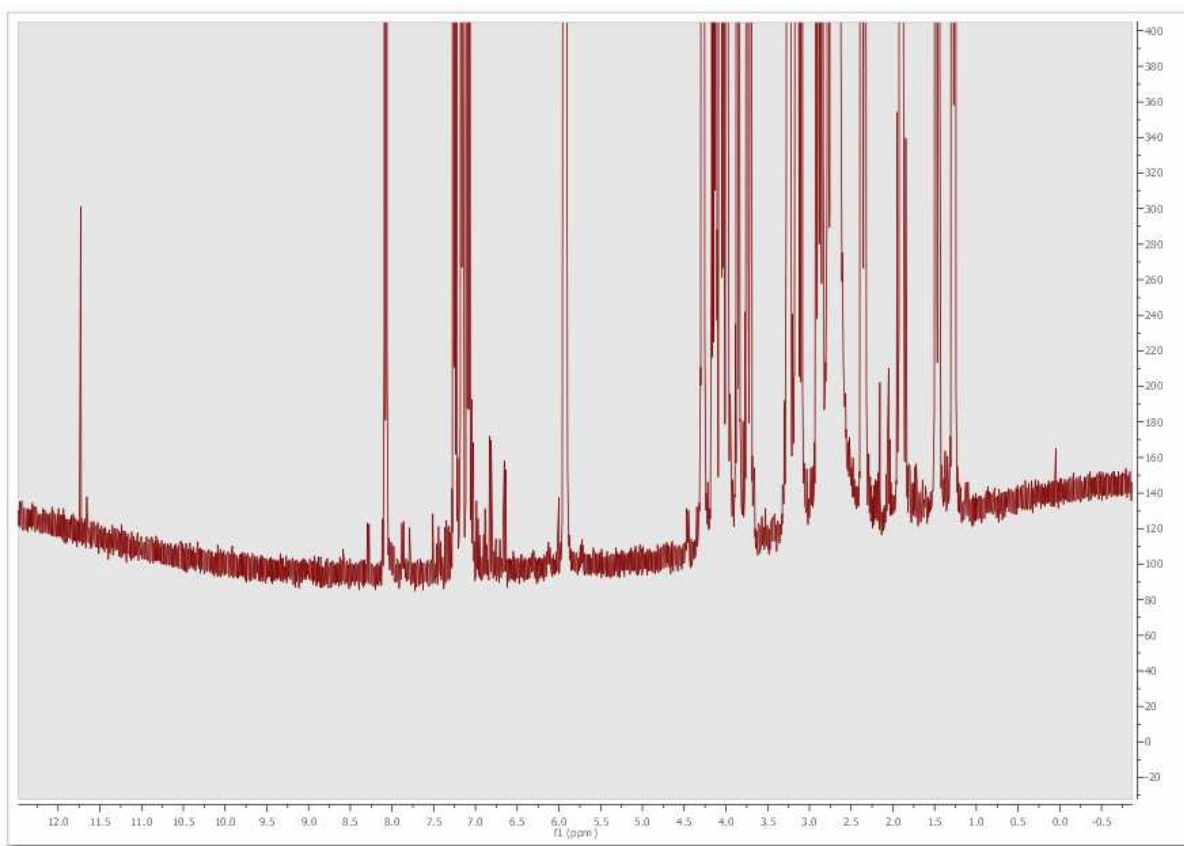

Multipoint Baseline Correction: This method provides a very simple way of modeling the baseline by selecting a well-distributed set of points that fall on the baseline and then interpolating between those points to complete the model. Please keep in mind that this method is not scriptable and can not be included in the Processing templates.

The following spectrum shows significant baseline distortion:

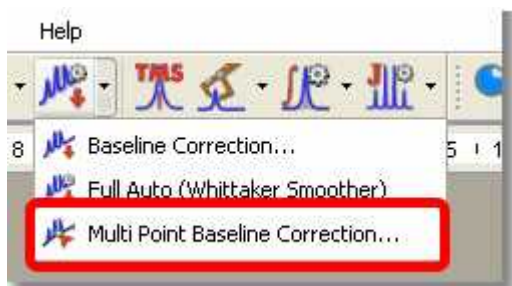

Next, select the 'Manual Multipoint Baseline Correction' in the 'Baseline Correction' scroll down menu:



This will display the 'Multipoint Baseline Correction' dialog box which will allow you to put down points along the baseline (by clicking on the 'Pick Baseline points' button ) to help the program to find the correct coefficients for the baseline correction equation that it will subtract from the spectrum. If you want to remove any undesired pick, just double click on it (click and drag if you want to change the location of the point).

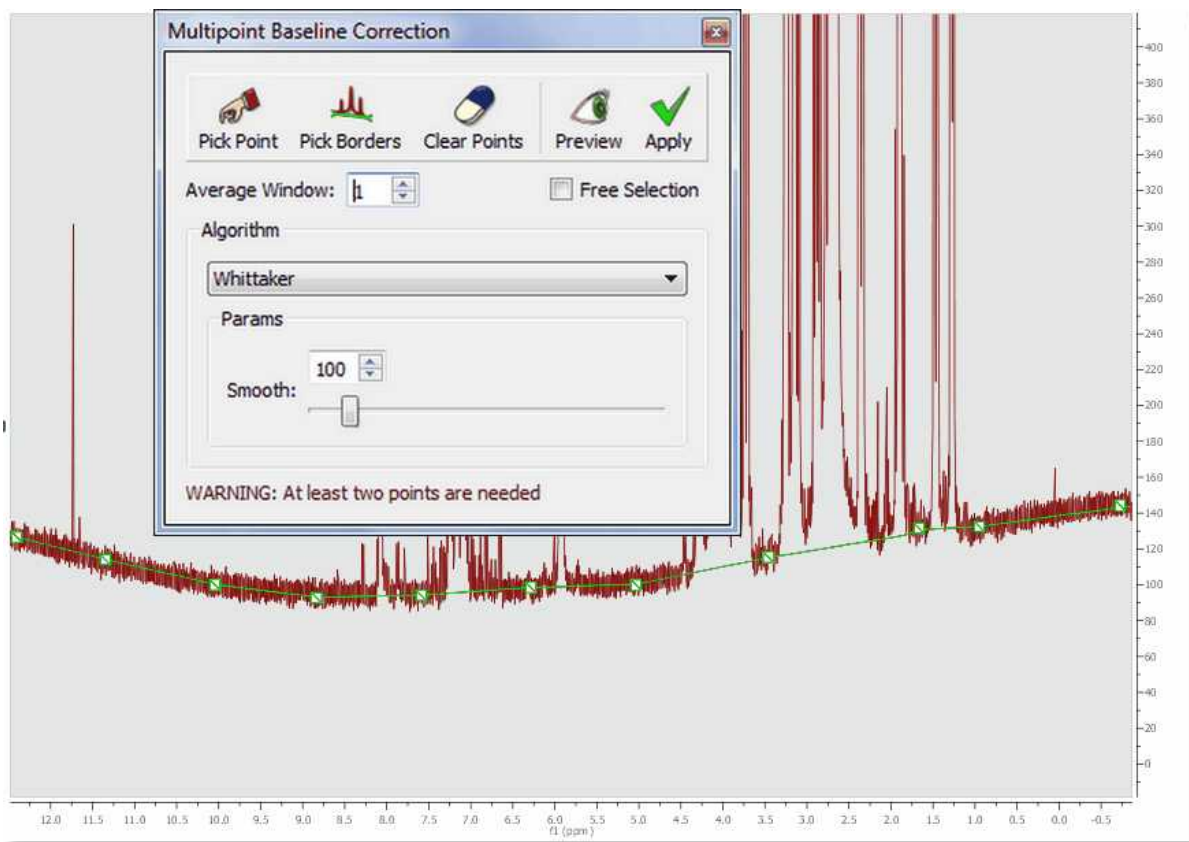

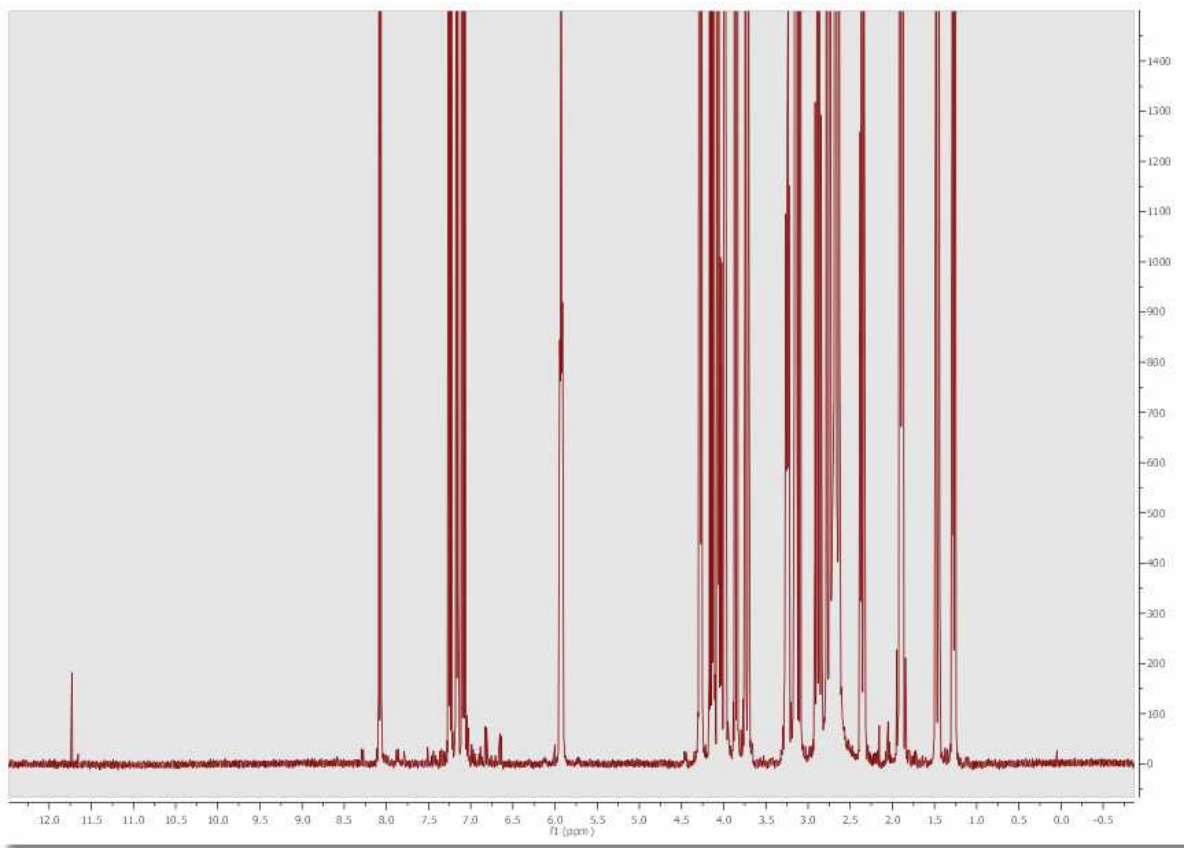

After subtracting the estimated baseline model, this is the resulting spectrum:





Let's see the functionality of each button of the "Multipoint Baseline Correction" dialog box:

'Pick Baseline points' : allows the user to pick the points. To remove any selected point (highlighted in green), just double click on it.

'Pick Borders' : allows the user to pick the first and the latest points.

'Clear all baseline' : click on this button to delete all the selected points.

'Show/Hide Settings Controls' : click on this button to select the baseline correction algorithm and the corresponding parameters.

'Toggles Preview Showing' : to see a preview of the baseline correction.

'Apply Baseline Correction' : to apply the correction.

'Free Selection' Free Selection : to pick a point anywhere.

'Average Window': The multipoint baseline algorithm builds a baseline model using the points selected; but if you select this option; instead of use the specific points selected in the spectrum when clicked, it uses an average value calculated from the point and the surrounded points given by the "average window" value. For example, and average window of 0 will use exactly the clicked/selected

point, and a average window of 2 will use the average of the clicked/selected point and 2 point from the left and 2 points from the right, ie, in total it will use $2*n+1$ points where n is the average window

'Algorithm': from this drop down menu, we can select the algorithm for the baseline correction:

Segments: it simply connects the points with flat lines. This baseline will not be smooth, it just abruptly links the points with segments.

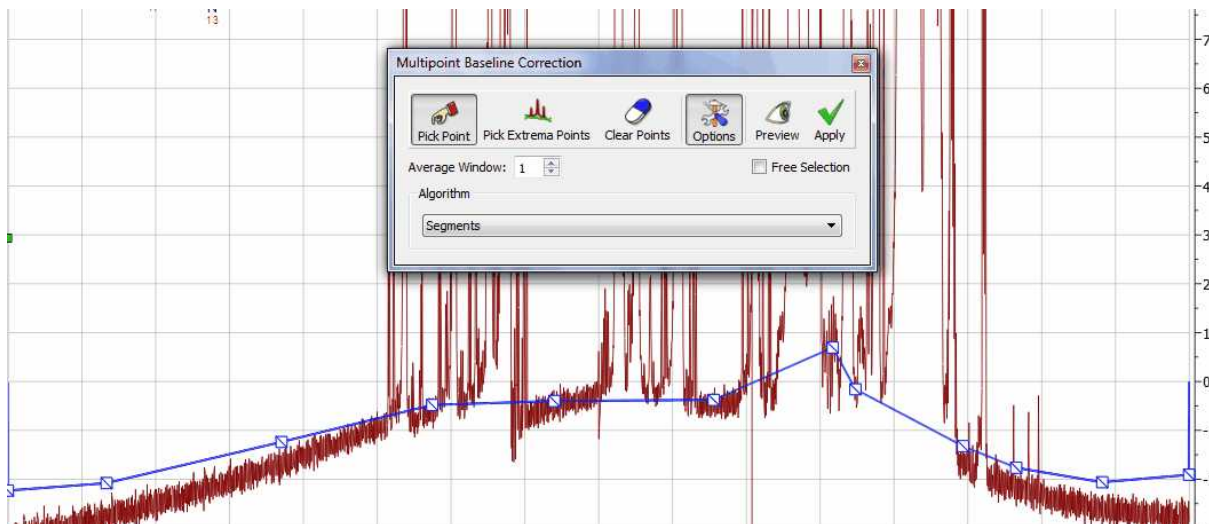

Cubic Splines: it uses smooth curves to link the points

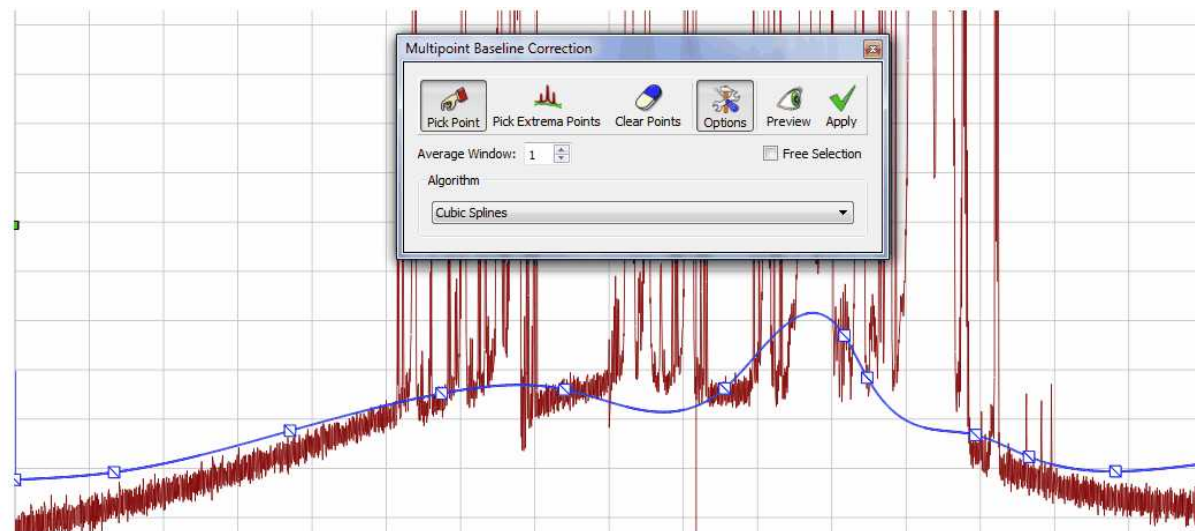

With segments and splines the baseline go through all the points defined by the user. This will not happen with the remaining algorithms:

Polynomial: the baseline will be adjusted to a polynomial function

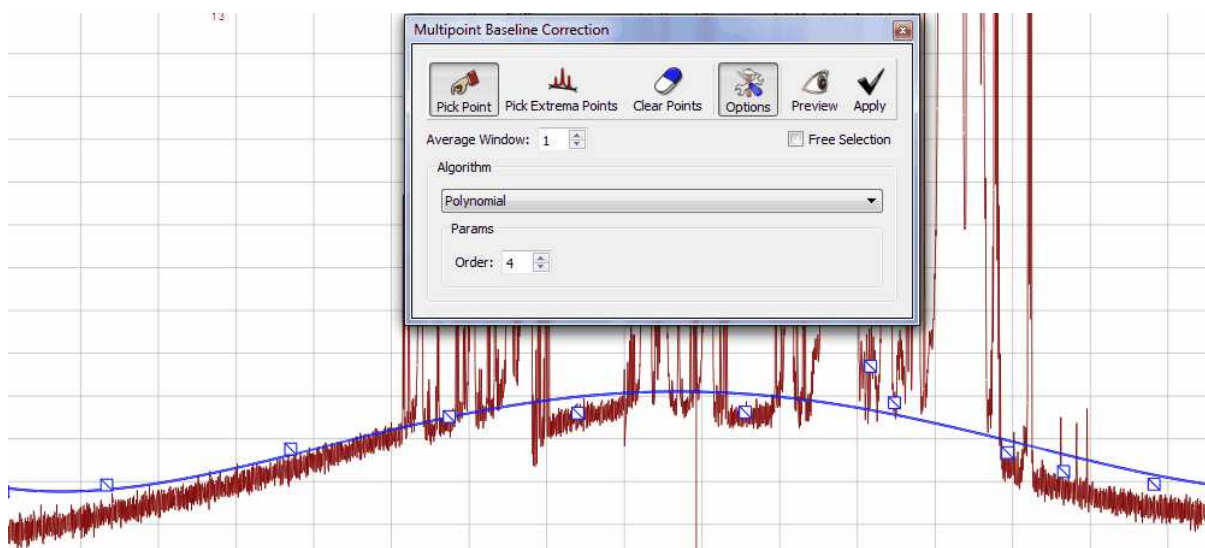

Withtaker: it will use the Withtaker Smoother algorithm to fit the baseline.

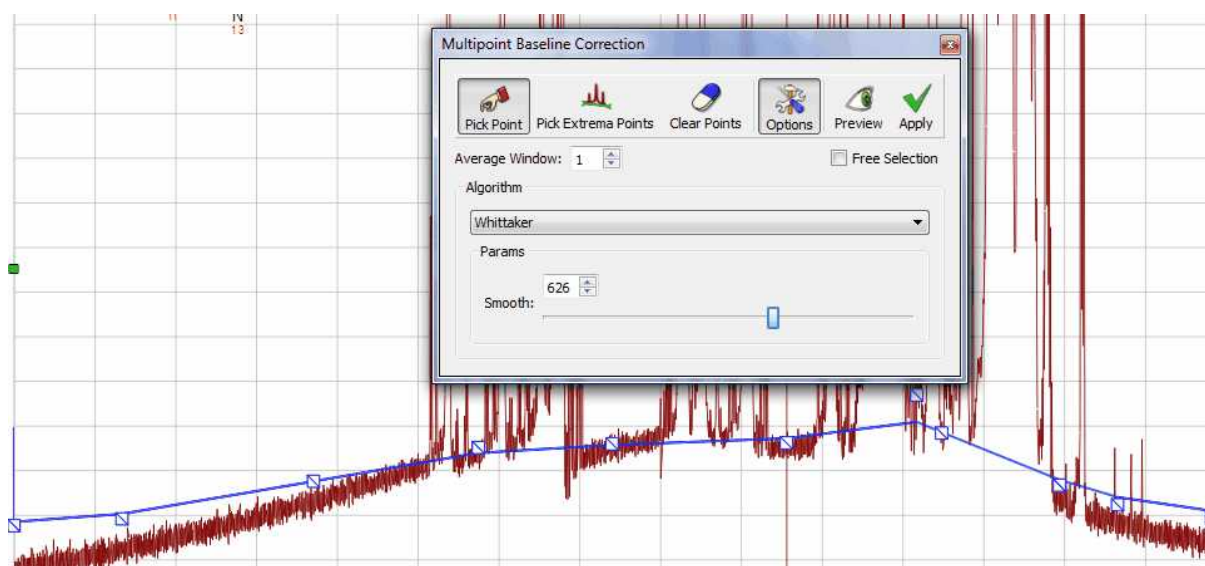

NOTE: After having applied a baseline correction in a 2D dataset, the manual phasing could be greyed out. To undo the baseline correction, follow the menu "Processing/Processing Template" and turn off the Baseline Correction for either dimension, click on OK and you will be able to correct the phase manually.

8.7 Symmetrization

Symmetrize (Not available in Mnova Lite):

This function, used in homonuclear correlation spectroscopy, replaces all signals which are symmetrically positioned about the diagonal by the smaller of the two signals. In this way unsymmetrically positioned noise and artifacts are removed. This technique should be used with caution since any symmetrical noise or artifacts will be preserved and may be mistaken for genuine

signals. The data can be cleaned up considerably by using this tool in square data sets (homonuclear experiments). There are two modes available:

Cosy-like mode

The most common type of symmetrization is performed on COSY type data where cross-peaks are symmetric on either side of a diagonal. This type of symmetrization is performed by following the menu 'Processing/Symmetrize/Cosy-like'. The command replaces the larger of two symmetrical points with a point that has the same magnitude as the smaller one. The user must know that this kind of symmetrization must not be used on phase sensitive data (because of the potential introduction of distortions to the cross peaks).

J-Resolved mode

For J-Resolved type data where the spectrum is symmetric on both sides of a horizontal line running through the middle of the matrix. The data point with the larger magnitude is replaced by one which has a magnitude equal to that of the smaller data point. This command is available by following the menu 'Processing/Symmetrize/J-Resolved'.

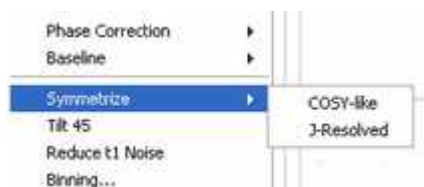

8.8 Tilt 45

Tilt 45 and Homonuclear J-resolved 2D-NMR spectroscopy (Not available in Mnova Lite):

Homonuclear J-resolved two-dimensional NMR spectroscopy is used to generate one frequency dimension representing chemical shifts and another with coupling constant information. This technique is most frequently used with homonuclear J-resolved spectra where the effect of couplings in the f2 dimension is not required.

The sequence:

$$d1 \dots 90^\circ \dots \frac{t_1}{2} \dots 180^\circ \dots \frac{t_1}{2} \dots t_2$$

(where $d1$ is for relaxation and $t_1/2$ and t_2 are the two time dimensions for the two-dimensional experiment) uses the 180° pulse to refocus chemical shifts during t_1 .

In a J-resolved spectrum, the ^1H frequencies are found on the horizontal axis (f2) with the normal 1D spectrum displayed at the top while the vertical axis (f1) contains only proton-proton coupled multiplets, each centered about a zero frequency point. Then, the 2D J-resolved spectrum may be 'tilted 45° ' (a projection at an angle of 45°) along a horizontal line through the center of the matrix, so that all the lines of each multiplet line up in the f1 dimension. Each row of the 2D matrix is shifted by an amount proportional to its distance from the middle of the spectrum. If all the individual spectra are now added together, the result is a ^1H decoupled NMR spectrum which is normally shown above the 2D spectrum.

Finally, the user could clean up the spectrum by symmetrizing it about the $f1 = 0$ Hz row. As it is explained in the previous chapter, this consists of comparing the intensities in the spectra equally spaced above and below the $f1 = 0$ Hz row and taking the smallest value.

This command is available by following the menu 'Processing/Tilt 45'.

8.9 Reducing t₁ Noise

Reduce t₁ noise (Not available in Mnova Lite):

t₁ noise is a particularly troublesome type of artifact which appears as streams of signals or ridges. The ridges (which are associated with strong signals in a contour plot), run parallel to the f₁ axis and are found at their chemical shifts along the f₂ axis. They can seriously interfere with the observation of real cross peaks from the signals.

The t₁ command allows the user to clean up the spectrum along the f₁ dimension by a factor proportional to the r.m.s. noise of that trace. It takes advantage of the fact that t₁ noise is normally associated with the intense peaks which can be reduced without a significant loss of information.

The algorithm for t₁-noise reduction has been designed to work with HSQC-like spectra.

This command is available by following the menu 'Processing/Reduce t₁ noise'.

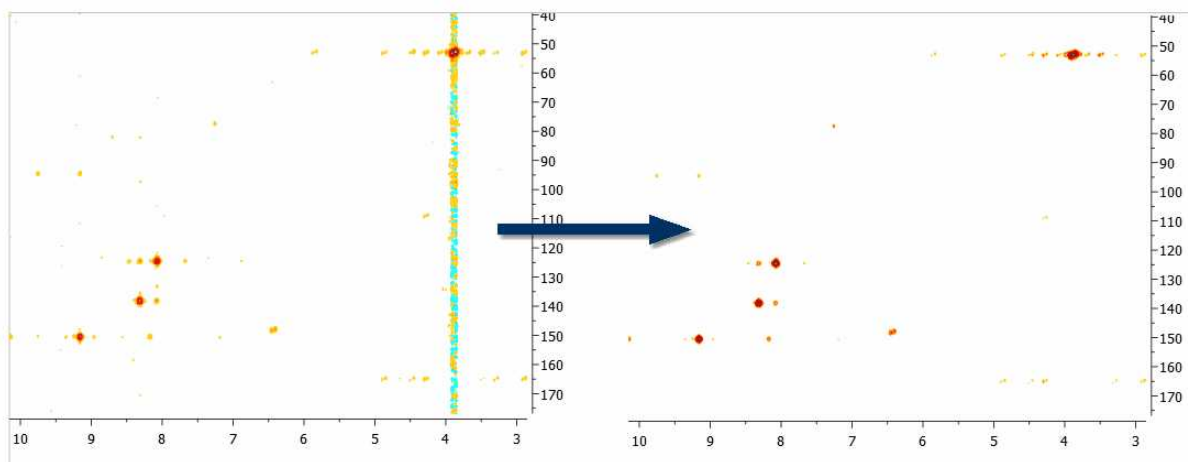

8.10 Covariance NMR

(Not available in Mnova Lite)

Resolution and sensitivity are two key factors in NMR spectroscopy. In the case of 2D NMR, the resolution of direct dimension (f₂) depends, among other things, on the number of acquired complex points whilst the resolution of the indirect dimension (f₁) is directly proportional to the number of increments (or number of acquired FIDs). In general, it could be said that the resolution along the direct dimension comes *for free* in a sense that increasing the number of data points does not augment the acquisition time of the experiment significantly. However, increasing the number of t₁ data points (increments) has a direct impact in the length of the experiment as can be seen from the Total acquisition time for a 2D NMR spectrum:

$$T = n * N1 * Tav$$

Where **n** is the number of scans per t₁ increment, **N1** is the number of T₁ increments and **Tav** is the average length of one scan. This usually means the resolution of the indirect dimension f₁ is kept lower than that of f₂.

You can easily apply the Covariance NMR tool just by following the menu 'Processing/Covariance NMR'. This will display the 'Covariance NMR' dialog box which will allow you to select the 'Regularization Factor', the 'Filter' and an 'Indirect Covariance NMR'

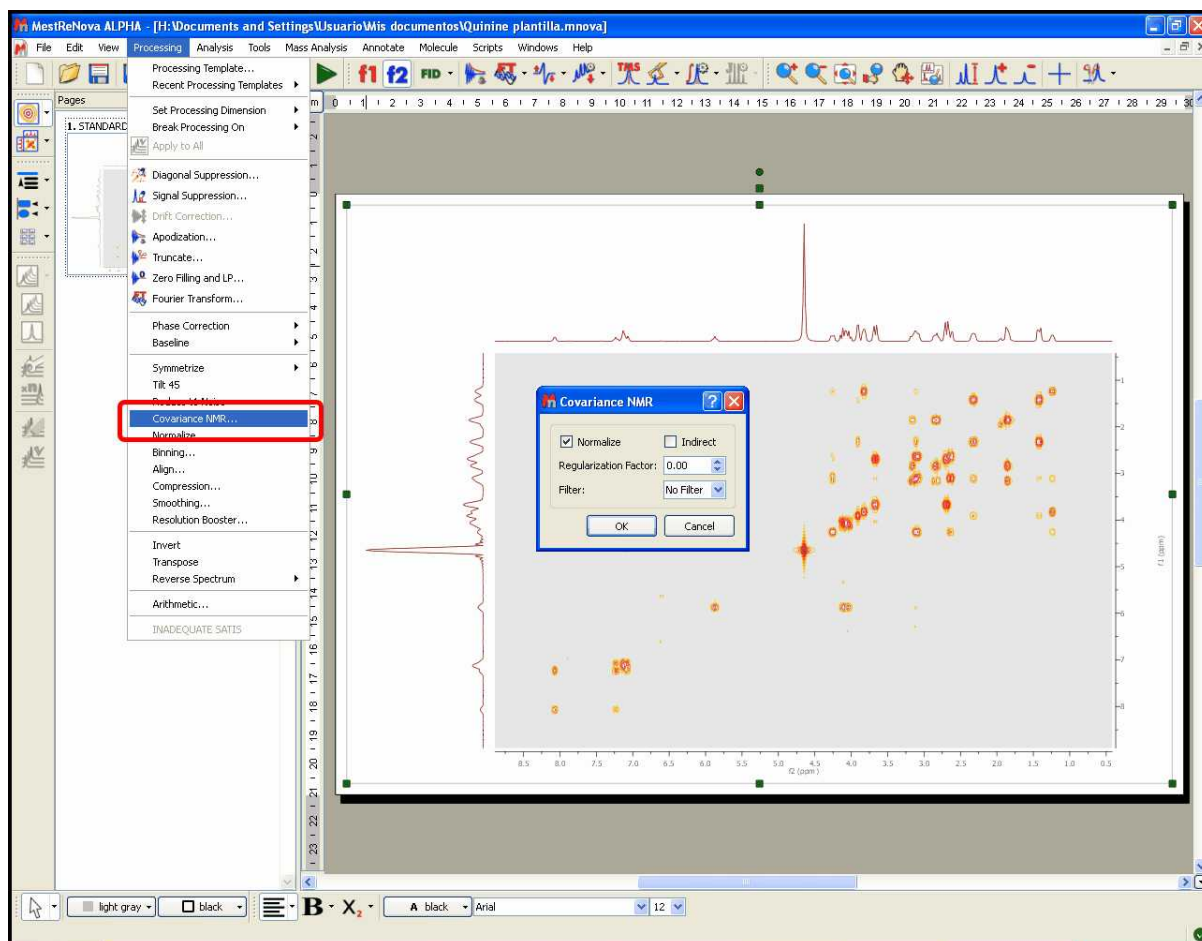

For example, let's consider the COSY spectrum (magnitude mode) of Strychnine which has been acquired with 1024 data points in the direct dimension and with 128 t1 increments. It's clearly appreciated that the resolution along F2 is much higher than the one along F1.

You can easily see that doublets corresponding to protons H20a and H23 are resolved in F2 but not in F1.

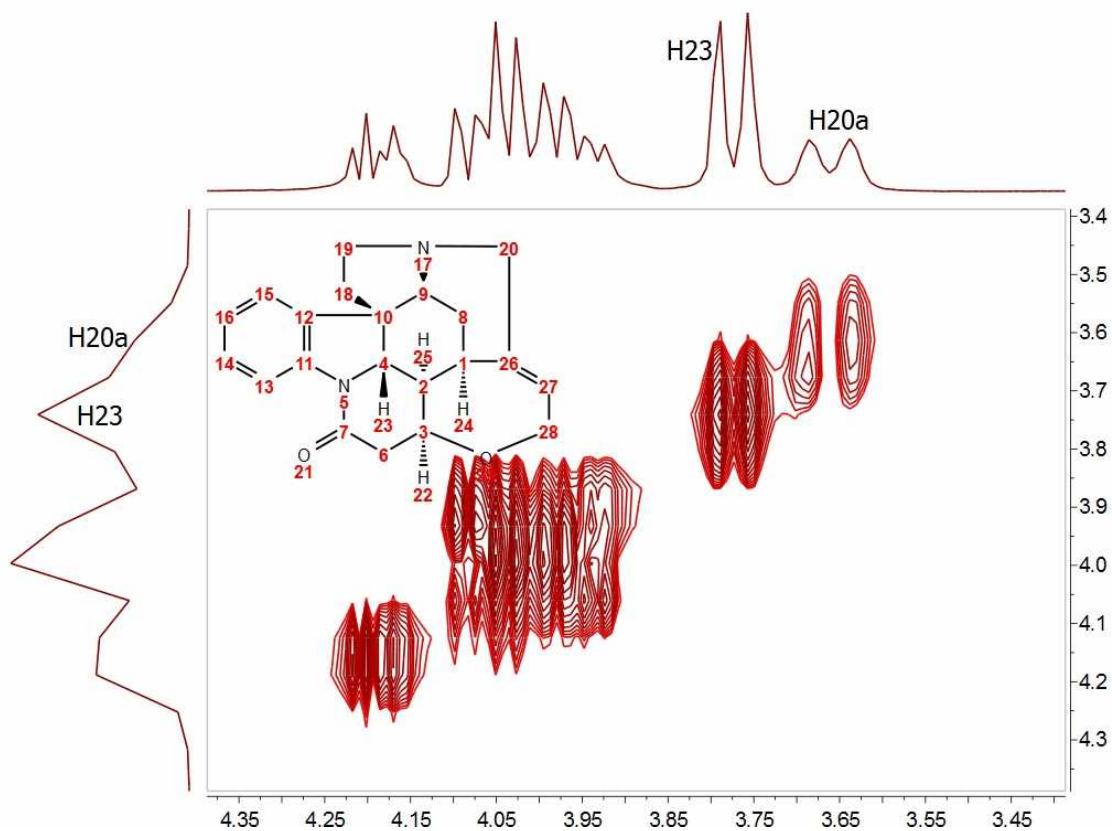

How could this be improved? We could try to extrapolate the FID (somehow) along the columns (F1) to a higher number of points (e.g. 1024). A well known and very simple technique is simply to add zeros, a process called [zero-filling](#) which basically is equivalent to a kind of interpolation in the frequency domain. For example, in this particular case we could try to extrapolate the FID along f1) from 128 to 1024 points in order to match the number of points along f2. The figure below shows the results:

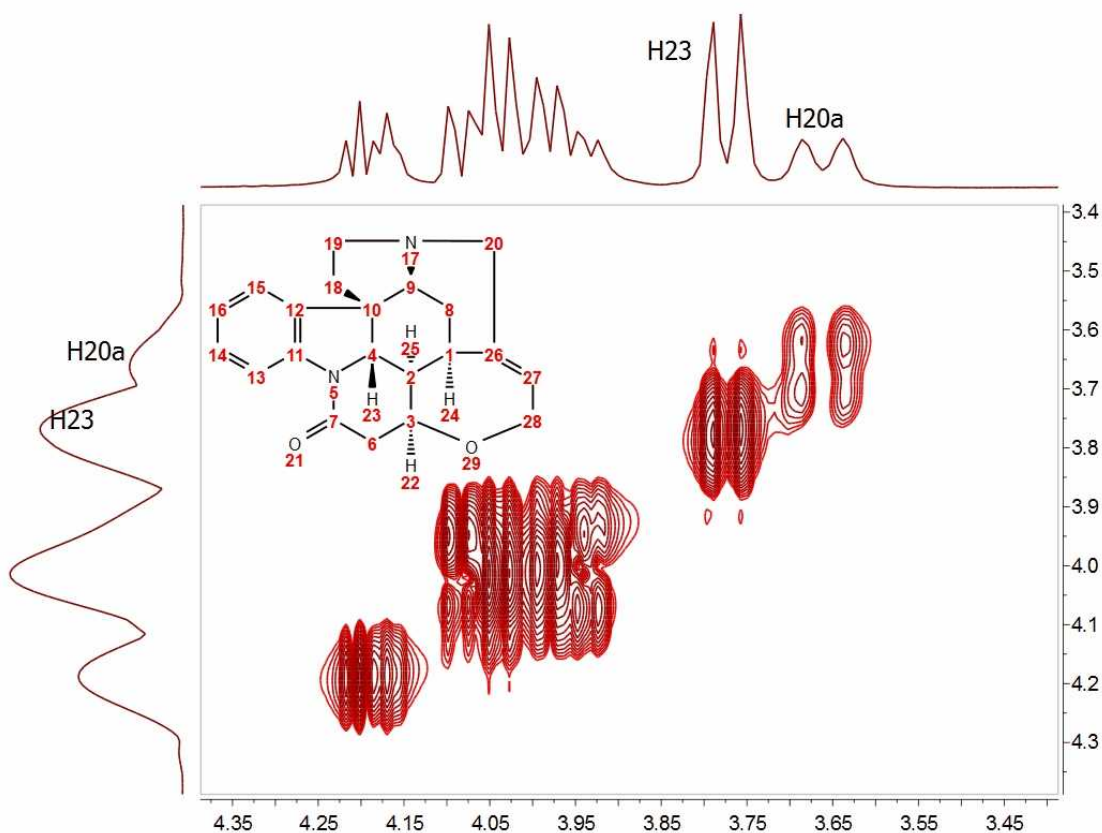

It can be observed now that the resolution along f1 is slightly higher than in the previous case but we cannot still appreciate the inner structure of the multiplets (e.g. H20a and H23). Zero Filling is certainly a good technique to improve resolution but of course, it cannot invent new information from where it does not exist. In this case we have zero filled from 128 to 1024 data points (e.g. 4 fold). In theory, zero filling by at least a factor of two is highly recommended because it enforces causality but beyond that, the gain in resolution is purely cosmetic. We might get more data point per hertz, but no new information is achieved as it's shown in the figure above.

Is there a better way to extrapolate the FID? Yes, and the answer is very evident: [Linear Prediction](#). In few words, Forward Linear Prediction uses the information contained in the acquired FID to predict new data points so that we are artificially extending the FID in a more natural way than with Zero Filling. Of course, we cannot create new information with this process but the resulting spectrum will look better. This is illustrated in the next figure:

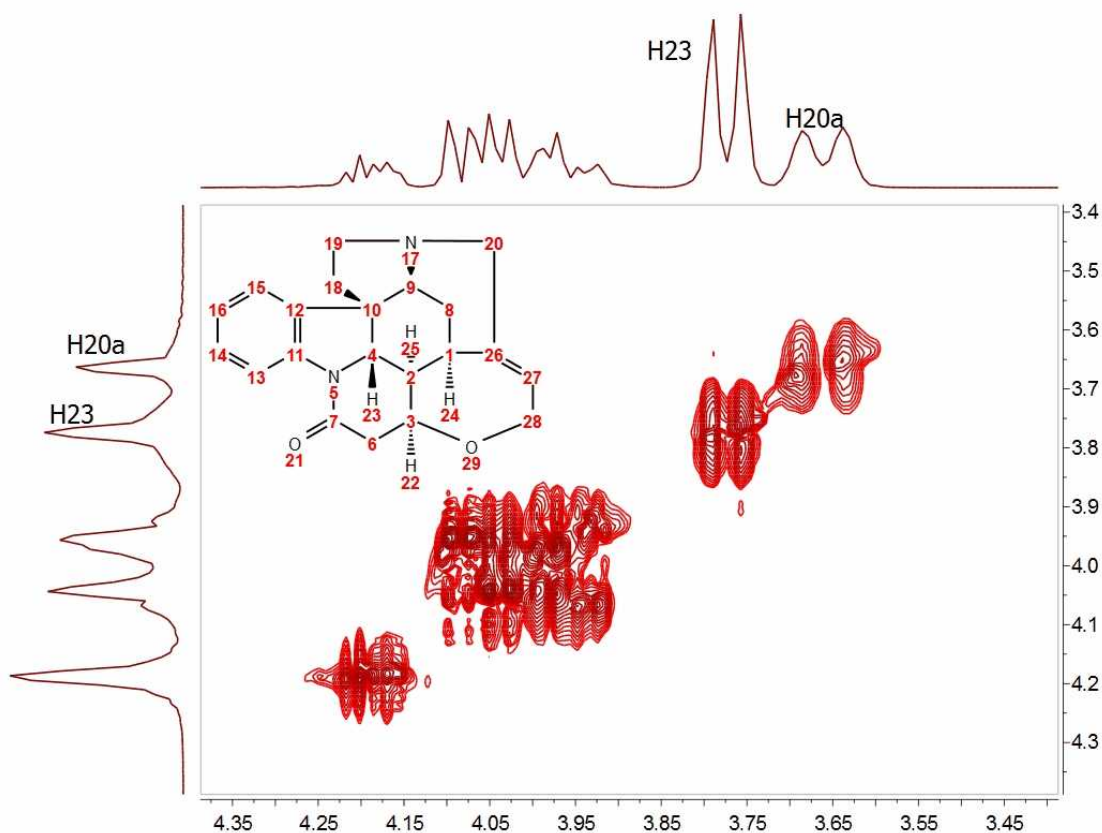

In this case, we have extended the t1-FID from 128 to 512 data points and then zero-filled up to 1024. Now we can see that the f1-lines are narrower but the couplings cannot be resolved yet.

In recent years there has been a great interest in the development of new methods for the time-efficient and processing of 2D (nD in general) NMR data. One of the more exciting methods is the so-called Covariance NMR (<http://spin.magnet.fsu.edu/software/covNMR/covNMR.html>), a technique developed by Brüschweiler et al. In fact, there are several types of Covariance NMR: Direct, Indirect Covariance NMR (there is a third method, Unsymmetrical Indirect Covariance which can be considered as a subtype of Indirect Covariance NMR). In this manual we will cover only the first type, Direct Covariance NMR leaving the other 2 types for future tutorials.

Before going any further with Covariance NMR, let's see the results of applying this technique to the same spectrum. This is what we get:

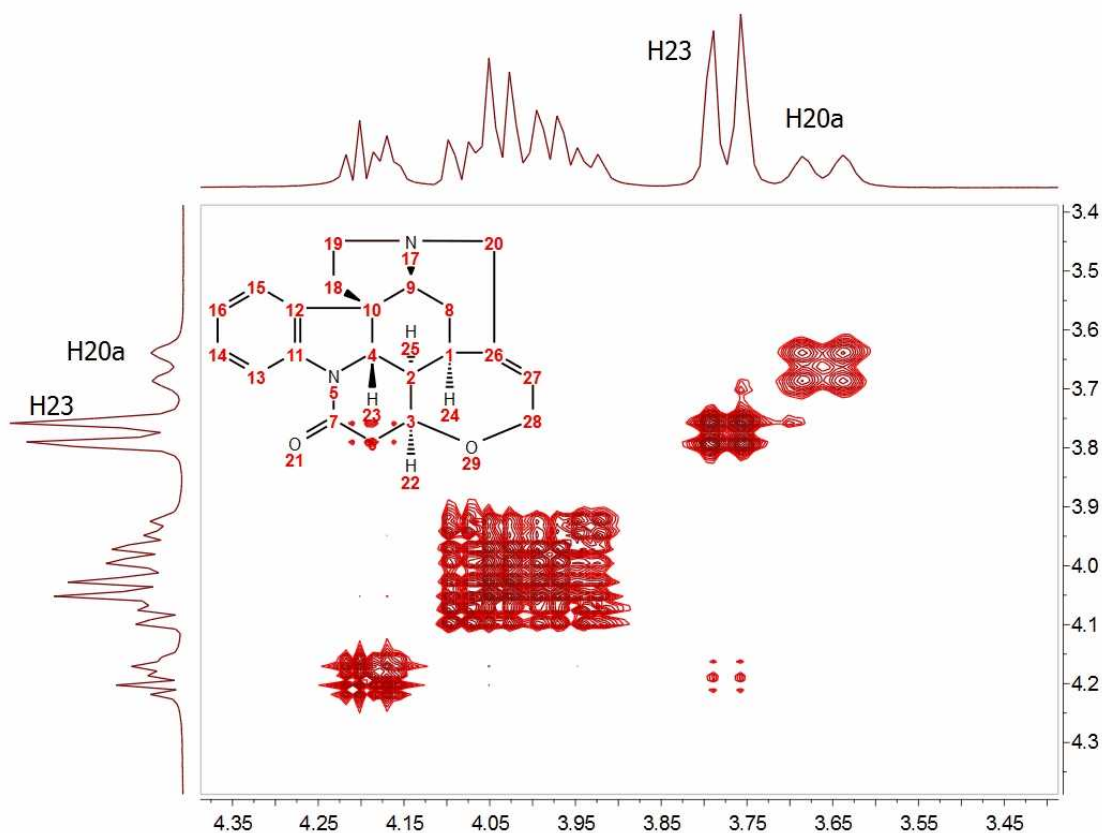

At first glance, this result looks like a kind of magic: Now the splitting of H20a and H23 are clearly resolved in both dimensions. Actually, the resolution along F1 is virtually analogous to that of the F2 dimension.

How did we arrive to such a good result? From an intuitive stand point, what we have attained here was a transfer of the resolution of F2 to the F1 dimension. In other words, we have applied a mathematical process which takes advantage of the higher spectral resolution in the F2 dimension to transfer it to the F1 one.

Mathematically, direct Covariance NMR is extremely straightforward as defined by the following equation:

$$\mathbf{C} = (\mathbf{F}^T \mathbf{F}) \quad (1)$$

Where C is the symmetric covariance matrix, F is the real part of the regular 2D FT spectrum and \mathbf{F}^T its transpose (NOTE: direct covariance NMR can also be applied in the mixed frequency-time domain, that's, when the spectrum has been transformed along F2. In this case, a second FT will not be required – neither apodization or phase correction along the indirect dimension).

In order to approximate the intensities of the covariance spectrum to those of the idealized 2D FT spectrum, the square root of C should be taken. Root squaring may also suppress false correlations that many be present in $\mathbf{F}^T \mathbf{F}$ due to resonance overlaps. Taking the square root of C matrix is in practice done using standard linear algebra methods (in short, diagonalizing the matrix and then

reconstruct $C^{1/2}$ using eigenvectors and square root of eigenvalues).

So direct Covariance NMR is able to produce a 2D spectrum in which the resolution in both dimensions is determined by that resolution of the spectrum in the direct dimension.

Let's see a stacked plot representation with the 1D projections obtained from the different processing methods described here (Zero-Filling, Linear Prediction and Direct Covariance NMR). You can see in the picture below the power of the Covariance NMR method.

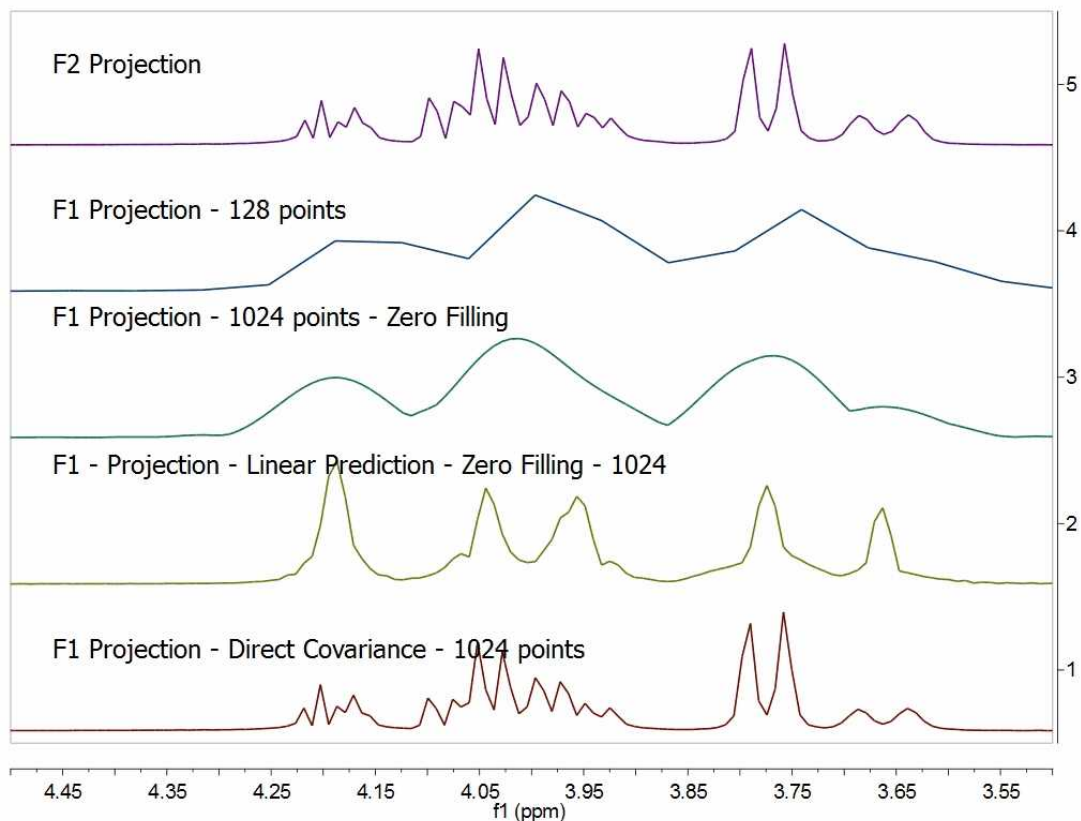

Covariance NMR spectroscopy provides maximal resolution along the indirect dimension, but when the number of acquired data points is too small, the covariances exhibit poor statistics that manifest themselves as spurious cross-peaks. For example, in this case we can see some unexpected cross peaks (e.g correlation H27 and H23 which in principle should not appear in a GCOSY spectrum, but rather in a TOCSY spectrum). Some other artefacts might also arise when protons of different spin systems are coupled to resonances with overlapping proton multiplets.

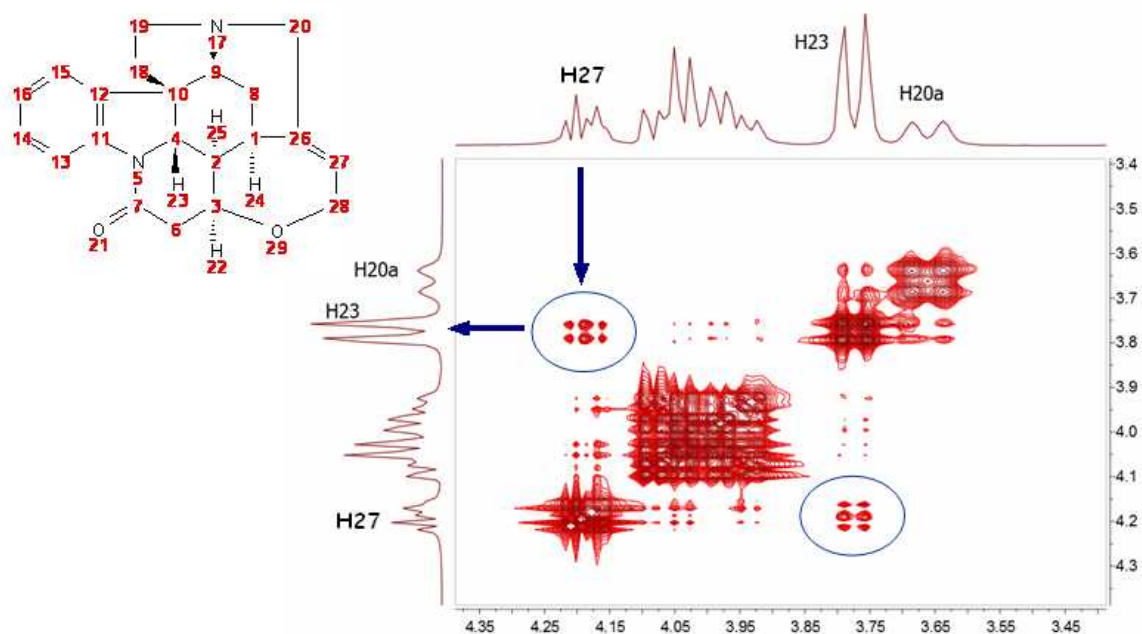

Mnova includes a novel filter which addresses this situation. This filter combines the standard 2D FFT spectrum with the CoNMR version in such a way that the resulting spectrum, while keeping the high spectral resolution along F1, it's free of artefacts:

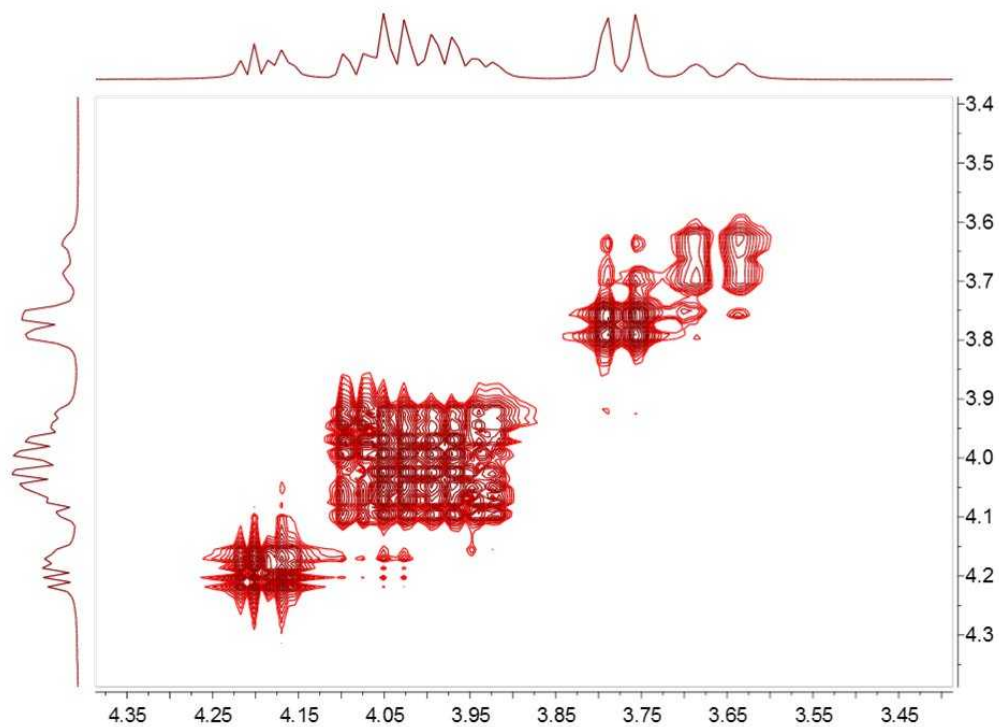

INDIRECT COVARIANCE NMR

Interestingly, if we have a heteronuclear spectrum, it's possible to transfer the correlation information from the indirect dimension to the direct one by simply changing the order in which the multiplication is carried out:

$$C_{\text{indirect}} = (F \cdot F^T)^{1/2}$$

For example, the spectrum below shows the HSQC-TOCSY spectrum of sucrose (left) and its resulting indirect covariance counterpart (right) which contains essentially the same spin-connectivity information as a ^{13}C - ^{13}C TOCSY with direct ^{13}C detection:

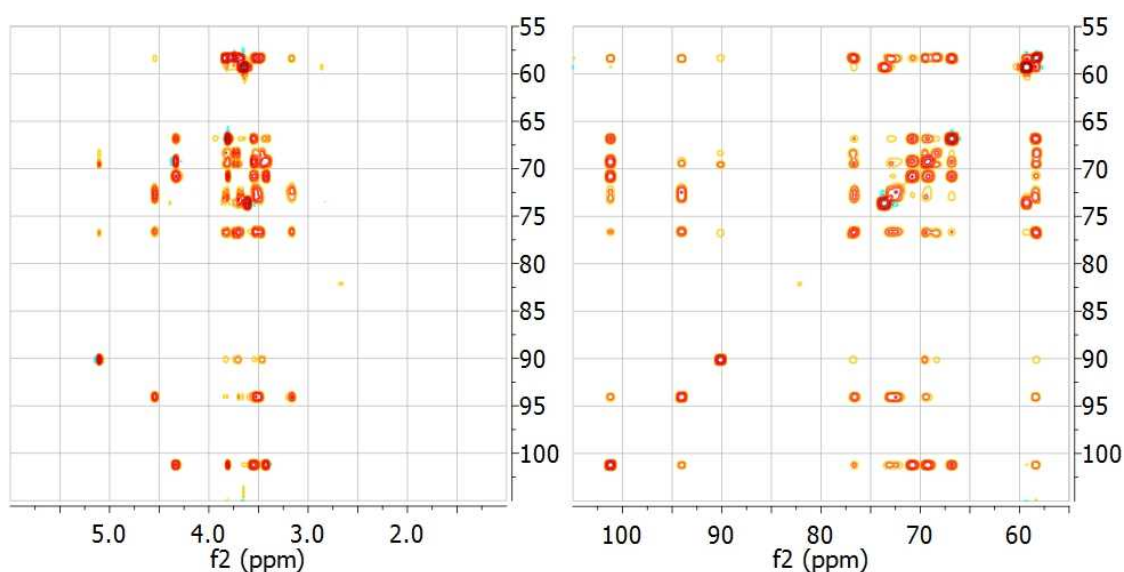

The advantage is obvious: Indirect Covariance NMR yields a ^{13}C - ^{13}C TOCSY correlation without having to detect the ^{13}C nucleus. In other words, it brings in a sensitivity increase of 8 over a ^{13}C detected experiment. Of course, in indirect covariance NMR spectroscopy, the spectral resolution along both frequency axes is determined by the sampling along the evolution t_1 time.

UNSYMMETRICAL COVARIANCE NMR

It is also possible to carry out **unsymmetrical Covariance NMR** with Mnova. However, as opposed to direct/indirect covariance NMR where one needs to deal with just one single spectrum, unsymmetrical NMR processing is probably not as intuitive as it's necessary to use 2 independent spectra and we have decided to implement it using a very open and flexible approach, that is, by using the spectral arithmetic module.

There two ways to apply an 'Unsymmetrical CoNMR' with Mnova:

1. Using the Arithmetic feature
2. **Using the Generalized Indirect Covariance NMR**

As you can see above, Covariance NMR is all about matrices operations. When you use direct/indirect CoNMR you simply multiply the spectrum matrix by its transpose where the order of the multiplication

depends upon the CoNMR technique (direct vs indirect). The same concept applies to unsymmetrical CoNMR where you just need to multiply one spectrum by the transpose of another one.

Let's see an example to apply an unsymmetrical CoNMR by using the '**Arithmetic**' feature of Mnova, assuming that matrix A corresponds to an HSQC spectrum and matrix B corresponds to a COSY (or TOCSY) spectrum, unsymmetrical CoNMR can be achieved by the following matrix operation:

$$C = A * \text{TRANS}(B)$$

Where TRANS denotes matrix transposition.

It's important to bear in mind that with any algebraic matrix operation, it's necessary that matrices A & B are compatible according to their row/column dimensions.

To carry out unsymmetrical CoNMR, just open the 2 individual spectra in Mnova, process then as usual (making sure that the sizes are compatible) and finally go to Processing/Arithmetic to enter the desire equation (e.g. $A * \text{TRANS}(B)$)

Let's see step by step, how to generate a HSQC-COSY from separate HSQC and COSY spectra with Mnova

1. Import the HSQC and COSY spectra into Mnova
2. Select both spectra in the page navigator and follow the menu 'Processing/Arithmetic'

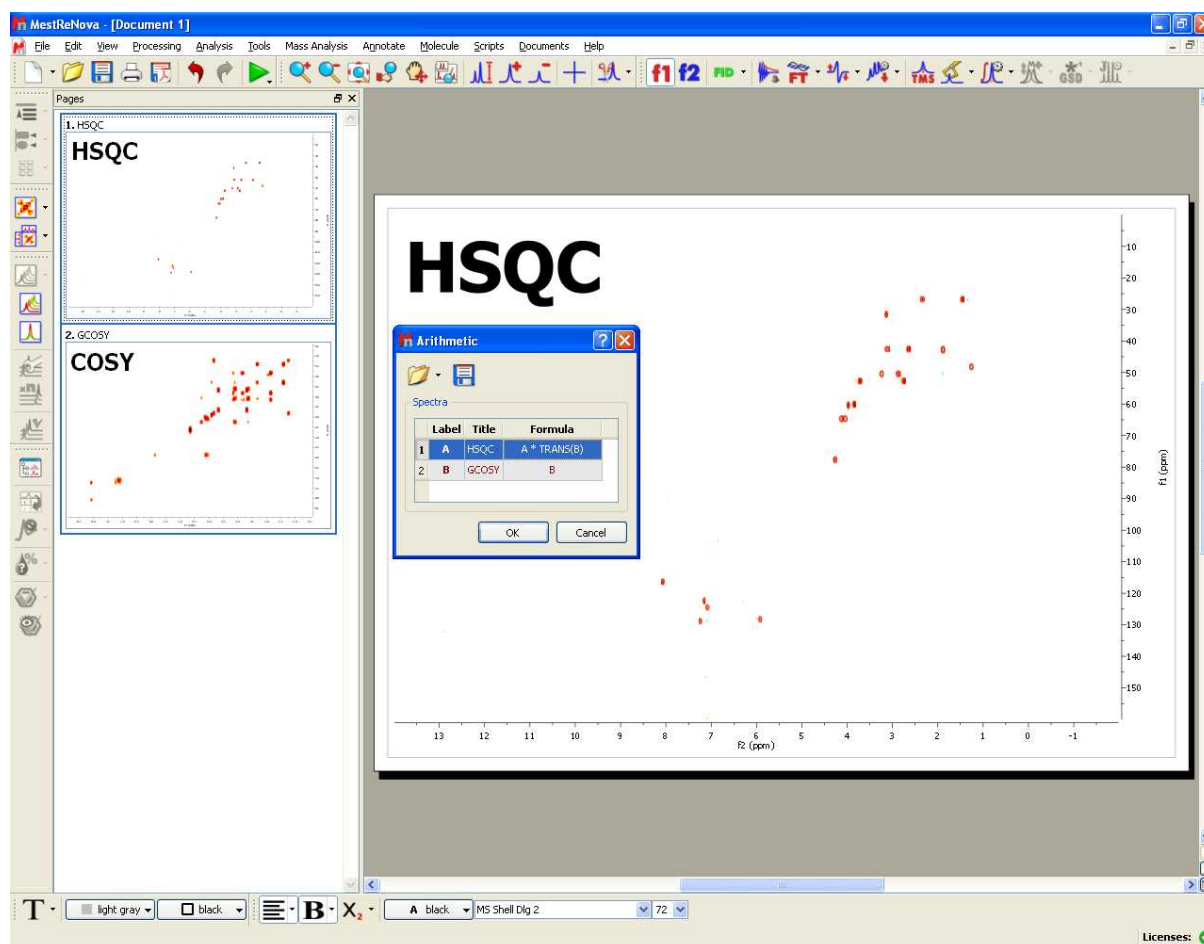

Finally enter the equation as depicted above "A*TRANS(B)". In this case A corresponds with the HSQC spectrum whereas B is the COSY experiment. TRANS means the transpose operation.

Once the operation has been applied, click on the fit to height button . You should get something like this:

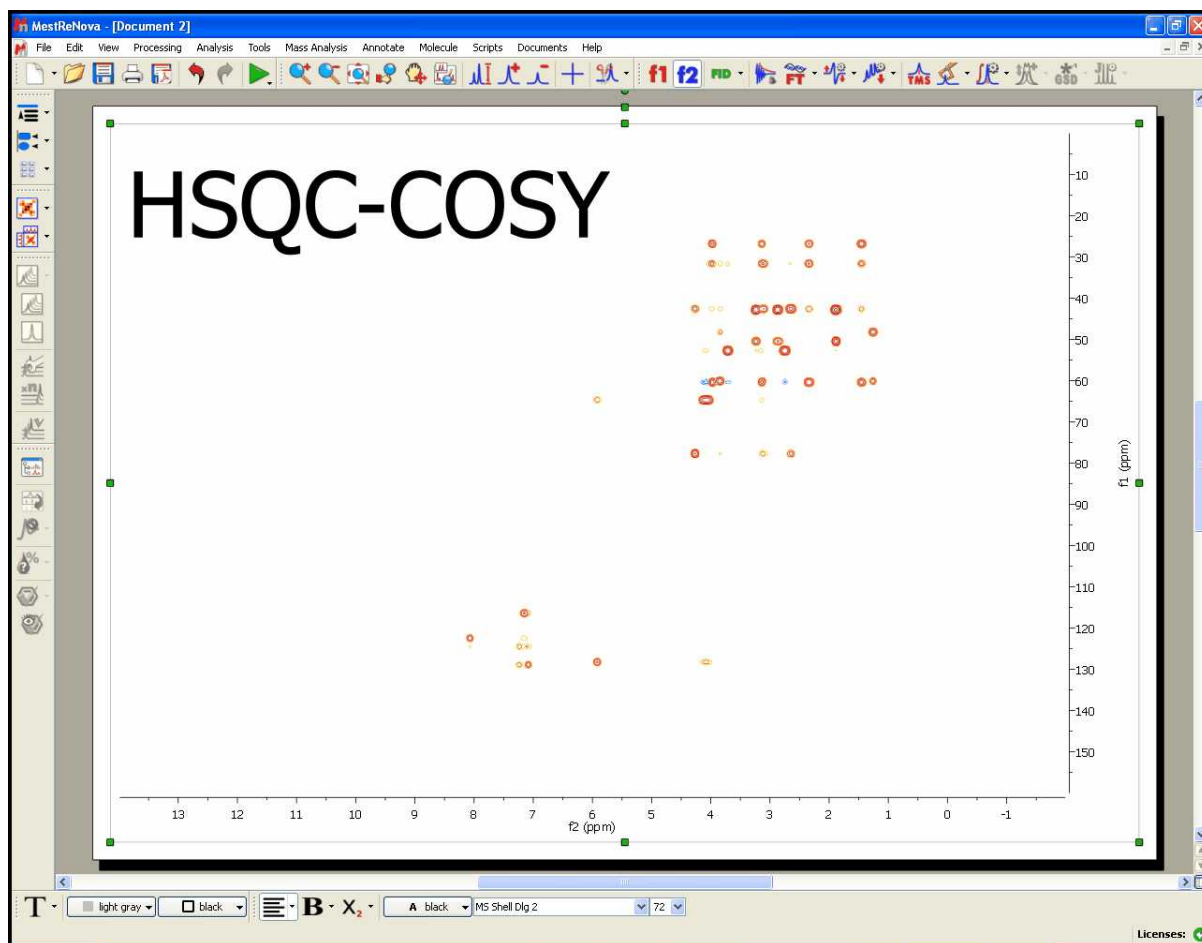

Generalized Indirect Covariance NMR (GIC)

Multidimensional nuclear magnetic resonance (NMR) experiments measure spin-spin correlations, which provide important information about bond connectivities and molecular structure. However, direct observation of certain kinds of correlations can be every time-consuming due to limitations in sensitivity and resolution.

Covariance NMR derives correlations between spins via the calculation of a symmetric covariance matrix, from which a matrix-square root produces a spectrum with enhanced resolution. The covariance concept has also been adopted to the reconstruction of non symmetric spectra from pairs of 2D spectra that have a frequency dimension in common. Since the unsymmetric covariance NMR procedure lacks the matrix square root step, it does not suppress relay effects and thereby may generate false positive signals due to chemical shift degeneracy. This generalized covariance formalism permits the construction of unsymmetric covariance NMR spectra subjected to arbitrary matrix functions, such as the square root, with improved spectral properties.

This method is basically the same as the above one (Arithmetic) but using a more rigorous mathematic formalism which allows to minimize the number of false positive peaks, because now the user will be able to do the square of the two matrix product (or any other values of the lambda parameter; ie: 0.25)

To use this method, just load your datasets and follow the menu 'Processing/Covariance NMR/Generalized Indirect Covariance'. Finally select the spectra that you want to use and enter the value for the lambda parameter.

Please bear in mind that both spectra must have the same number of points in F2 to apply GIC

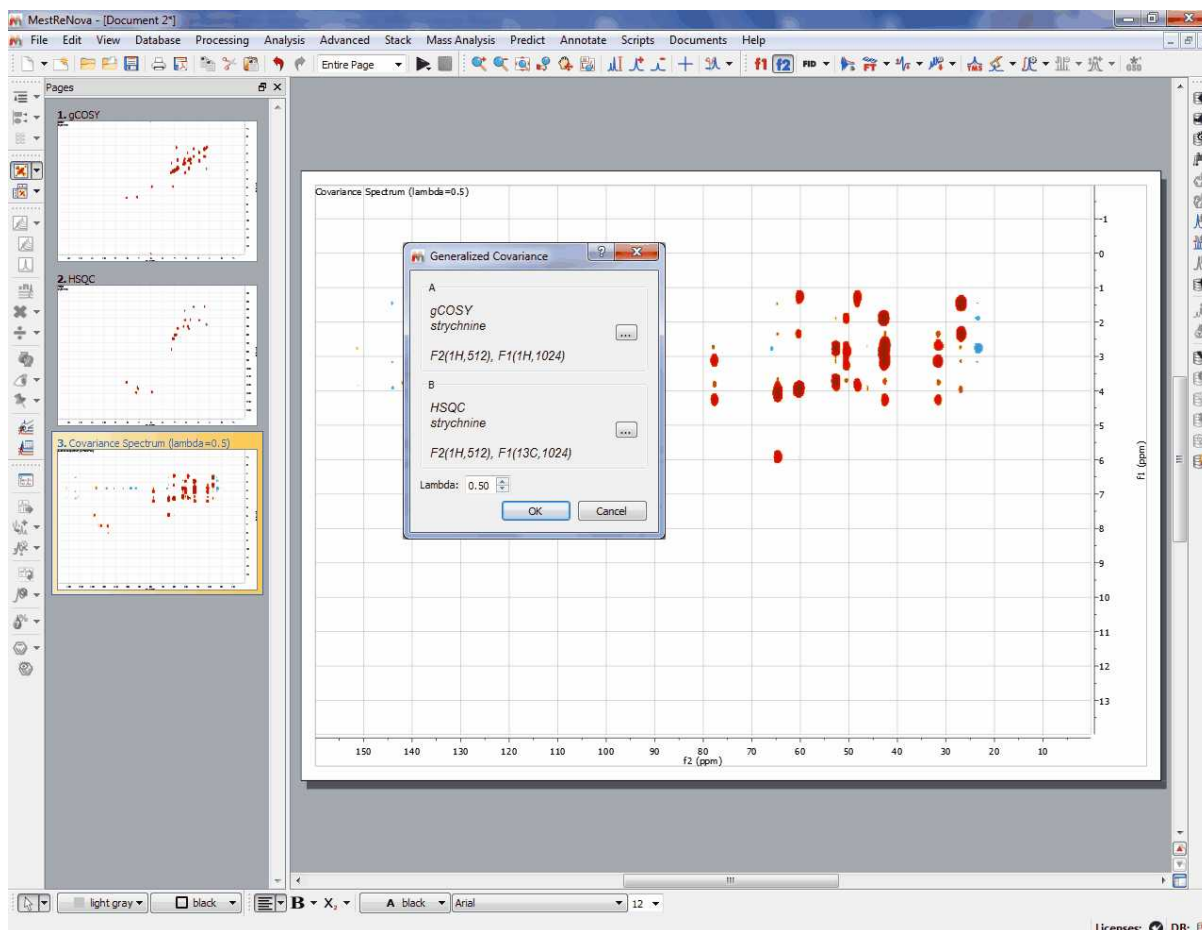

For further information about this feature, please read our blog:

<http://nmr-analysis.blogspot.com/2008/10/introduction-to-covariance-nmr.html>

<http://nmr-analysis.blogspot.com/2008/11/indirect-covariance-nmr-fast-square.html>

<http://nmr-analysis.blogspot.com/2008/11/removal-of-artifacts-in-direct.html>

8.11 Normalization

Normalization:

The user is able to normalize the intensity of the spectrum by using this tool located in the 'Processing Menu'. The user can normalize the spectrum (or the spectra) by five different methods: Total Area,

Largest Peak, a desired Peak, a peak Range or the 'Manual Normalization' (the spectrum will be multiplied for the value that the user has typed in the edit box):

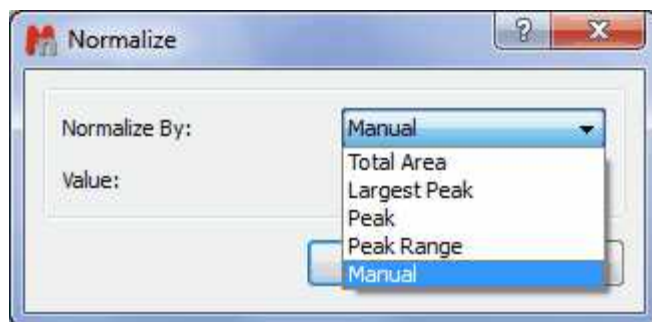

'Largest Peak' and 'Peak' will normalize the intensity of the peaks and 'Total Area', 'Peak Range' and 'Peak' will normalize the area of the involved peaks



Utilities:

This tool is extremely useful when the user wants to stack spectra with different relative intensities and also after applying a binning.

8.12 Binning

Binning:

Spectral binning is a widely-used technique where the spectrum is subdivided into several regions (bins), and the total area within each bin is used as an abstracted representation of the original spectrum. The area encapsulated by a bin would ideally capture all of the area associated with a given resonance across all spectra in the dataset, thereby mitigating the effect of minor peak shift and line width variations for a compound across samples.

This command is available by following the menu 'Processing/Binning'. Then, the 'Binning' dialog box will open and the user can choose the desired limits of the spectrum to apply the binning (or select Full Spectrum). The user can also select the width of each integral region. A typical 64k point NMR spectrum would be reduced using bin widths of 0.04 ppm, resulting in ~250 bin integral values.

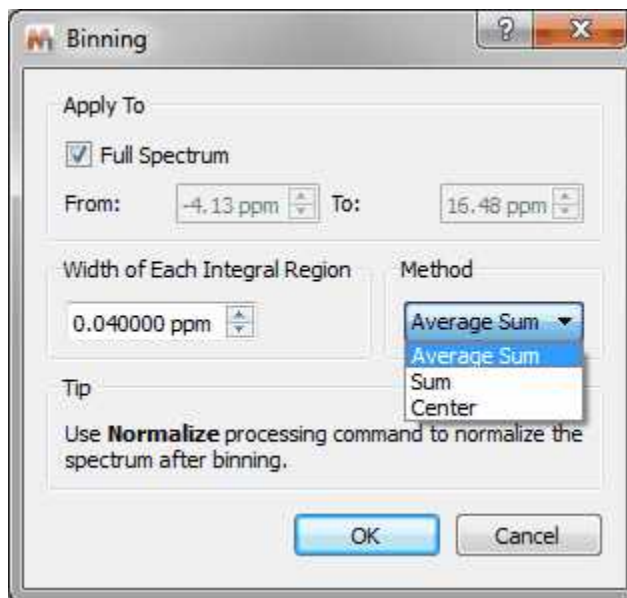

The 'Sum' method will sum all the points of the bucket, the 'Average Sum' will divide the sum by the number of points on the bin and the 'Center' method will only return the value found in the middle of the bin. For example if the bin has 5 points it will return the value for 3rd point.

Binning (also called bucketing) is a tool used in the multivariate analysis of NMR-based metabonomics data to address the NMR peak misalignment issue. In NMR metabonomics, small variations in the resonance position of the individual peaks caused by experimental and instrumental variations can adversely impact PCA results.

Fixed-width binning (usually at 0.04 ppm) is commonly used to alleviate the impact of the peak misalignment by averaging up the data points falling inside the bin width. However, since it drastically reduces the data resolution, it makes it more difficult to interpret the PCA results such as identifying the changed metabolites from the loadings plot.

The goal of binning a spectrum is to produce a new spectrum in which each new spectral data point corresponds to the integral of a bucket with a given width (e.g. 0.04 ppm). In other words, this is simply a data reduction operation analogous to bucketing integration. Once the spectrum has been binned, you can export it in ASCII format in order to use it for further PCA analysis.

It is often convenient to use the [Normalize](#) processing command to normalize the spectrum after applying a binning.

See also [here](#) an practical example of this feature

8.13 Compression

Compression (Not available in Mnova Lite):

A typical 2D experiment could be as large as 64Mb, whereas the final size of a processed 4D spectrum reaches easily the gigabyte range, resulting in a considerable burden on the data storage and backup systems and in low processing efficiency. Furthermore, these data must be transmitted and stored on computer networks. It is clear that advances in technology for transmission or storage are not sufficient to solve this problem. These considerations clearly raise the issue of efficient data compression.

Mnova incorporates a fast in-house developed wavelet-based compression algorithm, which is

generally applicable to 2D NMR data sets (obtaining high compression rates; up to 800:1). We have tested this compression methodology with some examples of 2D spectra focusing on keeping the NMR signal information intact either on cases of qualitative purposes of signal assignment or on quantitative analysis as commonly required for solution structure calculations derived from nuclear Overhauser effects.

This command is available by following the menu 'Processing/Compression'. Then an 'Open' dialog will be shown:

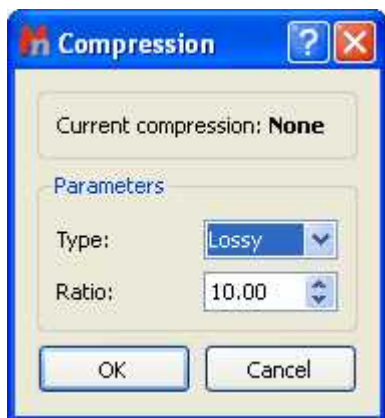

The user can select the Compression Ratio or select 'Type:Lossless'. Lossless data compression allows the exact original data to be reconstructed from the compressed data.

8.14 Smoothing

Smoothing (Not available in Mnova Lite):

The signal to noise ratio (S/N) of a spectrum can be enhanced by smoothing (or filtering) techniques. This technique is used to reduce the effect of noise on a spectrum and possibly reveal signals embedded in, or distorted by, noise. Noise contains rapid fluctuations which are generally faster than the rates of change of genuine signals. Smoothing applies a low-pass filter to the spectral data to remove these rapid fluctuations while having minimal effect on signals.

Mnova incorporates some of the more used signal smoothing algorithms.

This command is available by following the menu 'Processing/Smoothing'. Then, a dialog box will open:



The user can select the smoothing algorithm (Moving Average Filter, Whittaker Smoother, Savitzky-Golay or Wavelets) in the Method scroll bar. The user can also apply the smoothing to All Dimensions (by ticking the applicable box).

'Moving average algorithm' : The simpler software technique for smoothing signals consisting of

equidistant points is the moving average. An array of raw (noisy) data (y_1, y_2, \dots, y_N) can be converted to a new array of smoothed data. The "smoothed point" $(y_k)_s$ is the average of an odd number of consecutive $2n+1$ ($n = 1, 2, 3, \dots$) points of the raw data $y_{k-n}, y_{k-n+1}, \dots, y_{k-1}, y_k, y_{k+1}, \dots, y_{k+n-1}, y_{k+n}$, i.e.

$$(y_k)_s = \sum_{i=-n}^{i=n} \frac{y_{k+i}}{2n+1}$$

The odd number $2n+1$ is usually named filter width (or span in Mnova). The greater the filter width the more intense the smoothing effect.

The moving average algorithm is particularly damaging when the filter passes through peaks which are narrow compared to the filter width.

The user can select the desired filter width (Span) in the dialog box.

Whittaker Smoother: A smoothing algorithm is proposed by Whittaker in 1923. If y is a series of m data points and z is the smooth series which should approximate y , we minimize:

$$Q_2 = \sum_{i=1}^m (y_i - z_i)^2 + \lambda \sum_{i=2}^m (z_i - z_{i-1})^2$$

The first term measures the fit of z to y , the second term is a so-called penalty: it discourages changes in z . The influence of the penalty is tuned by the parameter λ ; the larger a λ is chosen, the smoother z will be, at the cost of a worse fit to the data.

The user can select the Smooth Factor in the dialog box or let Mnova detect the best one automatically.



'Savitzky-Golay algorithm' : A much better procedure than simply averaging points is to perform a least squares fit of a small set of consecutive data points to a polynomial and take the calculated central point of the fitted polynomial curve as the new smoothed data point.

Savitzky and Golay showed that a set of integers $(A_{-n}, A_{-(n-1)}, \dots, A_{n-1}, A_n)$ could be derived and used as weighting coefficients to carry out the smoothing operation. The use of these weighting coefficients, known as convolution integers, turns out to be exactly equivalent to fitting the data to a polynomial, as just described, and it is computationally more effective and much faster. Therefore, the

smoothed data point $(y_k)_s$ by the Savitzky-Golay algorithm is given by the following equation:

$$(y_k)_s = \frac{\sum_{i=-n}^n A_i y_{k+i}}{\sum_{i=-n}^n A_i}$$

Sets of convolution integers, instead of the smoothed signal, can be used to obtain directly, instead, its 1st, 2nd, ..., mth order derivative, therefore the Savitzky-Golay algorithm is very useful for calculation of the derivatives of noisy signals consisting of discrete and equidistant points.

The smoothing effect of the Savitzky-Golay algorithm is not as aggressive as in the case of the moving average and the loss and/or distortion to vital information is comparatively limited. However, it should be stressed that both algorithms are "lossy", i.e. part of the original information is lost or distorted. This type of smoothing has only cosmetic value.

The user can select the 'order' and the 'Width' as the dialog box below shows:



Wavelets: Wavelet thresholding is the basis of wavelet based noise reduction. For a function f with Gaussian noise

$$y_i = f(t_i) + \sigma \varepsilon_i \dots (i \in \mathbb{N})$$

this means that the function f is restored.

Hard thresholding is a simple "keep or kill" selection. All wavelet coefficients below a threshold λ are zeroed.

$$c_{j,k}^{hard} = \begin{cases} 0, & |d_{j,k}| \leq \lambda \\ c_{j,k} & |c_{j,k}| > \lambda \end{cases}$$

Soft thresholding shrinks the coefficients towards zero:

$$c_{j,k}^{soft} = \begin{cases} c_{j,k} - \lambda, & c_{j,k} > \lambda \\ 0, & |c_{j,k}| \leq \lambda \\ c_{j,k} + \lambda, & c_{j,k} < -\lambda \end{cases}$$

The most important step is now a proper choice of the threshold λ .

A *universal threshold* consists of:

$$\lambda = \frac{\sigma \sqrt{2 \log n}}{\sqrt{n}}$$

where n is the sample size and σ the scale of the noise on a standard deviation scale.

The overall procedure of noise suppression consists of a wavelet transform (WT), which yields the wavelet coefficients $c_{j,k}$, followed by thresholding of these coefficients and by an inverse wavelet transform (IWT), which restores the original spectrum.

The user can select the scale (σ) and the fraction threshold ($\lambda\%$) or also the soft or the Universal Threshold (by ticking the applicable box).



8.15 Resolution Booster

Resolution Booster (Not available in Mnova Lite):

Resolution is a key concept in high resolution NMR and considerable effort (e.g. shimming) is usually devoted to ensure optimum resolution. High spectral resolution is important for the measurement of NMR parameters, especially for signal intensities, chemical shifts, and coupling constants. However, in many areas of high-resolution NMR the observed resonance lines are broadened in some undesirable way that may complicate, if not preclude, the accurate analysis of e.g. scalar couplings. Moreover, it is

possible to directly measure accurate values of J only when the splitting is much larger than the linewidth. The classical solution to the line broadening problem, other than using higher magnetic fields and assuming proper shimming, is multiplication of the FID by a resolution-enhancement function. More sophisticated procedures involve nonlinear data-processing methods such as the much-discussed maximum entropy method. The Filter Diagonalization Method (FDM) and Reference Deconvolution are other well known processing procedures that can be used for resolution enhancement.

The most frequently used methods for resolution enhancement are those which involve appropriate mathematical treatment of the FID (weighting). For example, one popular, routinely used weighting function is the Lorentzian/Gaussian transformation. Other well-known weighting functions include the TRAF, convolution difference, and sine-bell functions. Most of these methods have in common that they alter the FID such that its beginning is deemphasized, relative to the latter parts. Although these methods can improve resolution significantly, caution must be taken because information can be destroyed or artefacts created by extreme enhancement, such as that which results in large negative lobes on both sides of a signal.

The **Resolution Booster** is a new frequency domain post processing method which yields a considerable resolution enhancement with a fast calculation, while avoiding the negative artefacts of the other resolution enhancement functions.

Real Example:

In order to illustrate the power of our Resolution Booster method, we will use as an example the spectrum of **dimethyl pyridine-2,5-dicarboxylate** acquired at 250 MHz:

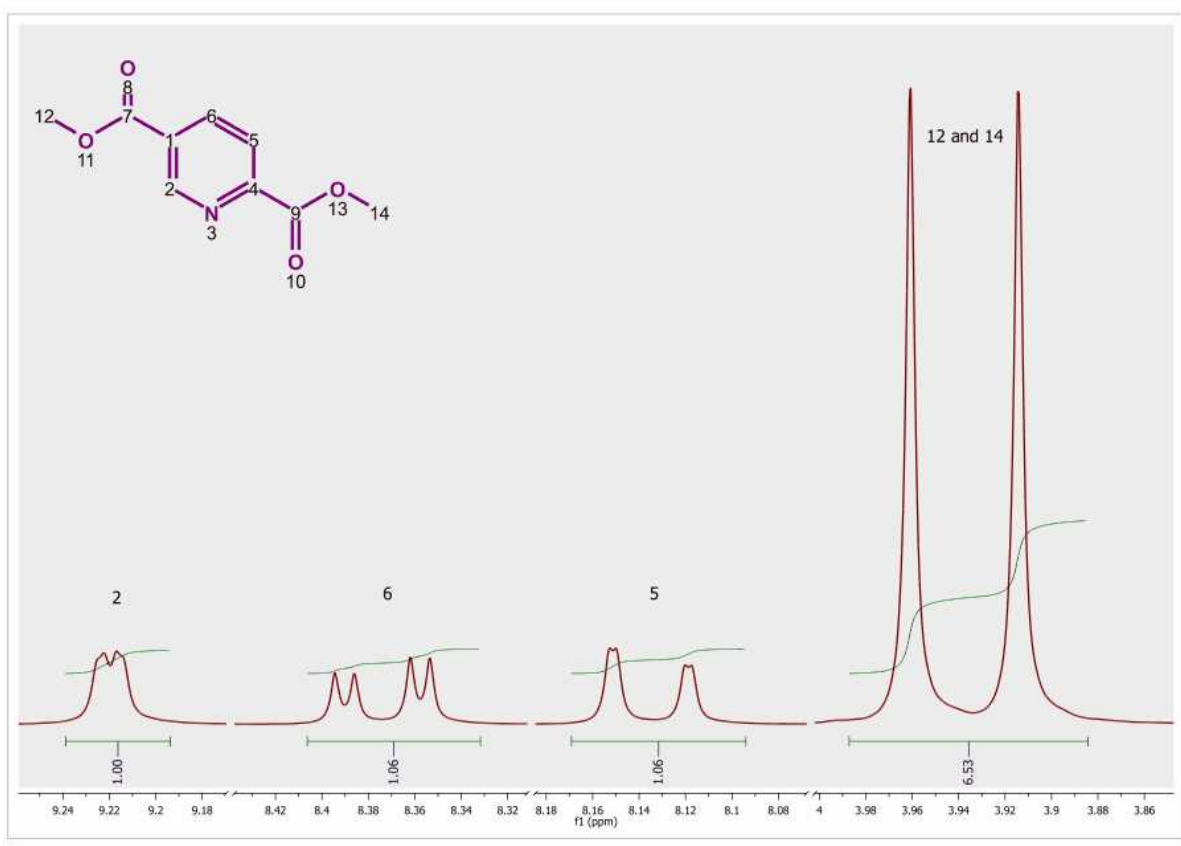

This spectrum has been processed without applying any weighting function and the resolution is **0.13 Hz/pt**. If we look at the signals corresponding to proton 2 in the structure, we can appreciate a small splitting due to 4 bond coupling with proton 6. Proton 6 shows a large splitting due to 3 bond coupling with proton 5 and a small splitting due to the 4 bond coupling with proton 2. Proton 5 appears as a

double doublet because of the 3 bond coupling with proton 6 and a small 5 bond coupling with proton 2. The latter is barely appreciated in the figure because of the lack of resolution. In fact, the same splitting should show in proton 2 but this can not be seen at this resolution level. It is important to remember that it is possible to measure couplings constants accurately when the splitting is much larger than the line width.

Following the menu 'Processing/Resolution Booster' will display the 'Resolution Booster' dialog box, where the user will be able to select the resolution degree of the algorithm:



Resolution Booster is sensitive to the line width of the signals. If a spectrum contains both narrow and broad lines, the algorithm could try to enhance the resolution of the sharp lines, but the negative side effect would be a potential removal of the broad lines.

Likewise, if we want to keep the broad lines, the resolution power of Resolution Booster should have to be reduced.

In the picture below you will be able to see the result of applying the **Resolution Booster** method by using the Normal Resolution:

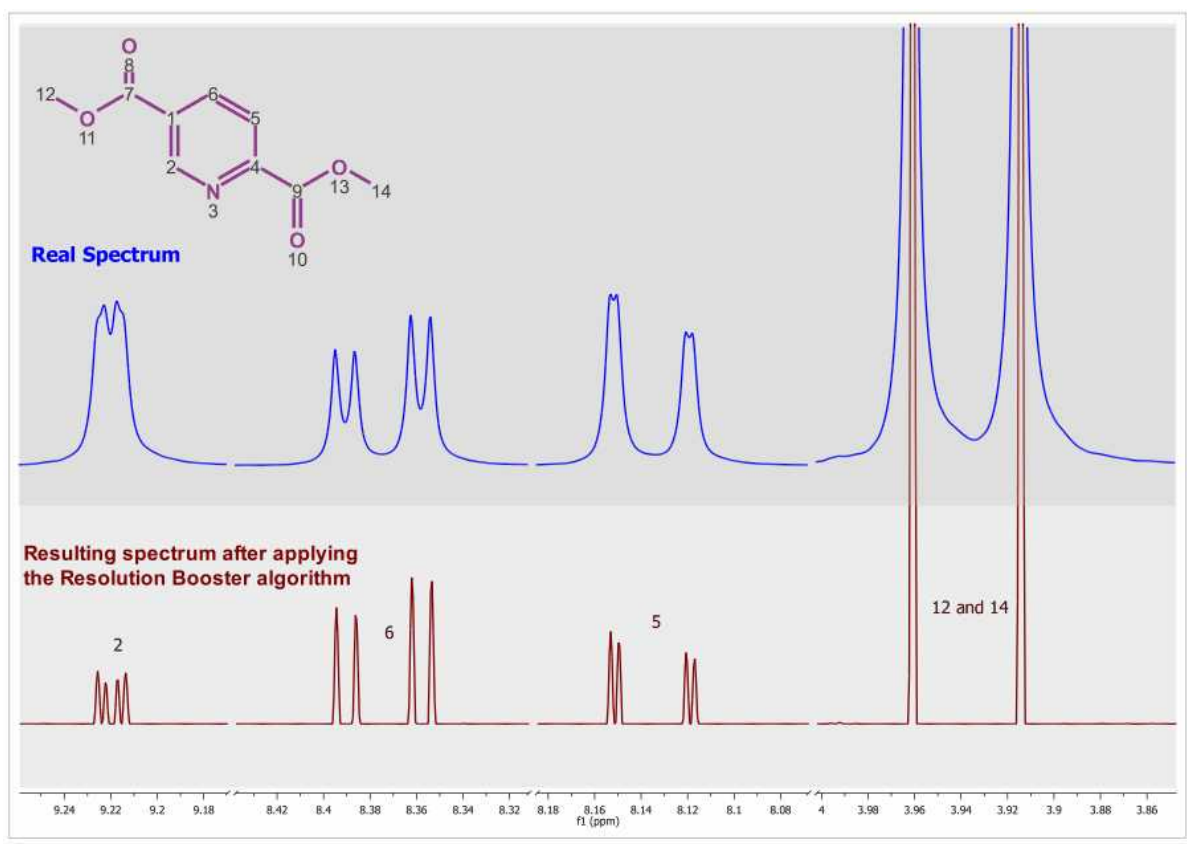

In this case, resolution has been increased by ~230% making possible the calculation of the weak, long range coupling constants.



Note:

It is important to notice that this procedure may change relative intensities. On isolated lines, in principle, it is approximately proportional to the second derivative which, when all lines have the same line width (as they often do) is proportional to the line height. However, broad lines can get suppressed and unresolved humps and shoulders get resolved (+) but their intensities and, to some extent, positions can not be trusted (-).

Please bear in mind that we can not integrate the spectrum after having applied Resolution Booster as this algorithm is sensitive to the signals linewidths. If all the lines in the spectrum would have exactly the same line width, Resolution Booster could also be considered a valid tool for qNMR analysis. But in real life, this is never true.

Thus, RB should be considered as a Resolution Enhancement tool which you can use for any of the following purposes:

- to measure chemical shifts & coupling constants more accurately
- to reveal signals which could otherwise be hidden and badly resolved because of spectral overlap

It is also possible to apply the Resolution Booster to 2D-NMR spectra.

See also:

<http://nmr-analysis.blogspot.com/2007/11/resolution-booster.html>

<http://nmr-analysis.blogspot.com/2007/11/selective-resoluton-booster.html>

<http://nmr-analysis.blogspot.com/2007/12/introducing-2d-resolution-booster-rb.html>

8.16 Inverting, Transposing and Reversing Spectra

Invert: The command 'Processing/Invert' multiplies all spectrum data points by -1. It is equivalent to applying a zero order phase correction of 180°. It is very useful for DEPT spectra.

Transpose (Not available in Mnova Lite): This command allows the user to transpose (by interchanging the rows and columns of the matrix) a spectrum for more convenient representation. This command is available by following the menu 'Processing/Transpose'.

Reverse Spectrum: The commands ('Processing/Reverse Spectrum') on this submenu allow you to reverse the spectrum along **F1**, **F2**, (horizontally or vertically) or **both axes** to obtain a more convenient representation.

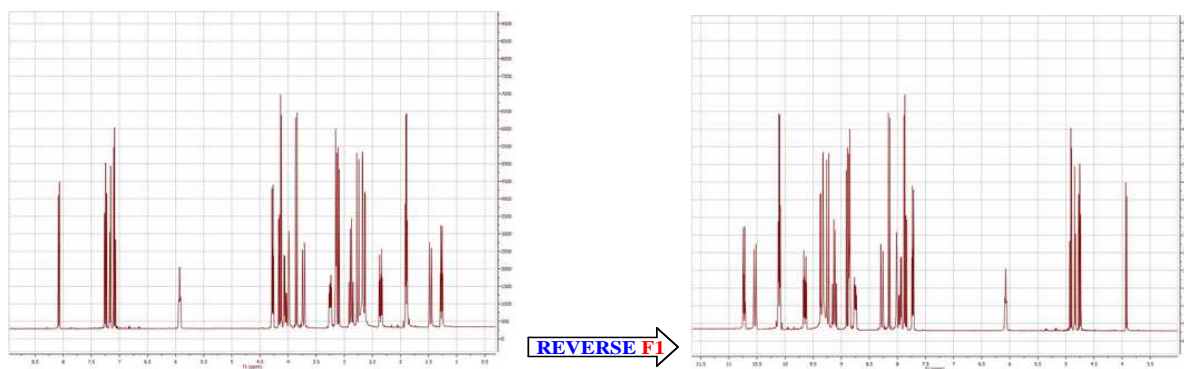

8.17 Processing Templates

Mnova includes a powerful and flexible feature which allows the user to easily automate the full processing of both 1D & 2D NMR data sets. This is ideal for the batch processing of spectra of the same type, and can also incorporate analysis operations.

For example, let's say you have acquired 20 proton spectra which you want to process using the same processing operations. The procedure is very simple:

1. Load one spectrum and [process](#) it as desired.
2. Go to **Processing/Processing Template**. The following dialog appears:

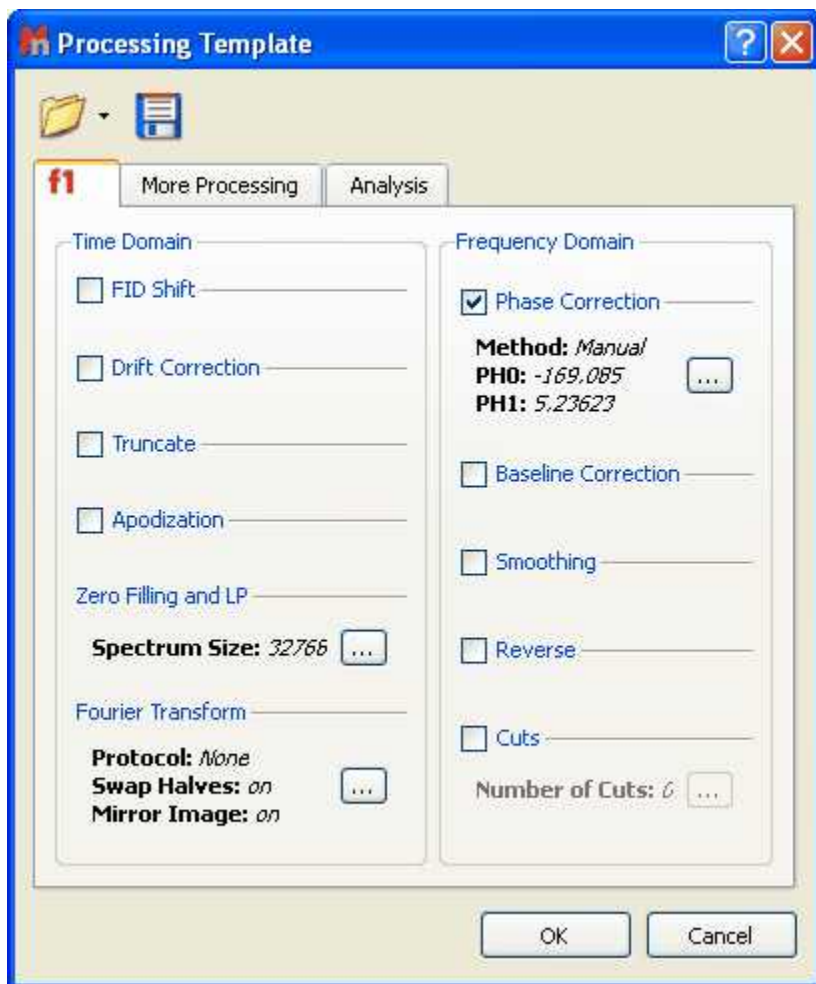

4. You can now apply this processing script file to any other spectrum/spectra by selecting the spectra you wish to process following this procedure (one or several spectra), and then opening the previously

saved file by using the open command in the Processing Template dialog box.



A few helpful tips ...

1. If you want to apply a processing script to all the spectra opened in one document, first select all the spectra in all the pages.
2. Next you can simply go to **Processing/Recent Processing Templates** and select the appropriate processing file script.
3. Remember that only spectra acquired using the same conditions should be processed using a processing script file. For example, if you have acquired a spectrum using a sequential mode and another one using simultaneous quadrature detection, you will get erroneous results.

It is possible to run a saved processing template by running this easy script:

```
//<GUI menuname="ApplyProcessingTemplate"shortcut="Ctrl+2"tooltip="Apply a saved processing tem
function ApplyProcessingTemplate()
{
var spec = new NMRspectrum( nmr.activeSpectrum() );
var processing = new String;
if (!spec.isValid())
return;
processing = "C:\\\\ProcessingTemplate.mnp";
nmr.processSpectrum(spec, processing);
spec.process();
mainWindow.activeWindow().update();
}
```

Part



9 Analysis Tools

This section will give you an outline of the features already implemented, and which will have full or at least partial capabilities in this version:

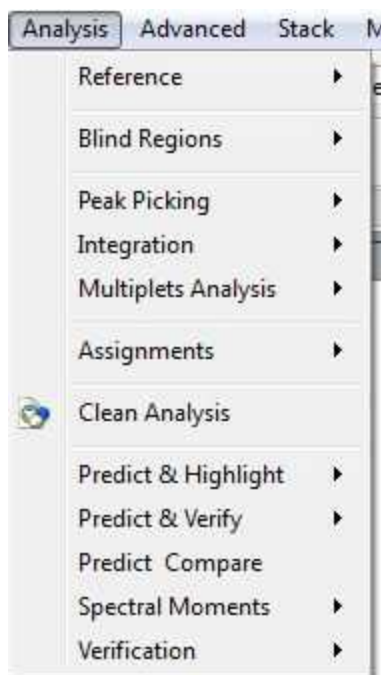

[Chemical Shift Referencing](#)

[Peak Picking](#)

[Integration](#)

[Multiplet Analysis](#)

[Molecular Structure](#)

[Assignments](#)

[Prediction of NMR Spectra](#)

The 'Clean Analysis' tool will delete all analysis features (peaks, integrals, multiplets) for the selected spectra as well as all assignments of the molecules linked with that spectrum.

9.1 Chemical Shift Referencing

In NMR, the frequencies are usually measured relative to a frequency standard. As these frequencies are strictly measured relative to a frequency standard proportional to the magnetic field, it is convenient to define the chemical shift as:

$$\delta = 10^6 \cdot \frac{(v - v_{ref})}{v_{ref}} = 10^6 \cdot \frac{\sigma_{ref} - \sigma}{1 - \sigma_{ref}} \approx 10^6 \cdot (\sigma_{ref} - \sigma)$$

Thus, in order to establish a chemical shift scale, it is necessary to choose some substance as a reference and define its chemical shift. In non-aqueous solvents, the most used reference substance is **TMS** (tetramethylsilane) which is defined to have a chemical shift of **0.0 ppm**. For biomolecules,

slightly different compounds (e.g. TSP, $(\text{CH}_3)_2\text{SiCD}_3\text{CD}_2\text{CO}_2\text{Na}$, Sodium-salt of trimethylsilyl-propionic acid) are used, since TMS is not soluble in water.

There are two way to reference your spectra, one graphically and another by using a dialog box.

The **Graphic Reference** (R as shortcut) will allow you to reference your spectra just with two clicks. Once click to select the position that you want to reference and another click to select the new chemical shift. This feature will be very useful to reference stacked spectra (for example):

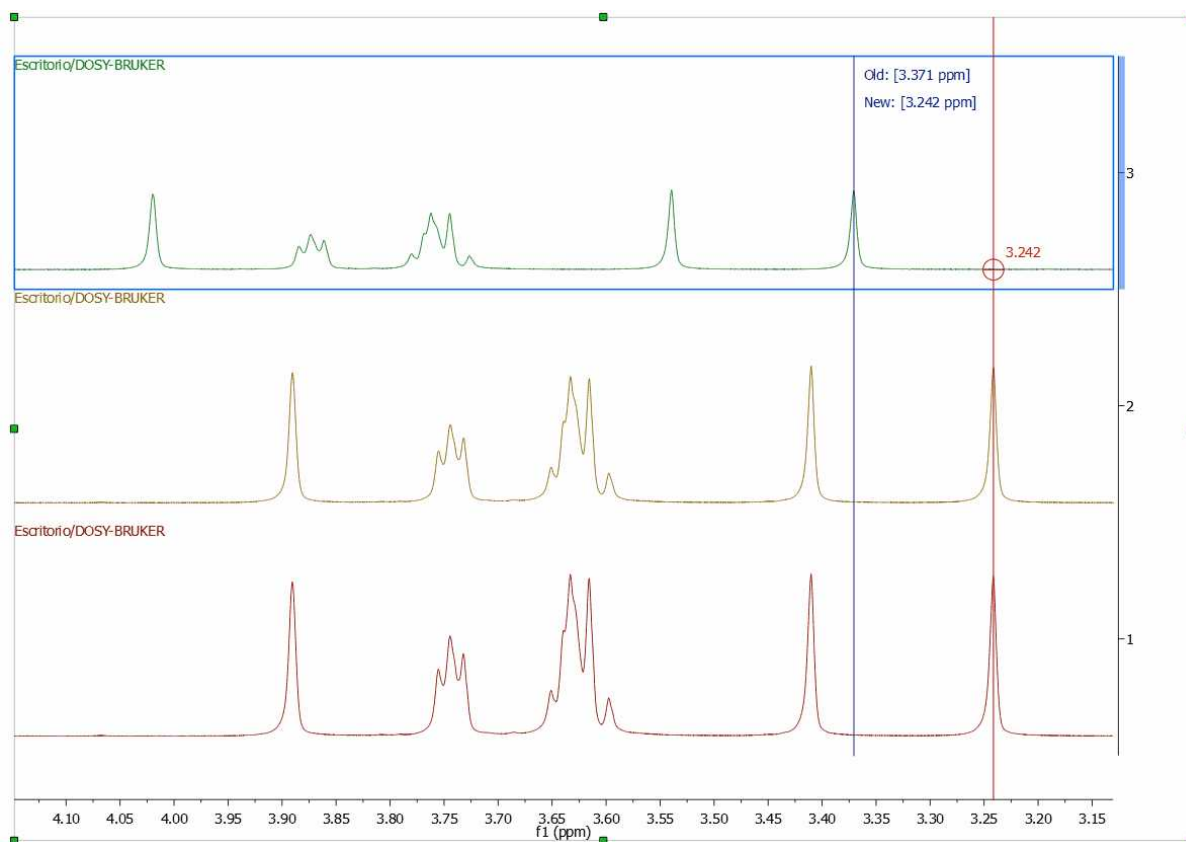

you can also use this toll to reference the 2D It is possible to reference 2D-NMR spectra directly with the 1D external trace. To do it just press the 'R' key, next click on the peak that you want to reference and finally click again on the new chemical shift (matching with the peaks of the external traces):

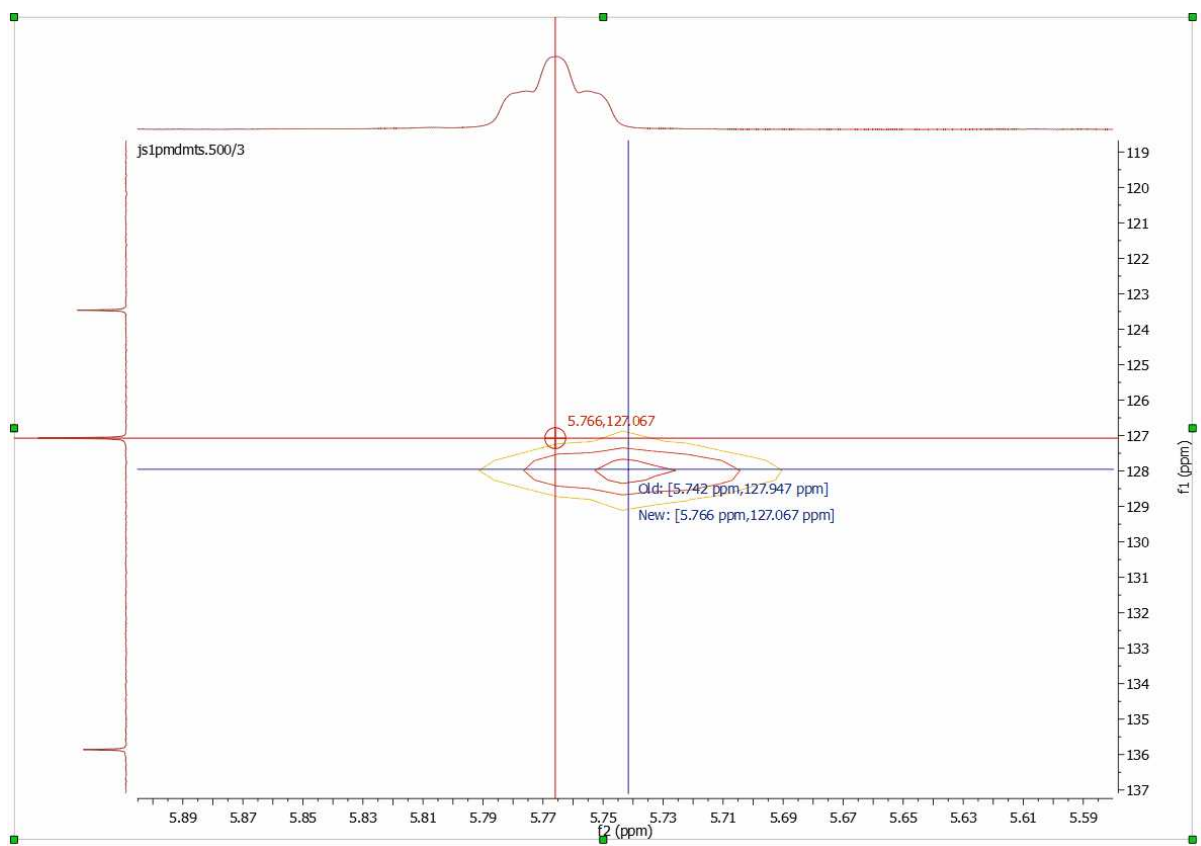

You can also calibrate your spectrum by selecting **Analysis/Reference/References** (L shortcut) on the main menu or by clicking on the  toolbar button and then following this procedure:

1. Zoom-in on the spectrum region containing the reference peak
2. Select the peak you want to be a reference point. You will notice that the mouse cursor automatically *jumps* to the peaks maxima. To select a peak at an arbitrary position which is not a local extreme (e.g. the shoulder of a peak), press **SHIFT** key, move the mouse to the desired position and click. The **following** dialog box appears:

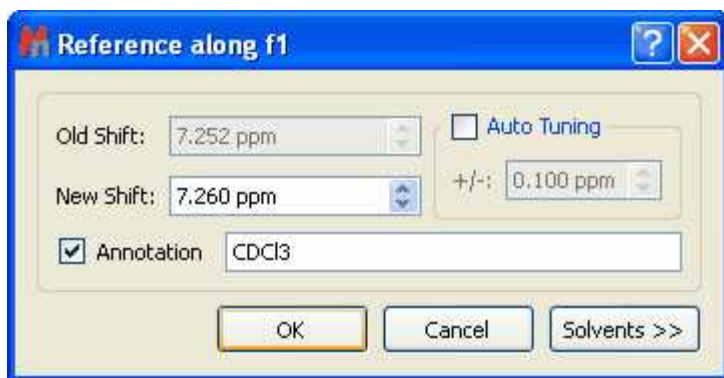

You will be able to type any annotation after having referenced your signal.

The 'Auto Tuning' option finds the maximum peak inside a limit and references it. This is very useful for example if you need to reference automatically a large amount of metabonomic spectra, where the

solvent peak could slightly change its shift with the pH of the sample.

Solvents >>

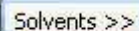
You can type the new value for that peak or you can click on the  button to get a list of solvent chemical shifts.

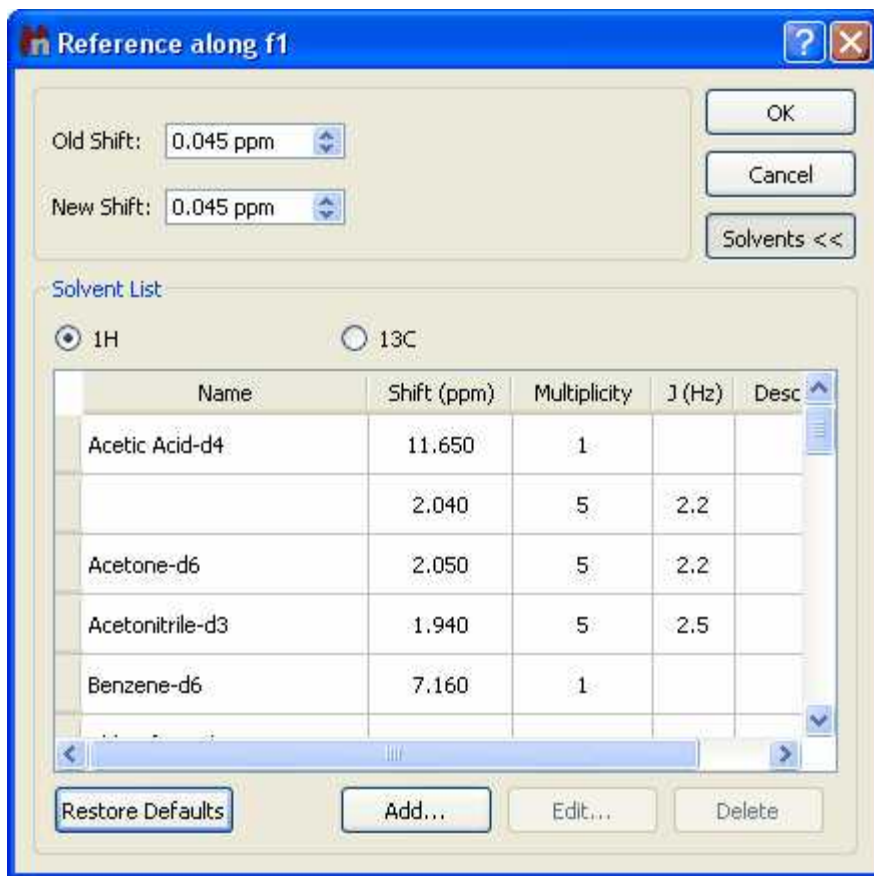

You can add new entries or edit the list of standard reference chemical shifts by using the buttons at the bottom of the dialog box.

9.1.1 Absolute Reference of x-Nuclei experiments

According to IUPAC, using a suitable secondary reference compound is no longer recommended. The unified scale is now the preferred method of referencing all spectra.

For example; in the past, the middle peak of the CDCl₃ 1:1:1 triplet at 77.0 ppm was often used to reference ¹³C-NMR spectra; but now the recommended method for ¹³C spectral referencing is the following:

1. Obtain a ¹H spectrum of the same compound, and set 0 ppm using the TMS resonance.
2. Determine ν_{TMS}^{obs} TMS from the ¹H spectrum.
3. To determine the absolute frequency of the 0 ppm position in the ¹³C spectrum, use:

$$\nu_C = \nu_{TMS}^{obs} \frac{\Xi_C}{100}, \text{ where } \Xi_C = 25.145020$$

4. Finally use ν_C as shown below to reference the ^{13}C spectrum.

Let's see how you can use the Absolute Reference in Mnova:

1st: Load into Mnova for example a 1H , ^{13}C and HSQC experiments and reference the solvent in the 1H dataset:

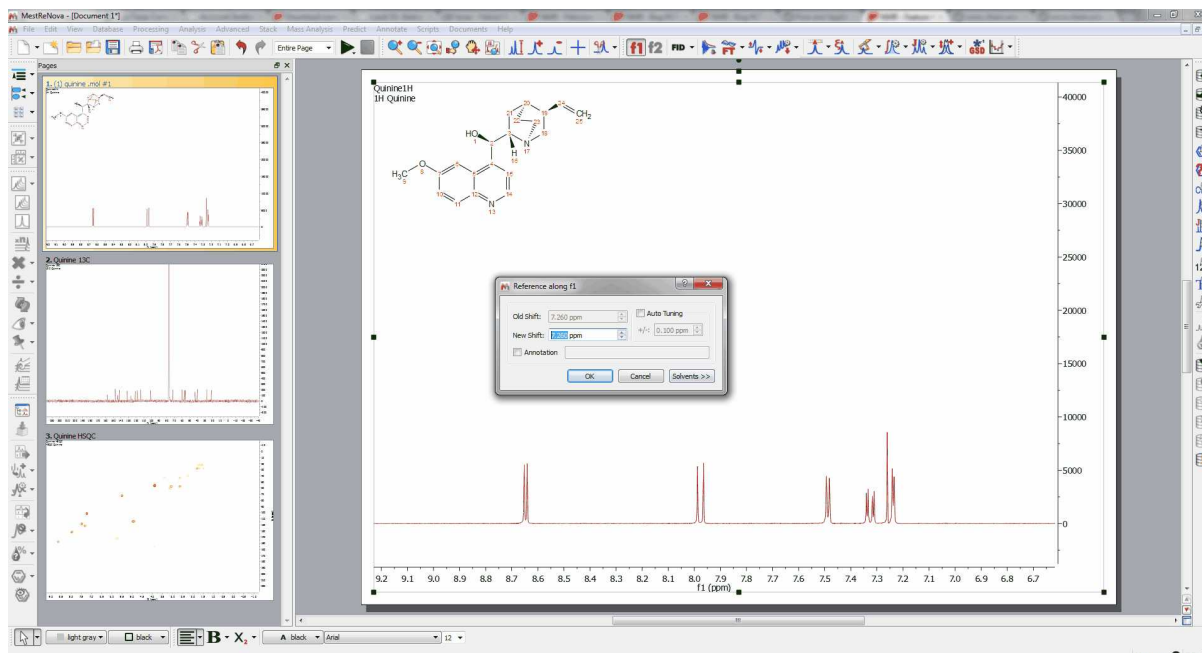

2nd: Click on the 'Absolute Reference' button of the toolbar  (or follow the menu 'Analysis/Absolute Reference') to display the applicable dialog box. Once there, select the 1H experiment as reference and check the boxes of the other experiments that you want to reference

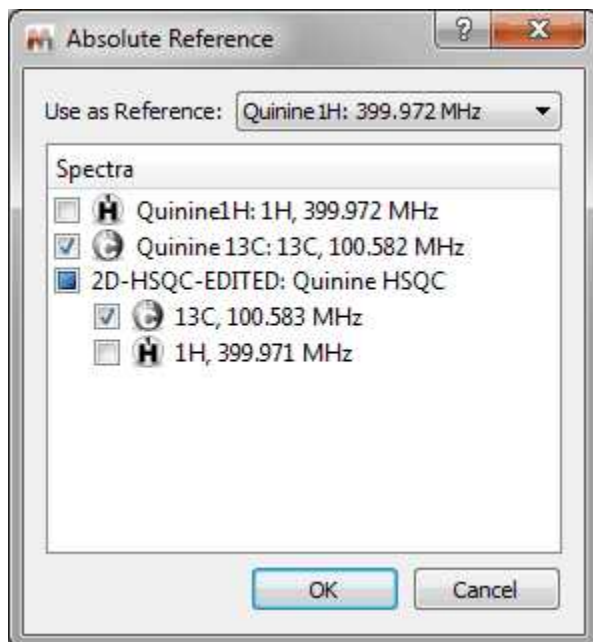

9.1.2 Reference of 2D-NMR spectra with the 1D external trace

It is possible to reference the 2D-NMR spectra directly with the 1D external trace. To do it just press the 'R' key (or follow the menu 'Analysis/Reference/Graphic Reference') to activate the **Graphic Reference** feature. Next click on the peak that you want to reference and finally click again on the new chemical shift (matching with the peaks of the external traces):

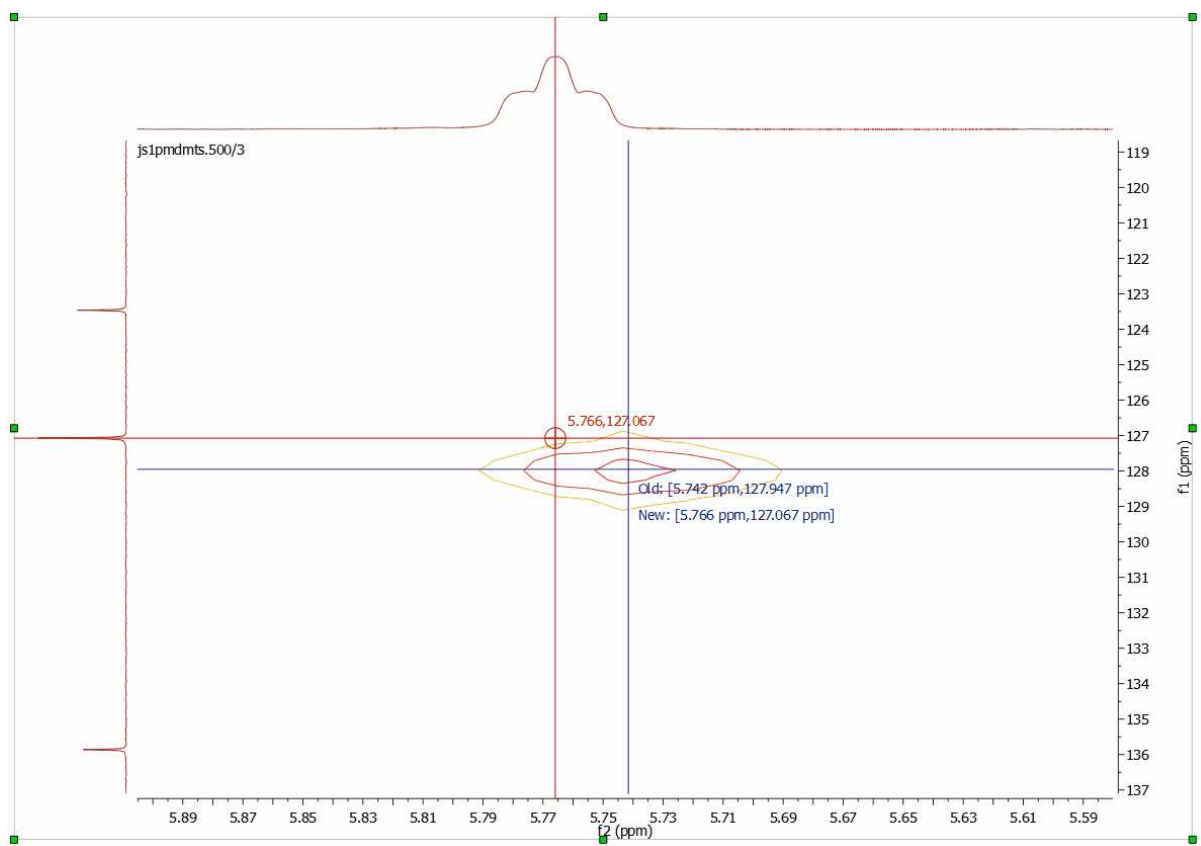

It will be also possible to do it automatically. To apply an automatic referencing, just right click over one of the traces and select 'Setup' to display the 'Setup Traces' dialog box. Once there click on the 'Use External 1H Trace as Reference' box':

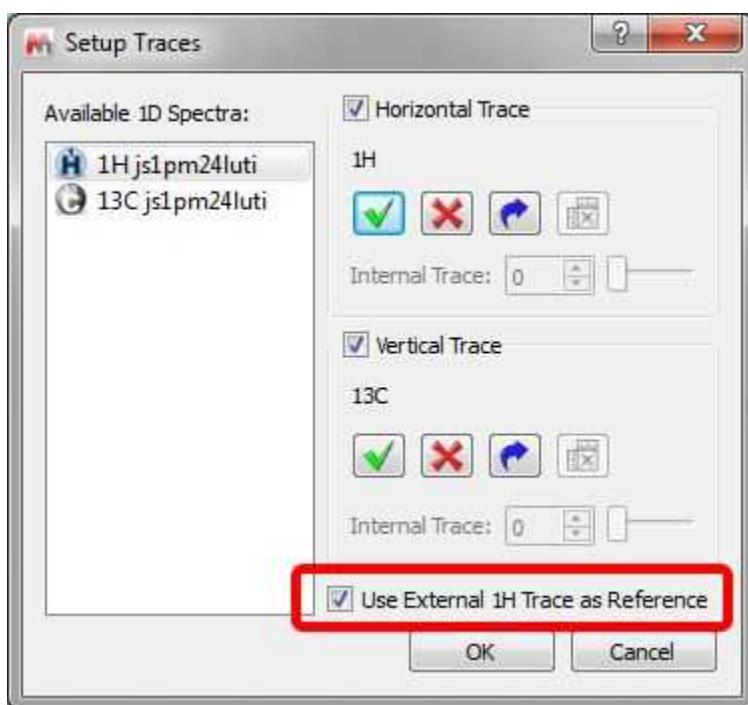

Let's see how this feature work with a unreferenced HSQC spectrum (with a 1H and 13C datasets as [external traces](#)):

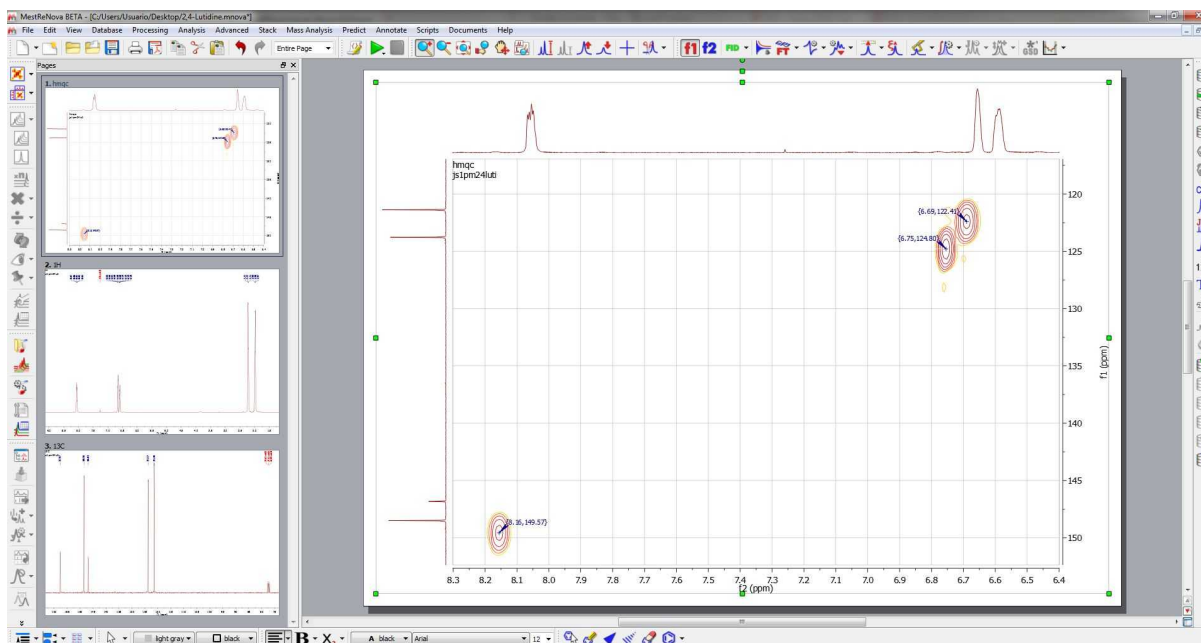

As you can see, this spectrum is not referenced. To apply an automatic referencing, just right click over one of the traces and select 'Setup' to display the 'Setup Traces' dialog box. Once there, check on the 'Use External 1H Trace as Reference' **box** (highlighted in red in the picture below):



Automatically, you will obtain your HSQC spectrum referenced, as you can see in the screenshot below:

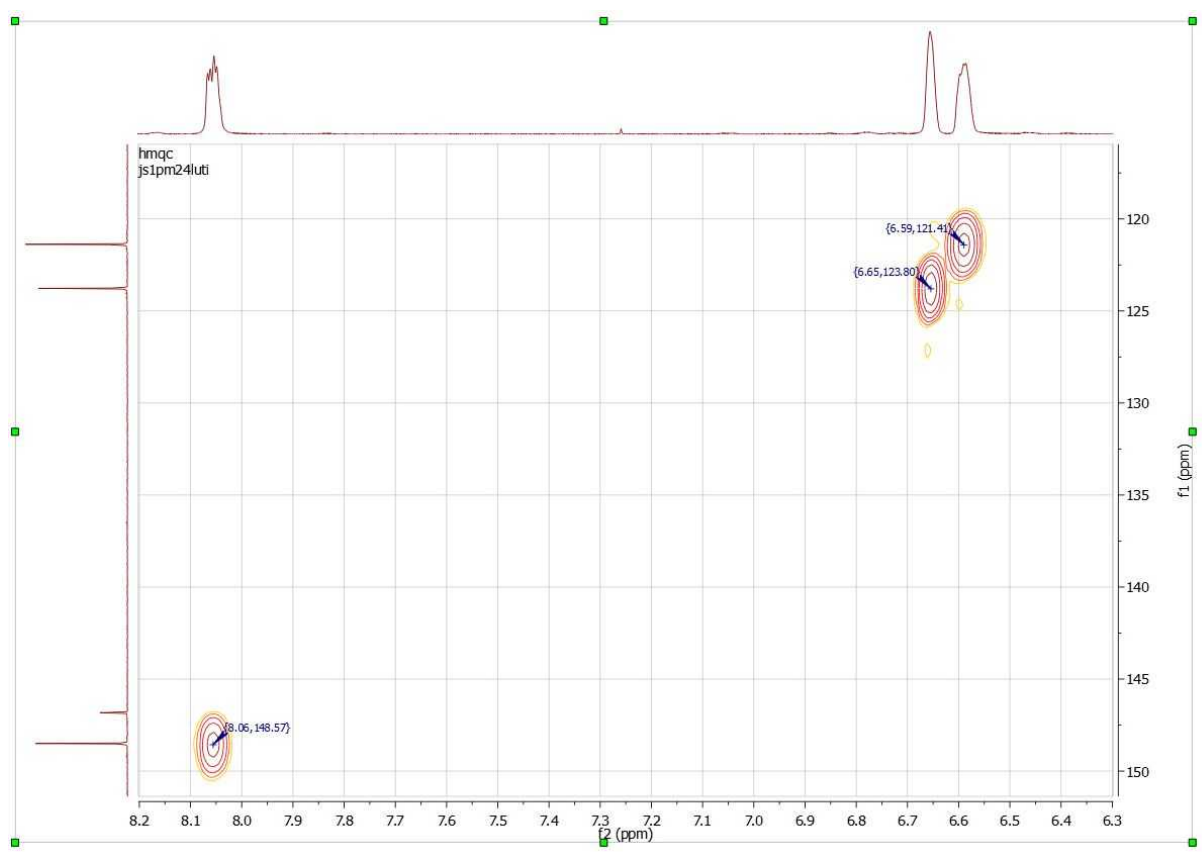



9.2 Blind Regions

This feature will be used to select regions from your spectra which will be skipped by the automatic phase correction algorithm and analysis algorithms such as integration, peak picking or multiplet analysis. Conversely, blind regions will not be saved or searched in the Database. This will allow users to ignore areas of the spectrum which present particular challenges, whilst still being able to use the rest of the information in the spectrum (for example, ignore non-phasable signals in solvent suppressed spectra when doing quantitation).

You will be able to select the Blind Regions by following the menu 'View/Blind Regions/Add Blind Region' and clicking&dragging on the regions of interest.

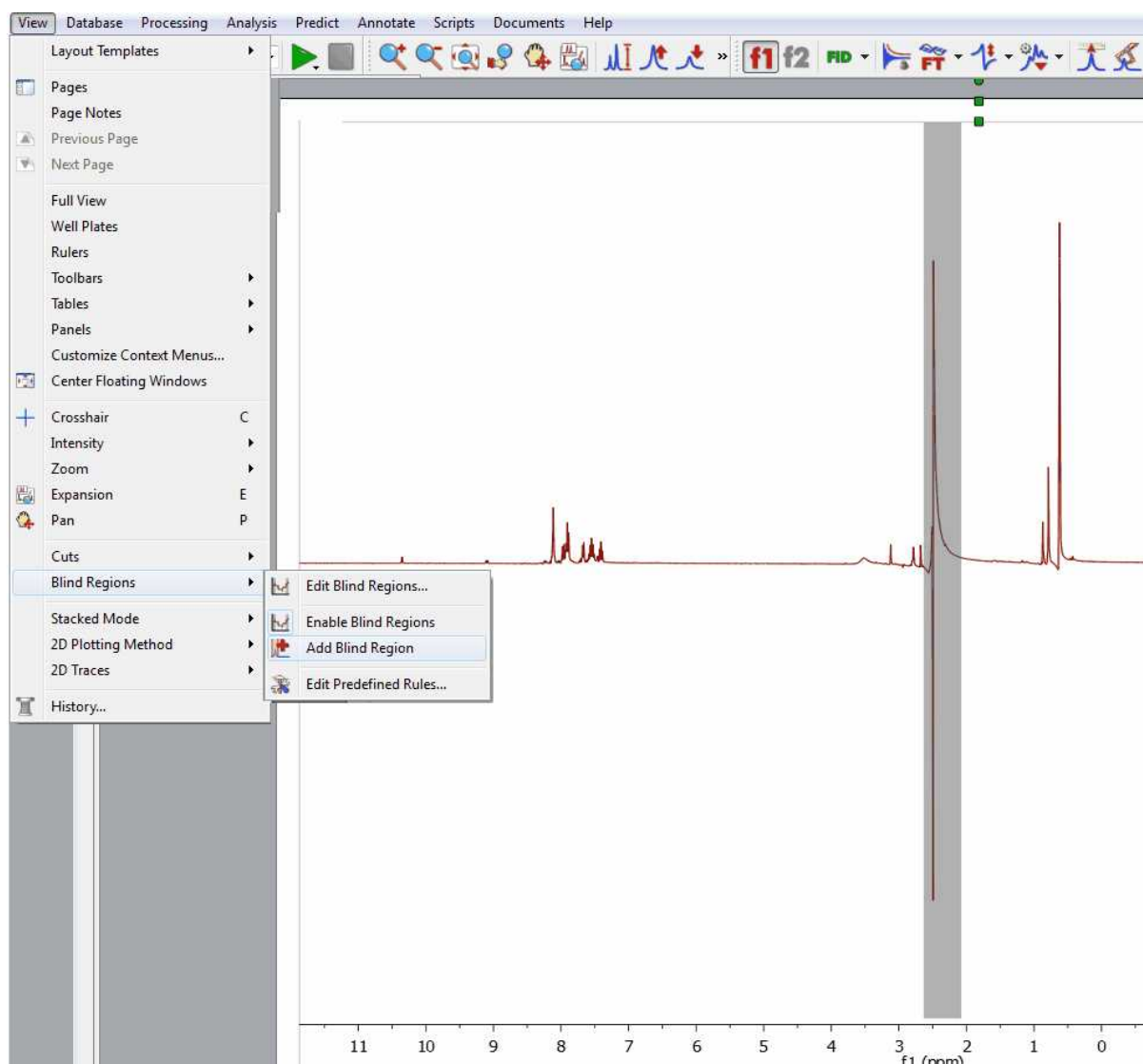
In the example below, you can see how we have added a blind region to the dispersive signal of the water in order to apply an automatic phase correction to the spectrum without taking into account that signal. We can get similar results by using the [cutting tool](#) (to hide the solvent signal):



Selecting the 'Edit Blind Regions' will display a dialog box which will allow you to save the regions, to load another 'blind regions' file, to enable/disable the highlight of the blind regions  or to add

additional blind regions :

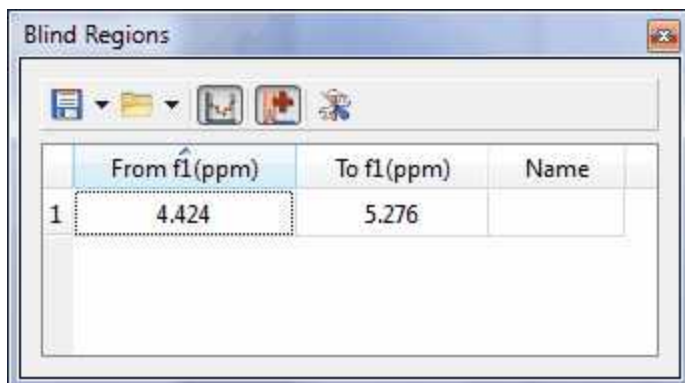

Right clicking on any cell of the table will allow you to delete or disable the applicable blind region.

If you have previously saved any blind regions, you can use it as 'Predefined Rule' :

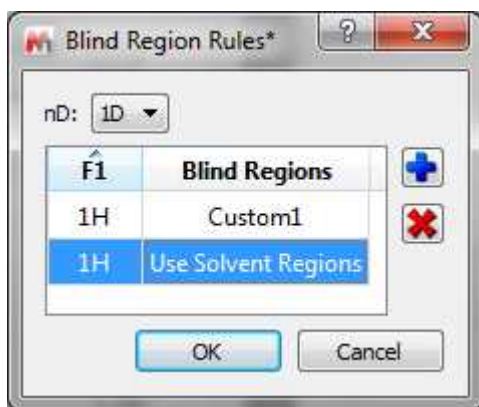

Clicking on the 'Open scroll down menu, you will be able to open any saved regions (including some templates for the common solvents by default).

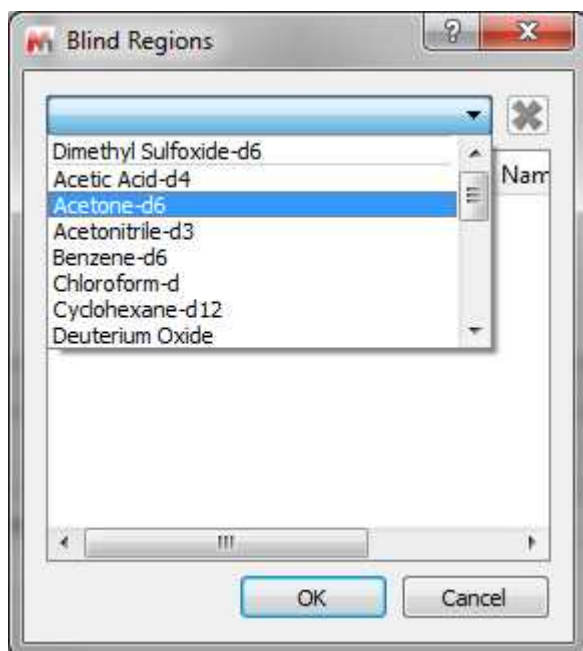

Selecting the 'Import' option in the 'Open' scroll down menu, will allow you to load XML files containing the blind region limits.

9.3 Peak Picking

Mnova implements a series of peak picking algorithms for 1D and 2D. These algorithms can be accessed via the menu item 'Analysis/Peak Picking' or via the scroll menu immediately to the right of the '**Peak Picking**' icon  on the toolbar. This scroll menu will allow you to use **Automatic** Peak Picking, **Manual** Peak Picking (Manual Threshold), **Peak by Peak** Peak Picking, Move Peaks, Auto Classify Peaks (as compound, impurity, solvent, artifact, etc), create a new synthesized spectrum, to show or not show peaks on screen, to delete all peaks or delete peaks one by one, to set Peak Picking Options and to report the peak list, etc.

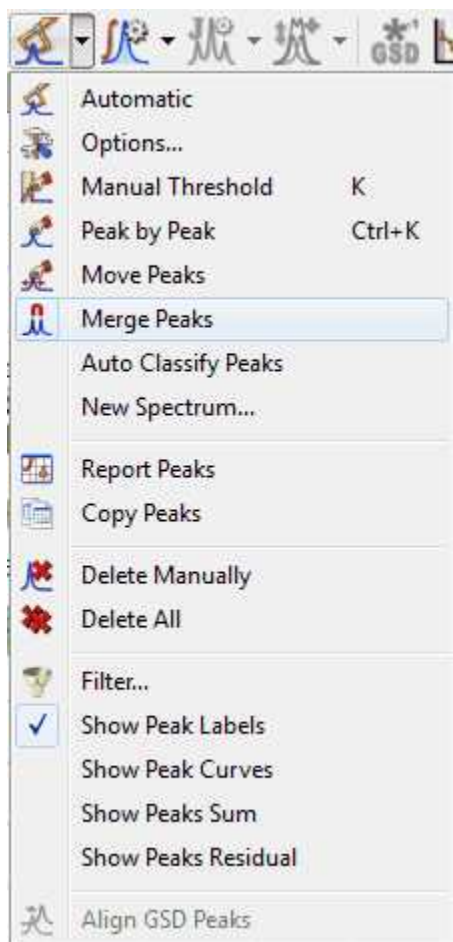

It will be possible to move the peaks labels up and down just by clicking and dragging.

Automatic Peak Picking

The Automatic Peak Picking option can be launched by simply clicking on the '**Peak Picking**' icon  on the toolbar. This algorithm will peak all the peaks in the spectrum, and, by default, show **them** on screen with automatic recognition of the solvent lines. This algorithm can be applied indistinctively to both 1D and 2D spectra.

Example 1: 1D Peak Picking

This is a major change to Mnova NMR functionality. The default automatic Peak Picking algorithm is now based on **GSD**, rendering enhanced resolution, identification of overlapped peaks and also including autodetection of solvent and impurities (this algorithm is slower than the Standard, so if you are not interested in the deconvolution, you may prefer to use the Standard algorithm. See [options](#) below)

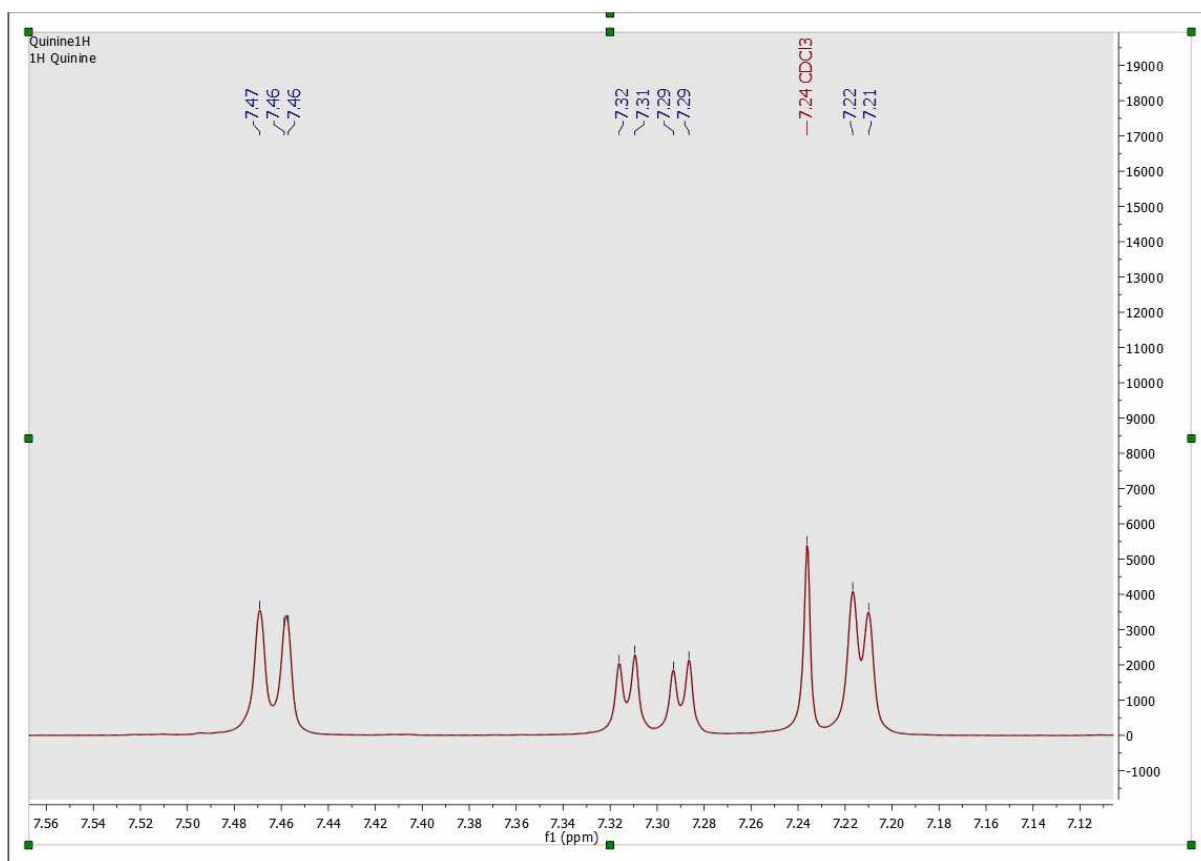

You can see above an example of the autoediting capabilities in the new algorithm, which automatically identifies solvents (as well as impurities, reference peaks, etc).

You can see below another example of the enhanced resolution achieved by the new Peak picking algorithm, now capable of identifying shoulders on large peaks as smaller peaks and of labelling and include them in multiplet analysis.

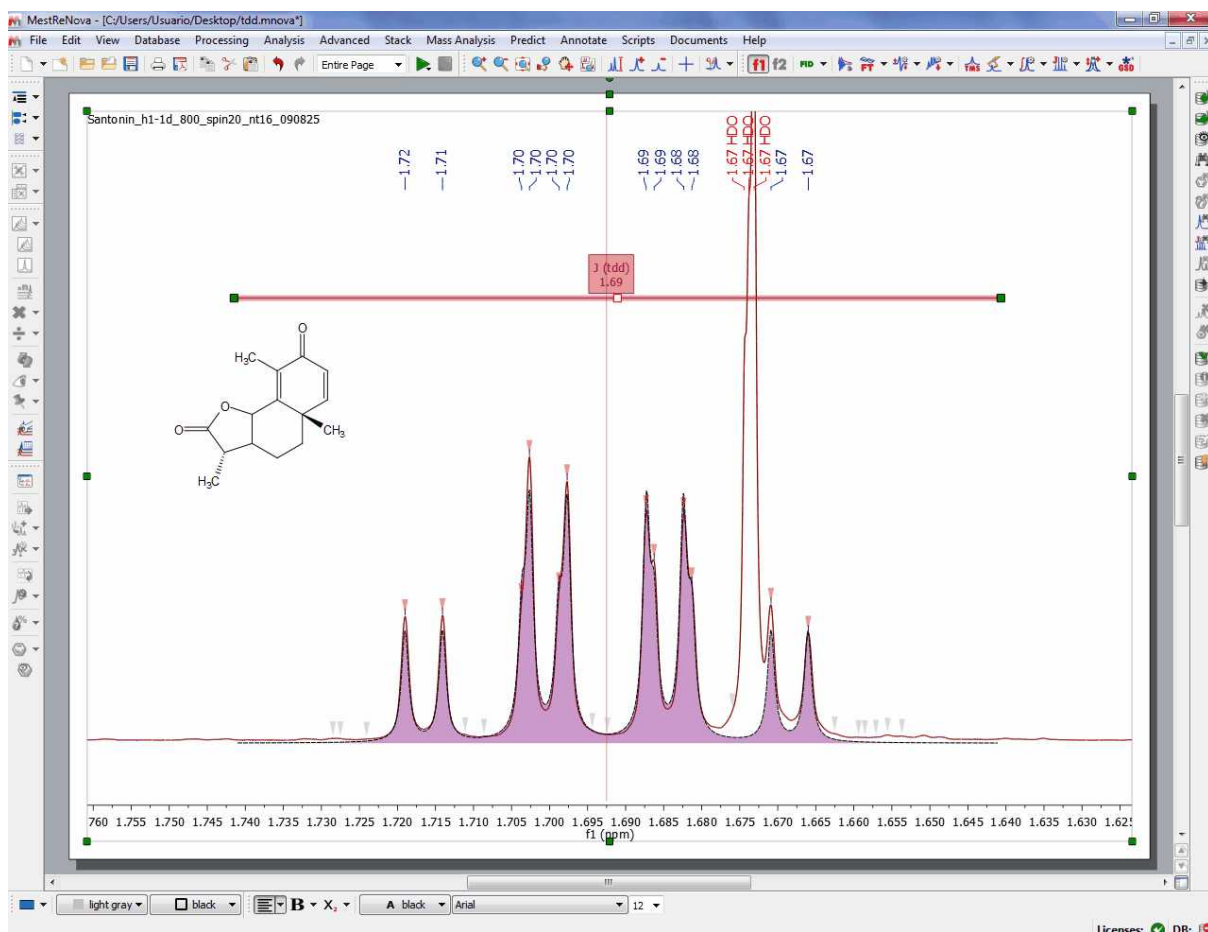

Peak curves are now active objects which can be interacted with, and three-way highlighting of peaks table, peak labels and the peak themselves has been implemented. For example, double clicking on any peak label will display the 'Peaks Table', hovering the mouse over the peak label (or on any table) will highlight the peak in the spectrum and allow the user to interact directly with that peak. Clicking on any peak of the spectrum will automatically **scroll up/down the table** to the position of currently highlighted peak in the spectrum. **Right clicking** on any peak, will allow you to change the '**Peak Type**' from the 'Peaks context' menu.

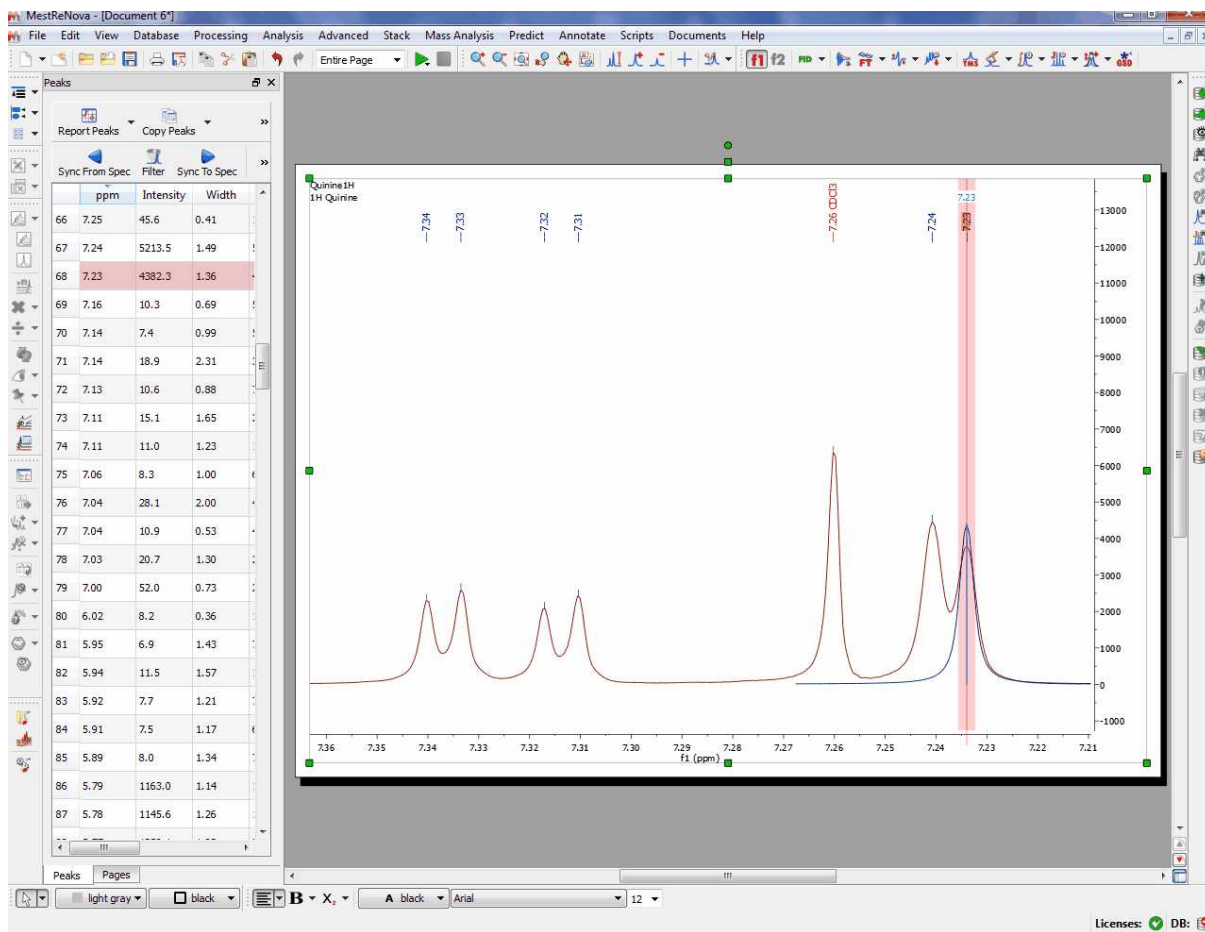

If your document contains more than one compounds, you will be able to select the applicable compound for each peak by right clicking on the peak label (or by selecting the peak(s) from the Peaks Table) and selecting 'Set Compound':



Example 2: 2D Peak Picking

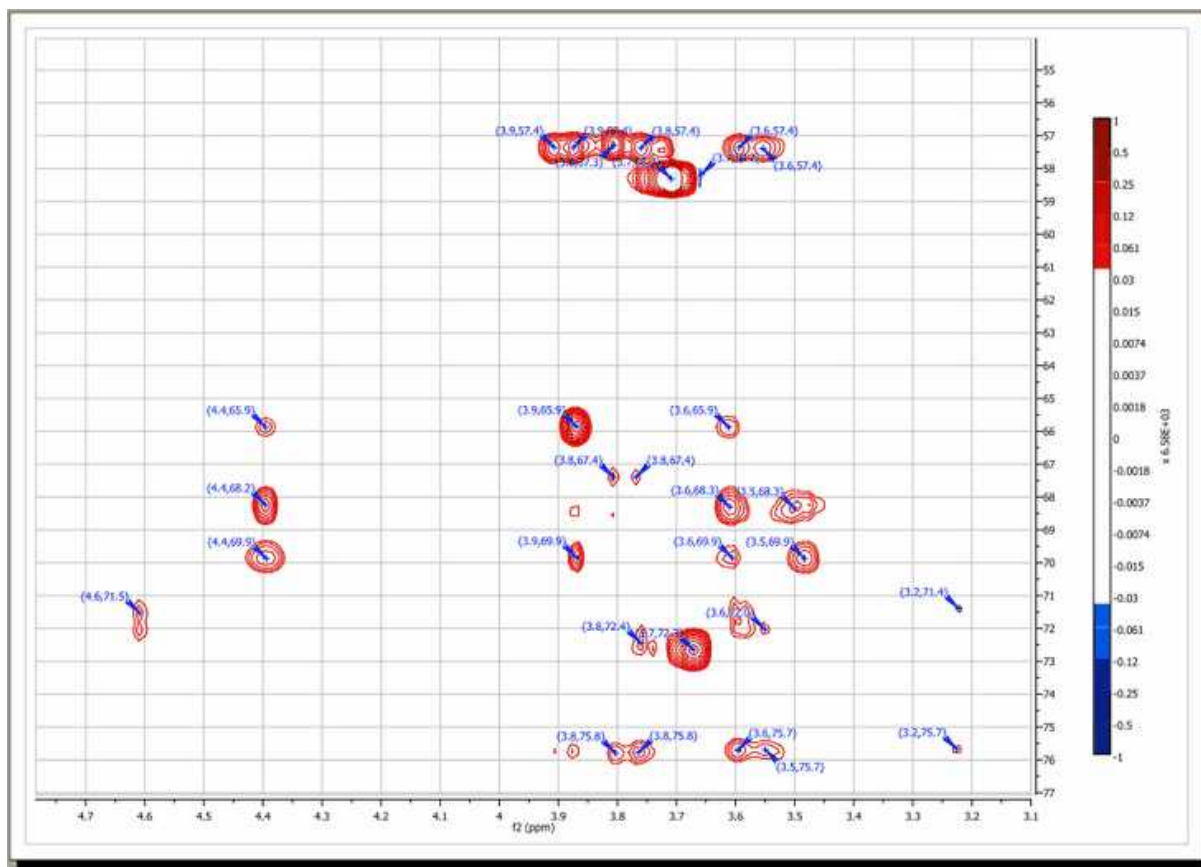

9.3.1 Peak Picking Options

Mnova has two Peak Picking algorithms: GSD (by default, with global spectral deconvolution and slower than the Std) and Standard (without deconvolution, faster than GSD).

GSD Peak Picking options:

The Peak Picking based on [GSD](#) (Global Spectral Deconvolution) will have these options:



GSD has different operational levels, ranging from a very fast but inaccurate method to slower but much more accurate levels. In addition, GSD makes it possible the automatic recognition of solvent peaks, impurities, etc. We recommend to use a GSD level of 1 (flash) or 2.

From this menu we can set the Refinement Level (number of cycles), additional Refinement (splittings), the Resolution and the 'Auto Edit' of the GSD peaks. Clicking on the 'Set as Default' button will store these settings in the registry for the future analysis.

The 'Refinement Level' will be the number of GSD fitting cycles applied over the spectrum. For example if you select 2 cycles, that means that the program will apply a GSD to your original spectrum and then another to the deconvoluted spectrum. GSD has different operational levels, ranging from a very fast but inaccurate method to slower but much more accurate levels. We recommend to use a GSD level of 1 (flash) or 2.

Additional Refinement - Splittings: to define the signals as composite signals (of several Lorentzian signals) in order to reduce the residues of the fitting.

Resolution: GSD is sensitive to the line width of the signals. If a spectrum contains both narrow and broad lines, the algorithm could try to enhance the resolution of the sharp lines, but the negative side effect would be a potential removal of the broad lines. Likewise, if we want to keep the broad lines, the resolution power of GSD should have to be reduced.

'Auto Edit': the program will try to identify the type of each signal of the spectrum (compound, solvent, impurity, etc). This information will appear in the 'Type' column of the GSD Peaks table.

Standard Peak Picking options:

This algorithm is much faster than GSD, but it does not include deconvolution.

A series of options can be controlled on the 'Peak Picking Options' dialog box, which can be accessed via the Peak Picking scroll menu. The user can choose the 'sensitivity' (the higher the value the less peaks will be picked), the 'peak type', whether to 'use parabolic interpolation', 'Noise Factor' (intensity threshold) merging options for 2D multiplets, maximum number of peaks, etc. All these options can be evaluated interactively, so that their results can be viewed on screen in **real time**, by making sure the

'Interactive' box is selected.

- **Sensitivity:** it is basically a kind of smoothing parameter. For example, in noisy spectra, large values of this parameter will smooth the spectrum in the background so that less peaks will be detected. By default, this value will be 1 which means that the program will try to find the maximum number of peaks in the spectrum. This is the recommended value for routine 1D spectra.

The sensitivity factor is indeed being used by the program and its main application is to avoid the detection of too many peaks in noise spectra. As we said above, this option can be considered as a smoothing parameter which is somehow applied before the peak picking algorithm is applied. For instance, if you have a very noisy peak with a lot of local extrema caused by the random fluctuations of the noise, the peak picking algorithm could find just too many peaks which do not correspond to real peaks, just noise local maxima/minima. In order to avoid that situation, the sensitivity factor can be increased in such a way that the peak is smoothed on the fly and ideally, only the real peak would be detected.

For example, this is what happens with a very low value for the sensitivity in a noisy spectrum:



And this is the result when a higher value is used:



It is shown below, how this sensitivity factor is being used by the program by opening a 1H-NMR spectrum of strychnine. First you will see the result with sensitivity = 1 (BTW, it's important to realize that the sensitivity factor can be lower than 1. The lower the value, the higher the resolving power of the algorithm):

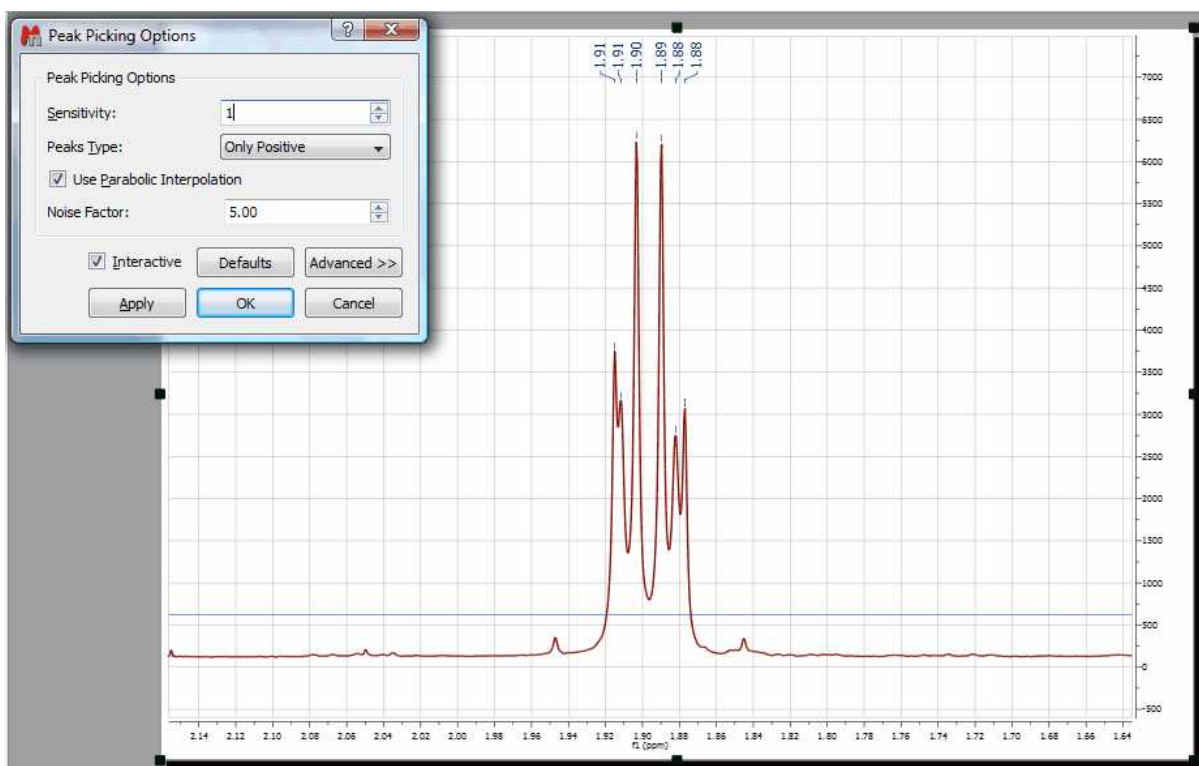

So you can appreciate that with sensitivity =1 all peaks have been detected. Now let's increase the value to 10. This is the result:

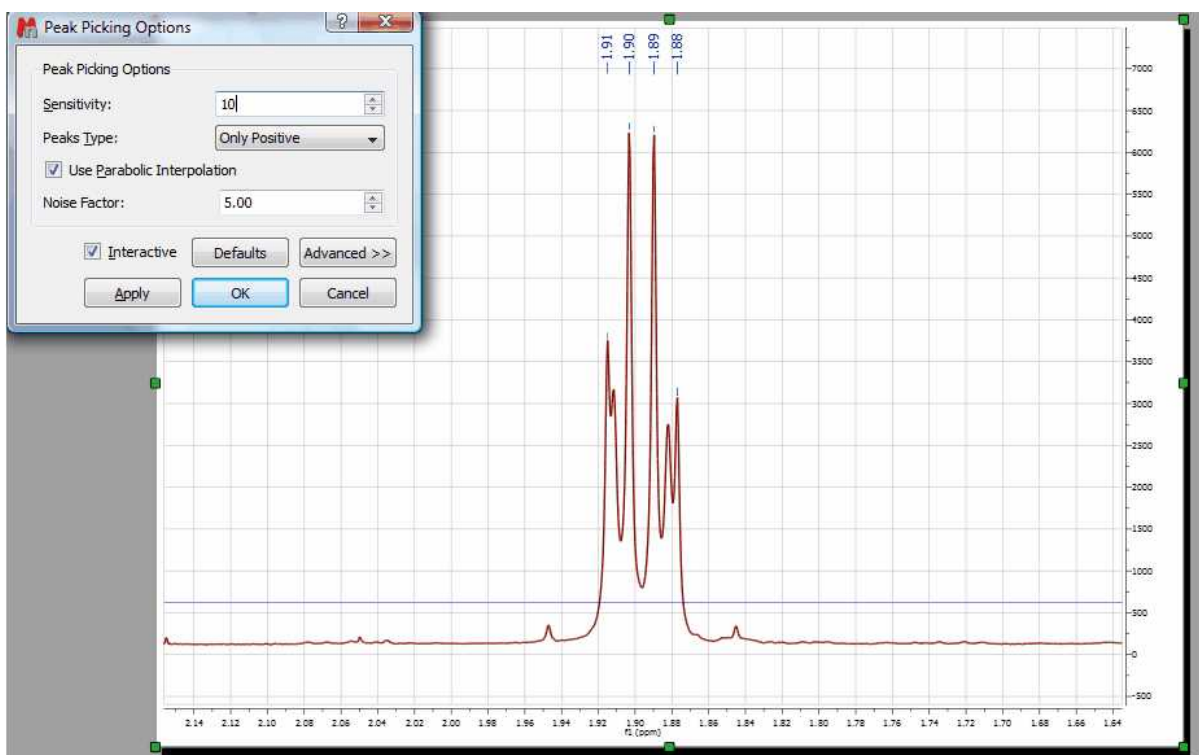

You can see that only 4 peaks have been detected whilst 2 less resolved peaks are missing now.

- **Noise Factor:** it is a kind of intensity threshold. The program will automatically calculate the noise value of the spectrum. This noise value is then multiplied by the noise factor. After running the peak picking algorithm, peaks smaller than the noise value multiplied by the noise factor will be rejected. The program shows this vertical threshold as two horizontal lines in the spectrum, as you can see in the picture below:



Manual Peak Picking

The Manual Peak Picking option allows the user to set an area of the spectrum where the software will carry out the Peak Picking, by simply left clicking and dragging the mouse over the area.

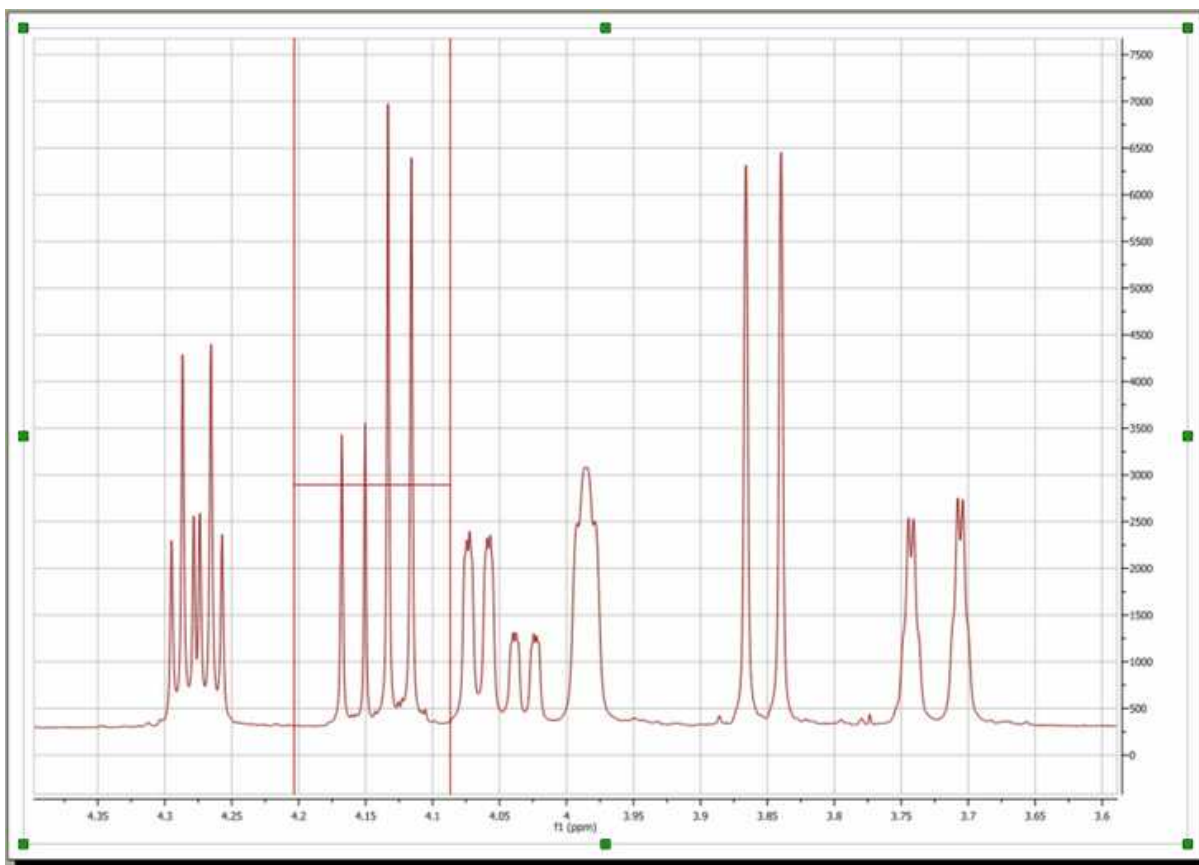

This will generate a bucket, and all peaks with chemical shifts between the left and right hand sides of the bucket and with intensities above the bottom of the bucket will be picked.

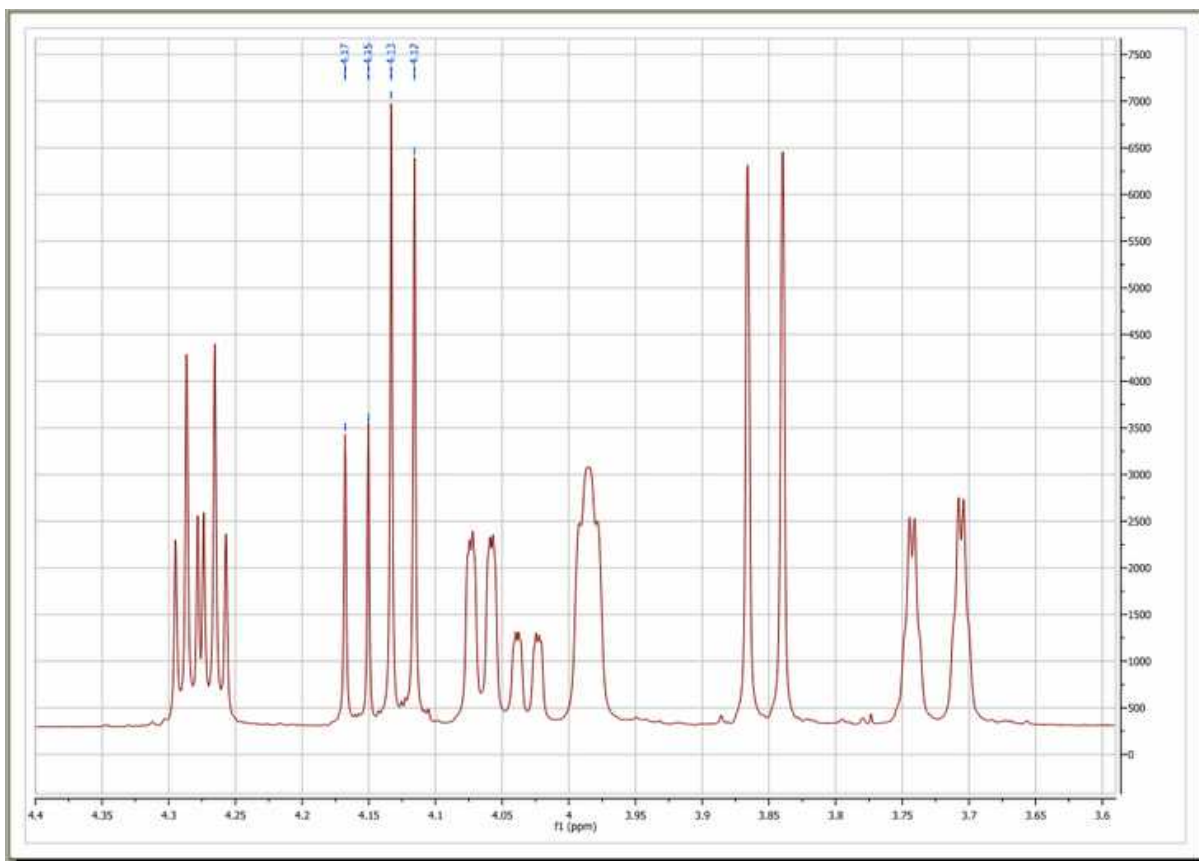

Peak by Peak

The Peak by Peak option will allow you to hover the mouse over specific peaks of interest and to only select those for the peak picking output, by just left clicking on each one at a time. The procedure is very simple: just point to the peak you want to pick so that it is highlighted and then left click on the mouse.

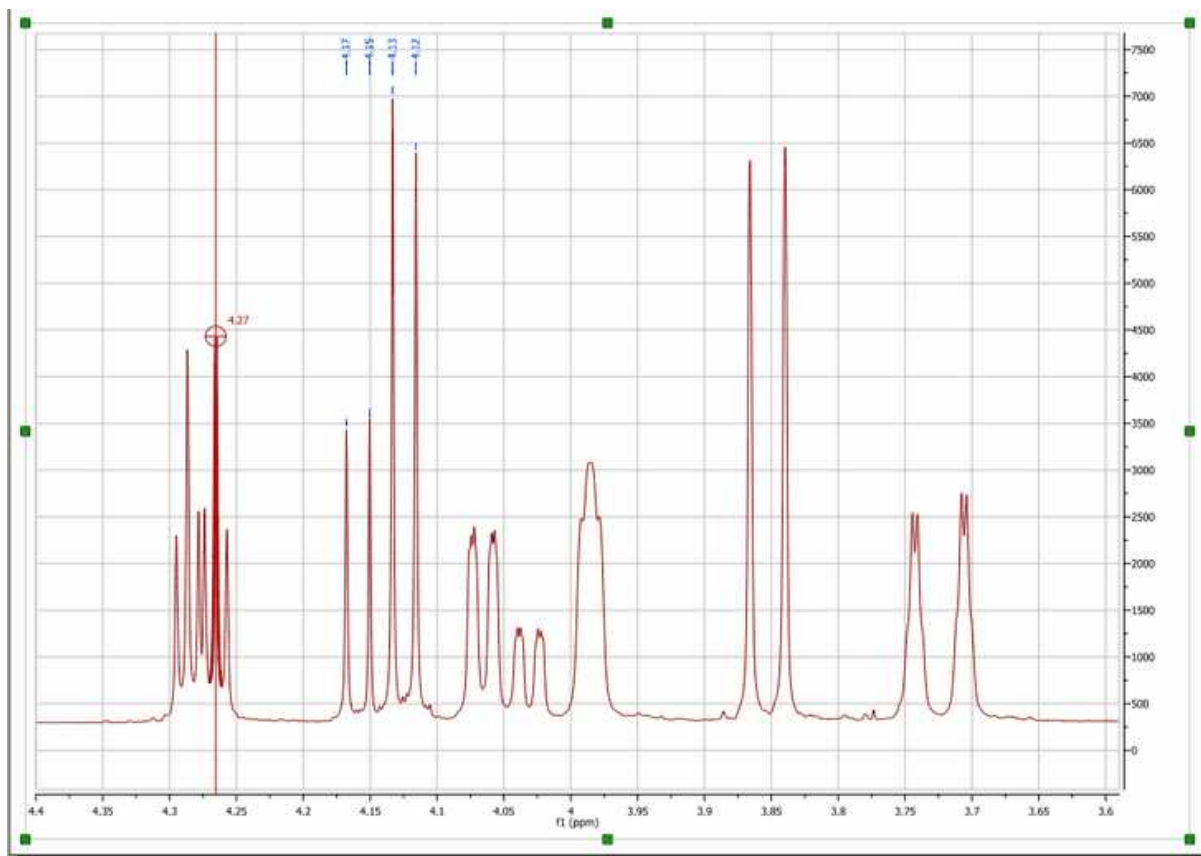

Note that, by default, Mnova will find the peak top by using parabolic interpolation. To pick a peak at an arbitrary position (e.g. not at a local extreme), press <Shift> and click.

Mnova also allows the user to **move a peak label** to a new location, by using the 'Move Peaks' tool under the Peak Picking scroll down menu.

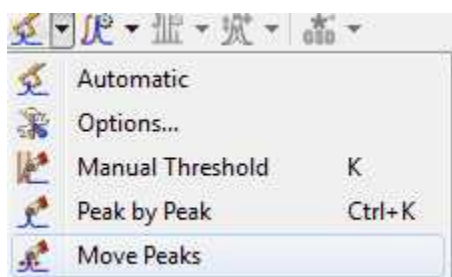

Note: When a peak is moved its Annotation information remains unchanged, although other info such as peak widths and intensities are updated.

It will be possible to **merge peaks** (very useful for 2D) just by selecting the applicable option in the Peak Picking scroll down menu and clicking and dragging on your spectrum:

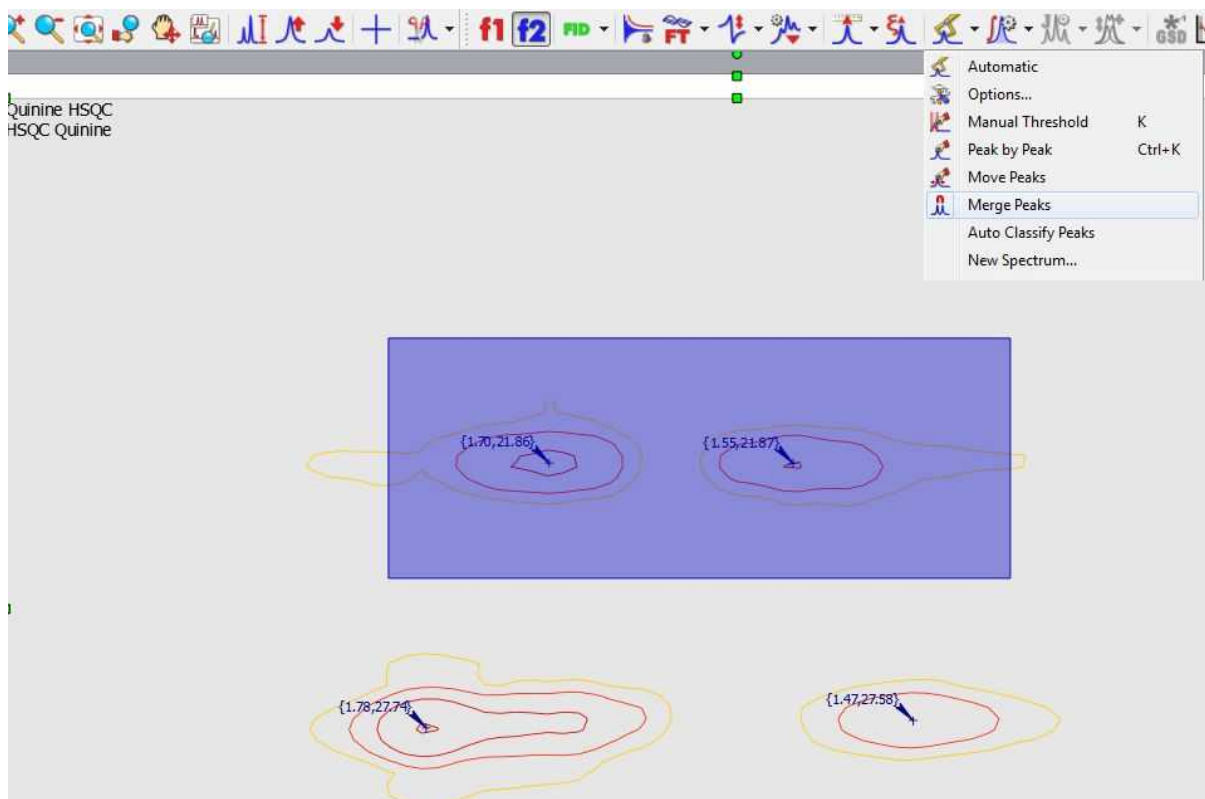

Once you have finished with the 'Peak Picking', select the 'Report' option in the Peak Picking scroll down menu.



It is also possible to copy the report to the clipboard, by selecting 'Copy Peaks' in the scroll down menu.

It will be possible to select the peak report template for the 'Peak List' just by selecting 'Setup' in the 'Report Special' scroll down menu of the ['Peaks Table'](#).

Filter Peaks

From the Peak Picking scroll down menu (or from the Peaks table), it will be possible to apply some filter to show for example only Compounds Peaks. If the spectrum contains peaks belonging to more than one compound, we can show only the peaks assigned to one of them:

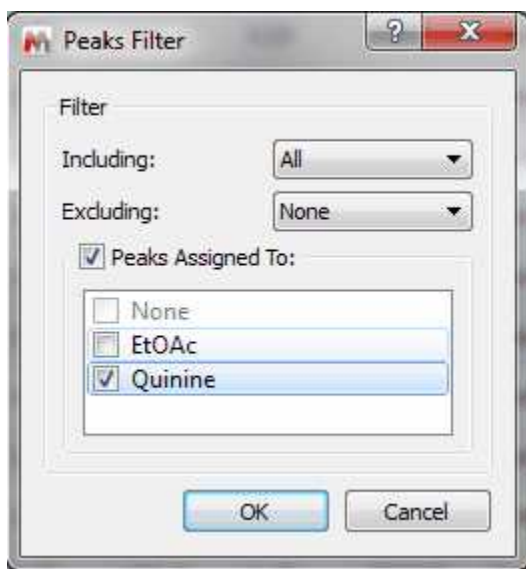

It will be also possible to synchronize the type of the peaks in the [table](#) (i.e: only Compounds peaks) with the peaks showed in the spectrum (by using the button 'Sync from Item') or viceversa, to synchronize the spectrum peaks with the peaks showed in the table ('Sync to Item' button).

9.3.1.1 Impurities Auto detection

This novel algorithm will be used to detect the solvents as impurities in your samples. Please bear in mind that this is the first version and will be improved in the oncoming versions of the software.

The first version of the algorithm will detect MeOH, EtOH, iPrOH and EtOAc in deuterated DMSO. Here you can see an example containing several solvents.

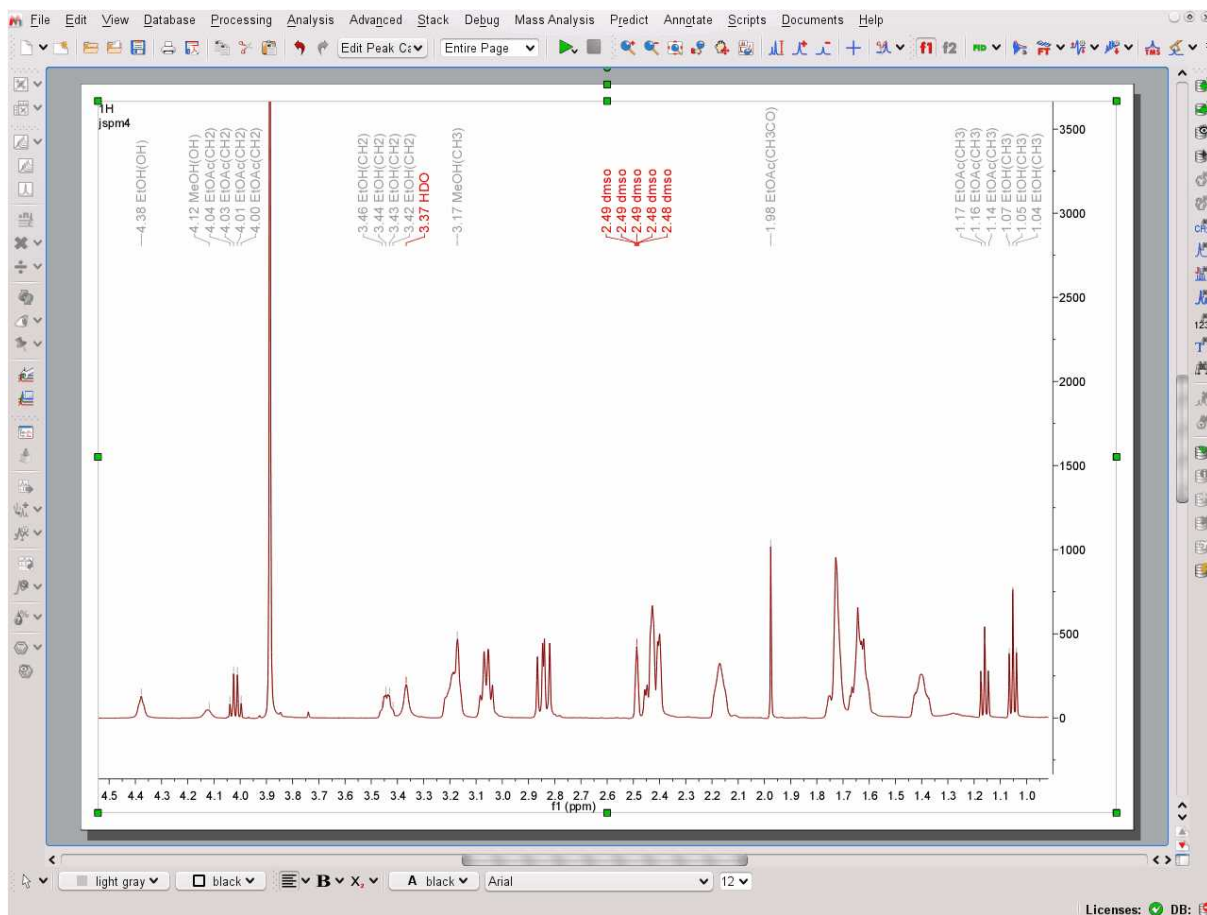

In the Peak Picking options, you will be able to select what solvents you want to be detected and you will be able to edit this table and to include additional solvents:

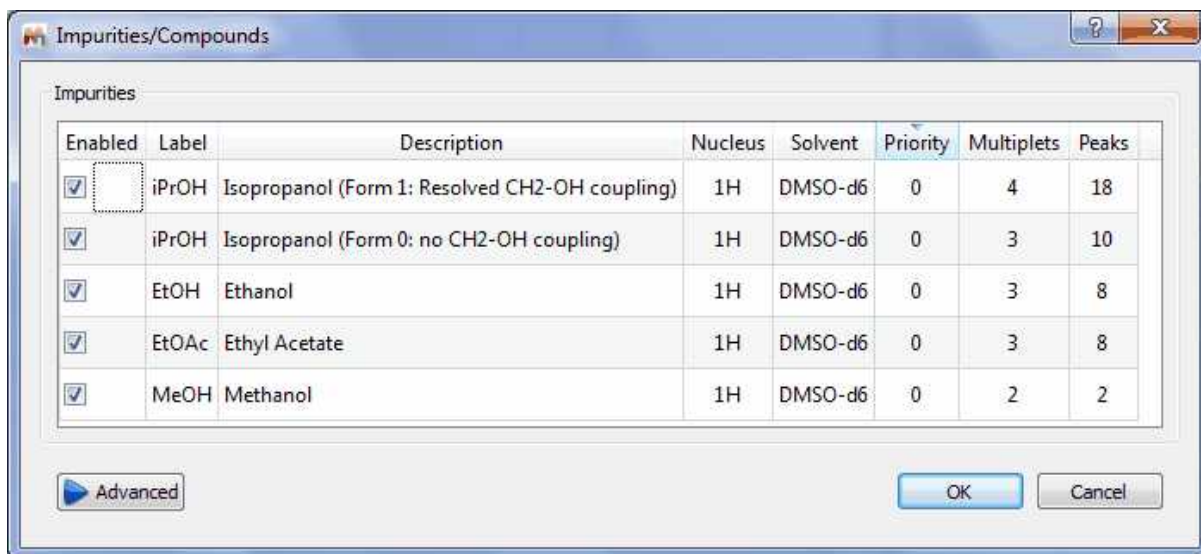

Clicking on the Advanced button, will allow you to add further impurities or to edit the existing ones:

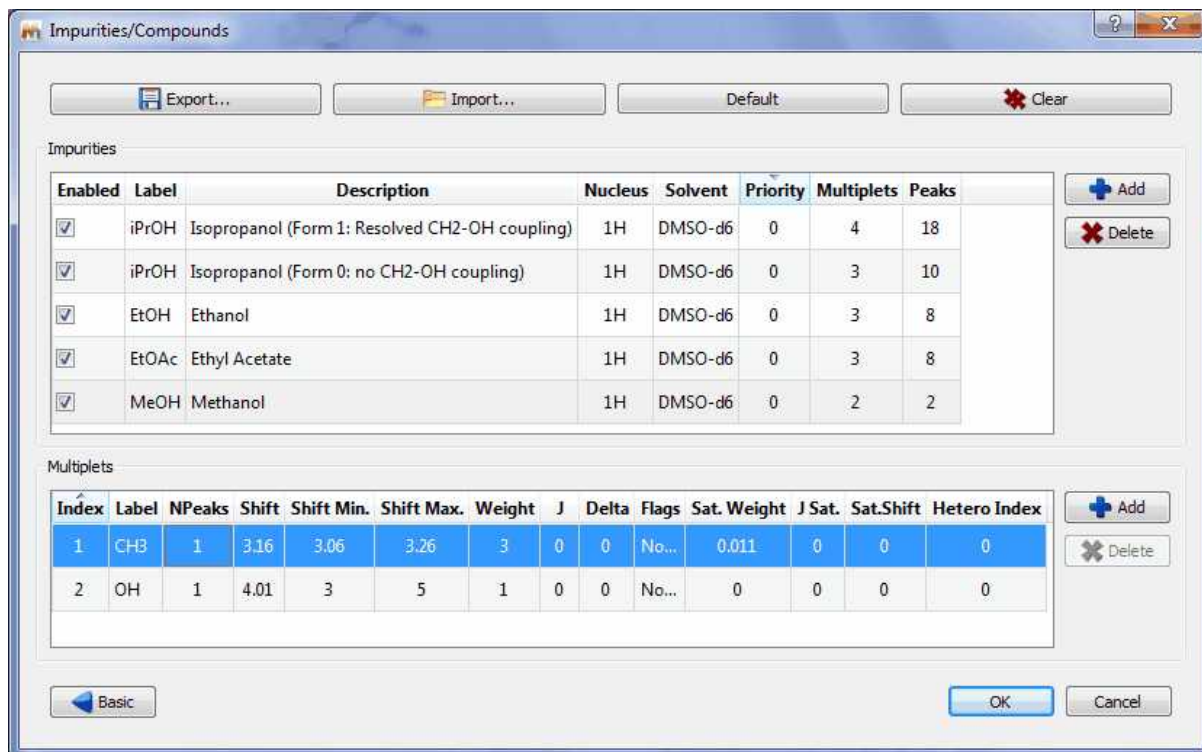

For example let's add CH3CN as a new solvent impurity. As CH3CN only has one multiplet visible in the 1H spectrum (the Me group), you can enter for the label CH3 and 1 for the number of peaks (Npeaks). For the base chemical shift, we have used a value of 2.08 and a minimum and maximum shift values of 2.04 and 2.10 respectively. This is the interval in which the CH3 resonance will be searched for.

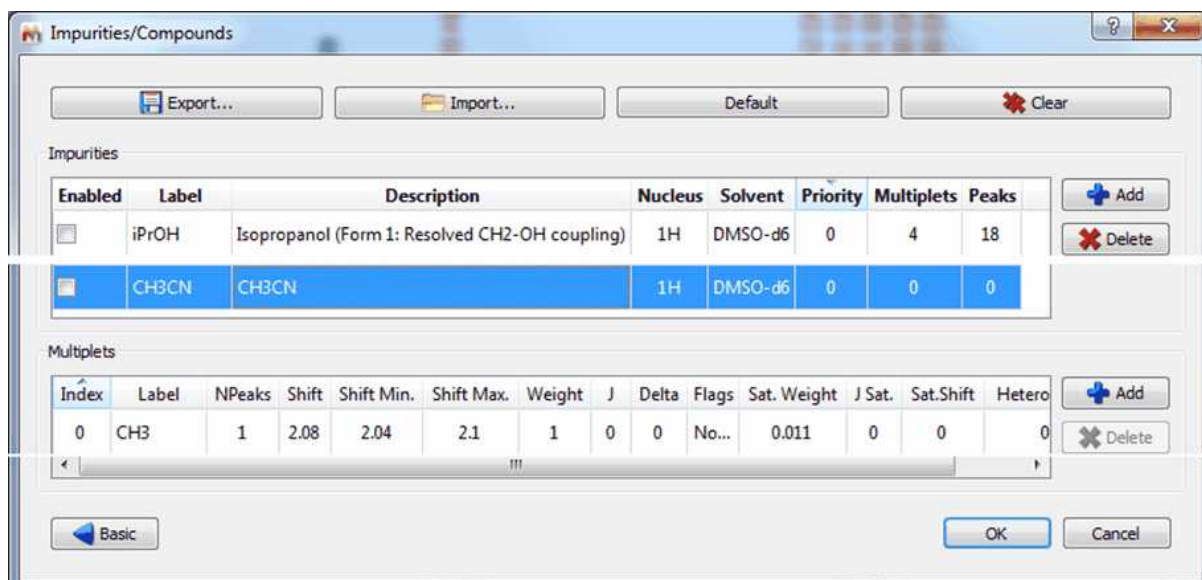

This is it! Now, when a Pick Picking with Auto Classify option enabled will be run, the CH3CN peak will be automatically detected, as illustrated in the spectrum below:

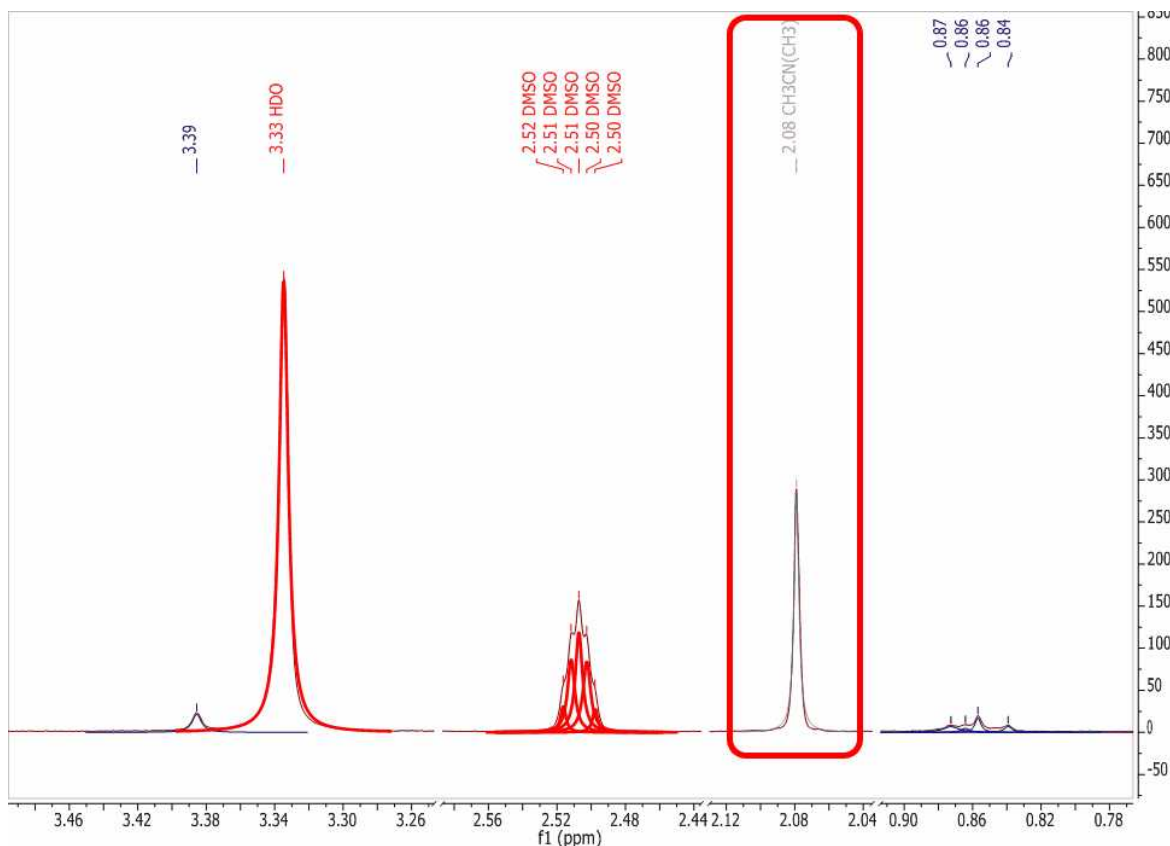

9.3.2 GSD (Global Spectral Deconvolution)

¹H NMR is for sure the most powerful technique for structure elucidation, especially for small organic molecules. Typically, an organic chemist uses the chemical shift, coupling constants and integration information contained in an ¹H-NMR spectrum to either verify or elucidate an unknown compound. Of course, it's quite common that a simple ¹H-NMR spectrum is not enough to unambiguously confirm a structure and thus other NMR experiments (e.g. ¹³C-NMR, HSQC, COSY, etc) are used to get more structural information.

Nevertheless, we have often found that many organic chemists do not always try to get the most out of ¹H-NMR spectra (which is the cheapest experiment), in particular when some multiplets are complex to interpret (due to the strong coupling) or when peaks overlap prevents valuable information to be detected in some multiplets.

As it is well known, there are two principal factors limiting the resolution power in a spectrum. First, we have the natural line width limitation imposed by the T₂ (spin-spin relaxation). For example, if T₂ is about 1 second, the peak linewidth at half height cannot be less than 0.32 Hz (remember, line width at half height = $1 / (\pi * T_2) = 1 / 3.1415 = 0.32$) no matter how powerful is our NMR instrument or the field homogeneity. On the other hand, there are instrumental shortcomings (e.g. spatial uniformity of the applied magnetic field, etc).

Nonetheless, there is an additional limiting factor, and whose importance is generally underestimated which has to do with the generally large number of transitions in ¹H-NMR spectra. In short, the peaks we can observe in a ¹H-NMR are just a small fraction of the actual transition resonances which are not observable because of the limited digital resolution. In fact, every peak in an ¹H-NMR spectrum is basically an envelope of a large number of transitions and its shape is dominated by the coupling pattern of the spin system. Even in molecules of modest size the number of distinct peaks is tens to

thousands times smaller than that of quantum transitions.

These problems have been the motivation of the development of a brand new peak analysis algorithm, the so-called GSD (Global Spectral Deconvolution); which applies automatically a deconvolution of the whole spectrum in a few seconds and does not require that the user set a starting point for the fitting of each multiplet.

Let's see the GSD in action. Just open a 1H-NMR spectrum:

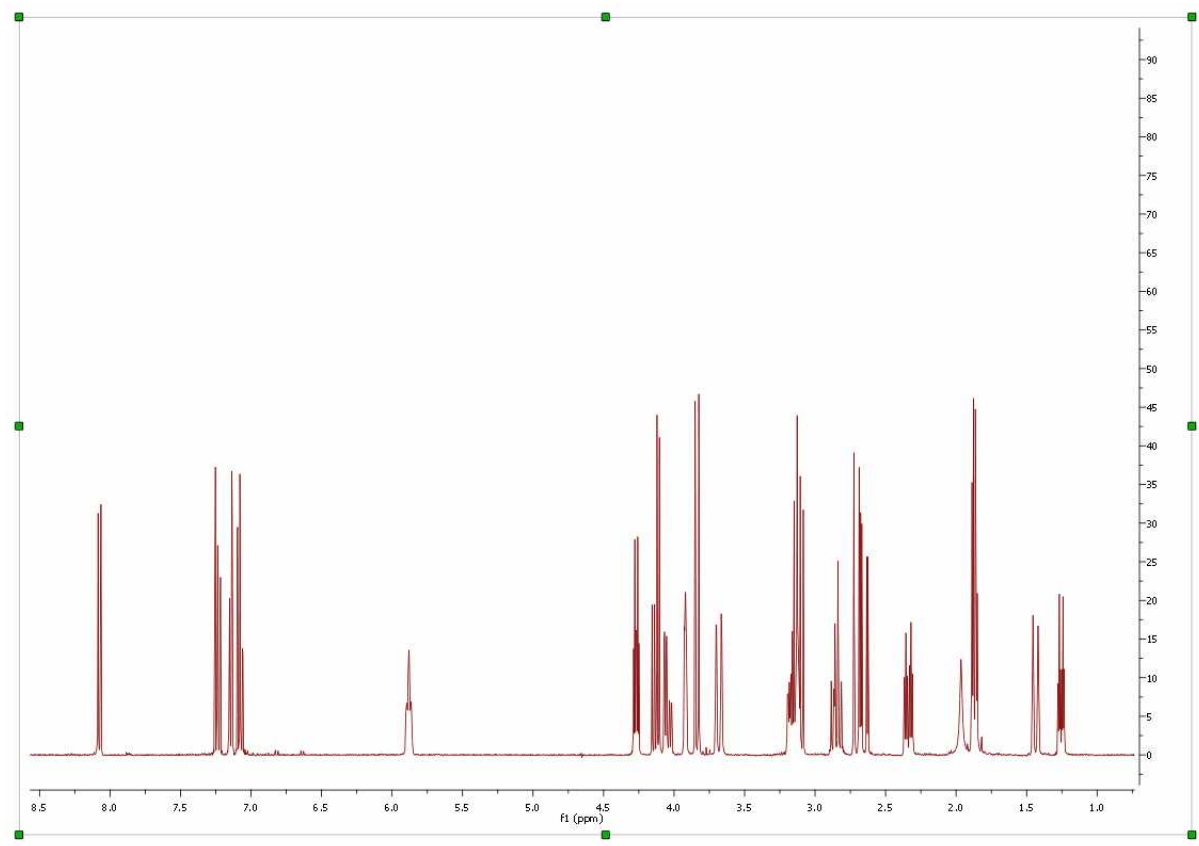

Select GSD as the Peak Picking method (in the Peak Picking Options) and apply a Peak Picking which will carry out the deconvolution of the whole spectrum. **See also:** ["Using GSD for multiplets analysis"](#)



Automatic multiplet deconvolution will be applied to the whole spectrum without asking the user to select multiplets, specify number of lines and their approximate locations, etc ... **Everything is automatic!** (Ideally, data would be zero filled to 64K points and line broadening functions would not be used.).

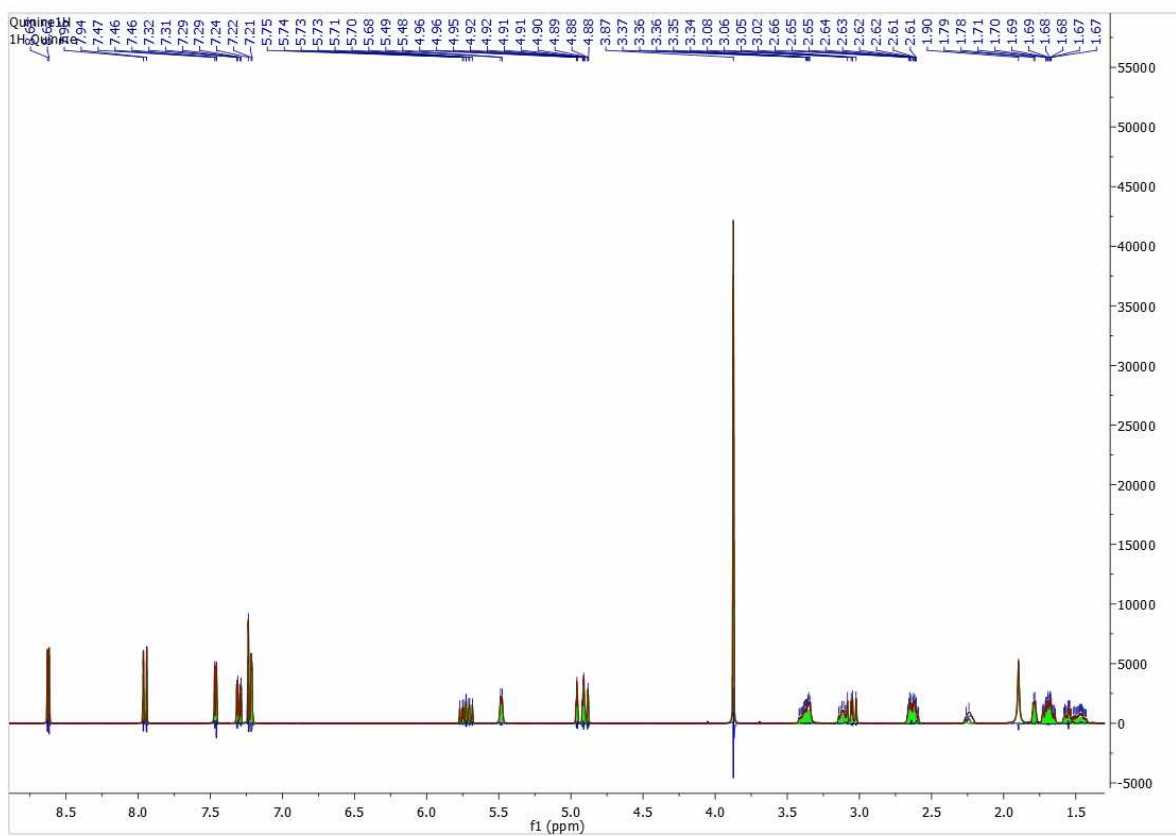

Let's expand an area to see how the algorithm works:

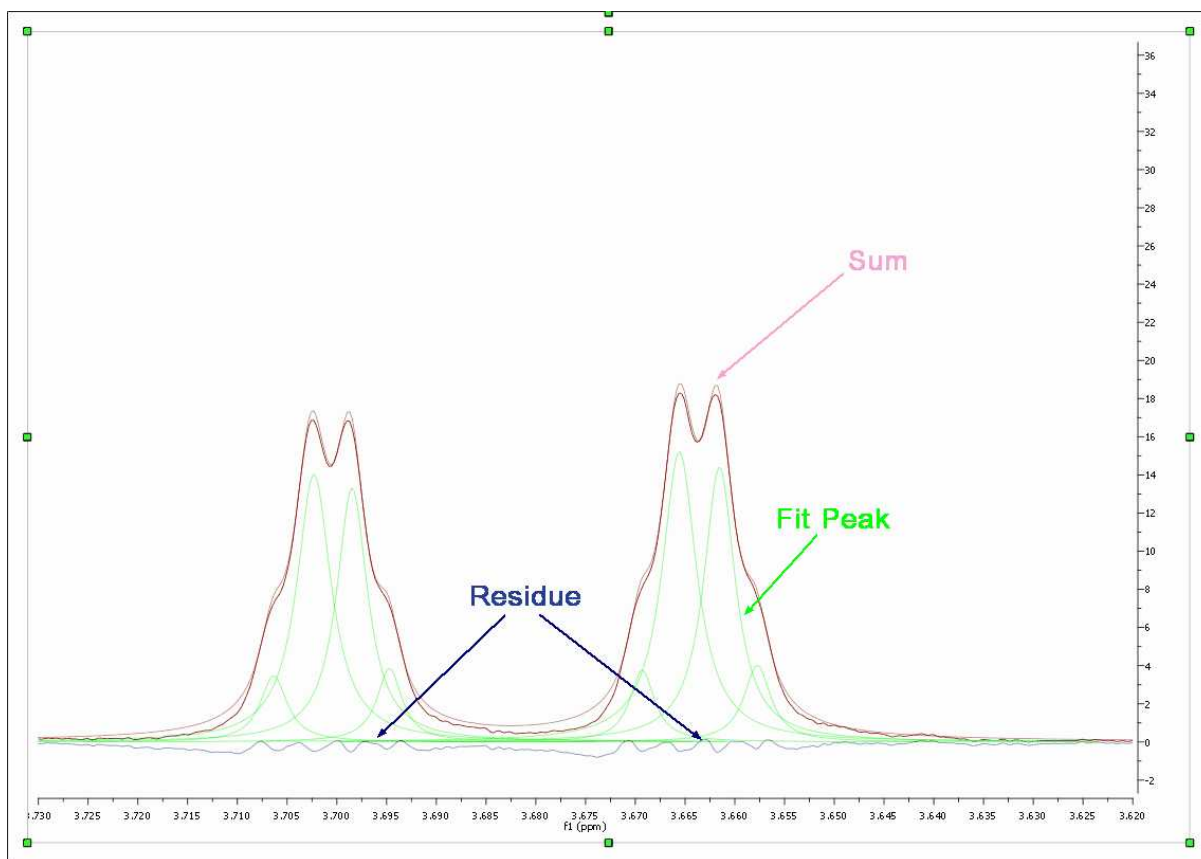

As you can see in the picture above you will obtain a green line to show the fit peaks, a blue line to show the residue and red line to show the sum.

It's very important to realize that the result of GSD is just a list of peaks, but each peak is fully characterized (chemical shift, Peak Width, Height, Phase, Area, etc). It is possible to see the list of the GSD peaks just by following the menu 'View/Tables/Peaks' (or by right clicking on any toolbar and selecting 'Tables/Peaks'):

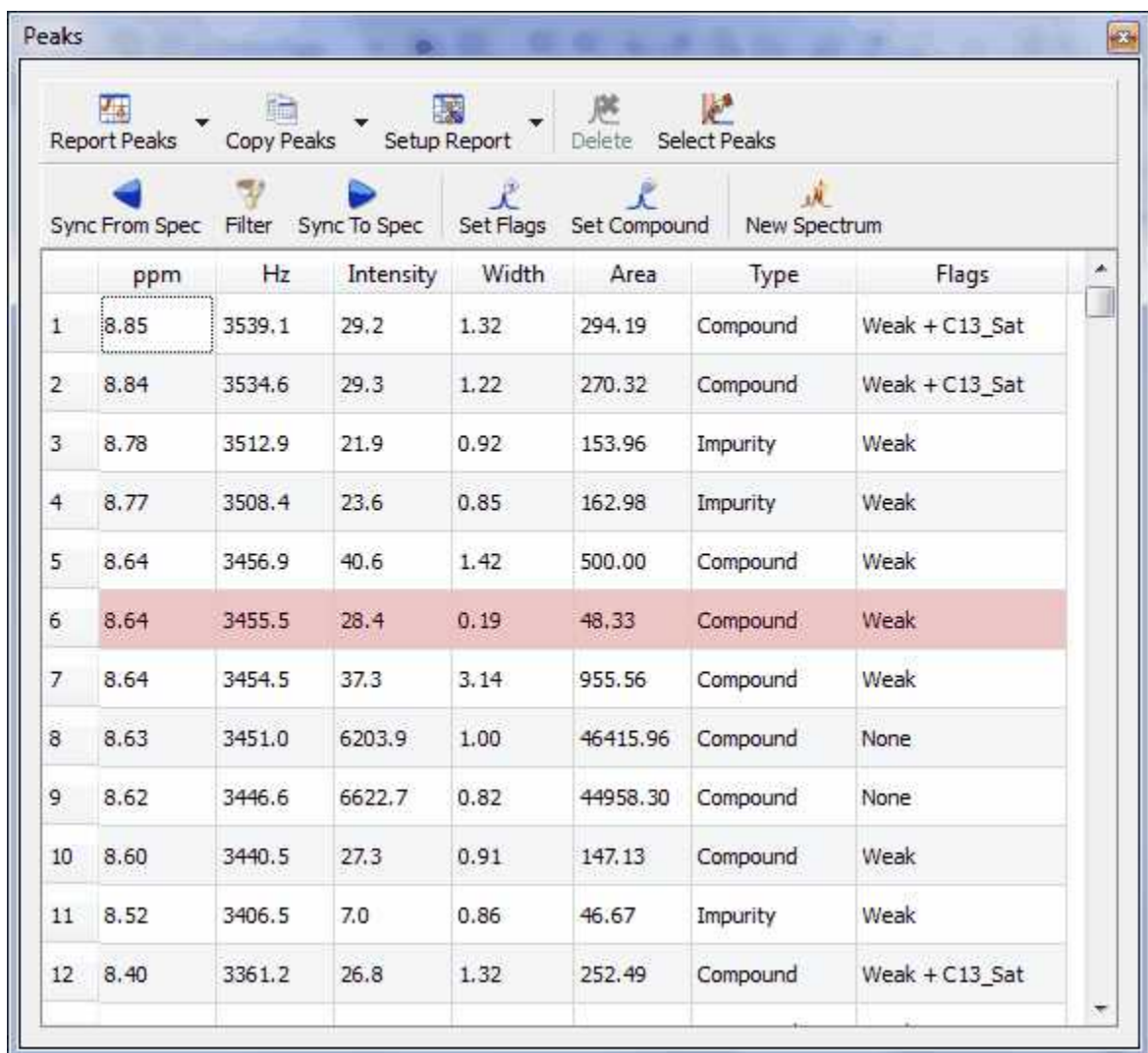

	ppm	Hz	Intensity	Width	Area	Type	Flags
1	8.85	3539.1	29.2	1.32	294.19	Compound	Weak + C13_Sat
2	8.84	3534.6	29.3	1.22	270.32	Compound	Weak + C13_Sat
3	8.78	3512.9	21.9	0.92	153.96	Impurity	Weak
4	8.77	3508.4	23.6	0.85	162.98	Impurity	Weak
5	8.64	3456.9	40.6	1.42	500.00	Compound	Weak
6	8.64	3455.5	28.4	0.19	48.33	Compound	Weak
7	8.64	3454.5	37.3	3.14	955.56	Compound	Weak
8	8.63	3451.0	6203.9	1.00	46415.96	Compound	None
9	8.62	3446.6	6622.7	0.82	44958.30	Compound	None
10	8.60	3440.5	27.3	0.91	147.13	Compound	Weak
11	8.52	3406.5	7.0	0.86	46.67	Impurity	Weak
12	8.40	3361.2	26.8	1.32	252.49	Compound	Weak + C13_Sat

This table contains information about the chemical shift, width, height, Area, Type and Flags. It is possible to edit automatically the Type and Flags of each signal, just by selecting 'Auto Classify Peaks' in the Peak Picking scroll down menu:

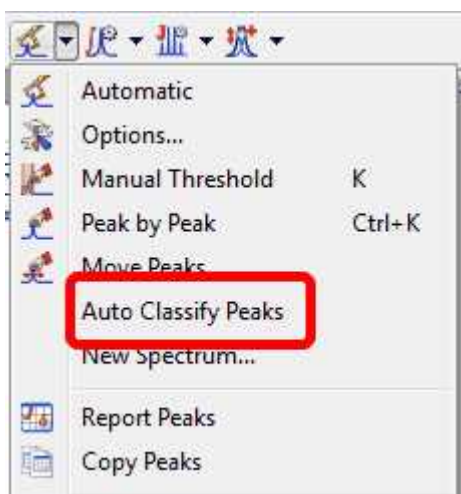

It is possible to export the GSD peaks as ASCII just by following the menu 'Scripts/Export ASCII/GSD Spectra'.



Please bear in mind that the 'Auto Classify Peaks' feature incorporates a '**Solvent Detection**' tool which is an **Expert System** that exploits the resolution enhancement power of GSD and applies a scoring system which analyses multiplet patterns, ^{13}C satellites, line widths and chemical shifts to decide whether a given line corresponds with a solvent resonance.

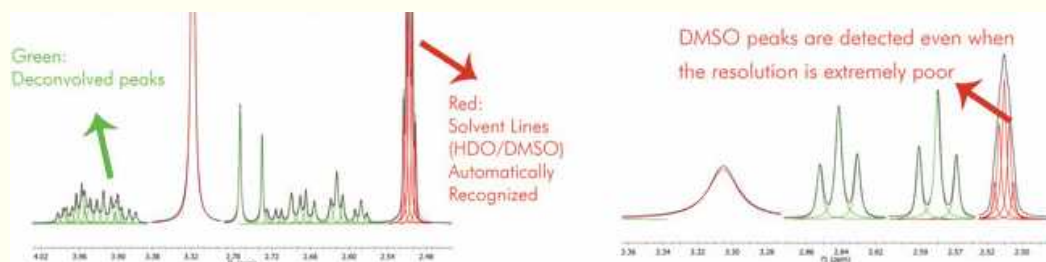

It is also possible to manually edit the 'Type' and the 'Flags' table just by double click on the applicable cell or by clicking on the '**Set Flags**' button. To change the flag to several peaks at the same time just hold down the Ctrl key and click.

	ppm	Hz	Intensity	Width	Area	Type	Flags
1	8.85	3539.1	29.2	1.32	294.19	Compound	Weak + C13_Sat
2	8.84	3534.6	29.3	1.22	270.32	Compound	Weak + C13_Sat
3	8.78	3512.9	21.9	0.92	153.96	Impurity	Weak
4	8.77	3508.4	23.6	0.85	162.98	Solvent	Weak
5	8.64	3456.9	40.6	1.42	500.00	CS Reference	Weak
6	8.64	3455.5	28.4	0.19	48.33	Quant...rence	Weak

Once you have edited your GSD spectrum, you can generate a new spectrum with the fit peaks, just by selecting 'New Spectrum' in the Peak Picking scroll down menu:

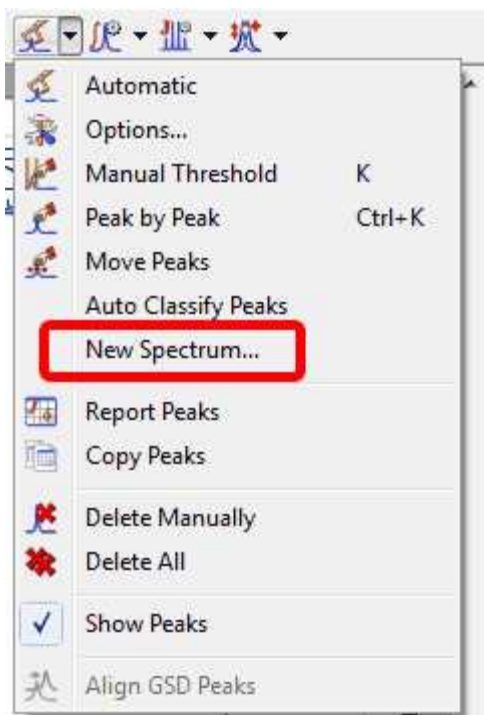

This will display a dialog box from where you will be able to select the mode of the new spectrum (Synthetic, Sticks, Uniform Line Width or Proportional Line Width). From here you can also exclude the peaks with a specific 'Type or Flag' and you can get the spectrum a new item or stacked with the original one.

We will generate a new spectrum with a proportional Line Width of 0.3, including only the peaks marked as compound (without artifacts, solvents, impurities, etc.)

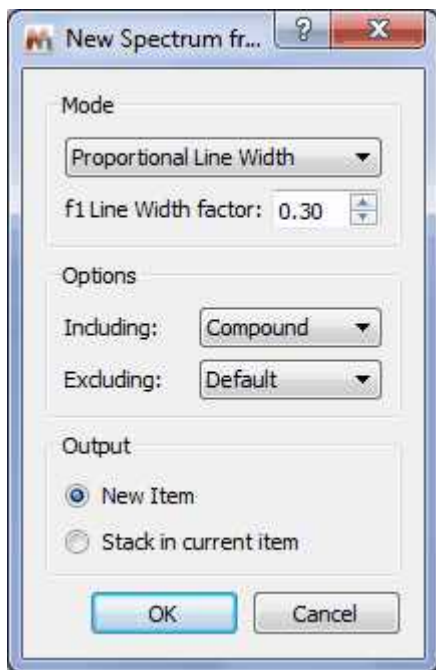

Here is the result of the New spectrum from GSD:

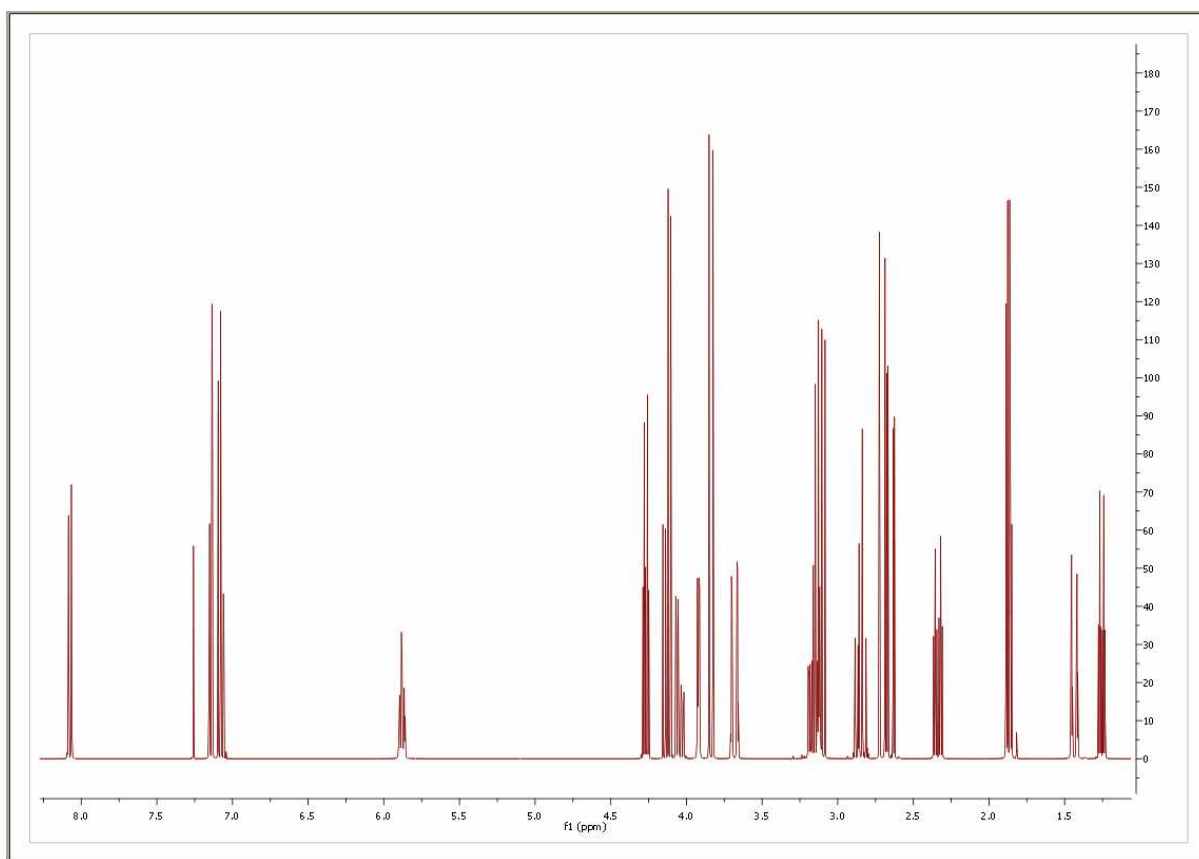

You will see in the picture below an expanded region of the original spectrum and the GSD one in stacked one. As you can see, now it is possible to measure the coupling constants more accurately, as only the compound peaks are displayed and they are displayed at an artificially increased higher resolution

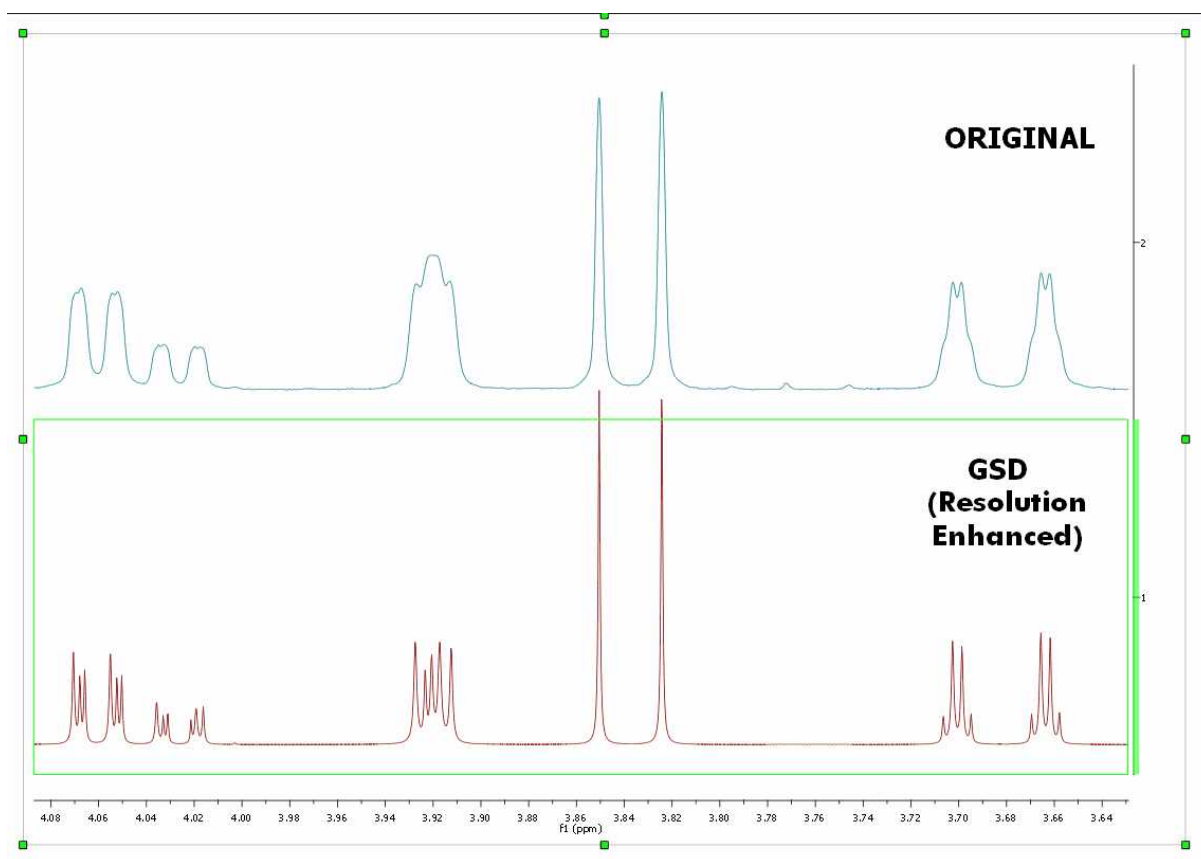

Improving GSD with [Line Fitting](#)

After the GSD peak picking, allow the user to define a line fitting region, and it uses all the GSD-peaks in that region as the starting peaks. The user changes the peaks and then re-fit the peaks as usual. Once satisfied, the user clicks a button in the Line Fitting panel to update the GSD peaks table, or to discard the current results. It appears that we have everything except the last part – to update the Line Fitting results to the GSD peaks table.

9.3.2.1 What else can I do with GSD?

What else can I do with GSD?

As you have seen above, from the GSD list of peaks you could create a mocked spectrum with enhanced resolution; but in addition you can use GSD for example to **remove solvent lines**. Consider the following spectrum containing solvent peaks (DMSO/Water):

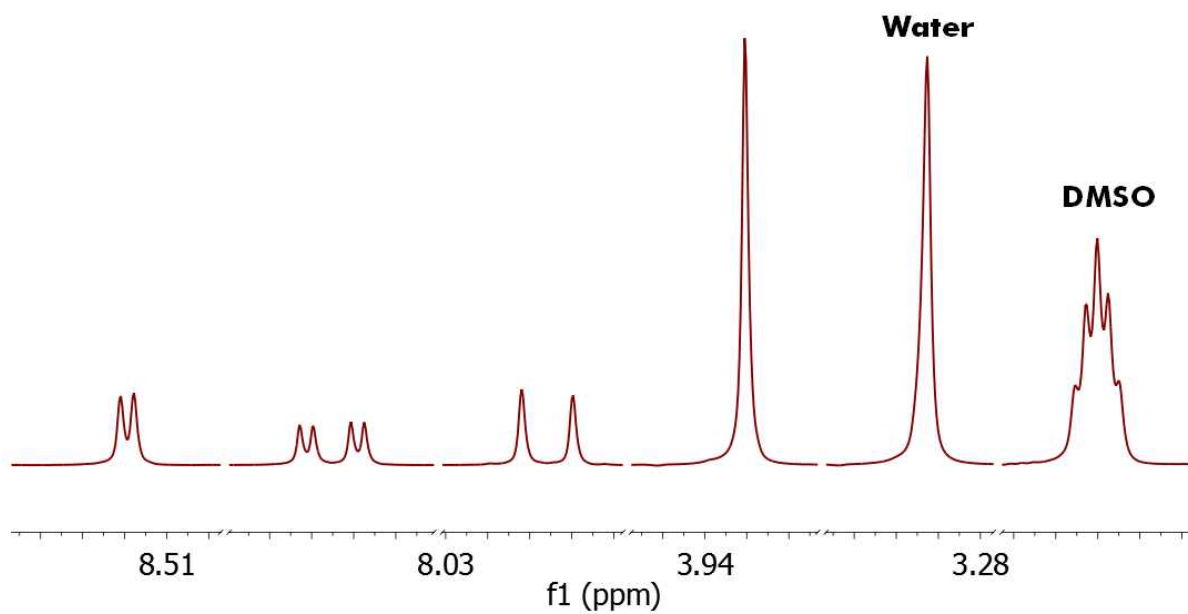

To remove the undesired peaks, just run a Peak Picking with GSD and with the 'Auto Classify Peaks' option enabled, in order to autodetect the solvent peaks (in yellow in the figure below):

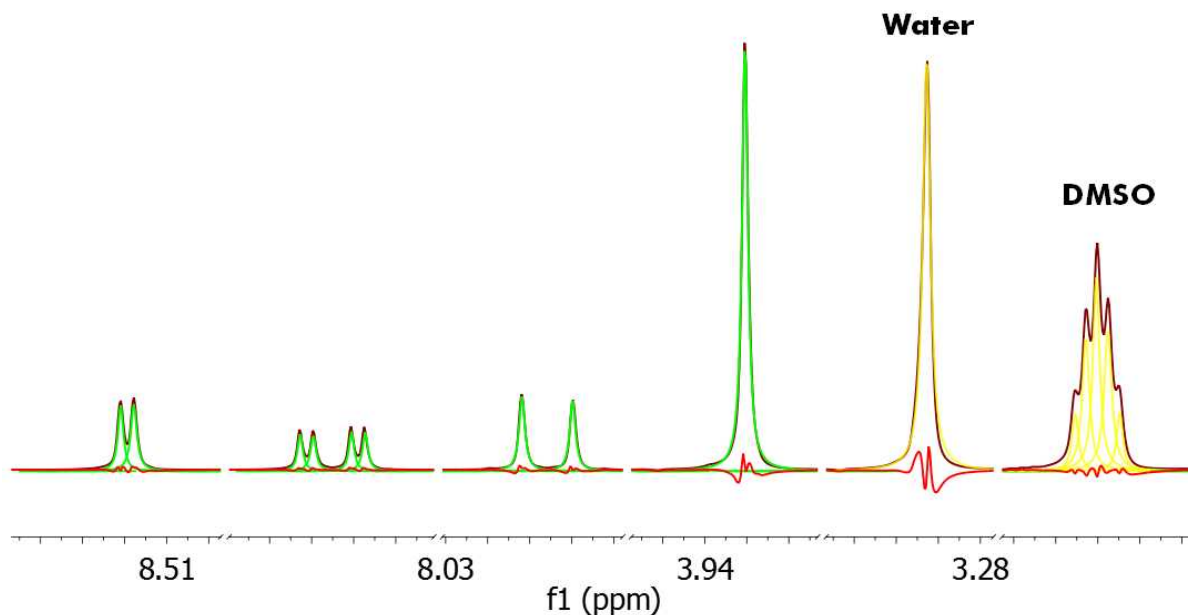

And finally we create a new synthetic spectrum **without** the solvent lines:

GSD synthetic spectrum – Solvent free

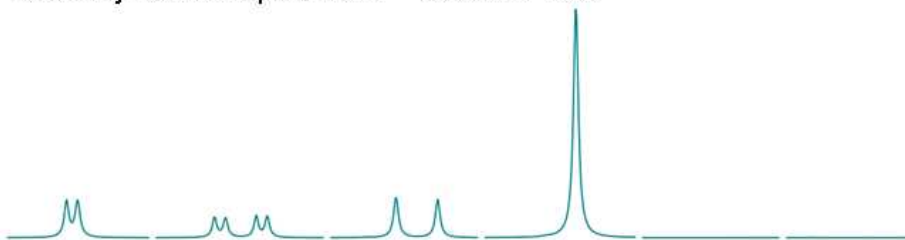

Original experimental spectrum

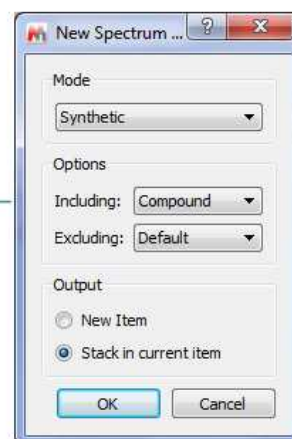
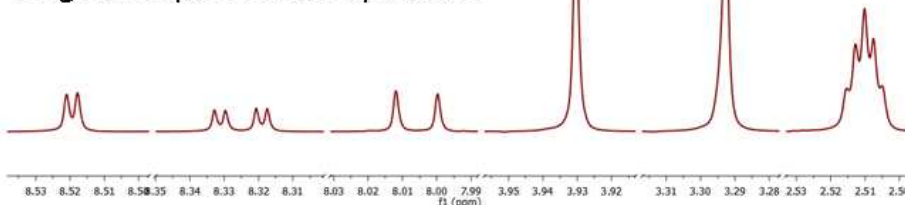

Here you can see another example where the solvent and compound signals are overlapped. Mnova's autoedit successfully separates a triplet signal sitting on the HDO signal. The approach of generating dark regions used by other software products would miss the triplet at 3.5 ppm and therefore any verification efforts would fail.

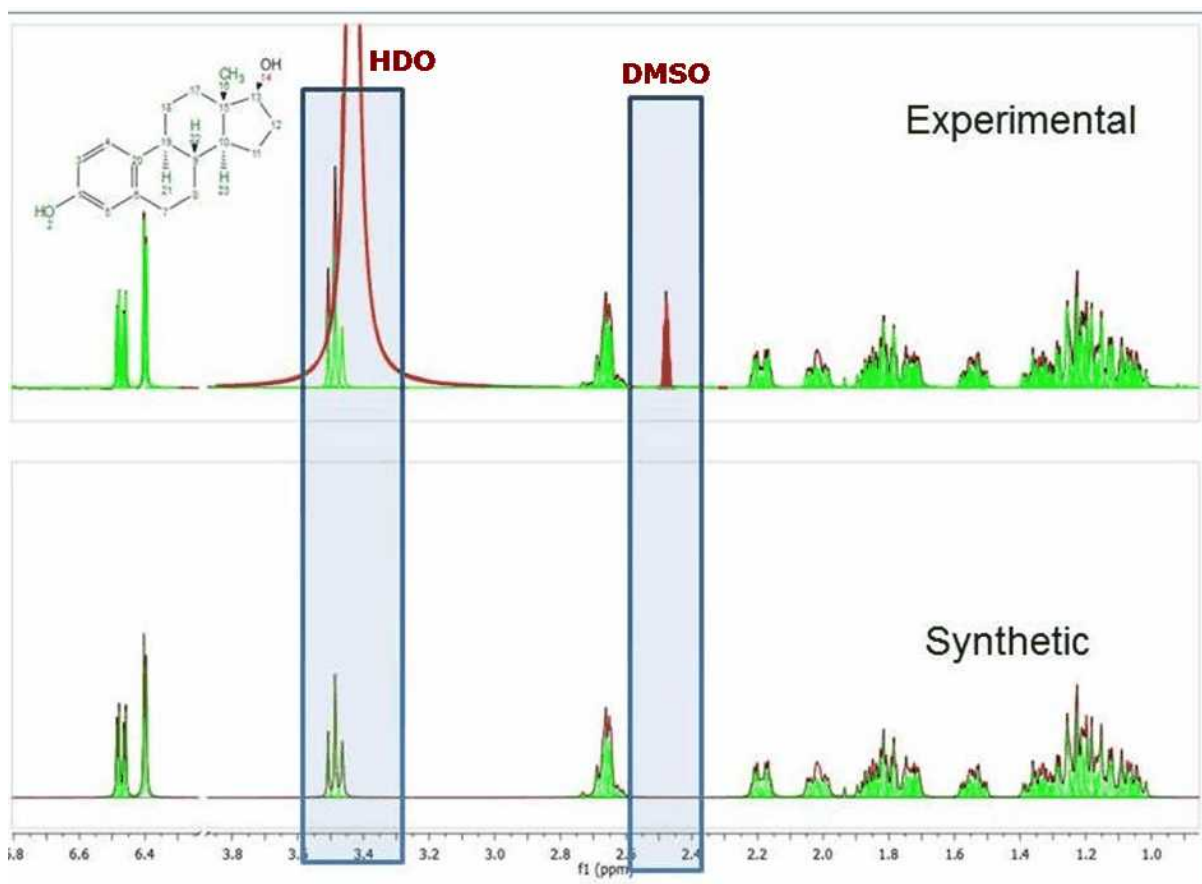

9.3.3 Peaks Table and Reports

Peak Table: The user will obtain the peak table by following the menu 'View/Tables/Peaks'. Clicking on any peak of the spectrum will automatically scroll up/down the table to the position of currently highlighted peak in the spectrum,

Please note that **hovering** the mouse over the peak label will **highlight** the applicable **peak** shape in the spectrum. The same effect you will obtain if you hover the applicable cell in the Peaks Table. Double clicking on a row in Peaks table will **zoom in** that peak in the spectrum. It will be possible to move the peaks labels up and down just by clicking and dragging.

Peaks

Report Peaks Copy Peaks Setup Report Delete Select Peaks

Sync From Spec Filter Sync To Spec Set Flags Set Compound New Spectrum

	ppm	Hz	Intensity	Width	Area	Type	Flags
1	8.85	3539.1	29.2	1.32	294.19	Compound	Weak + C13_Sat
2	8.84	3534.6	29.3	1.22	270.32	Compound	Weak + C13_Sat
3	8.78	3512.9	21.9	0.92	153.96	Impurity	Weak
4	8.77	3508.4	23.6	0.85	162.98	Impurity	Weak
5	8.64	3456.9	40.6	1.42	500.00	Compound	Weak
6	8.64	3455.5	28.4	0.19	48.33	Compound	Weak
7	8.64	3454.5	37.3	3.14	955.56	Compound	Weak
8	8.63	3451.0	6203.9	1.00	46415.96	Compound	None
9	8.62	3446.6	6622.7	0.82	44958.30	Compound	None
10	8.60	3440.5	27.3	0.91	147.13	Compound	Weak
11	8.52	3406.5	7.0	0.86	46.67	Impurity	Weak
12	8.40	3361.2	26.8	1.32	252.49	Compound	Weak + C13_Sat

The Peaks table displays the list of peaks, including the following information: chemical shift in ppm and Hz, Intensity (height), Width (in Hz, at half maximum of the peak), Type (compound, solvent, impurity, etc), Flags, Multiplicity (for the carbons) and 'Annotations'.

The user can report the Peak table directly on the spectrum by clicking on the **'Report Table'** icon under the 'Report Text' scroll down menu. To delete an undesired peak, click on the **'Delete'** icon of the Peak List, or select 'Delete Manually' on the Peak Picking scroll bar icon:

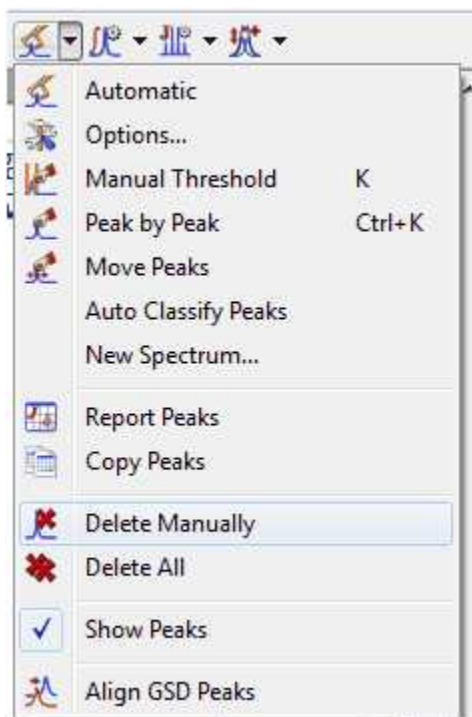

By default, peak frequencies are listed directly on the spectrum but they can also be accessed via the *Peak Picking table* and also as a **'Peak List'** by clicking on the **'Report Peaks'** icon. The user will be able to select the 'Peak Report' Template between several journal formats by selecting 'Setup Report' in the 'Peaks table'.

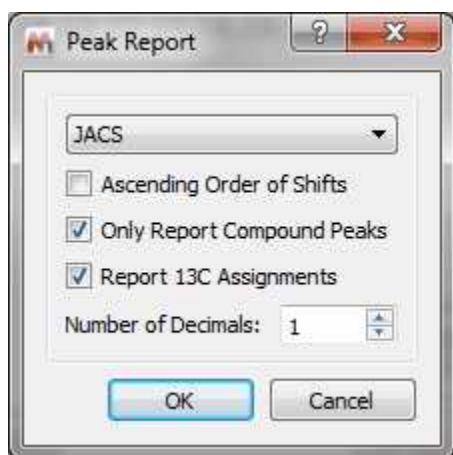

From here you can select the order of the report (ascending or descending), the option to only report the compounds peaks, to report the 13C assignment and to select the number of decimals.

The user will be able to copy the **'Peak List'** report to the clipboard by selecting 'Copy Peaks' on the 'Peaks Table'.

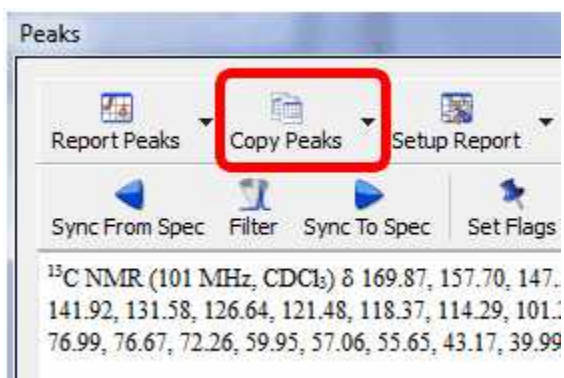

The peak list can also be exported as an ASCII file by following the menu 'File/Save as' and selecting 'MestReNova Peaks (*.txt)':

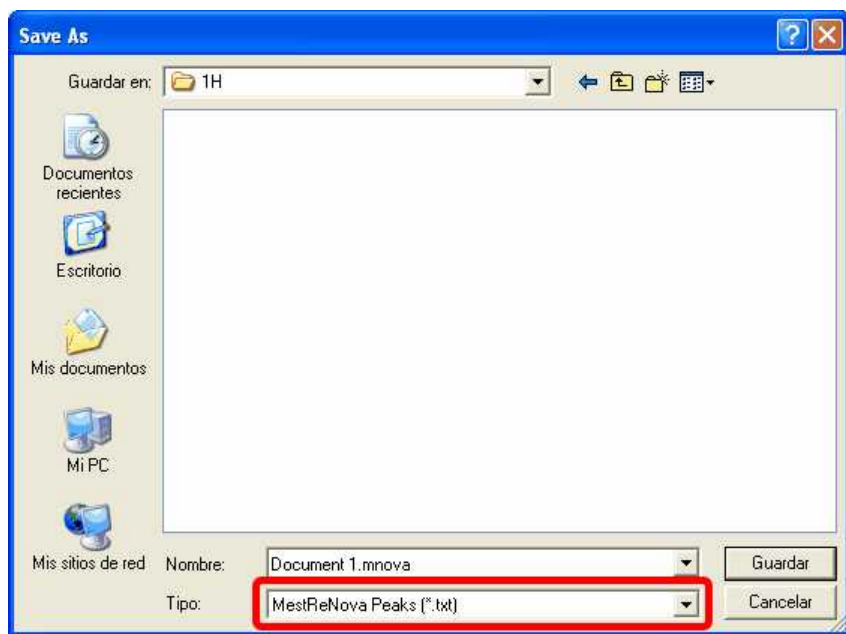

It is also possible to copy&paste the peaks from one spectrum to another, just by pressing 'Ctrl+C' in the original spectrum and then following the menu 'Edit/Paste Properties/Paste NMR Peaks in the other spectrum (or spectra, if you have previously selected them in the page navigator):

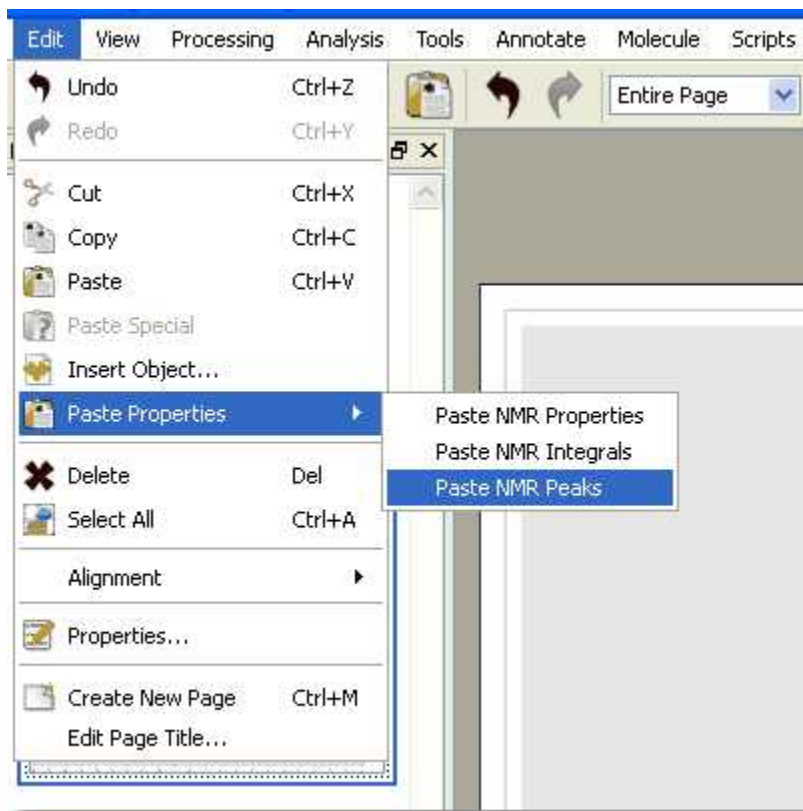

If your document contains more than one compounds, you will be able to select the compound for each peak from the Peaks Table (by clicking on the 'Set Compound' button or by double clicking on the 'Impurity/Compound' cell). The same effect will be obtained by right clicking on the Peak label and selecting 'Set Peak Compound':

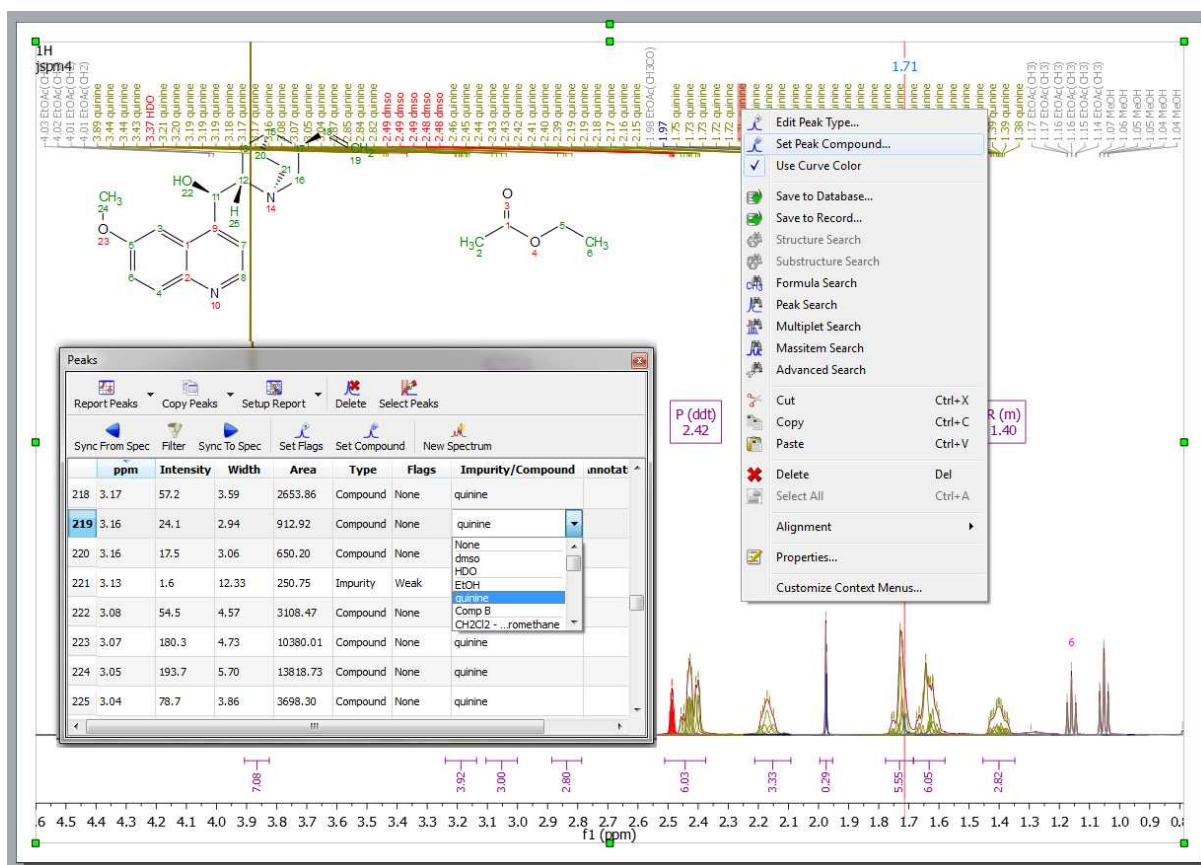

From the Peaks table it will be possible to apply some filter (by clicking on the applicable button) to show for example only Compounds Peaks. If the spectrum contains peaks belonging to more than one compound, we can show only the peaks assigned to one of them (by using the 'Filter' button):

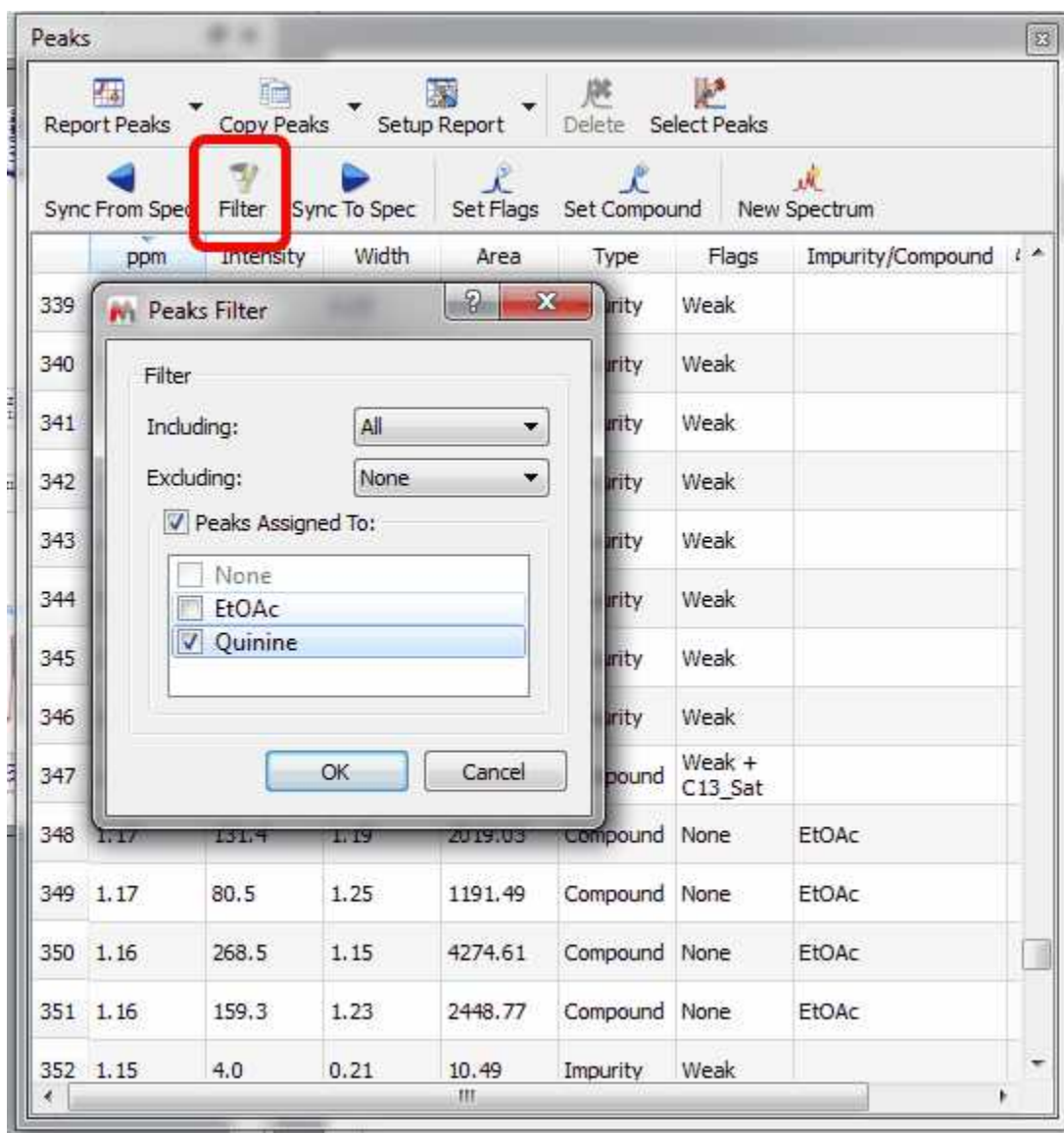

It will be also possible to synchronize the type of the peaks in the table (i.e: only Compounds peaks) with the peaks showed in the spectrum (by using the button 'Sync from Item') or viceversa, to synchronize the spectrum peaks with the peaks showed in the table ('Sync to Item' button).



The 'New spectrum' button will generate a synthetic spectrum from the selected peaks in the table or for all the peaks shown in the table if there is no selection. Here you can see an example, showing a mixture of two compounds on top and the synthetic spectra (generated with the 'New Spectrum' feature) of each compound at the bottom:

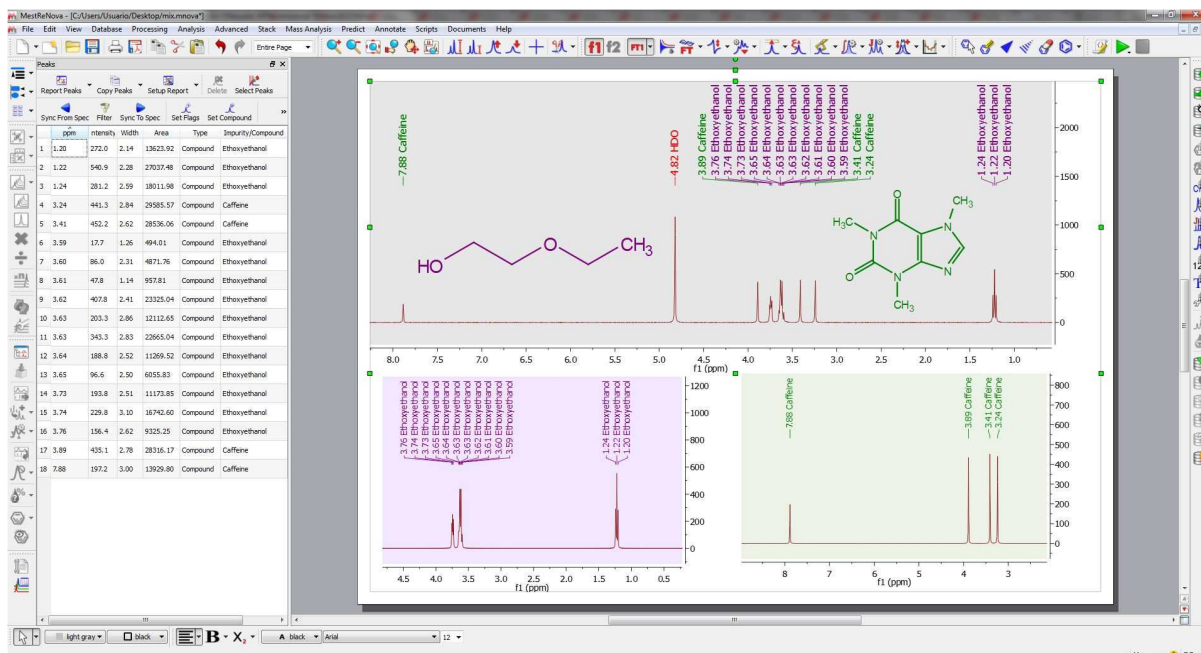

It is possible to edit automatically the Type and Flags of each signal, just by selecting 'Auto Classify Peaks' in the Peak Picking scroll down menu:

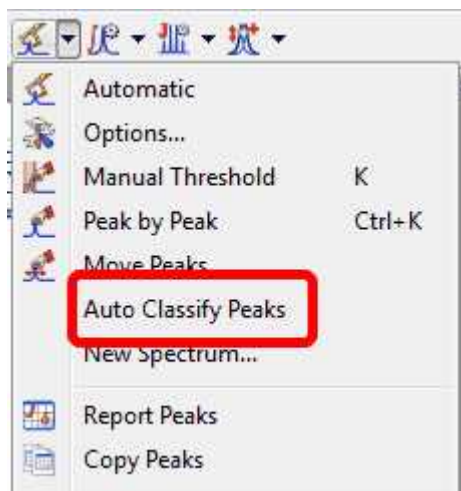

It is also possible to manually edit the 'Type' and the 'Flags' table just by double click on the applicable cell:

	ppm	Hz	Intensity	Width	Area	Type	Flags
1	8.85	3539.1	29.2	1.32	294.19	Compound	Weak + C13_Sat
2	8.84	3534.6	29.3	1.22	270.32	Compound	Weak + C13_Sat
3	8.78	3512.9	21.9	0.92	153.96	Impurity	Weak
4	8.77	3508.4	23.6	0.85	162.98	CS Reference	Weak
5	8.64	3456.9	40.6	1.42	500.00	Compound	Weak
6	8.64	3455.5	28.4	0.19	48.33	Compound	Weak

You can also select several cells and click on the 'Set Flags' button to change the Type or the Flags of several peaks at the same time:

	ppm	Hz	Intensity	Width	Area	Type	Flags
1	8.63	3451.0	5611.9	1.15	52127.17	Compound	None
2	8.62	3446.5	5678.3	1.13	51807.32	Compound	None
3	7.96	3185.3					
4	7.94	3176.1					
5	7.47	2987.5					
6	7.46	2982.9					
7	7.22	2926.9					

It is possible to change the Peak type just by right clicking on any peak and selecting 'Edit Peak Type':

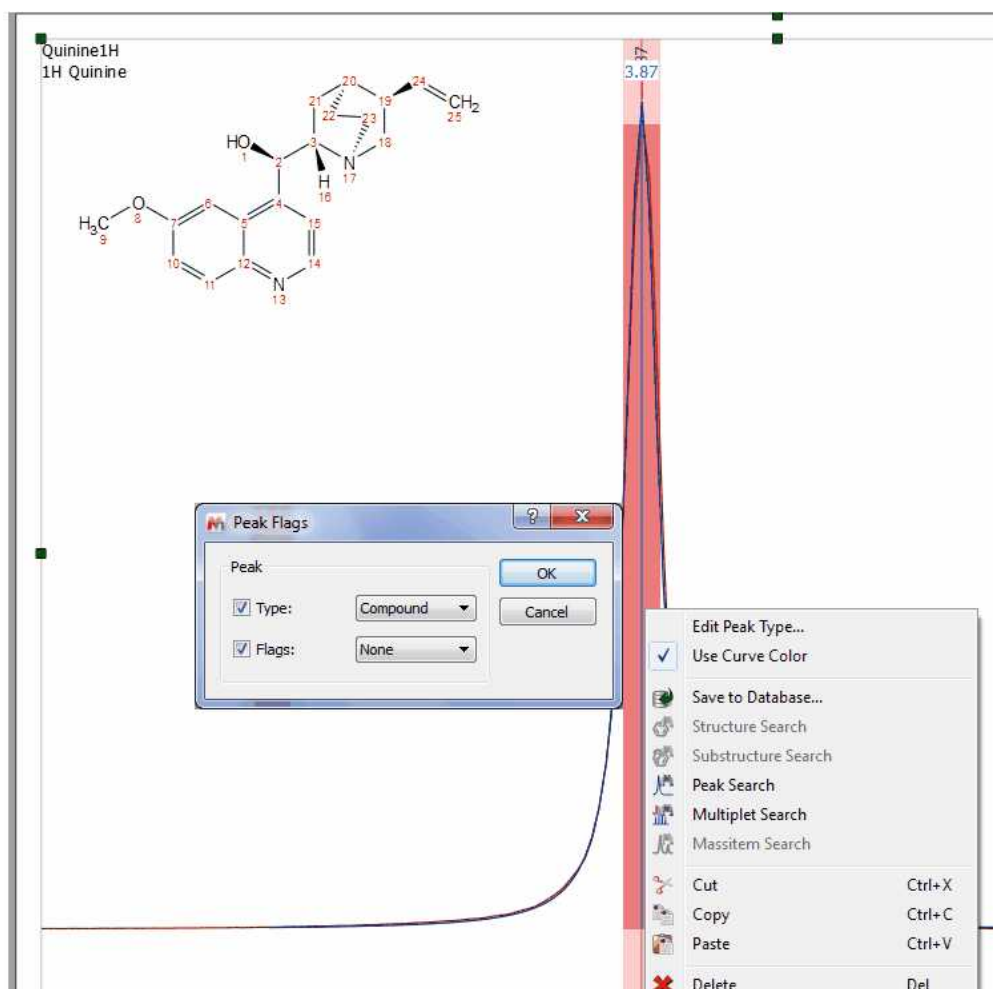

The user will be able to highlight in the table any desired peak just by clicking on the 'Select Peaks' button and then selecting the peaks in the spectrum (by clicking and dragging). Those peaks will be highlighted in the table and the user will be able to modified their flags (or Type) by clicking on the 'Set Flags' button. In the example below, we have changed the type of two peaks (from compound to impurity):

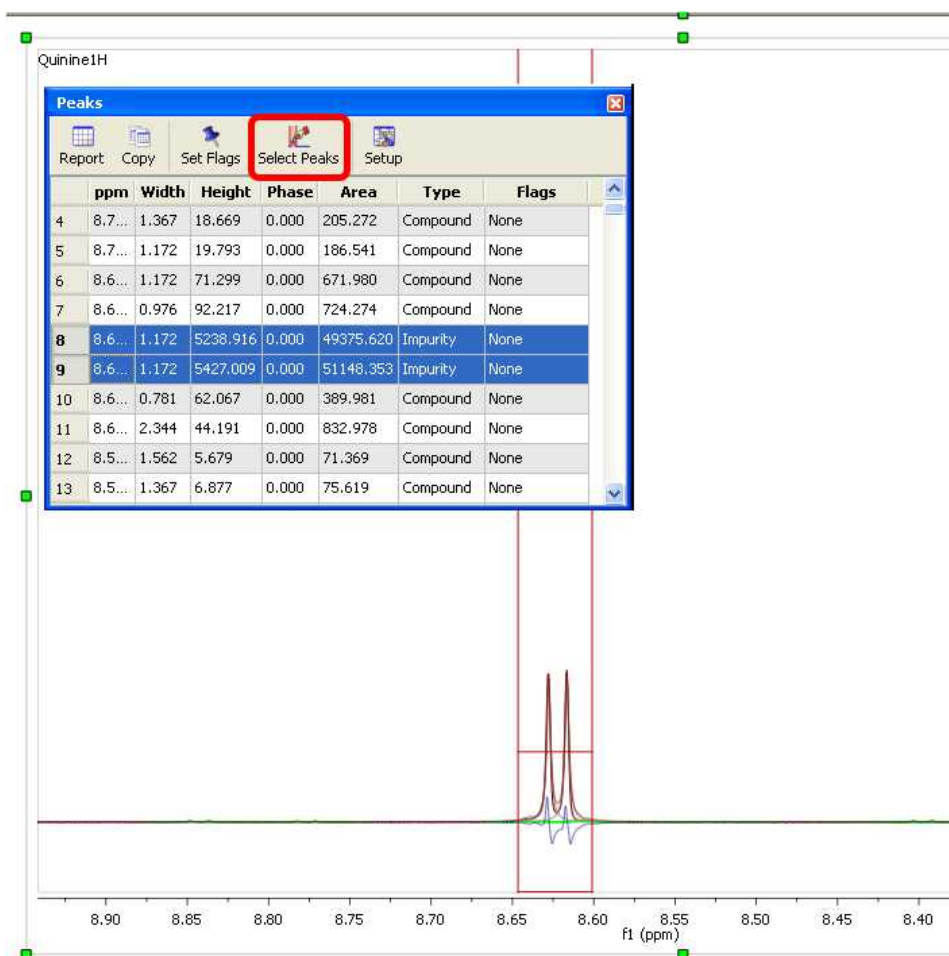

You can customize the appearance of the table by clicking on the 'Setup' button:

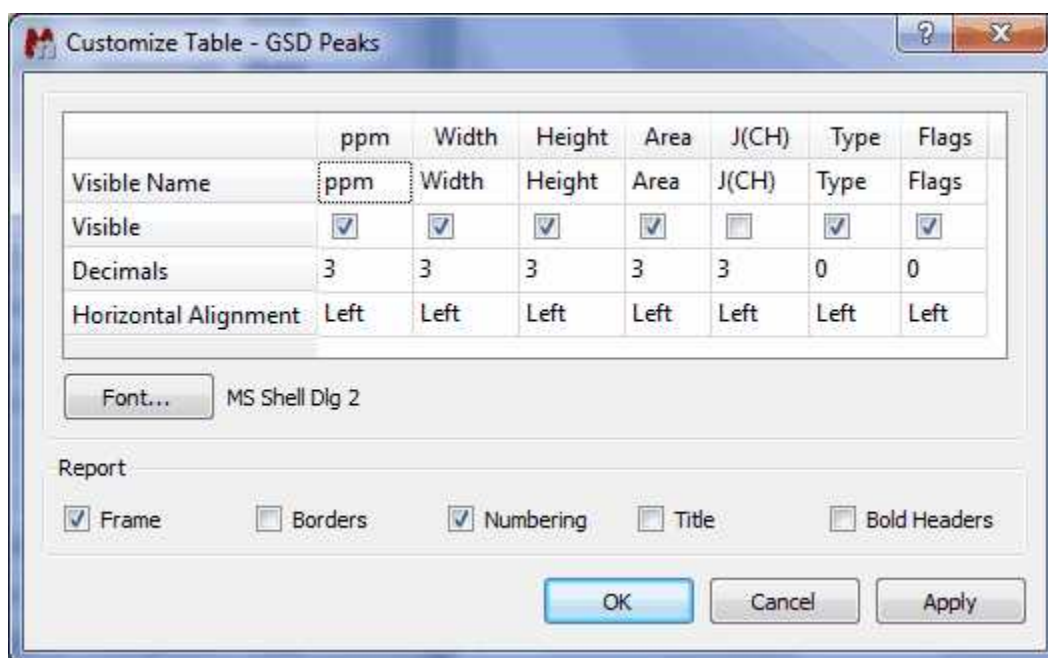

See also [Tables](#).

Customizing Peak Reports

It will be also possible to add additional report templates by creating new scripts. You will find an example of a script (customPeakReporter.qs) with a different 'Peak Report Template' in the 'examples/scripts' folder of Mnova. To see how to customize this script, take a look at the '[Multiplet Analysis](#)' chapter. The concept will be the same.

```

Edit Script
Filename: customPeakReporter.gs

Script

/* This creates a Custom Peak Reporter */
function MyPeakReporter()
{
    PeakReporter.call(this);

    var setts=new Settings(Application.mainWindow.scriptHandler.settings);
    this.customMessage = setts.value( MyPeakReporterSettingsKey, "My Peak Reporter" );

    this.name = new String("My Peak Reporter");

    // Define font size and font family
    this.font = "<font style='font-size: 10pt; font-family: Times New Roman'>";

    this.nucleusTemplate="%1";
    // Report header. %1 will be replaced with nucleusString, %2 with frequency, %3 with solvent
    //this.header = "My Peak Reporter %1 NMR (%2 MHz, %3) &delta; ";
    this.header = this.customMessage+" %1 NMR (%2 MHz, %3) &delta; ";
    //Report f1 value in 2D spectrum
    this.reportf1In2D=false;
    //Peak templates:
    this.peakTemplate="%1"; // %1 - delta
    this.peakTemplate2D="( %2 %1)"; // %1 - delta f1, %2 - delta f2

    this.deltaPrecision = 2; // delta precision
    this.pSeparator = " "; // peak separator

    this.start = "<html><head><title>Peak Report </title></head><body>" + this.font;
    this.end = ".</font></body></html>";
}

MyPeakReporter.prototype = new PeakReporter();
MyPeakReporter.prototype.toString = function() { return "MyPeakReporter()"; }

//This line adds my custom reporter to the list of reporters, this means that this reporter can be used by the functions like reportPeaksUser or
automaticPeakReport and then it can be used to generate reports from the Peaks Table
Env.PeakReportersArray.push(new MyPeakReporter());

//Uncomment this line to make this reporter the default reporter, the saved settings will be ignored, the user will not be able to modify the reporter from
MNOva
//Env.DefaultPeakReporter="My Peak Reporter";

//This function can be used to generate peak reports
function customReportPeaksUser(createItem)
{
    var peakTable = new PeakTable(nmr.peakTable()); // Get table of peaks
    var spectrum;
    if(peakTable.isValid())
        spectrum = new NMRspectrum(peakTable.spectrum()); // Get spectrum currently shown in the table of peaks
    else
        spectrum = new NMRspectrum(nmr.activeSpectrum());

    if( spectrum.isValid() )
    {
        var reporter = PeakReporter.getReporterByName("My Peak Reporter");
        return reporter.report(spectrum, createItem);
    }
    else
        return undefined;
}

```

How can I report the peak list of my ¹³C-NMR spectra?

It is really easy to report the peak list of any spectrum, just by right clicking on any toolbar to select 'Peak' in order to display the 'Peaks Table'. Once there, click on the 'Report Text' button to get the report in your spectrum.

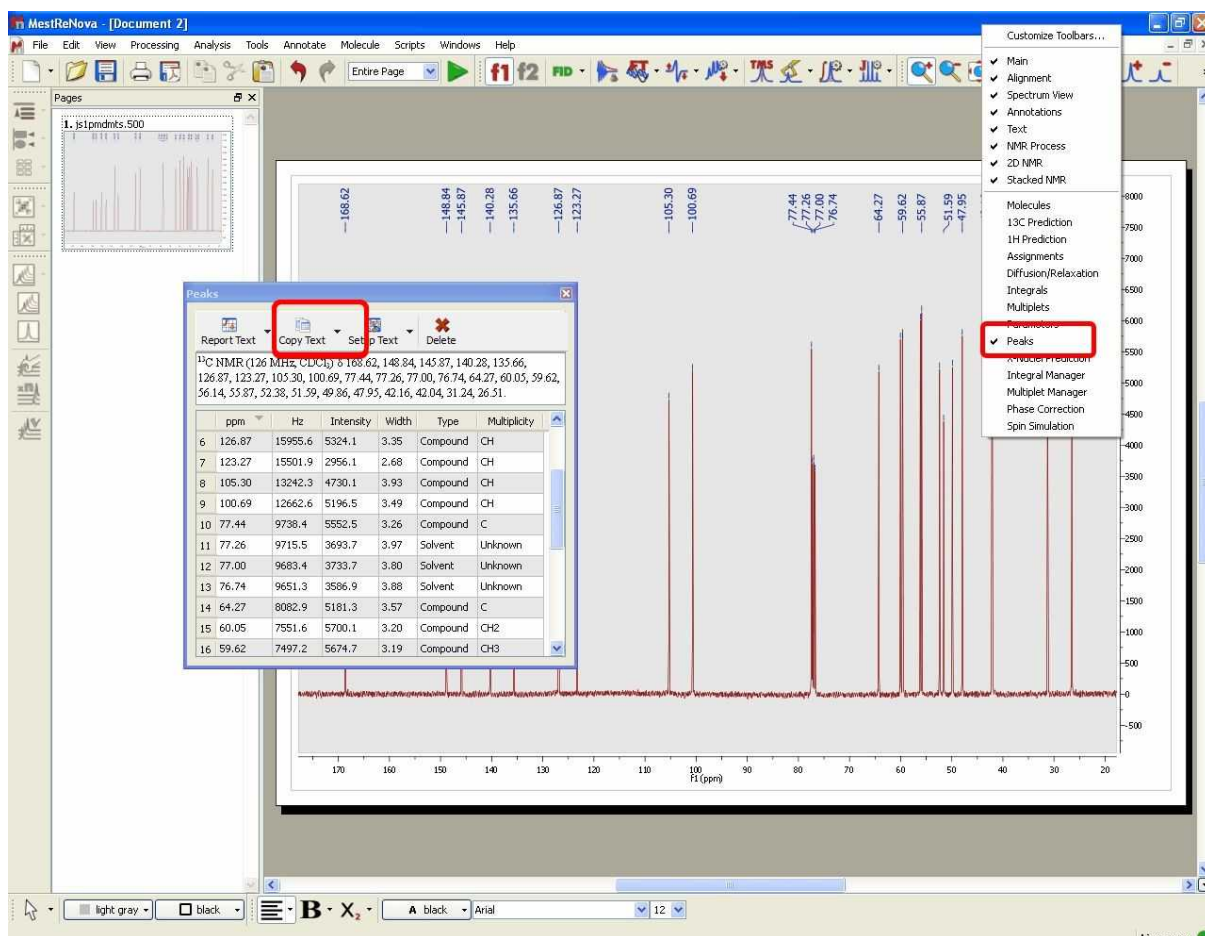

How can I report the peak list of my 2D-NMR spectra?

For 2D NMR spectra, you can modify the 'PeakReporter.qs' script (which is located in the scripts folder of Mnova) by just changing the **false** with **true** in this line:

```
//Report
f1 value
in 2D
spectrum

this
.reportf1
n2D=
false;
```

with: **this.reportf1In2D=true;**

and you will get a report like this:

NMR (400 MHz, CDCl₃) δ (8.62 147.34), (7.97 131.35), (7.94 131.37), (7.46 118.14), (7.32 121.23), (7.28 121.24), (7.21 101.03), (5.48 71.99), (4.91 114.03), (3.87 55.34), (3.11 59.66), (3.05 56.77), (2.65 56.82), (2.62 42.87), (1.78 27.53), (1.54 21.65).

See also:

[Peak Picking Properties](#)

9.3.4 Peak Picking Properties

The user can modify the properties of the **Peak Picking** by following the menu 'Edit/Properties/Peak Picking' or by double clicking the left mouse (or pressing the right mouse) button on the spectrum display and selecting *Properties/Peak Picking* from the *pop-up* menu.

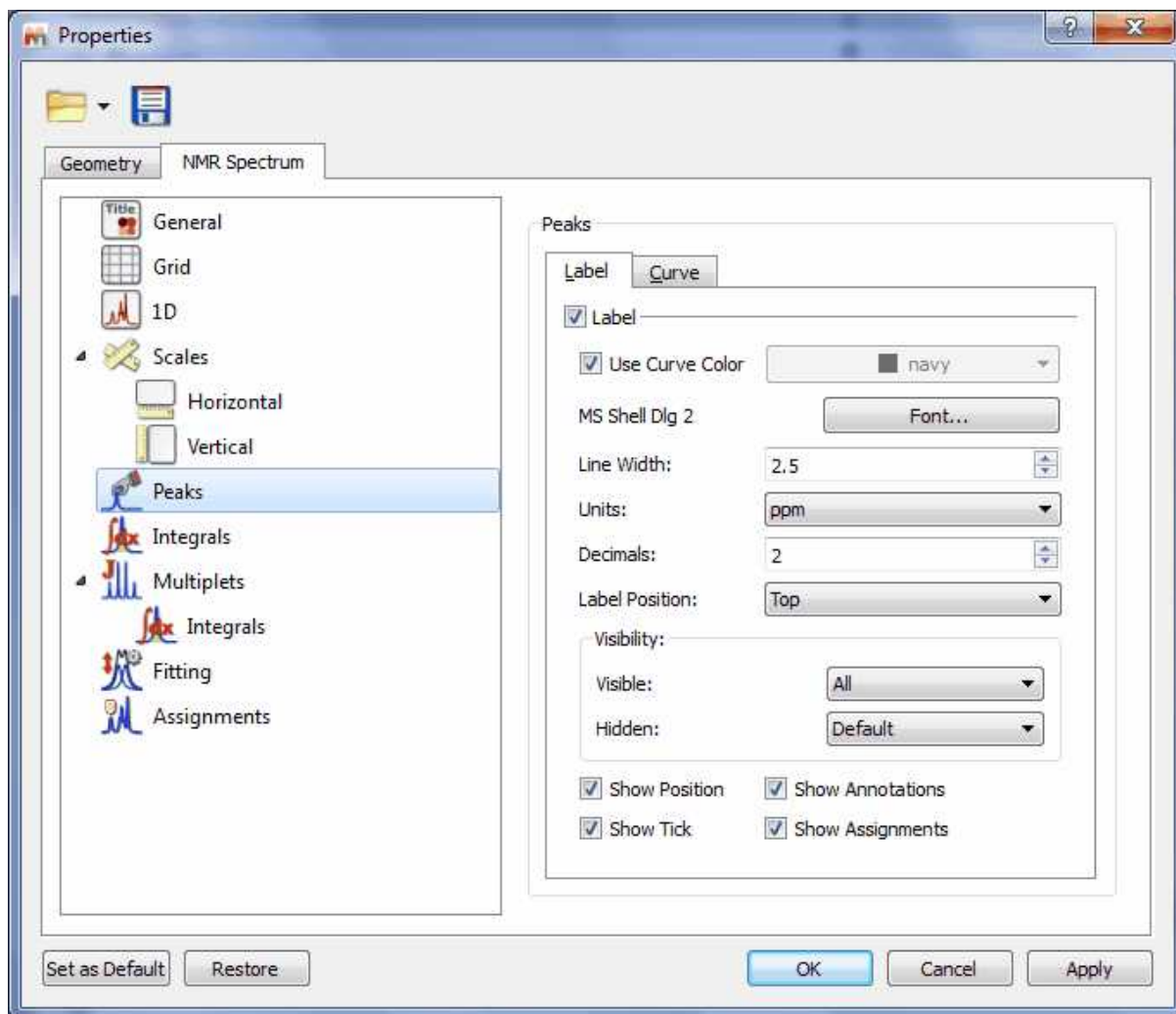

Then, the user can display or hide the peaks (according the peak type by selecting the applicable option in the scroll down menus) and to show/hide the Position, Annotations, Ticks or Assignments by checking (or unchecking) the applicable check box. It will be also possible to select the color, the font and the units (ppm or Hz) of the 'peak picking label'; the number of decimal figures to be shown on screen and the position of the 'peak labels'.

Clicking on the 'Curve' tab, you will be able to customize the color of peak curves (Peaks, Sum or Residual):

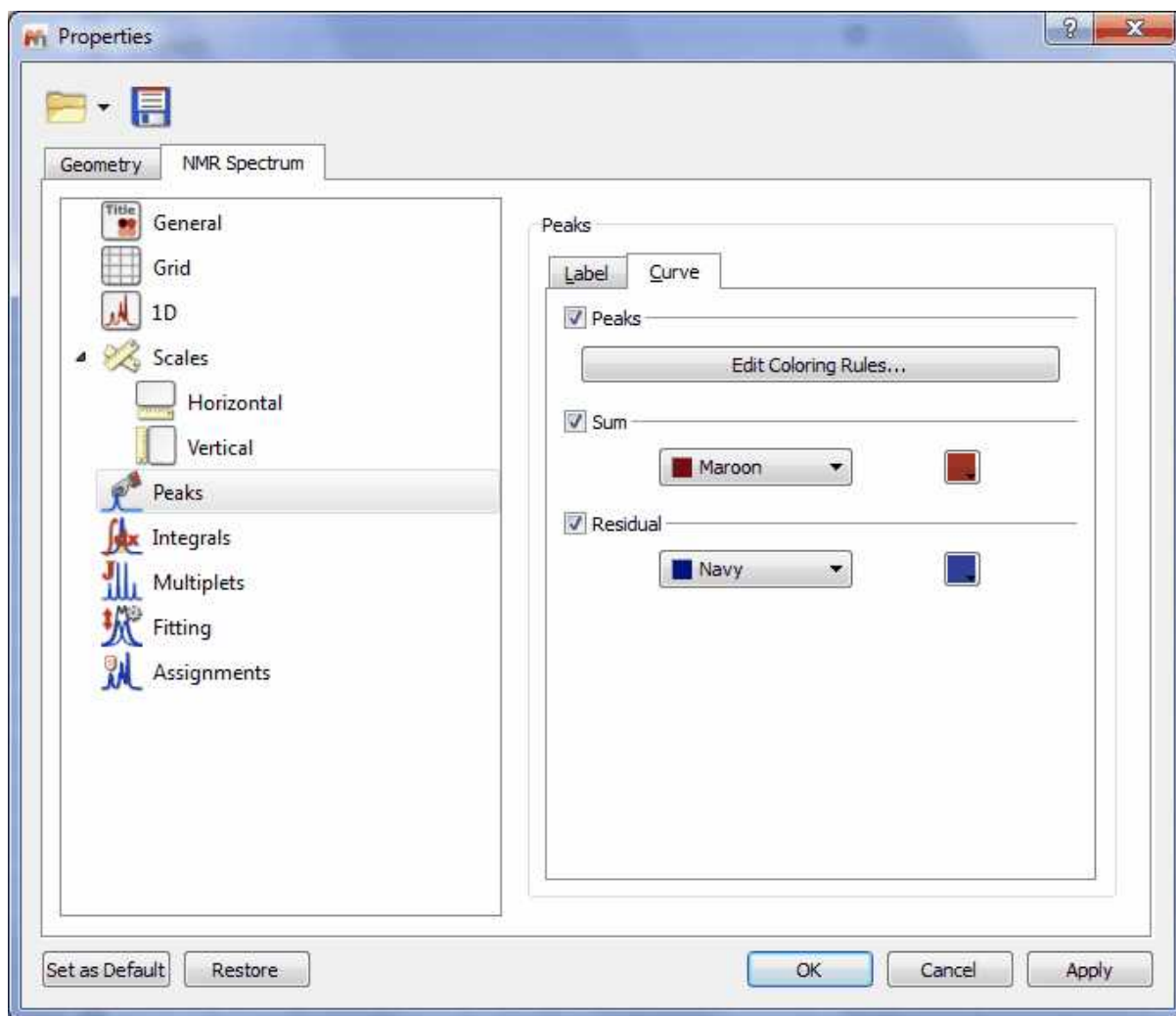

Clicking on the 'Edit Coloring Rules', will display a dialog box to allow you to create different colours rules depending on the peak type and flag:

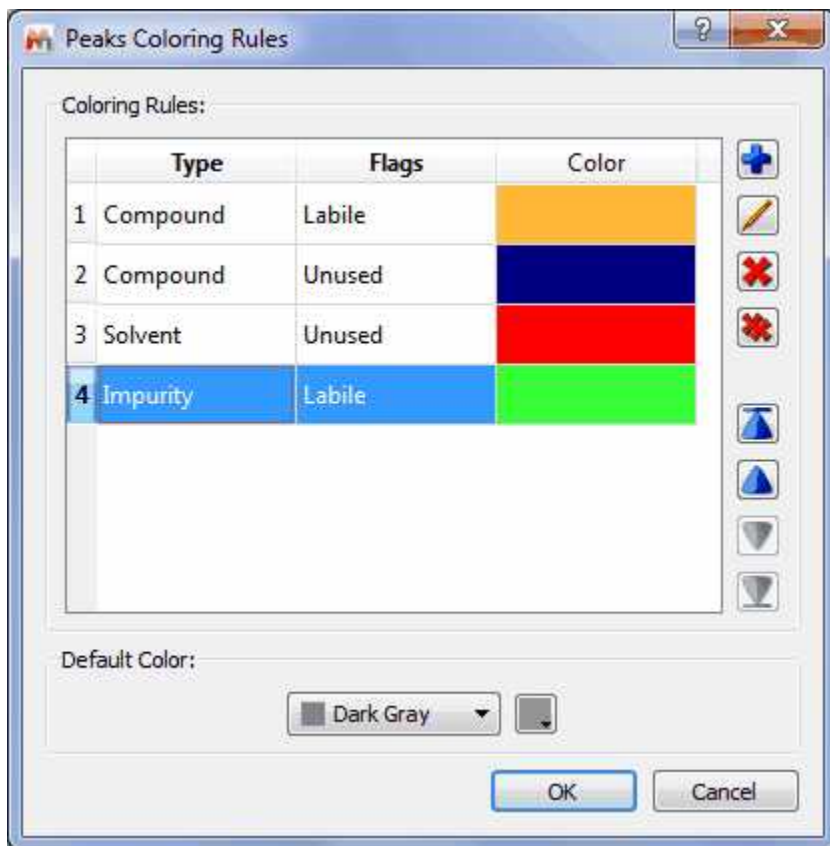

Let's see an example with different peak curve colours:

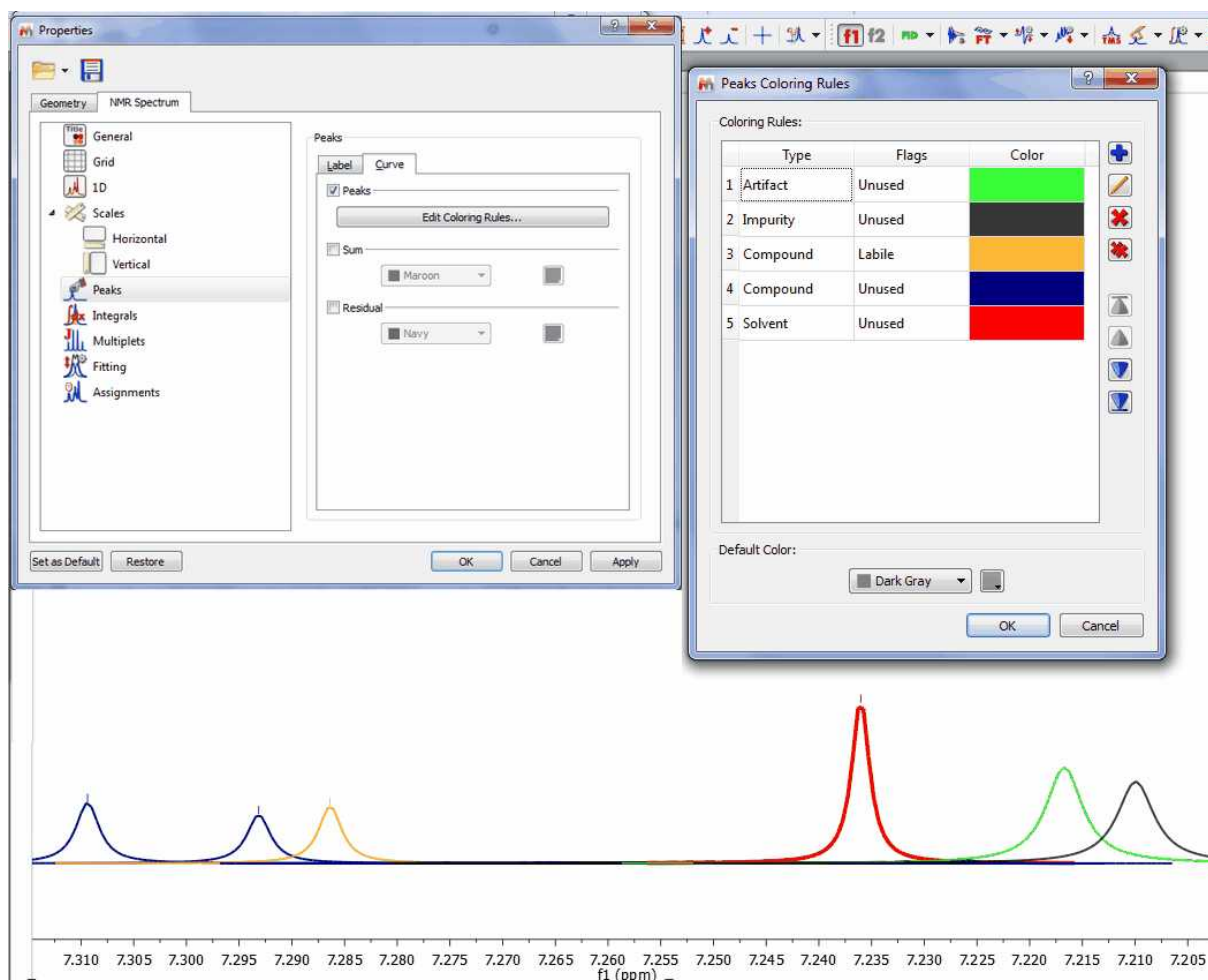

9.4 Integration

Spectral integration can provide invaluable quantitative information about a molecule as the integral of a spectrum indicates the number of nuclei which contribute to a given line (or set of lines).

Mnova implements a series of integration algorithms for both 1D and 2D data sets. These algorithms can be accessed via the menu item 'Analysis/Integration' or via the scroll menu immediately to the right of the '**Integration**' icon  on the toolbar. This scroll menu will allow you to use Automatic, Predefined or Manual Integration:

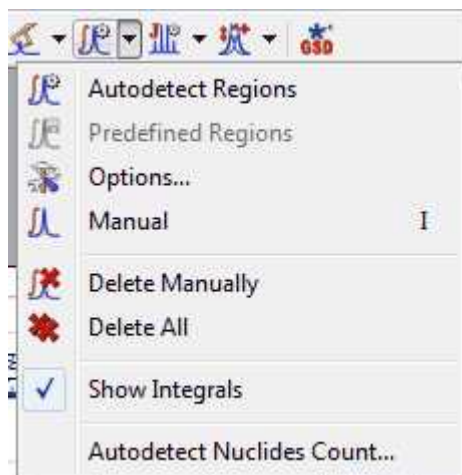

Autodetect Integration

1D spectra

The program automatically determines the regions containing signals. The algorithm uses the following options:

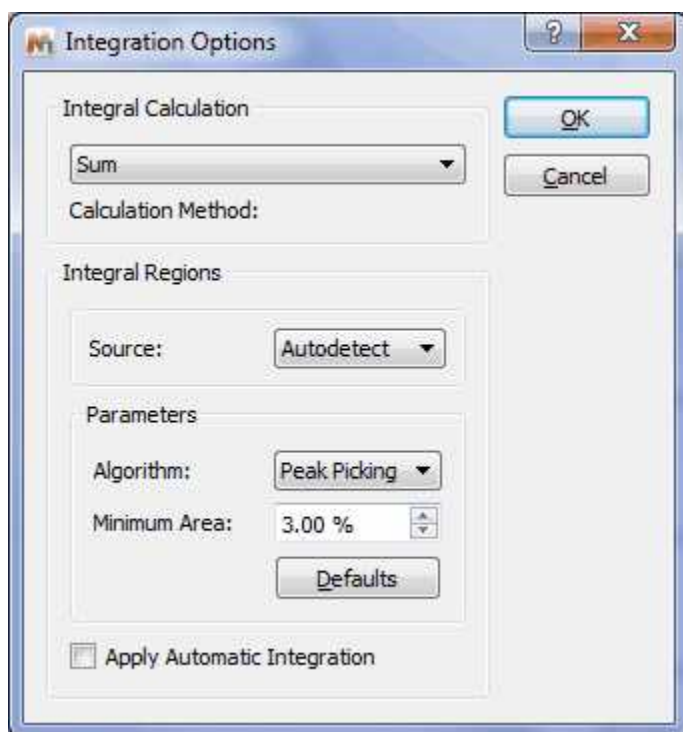

- **Calculation Method:** you can select between 'Sum' (classical integration, faster than 'Peaks' but without deconvolution) or 'Peaks' (it takes into account only the integrals of the GSD spectrum and because of the deconvolution applied, it is slower than the 'Sum' algorithm). In the Peaks calculation method, it will be possible to select what peaks you want to take into account for the integration (for example, only compounds peaks and not solvent or impurity peaks, etc...)

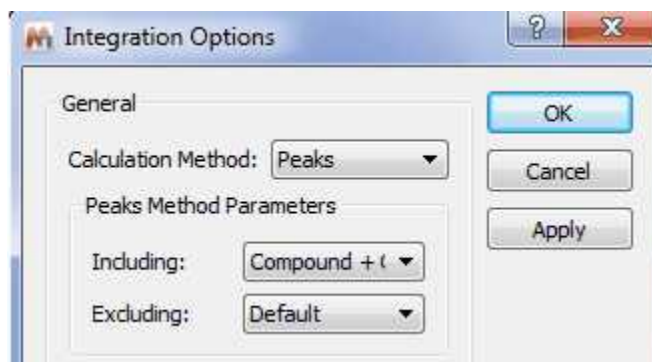

- **Algorithm:** you can select between the regular algorithm which is called 'Derivative' and the new algorithm based in the 'Peak Picking'.
- **Minimum Area:** Integrals with a value smaller than a given percentage of the largest integral will be discarded
- **Peak Picking algorithm:** this integral algorithm is based in the peak picking analysis. The user will be able to set the maximum value of the coupling constants (**J Max**), the **Peak Width Factor** and also the **Minimum Area** of an integral (integrals with a value smaller than a given percentage of the largest integral will be discarded)

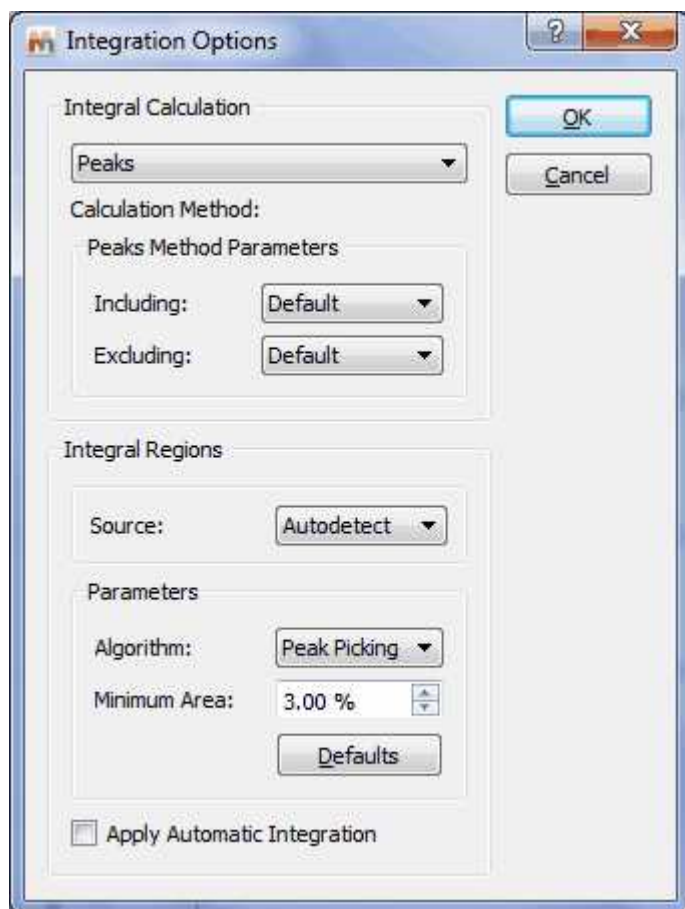

Bear in mind that this algorithm is based on the peak picking results. If no peak picking has been

applied, the program applies one on the fly automatically but the best way to proceed will be by first applying a peak picking to make sure that all the real peaks have been detected and, more importantly, artifacts and very small peaks (e.g. impurities) have not.

So as always, it will be a good idea to apply a baseline correction, followed by peak picking – In this case, it's important to ensure that the noise factor is right.

Once you're happy with the peak picking results, it's time to apply integration algorithm. The critical parameter is the 'peak width factor'; the larger this parameter, the wider will be the integral segments.

2D spectra

Automatic integration of 2D spectra is based on the [2D peak picking](#) algorithm. If no peak picking has been applied when the automatic integration command is issued, **Mnova** will automatically apply a 2D peak picking on the background and then, for every peak detected, it will find the applicable volumes. Thus, the options that control the [2D peak picking](#) procedure also apply to the 2D automatic integration algorithm.

A series of Automatic Peak Picking Options can be controlled on the 'Peak Picking Options' dialog box, which can be accessed via the Peak Picking scroll menu (see the 'Peak Picking' section of this guide). The user can choose the noise factor (the higher the factor the less peaks will be picked), the peak type, whether to use parabolic interpolation, merging options for 2D multiplets, maximum number of peaks, etc. All these options can be evaluated interactively, so that their results can be viewed on screen in **real time**, by making sure the '**Interactive**' box is selected.

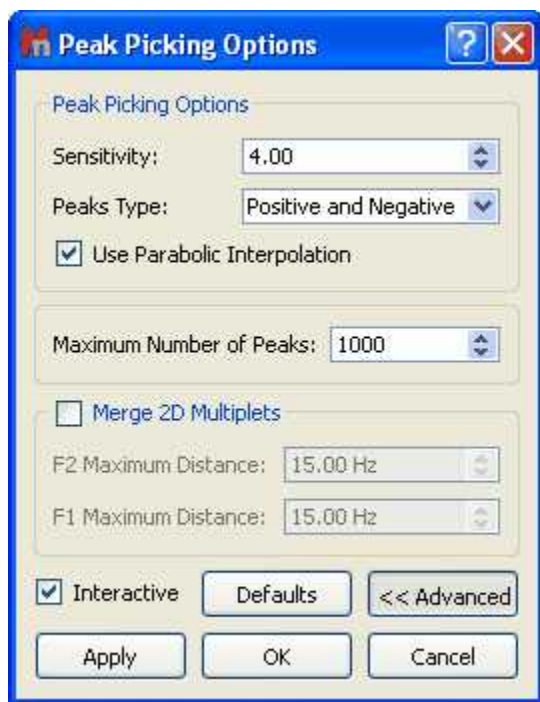

Peak volume integration in Mnova is measured as the sum of all digital intensities within the integration area (footprint). This footprint can be of 2 shapes: rectangular or ellipsoid footprints. In low resolution spectra with no significant fine structure, the ellipsoids footprints fit well, whereas higher resolution spectra tend to show rectangular patterns according to the projections of the correlated individual multiplets.

The default setting is with ellipsoids. But you can change it to rectangular in the integration options.

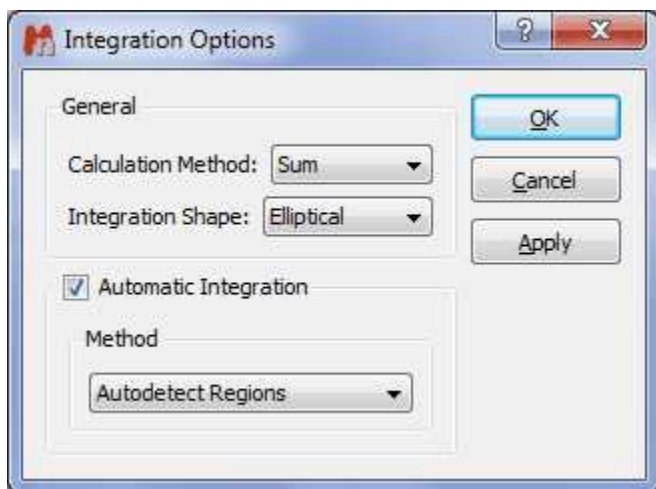

By the way, you can also manually change the size of a footprint by click-and-drag on one of the edges of the footprint.

See [Integral Properties](#)

Predefined Regions Integration

The user will be able to predefine the integral ranges to automate the integral analysis. Just go through the following procedure:

1. Open the 'Integral Option' dialog box (by clicking on 'Options' in the 'Integration' scroll down menu) and select the Method: '**Predefined Regions**' as is shown in the picture below:

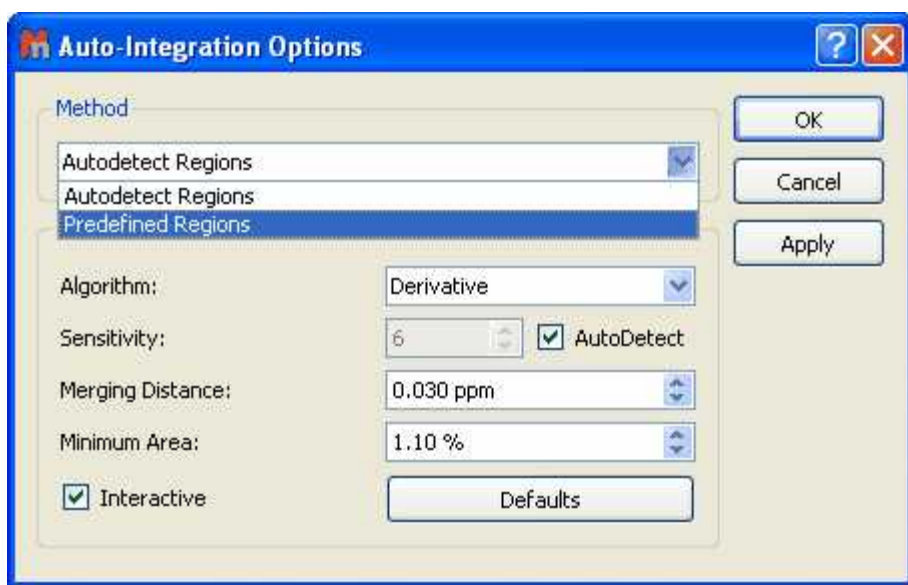

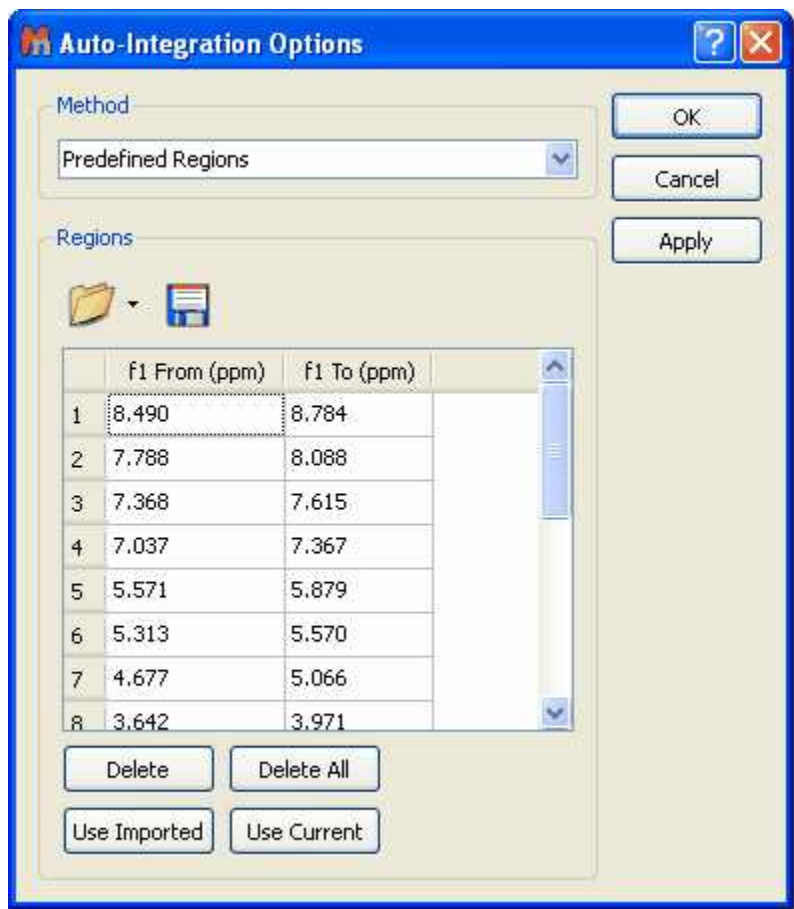

2. This will display a new dialog box, where the user will be able to select the desired ranges to apply the integration. If you have already integrated the spectrum you can click on the 'Use Current' button to

import the integral ranges:



Clicking on OK, will apply the integrations to the current spectrum and keep the regions to apply further integrations to additional spectra by just clicking on 'Predefined Regions' in the Integral scroll down menu:



The user will be able to save these regions for later uses, by clicking on the 'Save Integral Regions' icon  which will be loaded by clicking on the 'Load Integral Regions' icon . It is also possible to save the integral regions by following the menu 'File/Save as' and selecting 'MestReNova Integral Regions'.

You will also be able to use the original Bruker integrals by using the 'Use Imported' button. Please bear in mind that if you import a Bruker file with MNova, the integrals will appear automatically, however if you open an old Mnova-document with Bruker data then this button is the way to use Bruker ranges. With the 'Use Imported' button you will be able to reload the original Bruker integrals.

It is also possible to copy&paste the spectral regions from one spectrum to another, just by pressing 'Ctrl+C' in the original spectrum and then following the menu 'Edit/Paste Properties/Paste NMR Integrals' in the other spectrum (or spectra, if you have previously selected them in the page navigator):

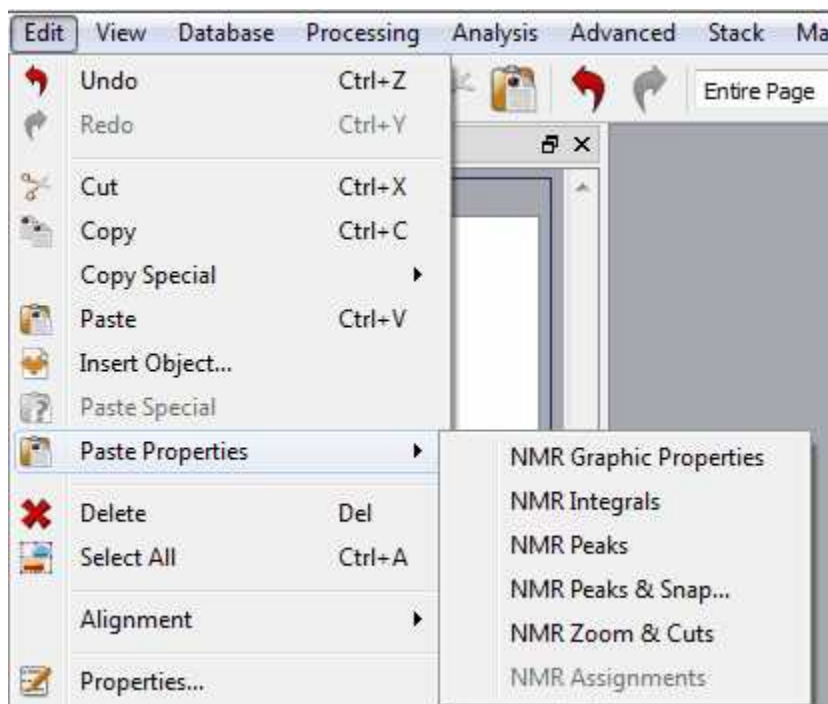

The integral list can also be exported as an ASCII file by following the menu 'File/Save as' and selecting 'Script: Integrals 1D (*.txt)' (or 2D depending on the dataset). It will be possible to export the integral series and tables:

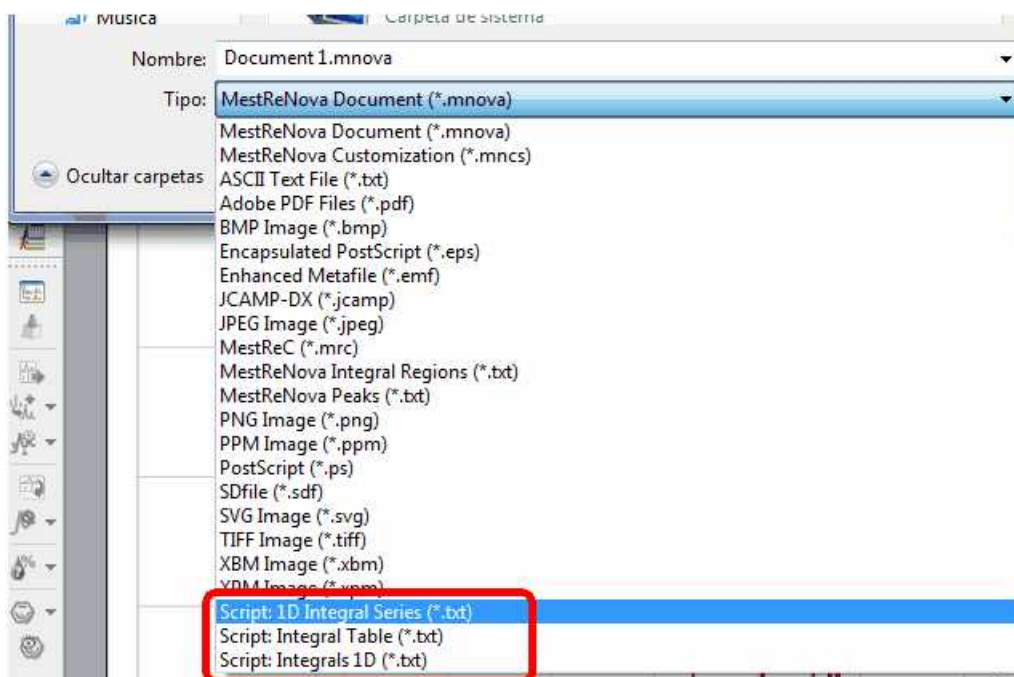

Manual Integration (shortcut: I)

First, select integration mode by clicking on the Manual integration command as depicted below:

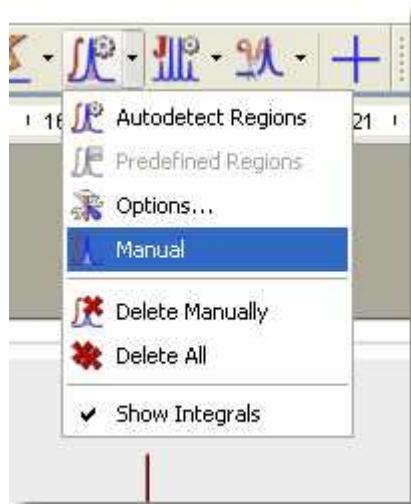

- Next, click and drag with the mouse to select the area to be integrated
- The first integral will be normalized to 1.0. All following integrals will be referenced relative to the first integral.

It is possible to save the integrals list as a 'text file' by following the menu 'File/Save as' and selecting 'MestReNova Integrals (*.txt)'

Integral Settings:

Setting integrals with Mnova is very easy and intuitive. All the integral curves are mouse-sensitive and they respond to usual mouse operations. If you want to move up or down all the integrals, just click and drag (with the left mouse button) over anyone of the integrals (notice that hovering the mouse over the integral will highlight it in red). If you keep pressed the SHIFT key at the same time, the height of the integral curves will be changed.

The same effect will be obtained if you hover the mouse over integral curve, click on one of the green squares and drag the mouse up or down. If you want to change the range of the integral, do the same with the integral label (notice that once you hover the mouse over the green squares of the integral curve or label, the mouse pointer turns to vertical or horizontal arrows, respectively).

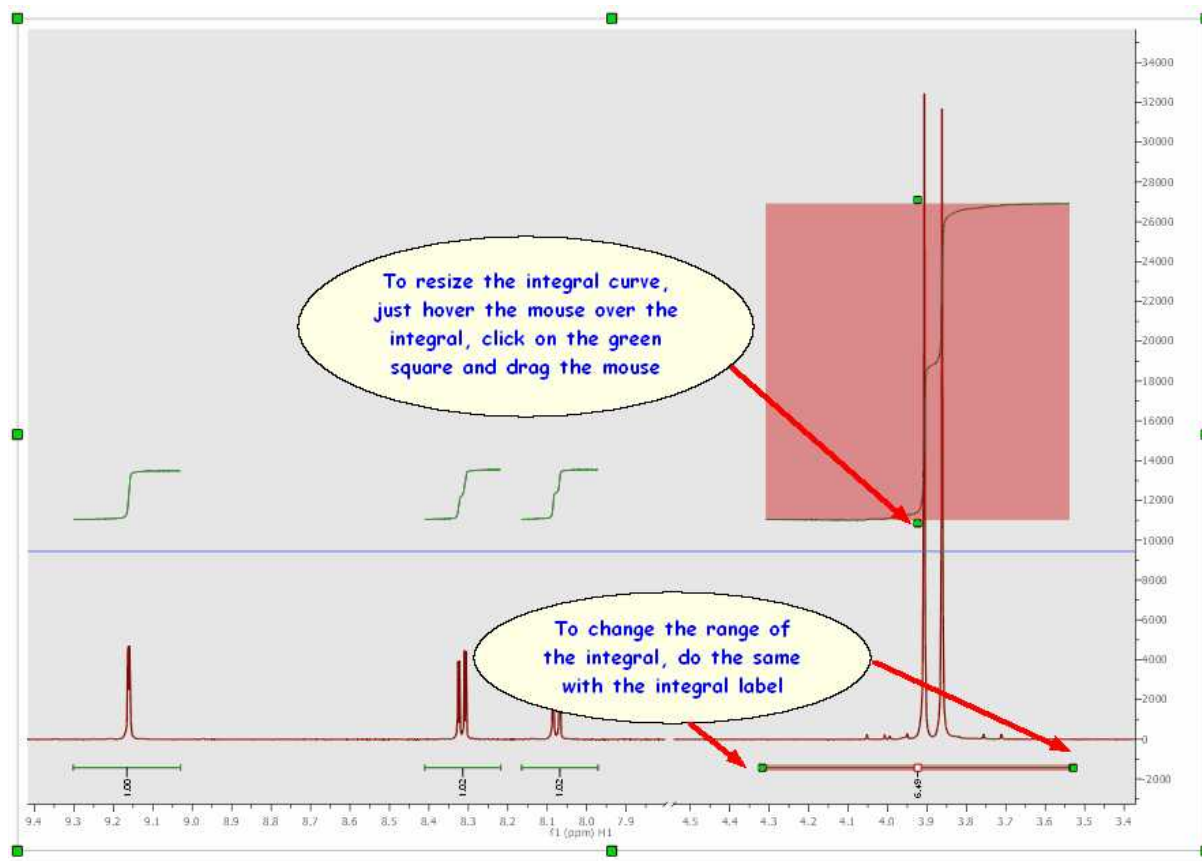

Cutting Integrals: It is possible to divide any integral just by clicking on the red square of the integral label and dragging the mouse as you can see in the picture below:

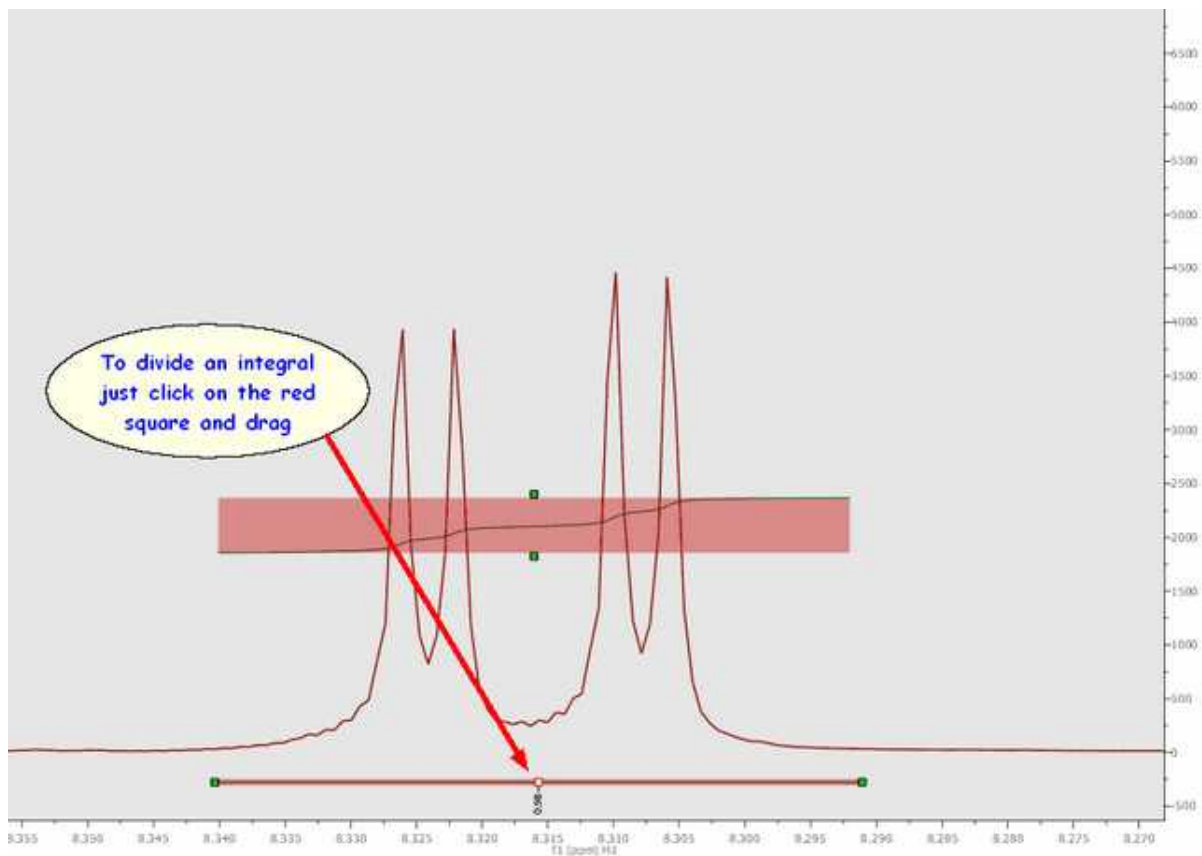

Integration Manager (shortcut: Shift+I): The integral editor will be displayed by double clicking on any integral curve, as you can see in the figure above. From there, you can change the integral range, normalize the integral to a specific integral, navigate through them and also to reference integrals to the total integral value for the spectrum.

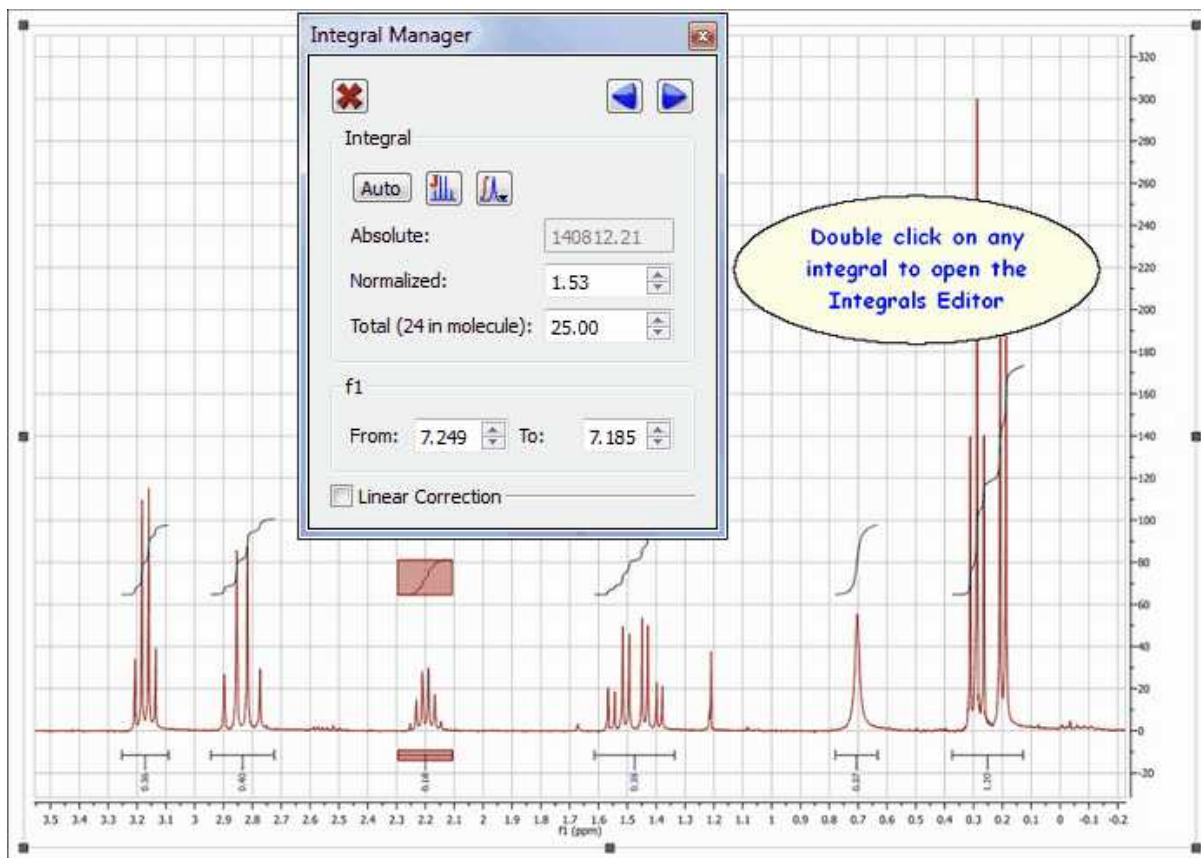

Please note that the 'Integral Manager' dialog is **modeless**, so you will be able to use any other tool (i.e. zooming) whilst you are applying the analysis.

The user can resize the limits of the integral by using the arrow buttons  or entering the desired value on the applicable edit box:



Bear in mind that you are able to navigate over the integrals by using the **'Previous or Next'** icons.

If you want to resize the height of the integral curve, just hover the mouse over one of the integral curves and hold down SHIFT, click on left mouse button and drag up or down (to increase or decrease the height).

If you want to normalize the integrals, just overwrite the desired value on the 'Reference edit box' (on the Integrals Editor) and press OK, all integrals will update with reference to the chosen one. The user can also delete an integral one by one by clicking on the 'Delete' button.

It will be possible to apply the same integral normalization to all the spectra (in the current document) or to all the traces of a stack plot by selecting the applicable option, as you can see below. This is very

useful if you need for example to determine relaxation times from a series of 1D spectra, to be able to compare the integral values between the different traces.

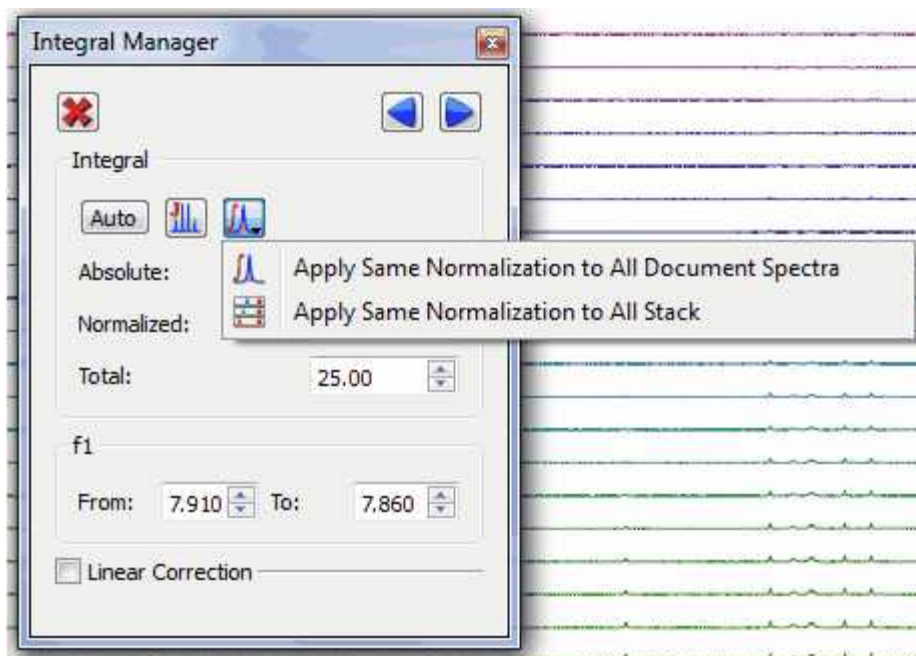

Linear Correction: Linear correction is basically a straight line built connecting the left and right boundaries of every integral in such a way that the final area will include only the integral above that line. In other words, if A is the total area under the peak(s) and B is the area under that straight line, the reported integral R will be:

$$R = A - B$$

Mnova has an option to automatically calculate this straight line. In order this to work properly, it's recommended to have a good digital resolution (e.g. by applying ZF), as the program utilizes 3 points at both edges of the integral to build the straight line.

If you want to apply an integral correction or rather, a linear baseline correction just on the integral

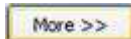

region, just click on 'More >>' button, this will display the 'Linear Correction' dialog box, where you will be able to adjust the *Bias* and *Slope* parameters.

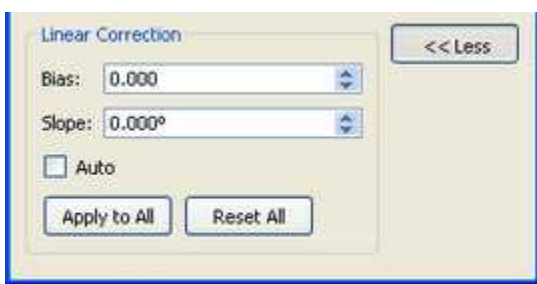

Use the controls for *Bias* and *Slope* correction as follows:

- Adjust the *Bias* parameter until the initial (left) part of the integral is flat.
- Adjust the *Slope* parameter to flatten the top (right) part of the integral curve.

The *Auto* box computes the *Bias* and *Slope* values automatically.
The button *Apply to All* is used to correct all the integrals simultaneously.

We strongly recommend to correct the baseline prior integration using any of the baseline correction algorithms.

Likewise, if you press the right mouse button on an integral, you will get a pop-up menu with the following options:

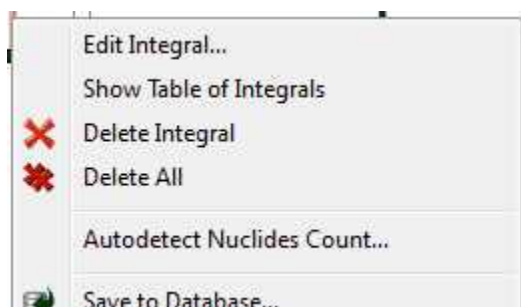

Edit Integral: displays the Integration Manager dialog box.

Show Table of Integrals: to show the integrals table

Delete Integral: deletes the current integral.

Delete All: deletes all integrals.

Autodetect Nuclides Count: this command will be very useful to count the nuclides present in any spectrum. In this case, it is shown the $^1\text{H-NMR}$ spectrum of the quinine. We have applied the 'Nuclides Count' algorithm after the integration and the result is that the number of protons is 24 (which is consequent with the molecule).

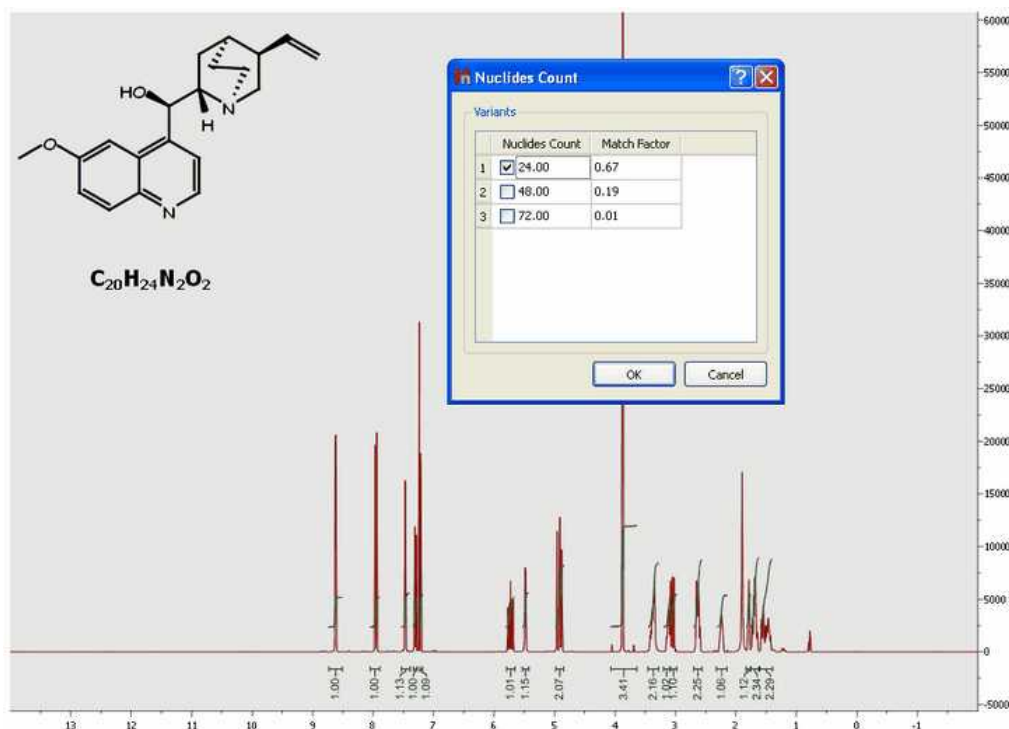

Integration only gives information on the relative number of different nuclides. From a practical stand point, first the absolute integral values are computed and then the integrals are normalized

(referenced).

For example, if we know that a given integral corresponds to a CH₃ group, we can set it to a value of 3 so that all other integrals will be scaled accordingly. Note that these values are not exact integers and need to be rounded to the nearest integer to obtain the significant value. But that means that the reference should have correct intensity to start with, which is not guaranteed.

Our goal is to automate this process, that is, starting from the absolute integral values, automatically select the reference group and scale the remaining values in order to obtain the correct number of nuclides.

It is a simple algorithm to auto normalize the ¹H NMR integrals without prior-knowledge. It will be useful especially for auto batch processing using the scripts of Mnova.

Starting from this situation:

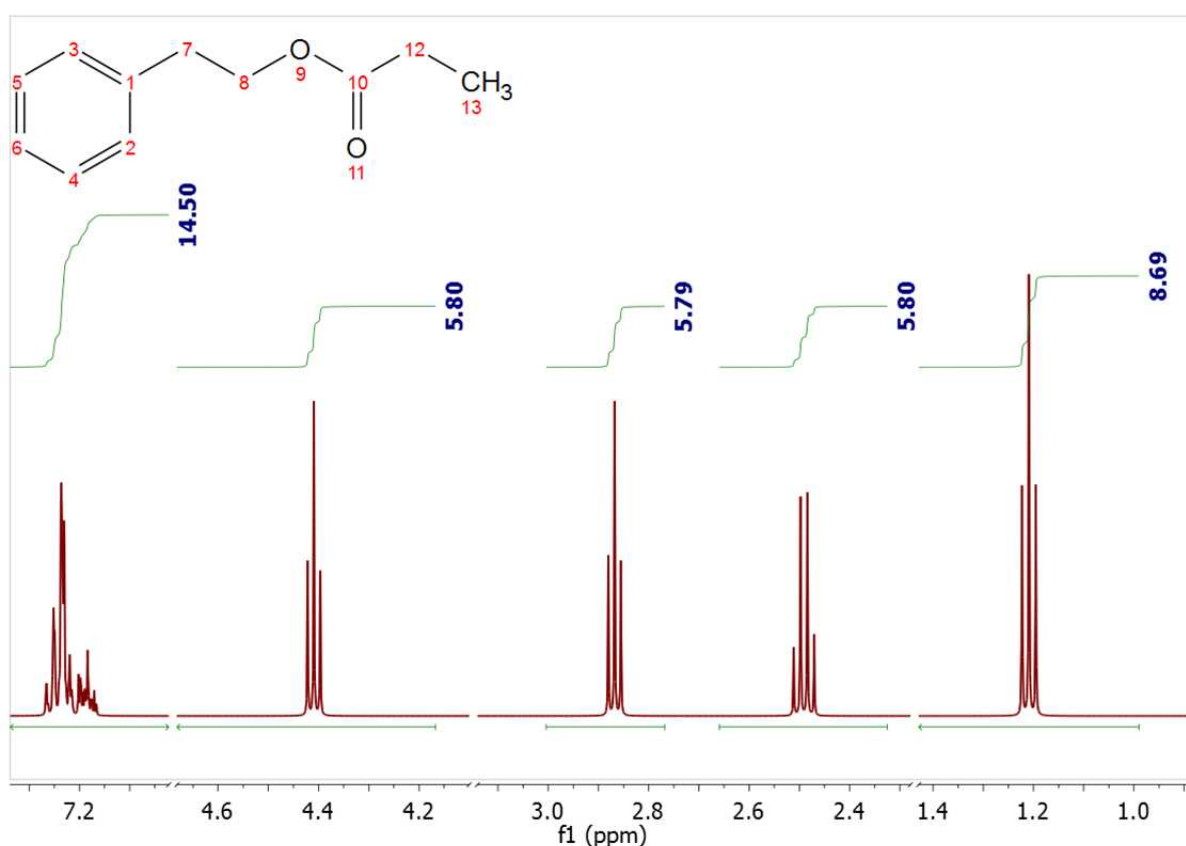

We can arrive to this one after having applied the algorithm:

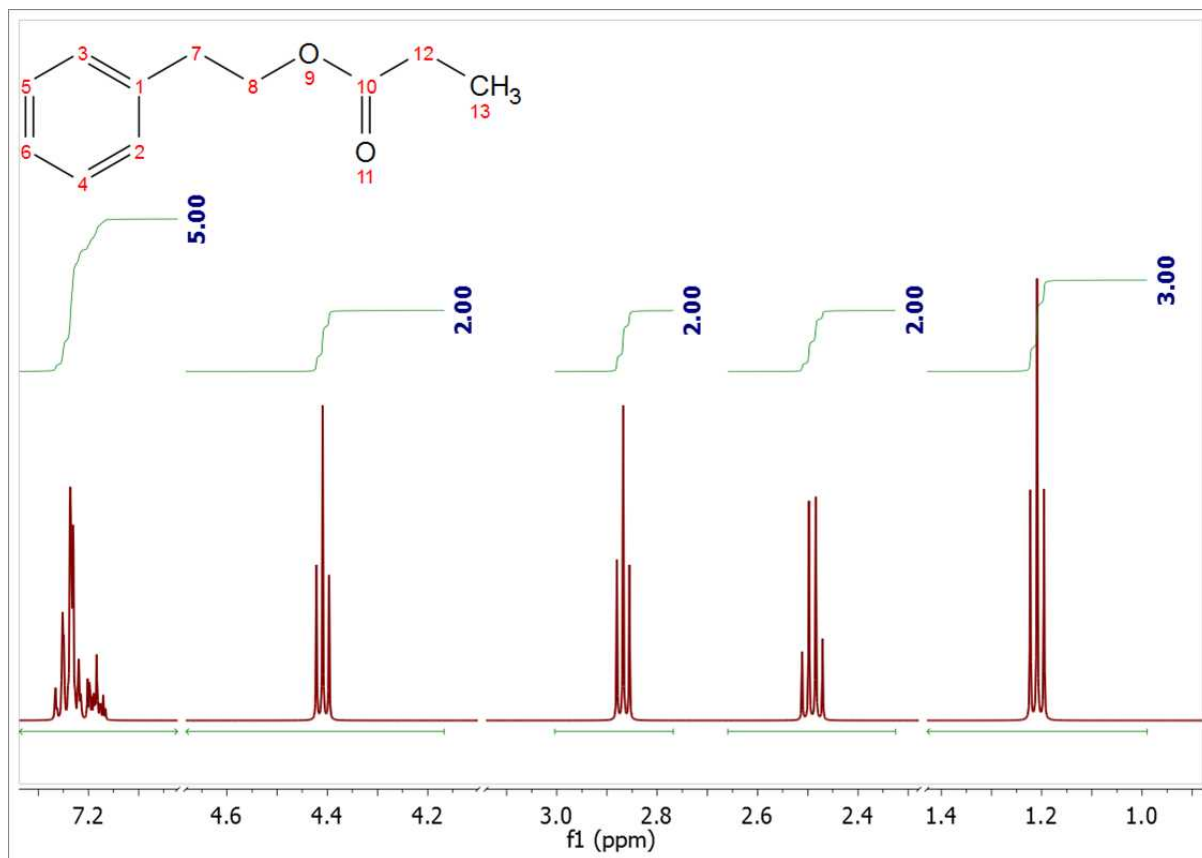

See also:

[Integral Properties](#)

9.4.1 Integrals Table

The Integrals Table (by following the menu: 'View/Tables and then select: Integrals') includes information about the integral range (in ppm) and the normalized and absolute values of each integral.

In this table the user can delete a desired integral by clicking on the **'Delete'** icon . The user can also normalize the integrals by double clicking on the normalized value of the integral which the user would like to set (in the red square on the capture below). Once it is highlighted, the user has to overwrite the desired value, press return, and all integrals will update with reference to the chosen one.

This method is an alternative way to normalize integrals. The user can obtain the same result by double clicking directly on the integral curve on the spectrum, as we have explained in the chapter above.

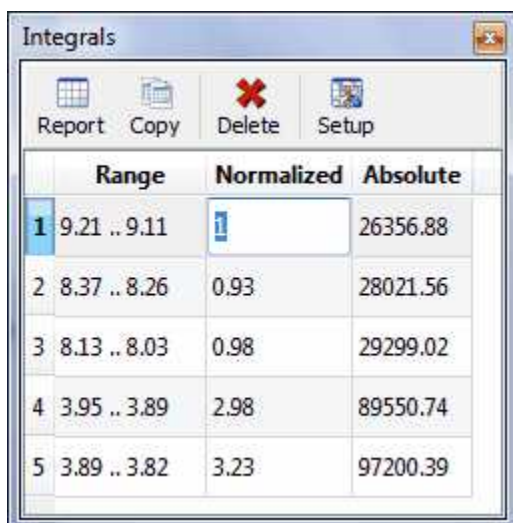

The screenshot shows a window titled "Integrals" with a toolbar containing "Report", "Copy", "Delete", and "Setup" icons. Below the toolbar is a table with three columns: "Range", "Normalized", and "Absolute". The table contains five rows of data, with the first row highlighted in blue.

	Range	Normalized	Absolute
1	9.21 .. 9.11	1	26356.88
2	8.37 .. 8.26	0.93	28021.56
3	8.13 .. 8.03	0.98	29299.02
4	3.95 .. 3.89	2.98	89550.74
5	3.89 .. 3.82	3.23	97200.39

It will be also possible to normalize on the sum of several integrals; to do it, highlight the applicable integrals in the Integrals table, right click and select "Normalize" in the context menu. From there you can set the total value to normalize:

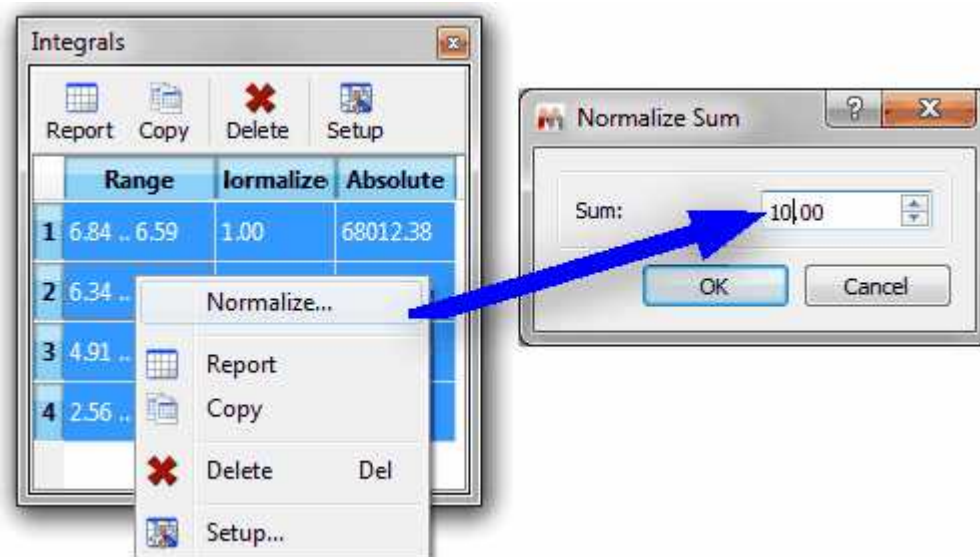

9.4.2 Integral Properties

The user can modify the properties of the integrals by following the menu 'Edit/Properties/Integrals' or by double clicking the left mouse (or pressing the right mouse) button on the spectrum display and selecting *Properties/Integrals* from the *pop-up* menu.

The options are different in 1D and 2D-NMR:

1D Spectra

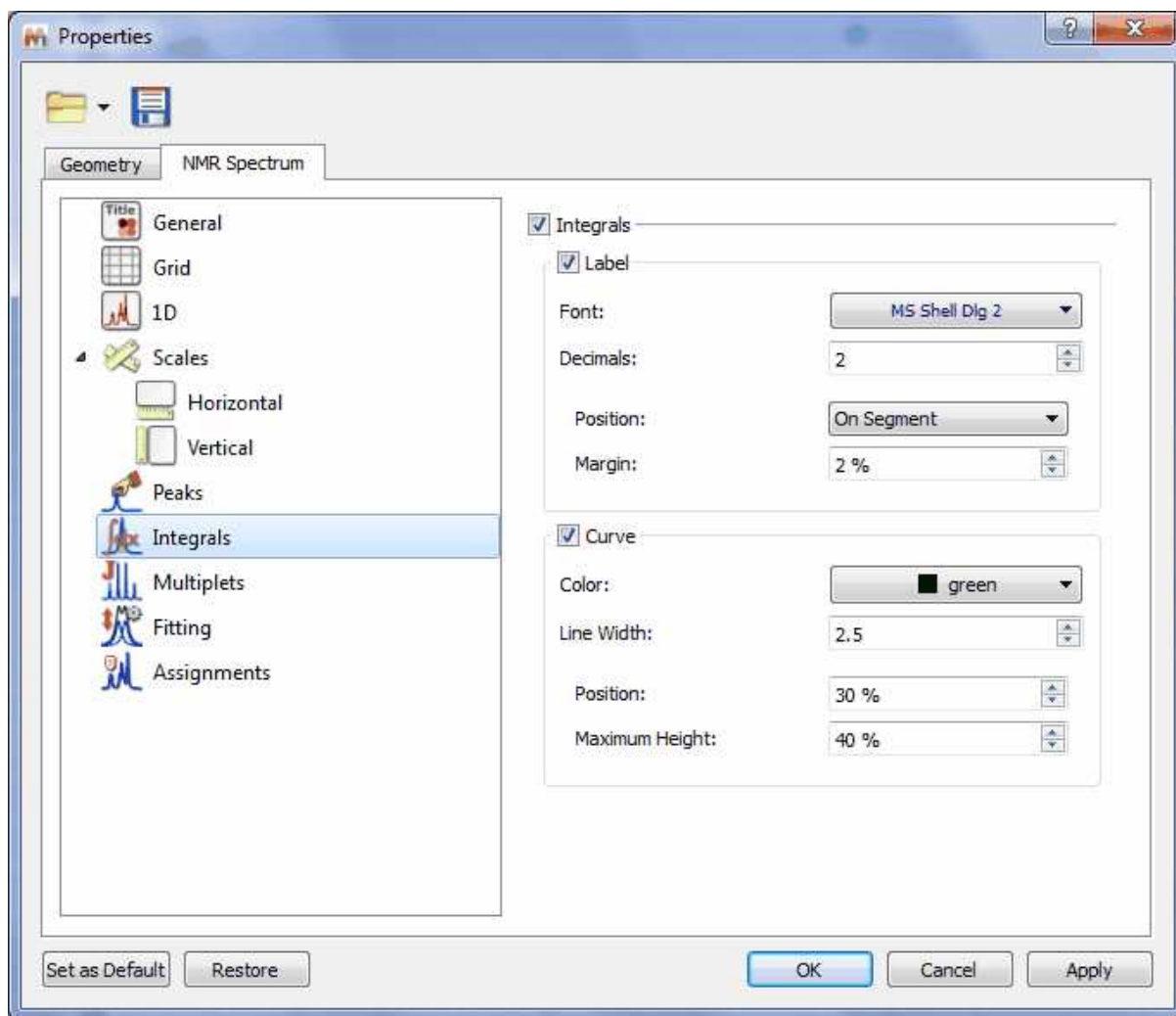

Integrals: Check/Uncheck this option if you want to display/hide the integrals (labels + curves)

Label: Check/Uncheck this option if you want to display/hide the integral labels

Font: Select the font type

Decimals: Select the number of decimal figures to be shown on screen

Position: Use this option to show the integral label on the curve or on the integral segment

Margin: distance (in % with respect to the spectrum item height) from the top

Curve: Check/Uncheck this option to show/hide the integral curves

Color: Select the curve color

Line Width: to select the width of the line of the integral curve

Position: distance (in % with respect to the spectrum item height) from the top

Maximum height of the integral curve.

2D Spectra

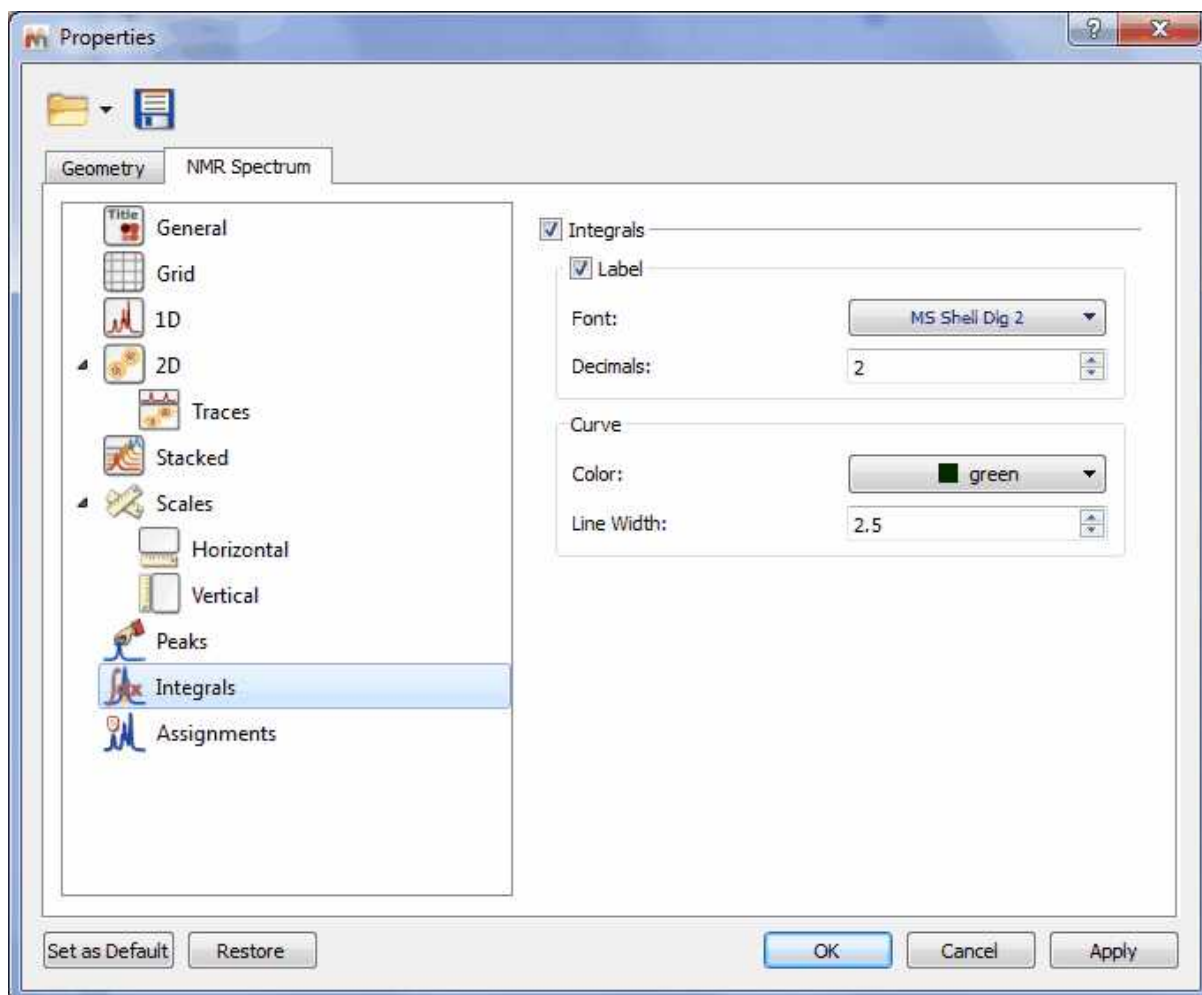

Integrals: Check/Uncheck this option if you want to display/hide the integrals (labels + curves)

Label: Check/Uncheck this option if you want to display/hide the integral labels

Color: Select the integral label color

Font: Select the font type

Decimals: Select the number of decimal figures to be shown on screen

Curve: Check/Uncheck this option to show/hide the integral curves

Color: Select the integral color

Line Width: Select the width of the line of integral curve

9.5 Multiplets analysis

(Not available in Mnova Lite)

You will find the quinine datasets in the installation folder of Mnova (under the examples/datasets folder)

Mnova incorporates an intuitive and powerful multiplet analyzer. The user will carry out an automatic multiplet analysis by clicking on its respective icon, placed on the analysis toolbar menu , or by following the menu 'Analysis/Multiplets Analysis/Automatic'.



Bear in mind that when you select an automatic multiplet analysis, Mnova will take into account the [Multiplet Analysis options](#)

See also this [chapter](#) about using GSD for multiplets analysis.

The user can also apply a manual integration followed by an automatic multiplet analysis (to obtain the same ranges in both cases), but please bear in mind that **integrals and multiplets are two independent lists**, so you will be able to have different ranges in both. In that case where the multiplets are made from integrals, MNova visualizes only multiplet integrals.

In the picture below, you will see the result of having applied an automatic multiplet analysis and selected '**Report Multiplets**' in the context menu of the multiplet box (which can be accessed by right clicking on it). The same result will be obtained by selecting 'Report Multiplets' in the multiplets scroll menu.

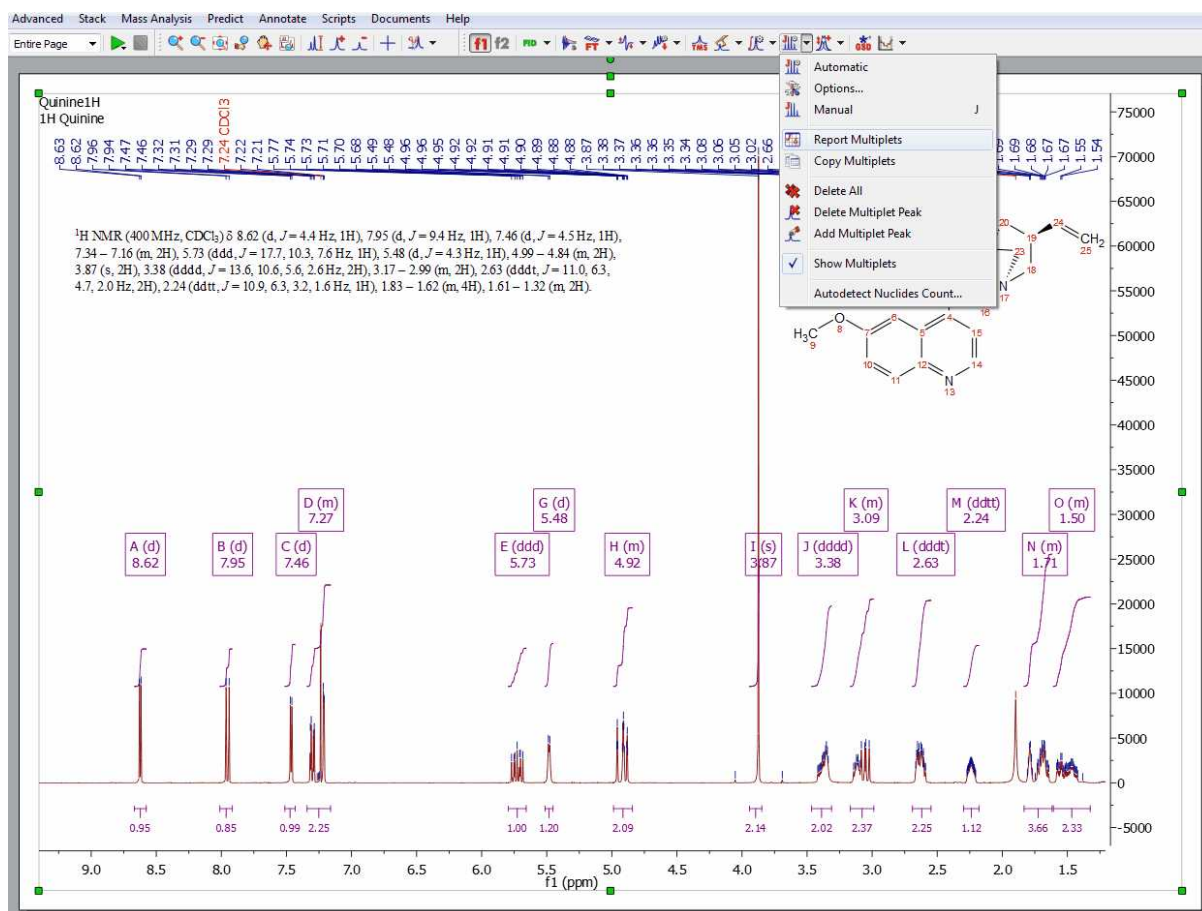

Another valid workflow would be to press the 'J' key to activate the manual multiplet analysis and click&drag on the regions that you want to analyze. You will not need to use the integration at all.

If you want to show the integral curves of your multiplets, just double click on the spectral window to display the 'Properties' dialog box and check the applicable box:

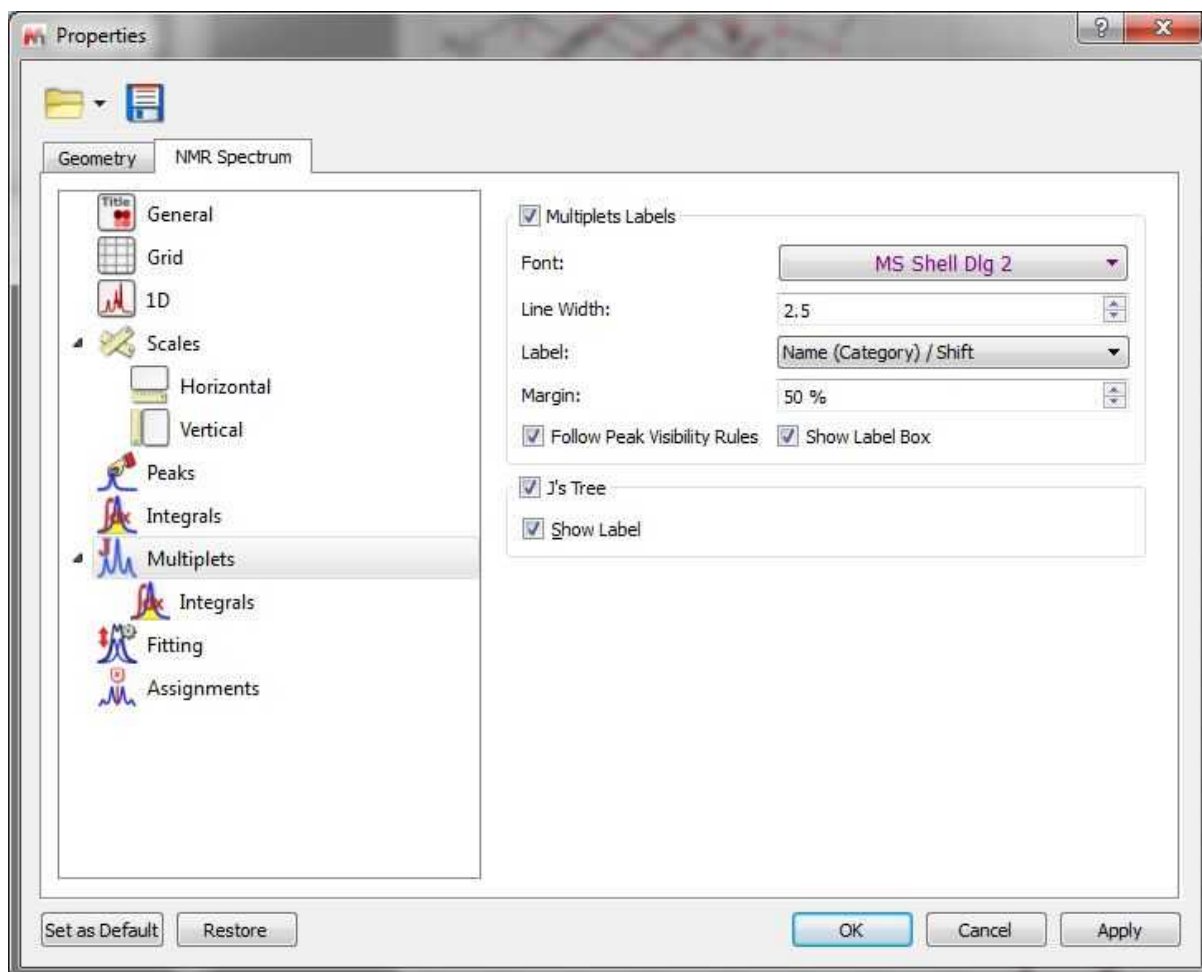

You can export the multiplet integrals list by following the menu: 'File/Save As:/Script: Multiplet Integral' or 'Script: Multiplet Integrals Series' if you work with arrayed spectra.

9.5.1 Multiplet Manager

The user will be able to set the multiplet parameters by double clicking on the magenta square (shortcut: Shift+J) containing the multiplet information.

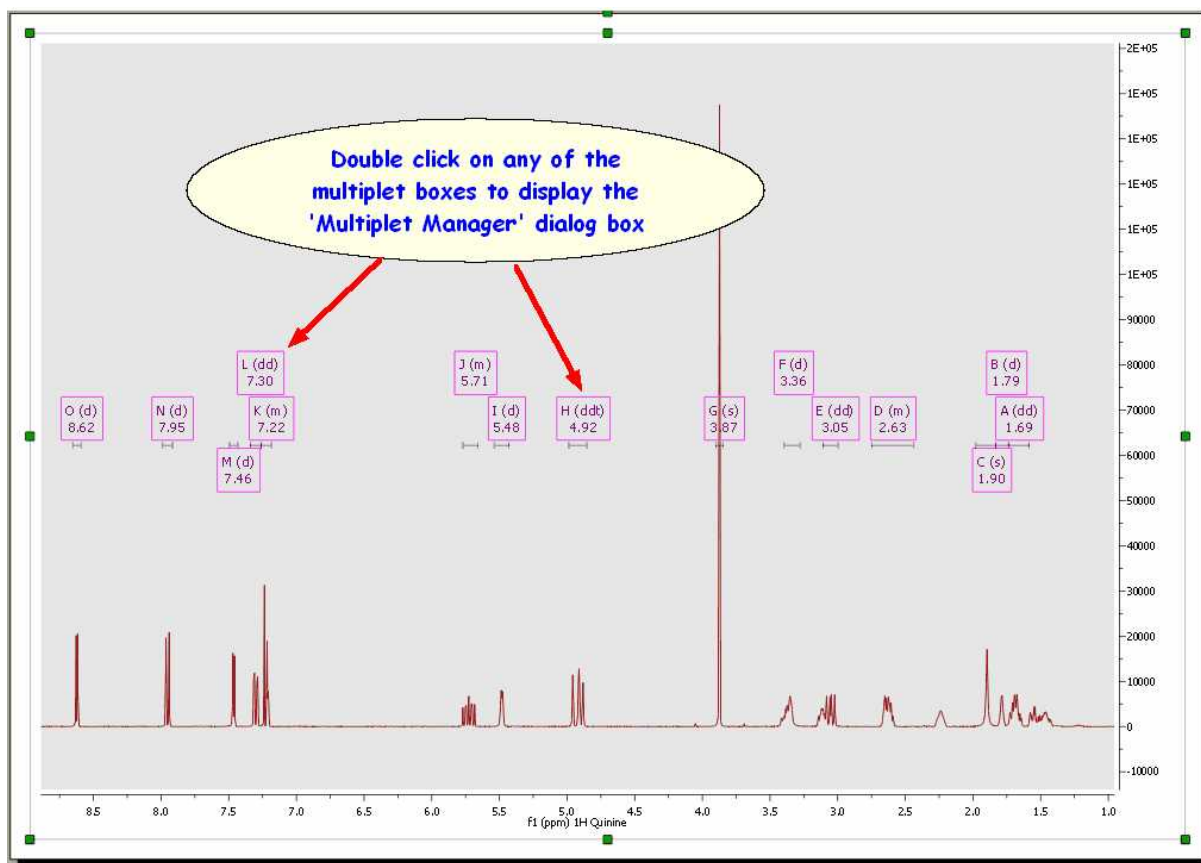

This will display the 'Multiplet Manager' dialog box, where you will be able to modify the multiplet limits as well as to normalize the values or report the multiplets just by clicking on the applicable button .

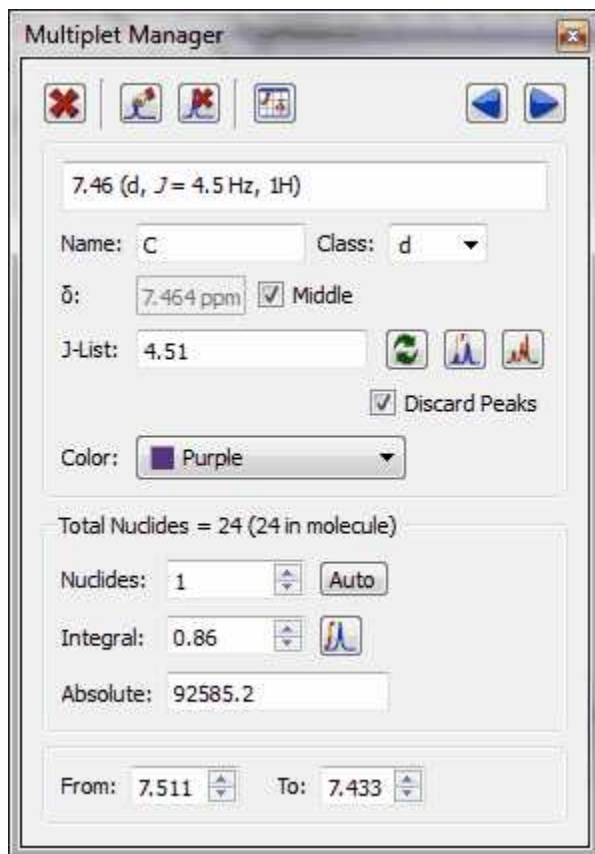

From this dialog box, you will also be able to change the name, class (it will be possible to add new classes to the drop down menu just by typing the name and pushing Enter key), the coupling constant tolerance limit and the color of the multiplet box. Please bear in mind that if the class of the multiplet is called 'mx' (being x any letter); the multiplet will be reported as a chemical shift instead of the multiplet range.

Here you can see the difference:

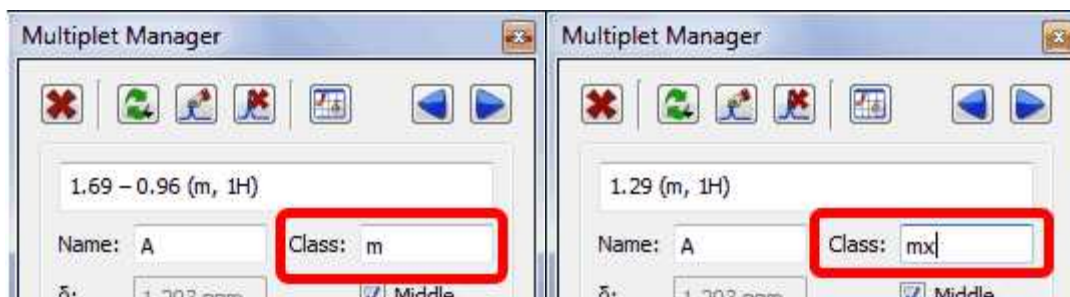



The number of hydrogens (Nuclides) will be rounded (up or down) by default with respect to the multiplet integral value (which in this case corresponds with the area under the multiplet range, not with the area under the integral curve).

Bear in mind that, integrals and multiplets are two independent lists, so you can change the nuclides (or multiplet) value, without affecting to the integration.

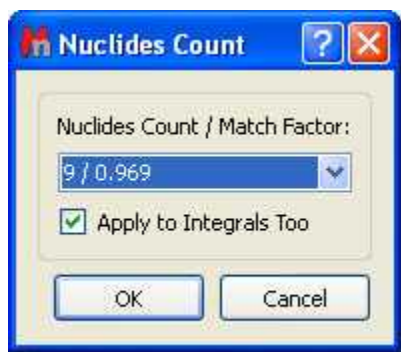

Please keep in mind that it is possible to import the integral normalization values by clicking on the applicable icon  of the 'Multiplet Manager' dialog box.

Clicking on the 'Auto' button  of the 'Multiplet Manager' dialog box will display the 'Nuclides Count dialog box'. From this window, you will be able to select the total number of nuclides of the spectrum (nine hydrogens in the example below) and apply it to the spectrum.

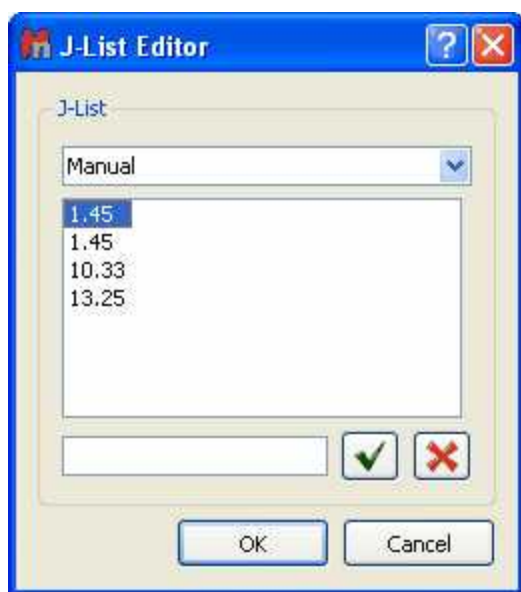

The user will also be able to add or delete couplings constant by clicking on . After that, the 'J's Editor' dialog box will be displayed:



From the multiplet manager dialog box, you can delete a multiplet by clicking on the 'Delete' button  or navigate through the multiplets by using the 'Previous' or 'Next' buttons .

From this dialog box, you can also "add multiplet peak"  (if you pick a peak twice with this feature, the peak will be removed) or delete undesired peaks  by using the applicable icons.

Once you click on this icon , you will see the applicable label above each peak of the multiplet, indicating the name of the multiplet:

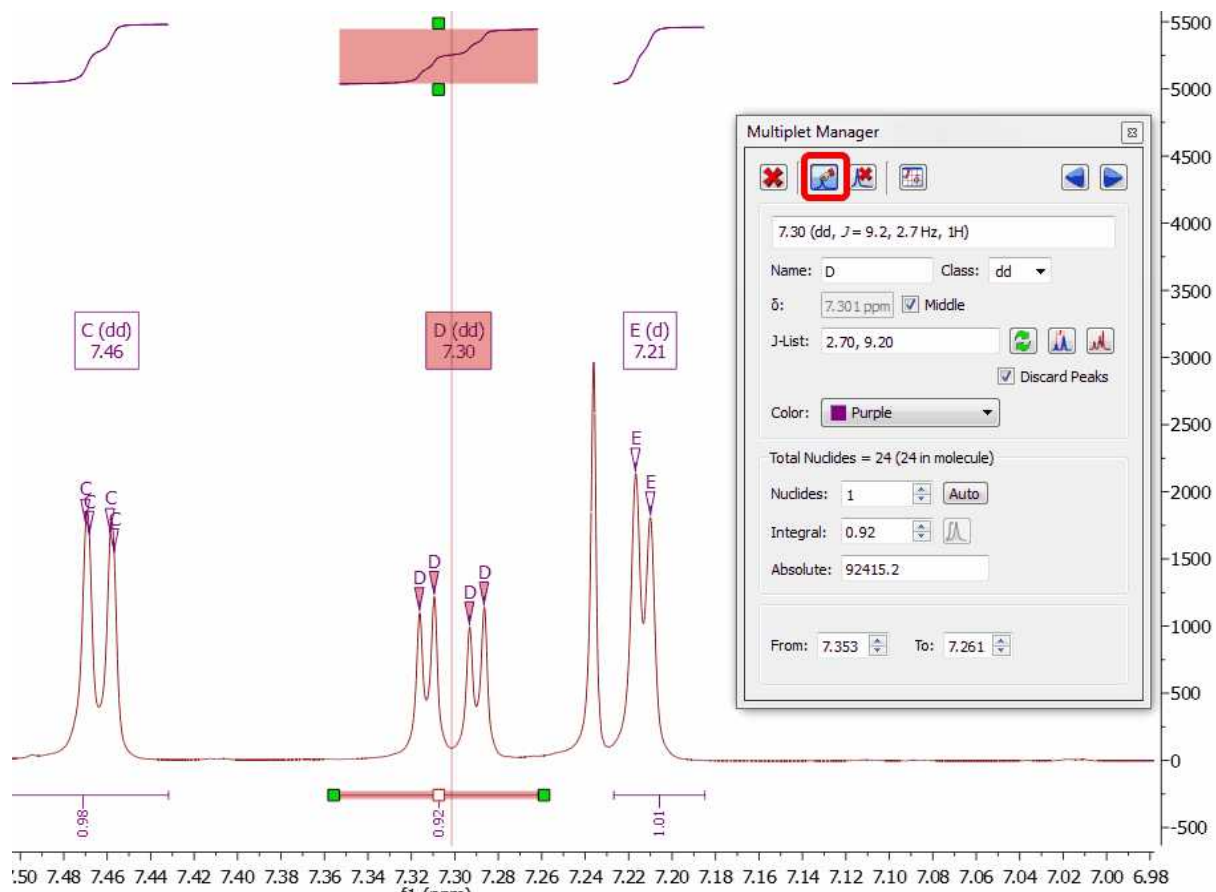

Please note that the 'Multiplet Manager' dialog is **modeless**, so you will be able to use any other tool (i.e. zooming) whilst you are applying the analysis.

Clicking on this button  will allow you to select two points in the spectrum and the difference between them in Hz will be added to the J list.

Mnova offers the possibility of displaying the corresponding synthetic multiplet built using these calculated J couplings. This is a useful tool to check whether the values calculated by Mnova using first order rules actually match the experimental multiplet. In order to show the synthetic multiplet, just check the button highlighted in red in the figure below. The program will automatically create a synthetic multiplet with a light red color as background.

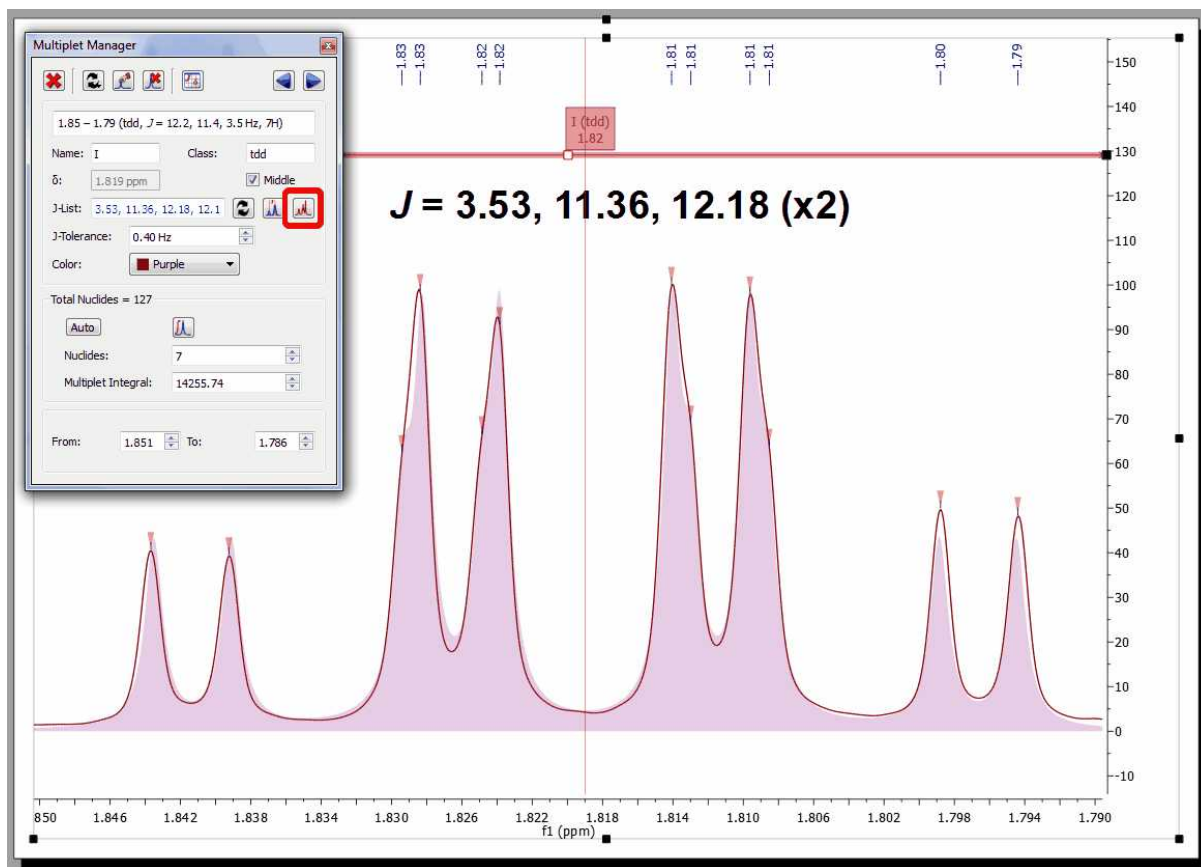

9.5.2 Using GSD for multiplets analysis

Exploiting the power of GSD for an improved Multiplet Analysis

By default Mnova uses traditional peak picking algorithms for automatic peak picking, integration and multiplet analysis. Latest enhancements introduced in Mnova make it possible to replace traditional peak picking by the more sophisticated Global Spectral Deconvolution (GSD) algorithm.

Multiplet Analysis benefit directly from the exploitation of GSD capabilities to carry out the automatic analysis, with the enhanced peak picking capabilities resulting in much more reliable automatic multiplicity identification and labeling.

Here you can see an example of a triplet which is hidden under the solvent signal:

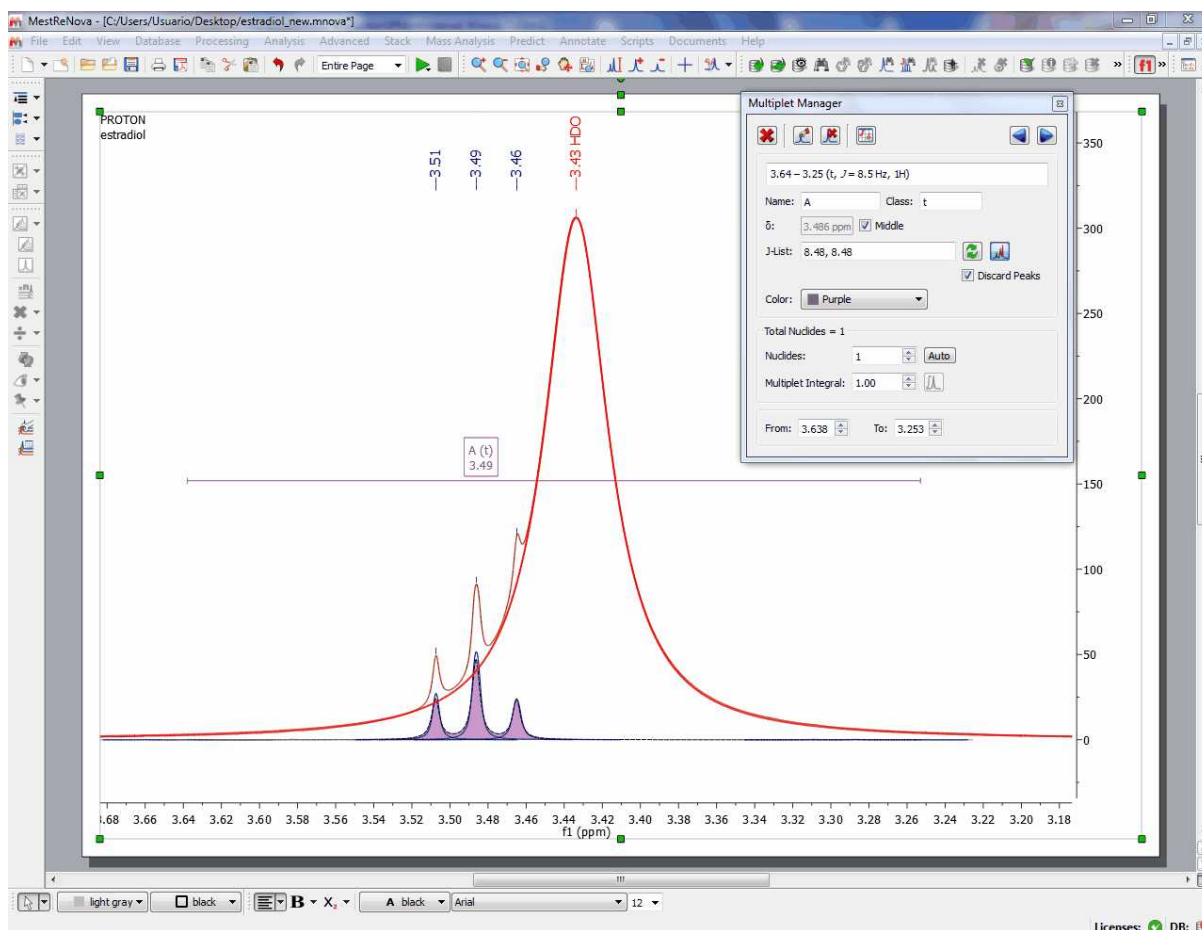

In order to use this algorithm, it is necessary to set the following options in Mnova.

1 – Defining the GSD level

GSD has different operational levels, ranging from a very fast but inaccurate method to slower but much more accurate levels. In addition, GSD makes it possible the automatic recognition of solvent peaks, impurities, etc. We recommend to use a GSD level of 1 (flash) or 2. This level can be set from GSD/Options as depicted below:



Also, make sure that the Auto Edit option is checked.

From now on Mnova will use GSD when automatic peak picking algorithm is issued.

2 – Set the Automatic Integration method to GSD

Finally, for Mnova to be able to detect the multiplets regions (integrals) automatically using GSD, it's necessary to define this method in the integration options.

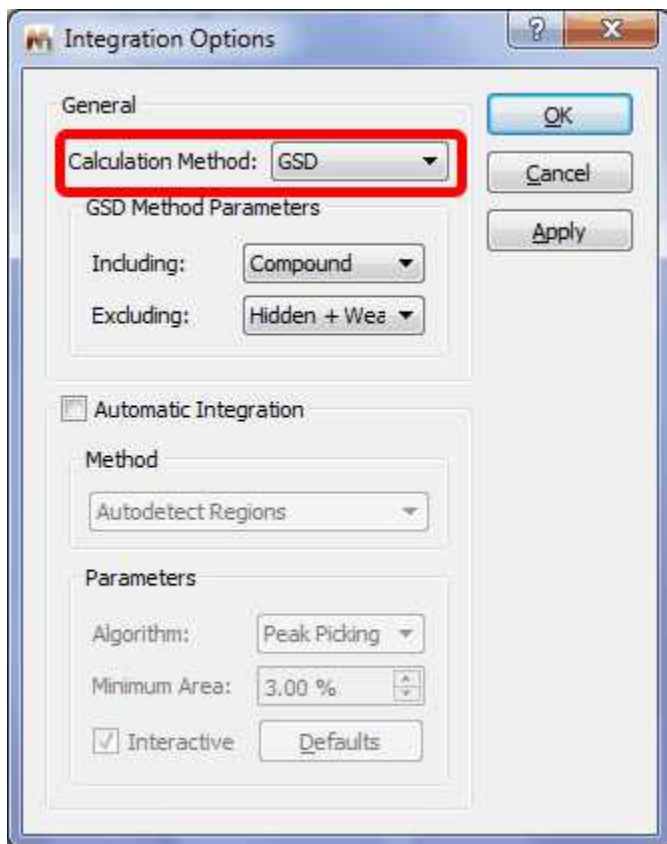

First Order Multiplet Analysis with GSD with Resolution Enhancement

(click [here](#) to download the spectrum used chapter)

Consider the following multiplet:

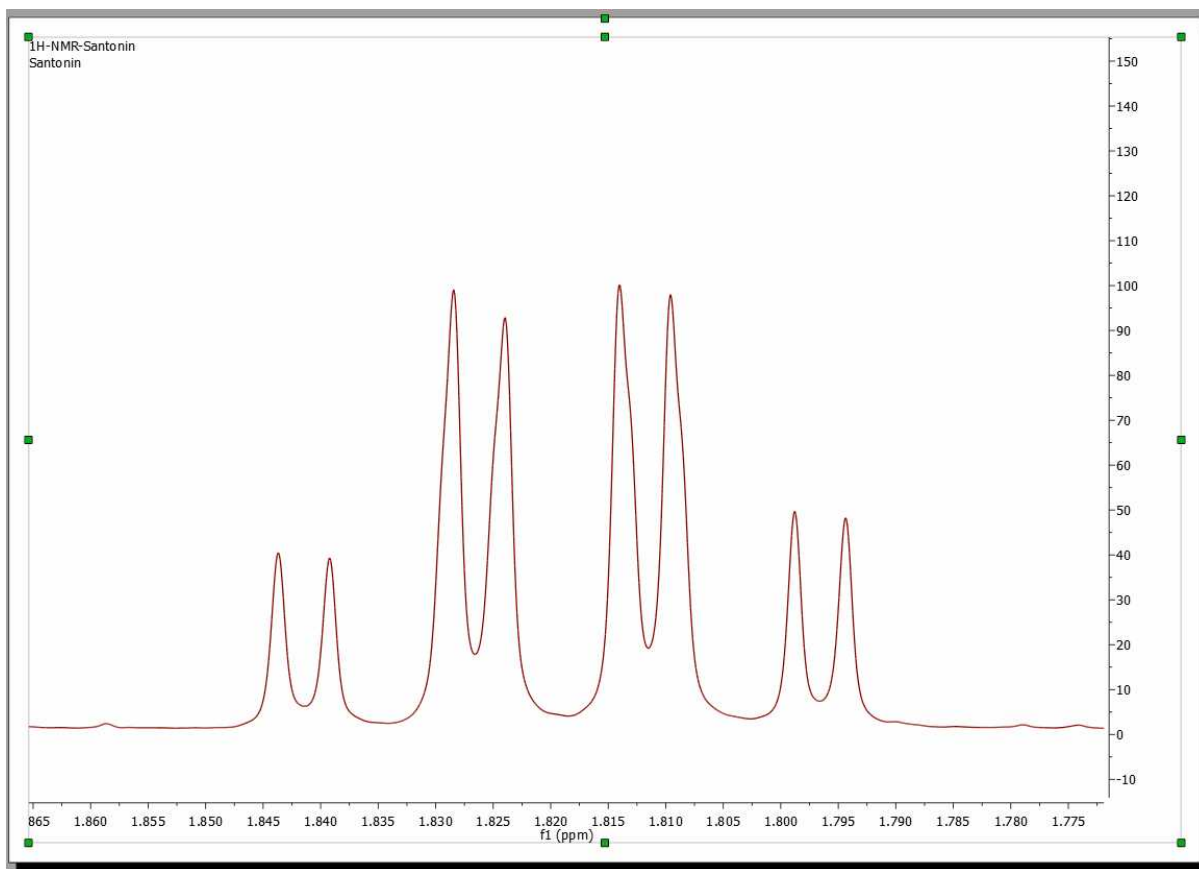

At first sight, this looks like a doublet quadruplet ($J = 12.2 \times 3, 3.6$ Hz) and in fact, this is what some NMR software packages would report if this multiplet were analyzed using based on traditional peak picking algorithms.

Now Mnova Multiplet Analysis is armed with GSD, making the analysis of NMR spectra a more efficient process. Assuming that all Mnova options have been set properly in order to use GSD for multiplet analysis, this is what Mnova would report for this multiplet:

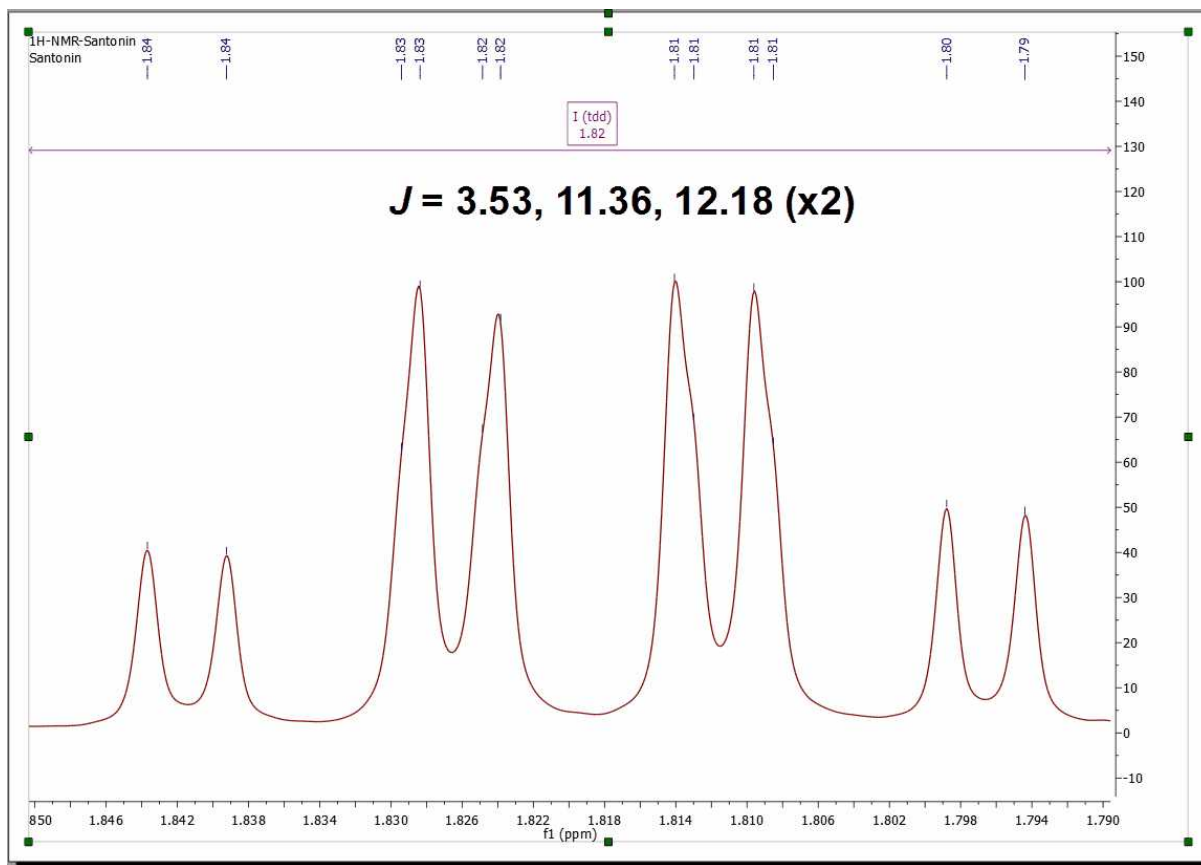

As it can be noticed, Mnova now finds an extra coupling of 11.4 Hz. If we take a closer look at the fine structure of the multiplet once GSD has been applied, we can observe that the 4 peaks in the center of the multiplet are actually split into 8 peaks as illustrated in the figure below:

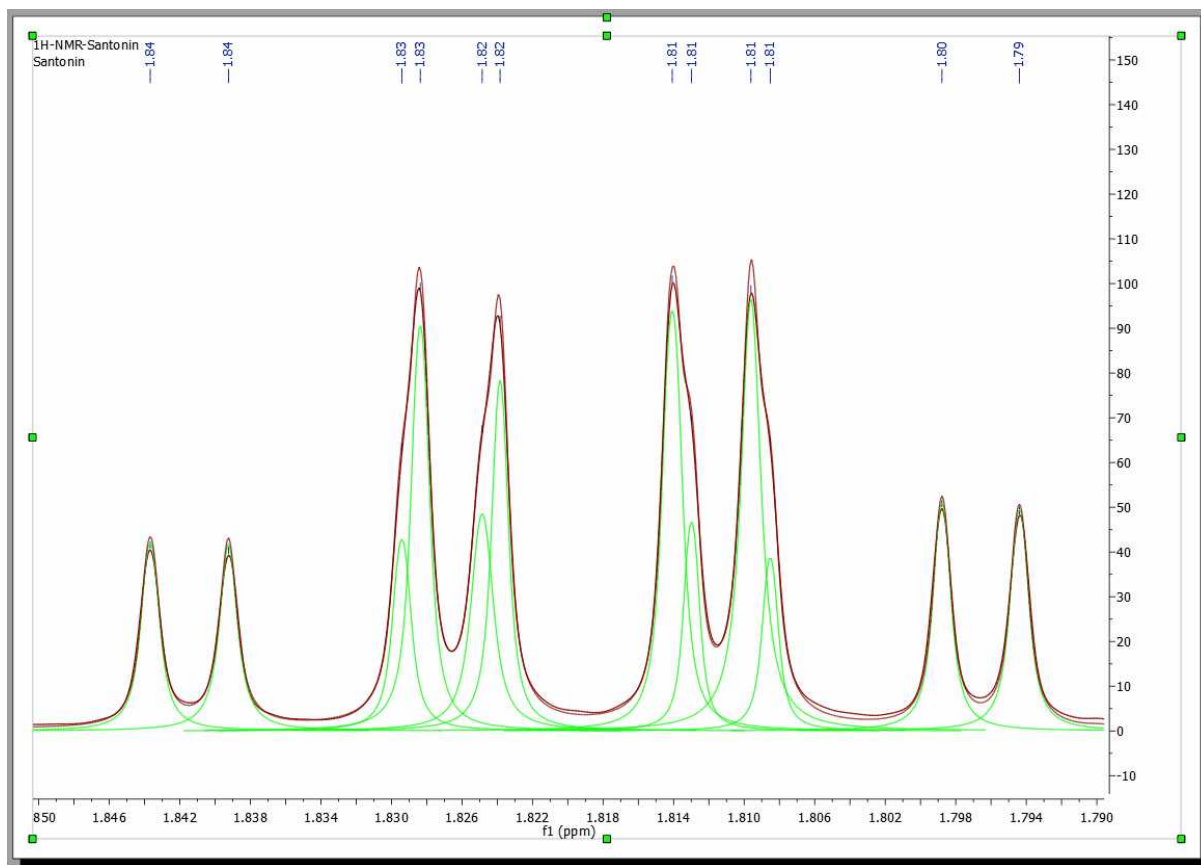

9.5.3 Setting multiplets

Setting multiplets with Mnova is very easy and intuitive. All the multiplet boxes are mouse-sensitive and they respond to usual mouse operations. If you want to move up or down all the multiplet boxes, just click and drag (with the left mouse button) over anyone of the boxes (notice that hovering the mouse over the box will highlight it in red).

To change the range of the multiplets, hover the mouse over the multiplet box, click on one of the green squares and drag the mouse to the left or right (notice that once you hover the mouse over the green squares of the multiplet label, the mouse pointer turns to horizontal arrow).

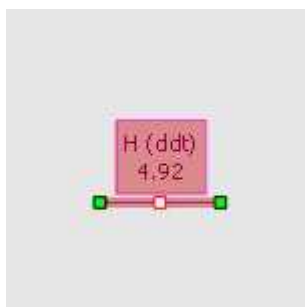

Cutting Multiplets: It is possible to divide any multiplet just by clicking on the red square of the

multiplet label and dragging the mouse as you can see in the picture below:

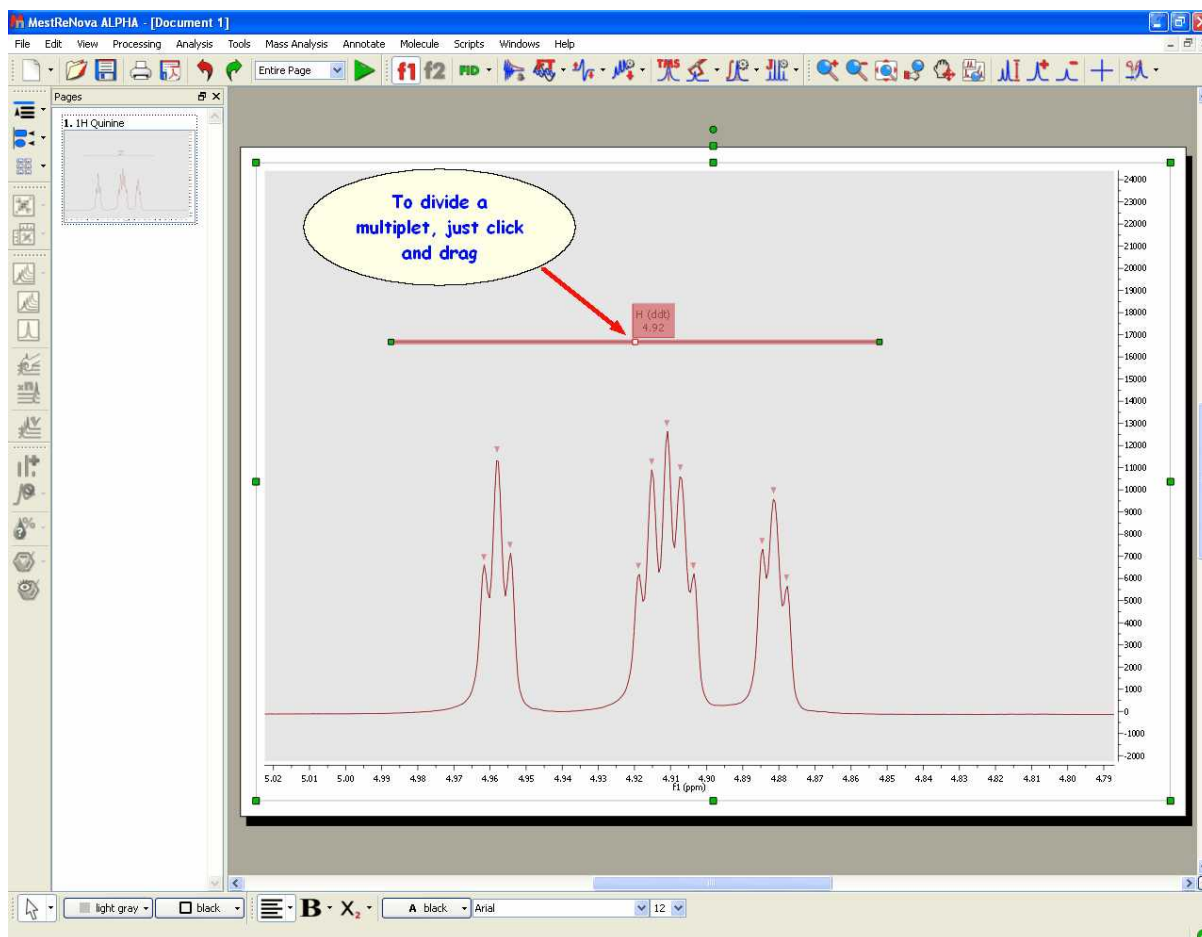

Right clicking on the multiplet box, will display the applicable context menu:

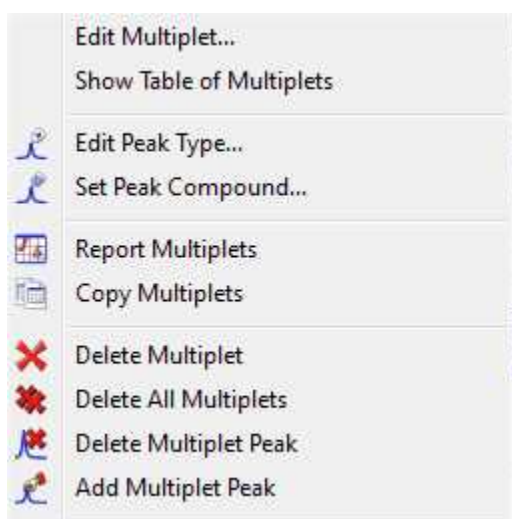

From here you will be able to display the 'Multiplet Manager' or the 'Table of Multiplets'. You can also change the 'Peaks Type' (from compound to impurity, solvent, artifact, etc) or to assign the peaks inside the multiplet to a specific compound. It will be also possible to generate a 'multiplet report', copy

the multiplets to the clipboard, delete and add multiplet peaks, etc as you can see in the picture above.

9.5.4 How to resolve overlapped multiplets?

It is really easy to resolve overlapped multiplets. Imagine the below overlapped doublets:

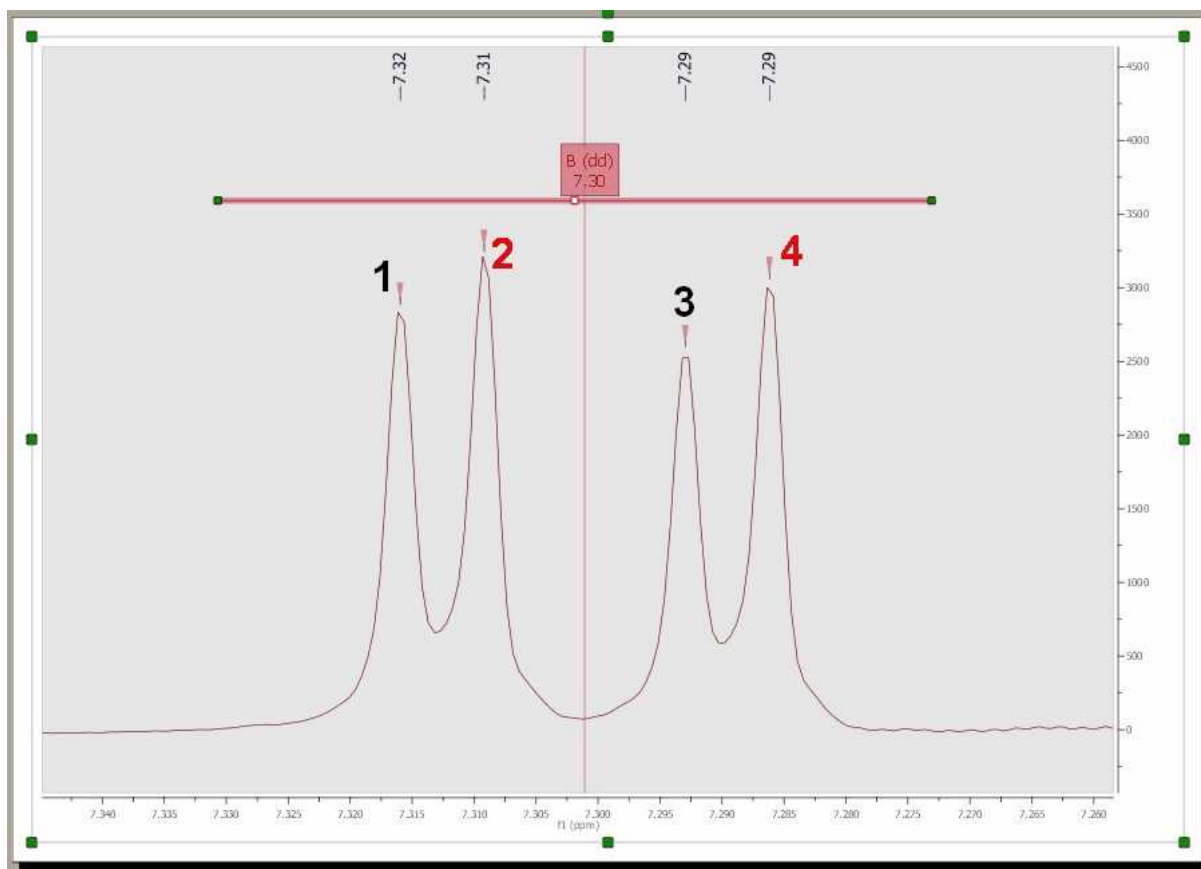

where the peaks 1 and 3 correspond to one doublet and the other peaks (2 and 4) to the second doublet. First of all, divide the multiplet just by clicking on the red square of the multiplet label (to obtain two overlapped multiplets):

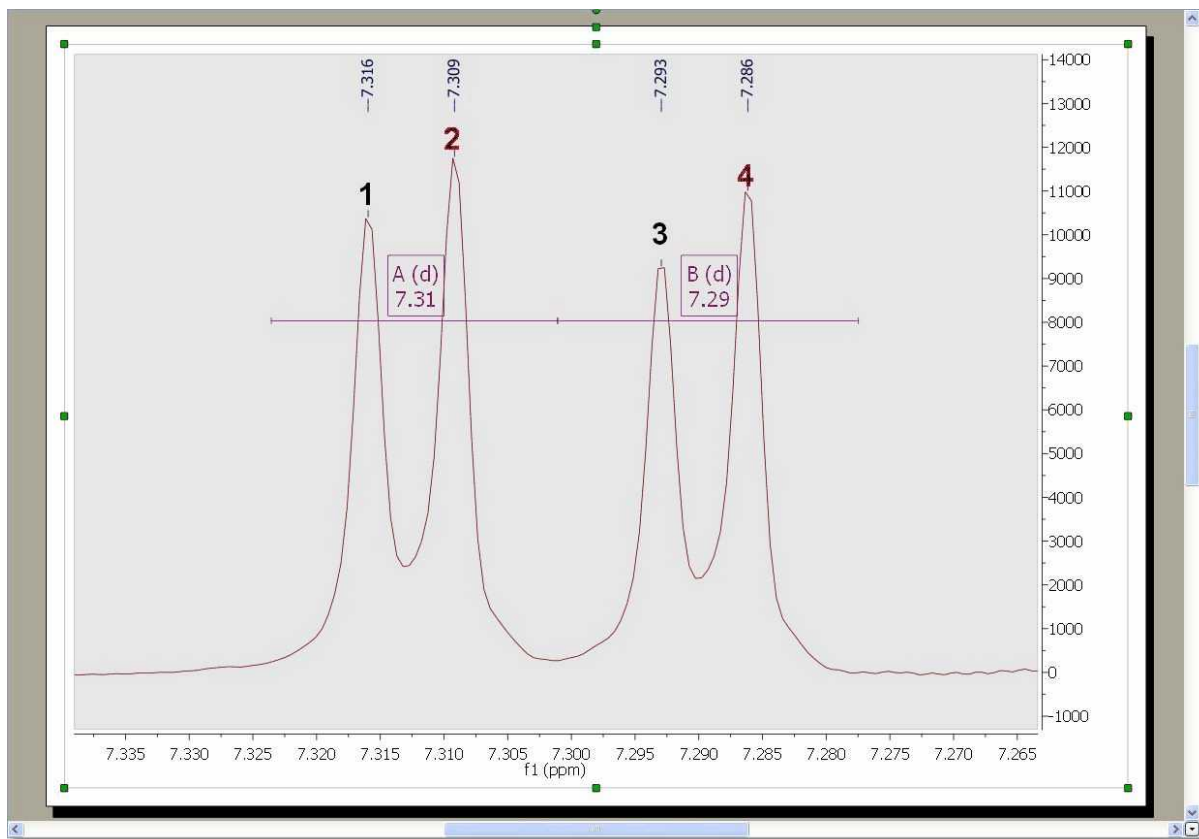

Next, double click on any of the multiplet boxes to launch the 'Multiplet Manager' dialog box. Once there, click on the 'Add multiplet peak' button (red square in the picture below). With this tool you can also remove peaks from the multiplet, by picking over a previously picked peak. It will also possible to delete undesired peaks by using this button .

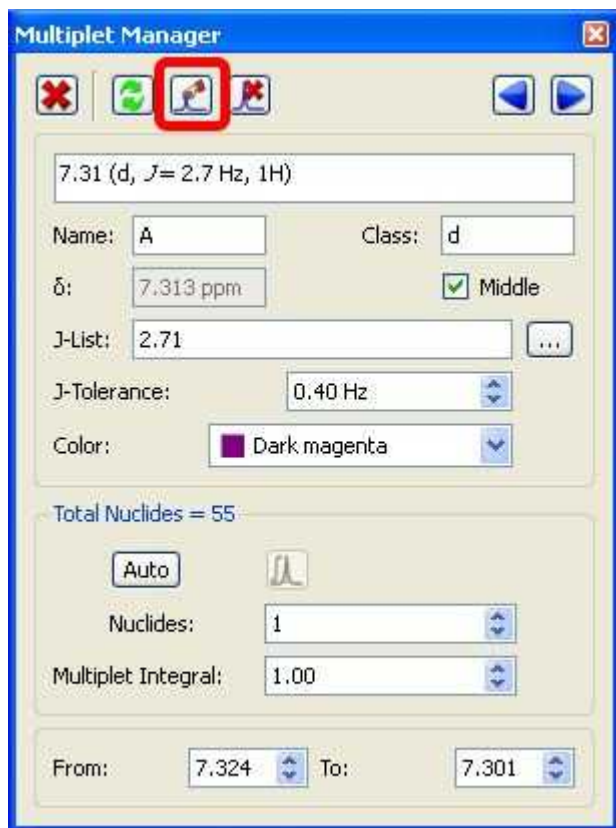

This will add a peak label with the multiplet name (A and B) over each peak, as you can see below:

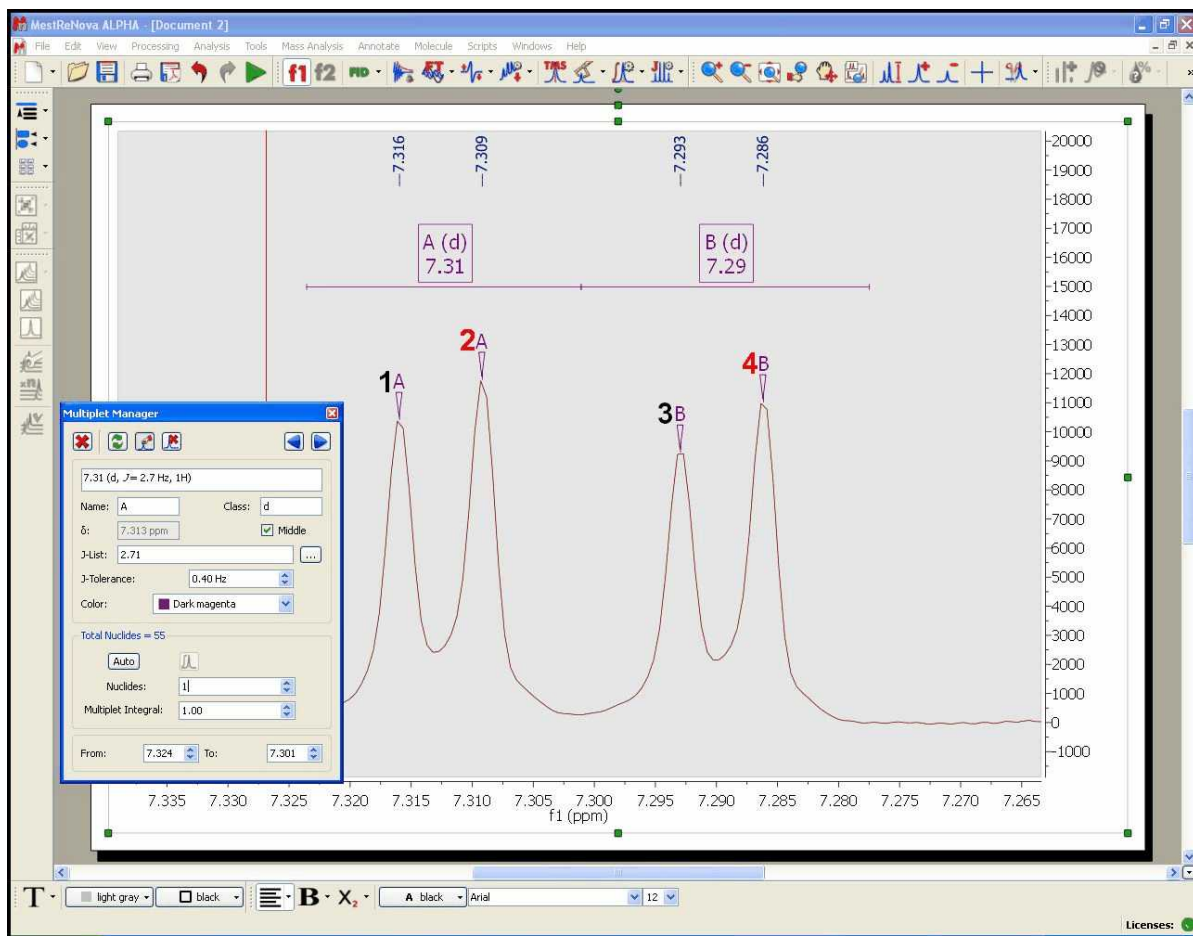

Finally, hover the mouse over the multiplet box A, click and drag to the the label (**B**) of the peak 3, or vice versa, hover the mouse over the label of the peak 3, click and drag it to the multiplet box A (as it is shown in the picture below):

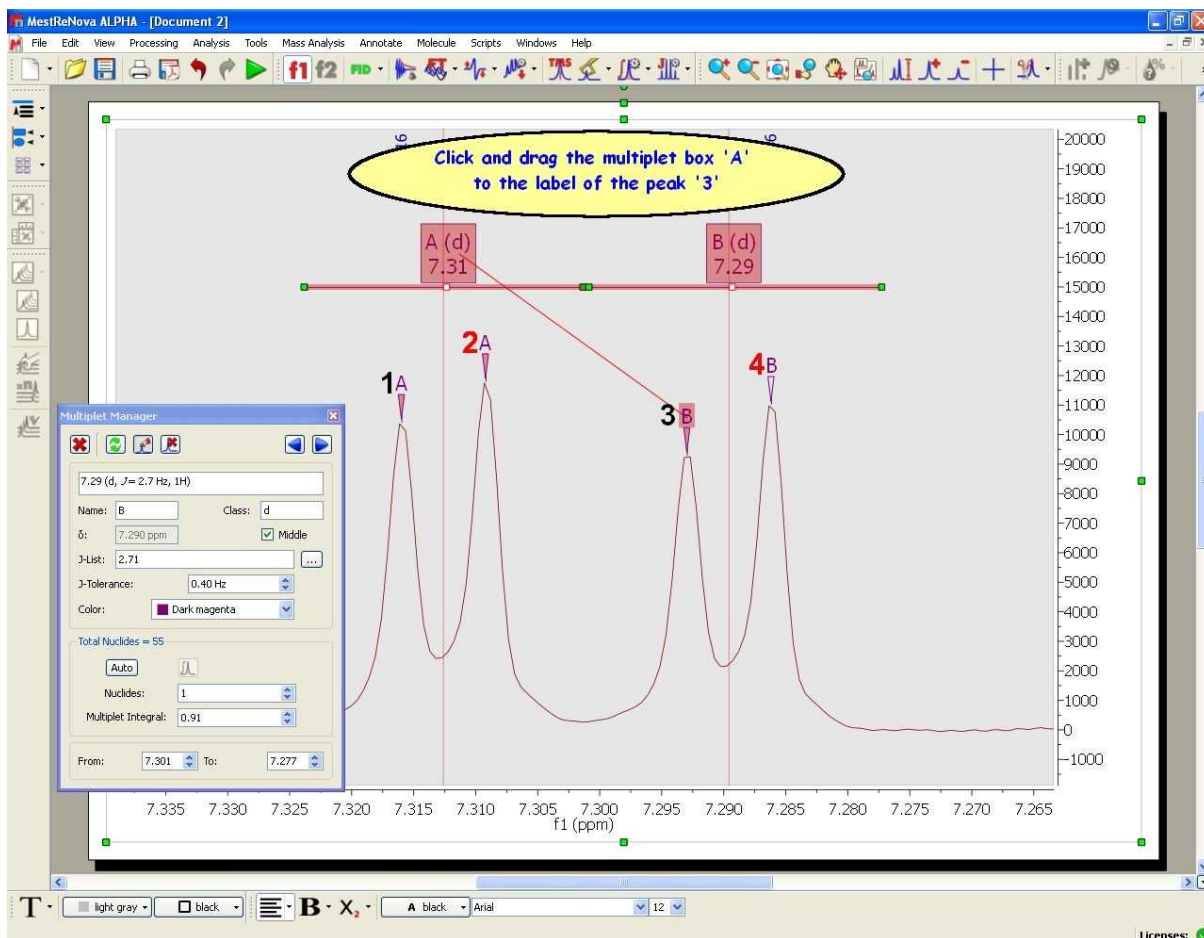

After that, the peak 3 will be a part of the multiplet A; (at this moment the multiplet A contains the peaks 1, 2 and 3):

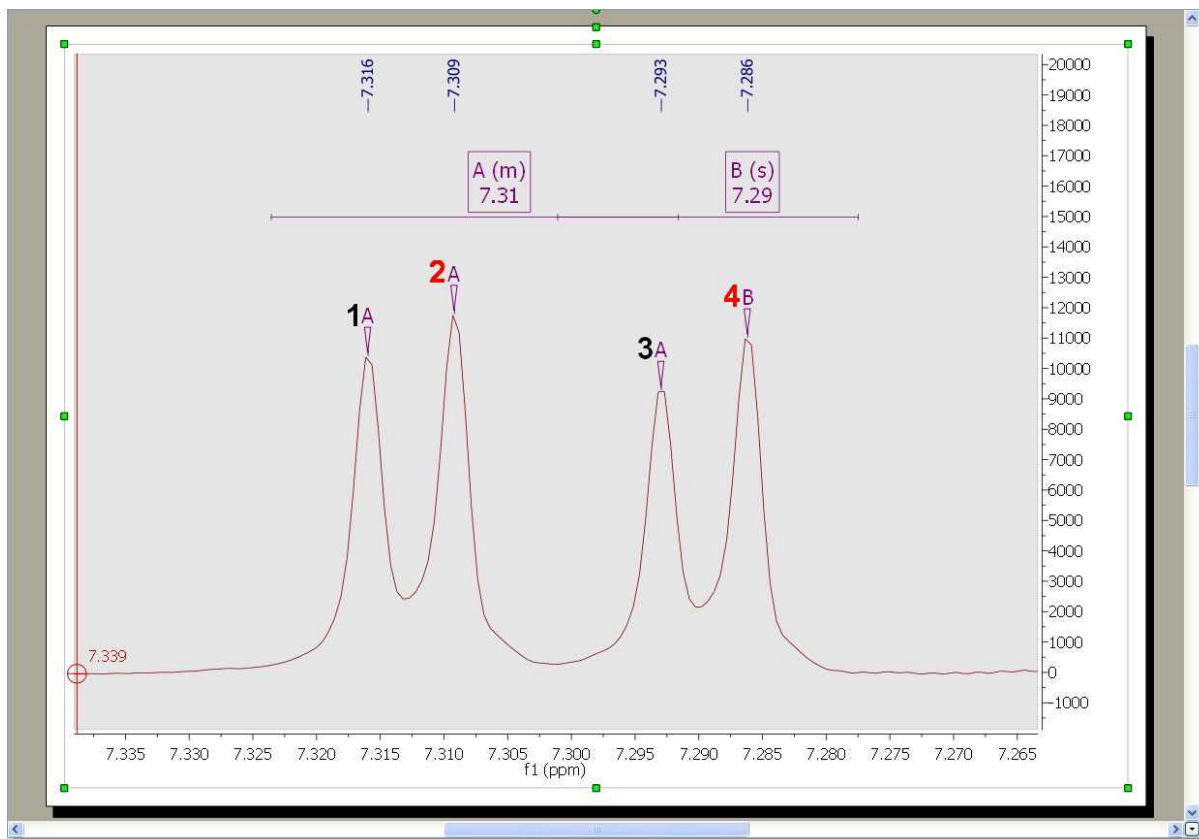

Finally, do the same procedure with the peak 2 and the multiplet box **B** (click and drag the peak label to the multiplet box or vice versa), in order to include the peak 2 into the multiplet B:

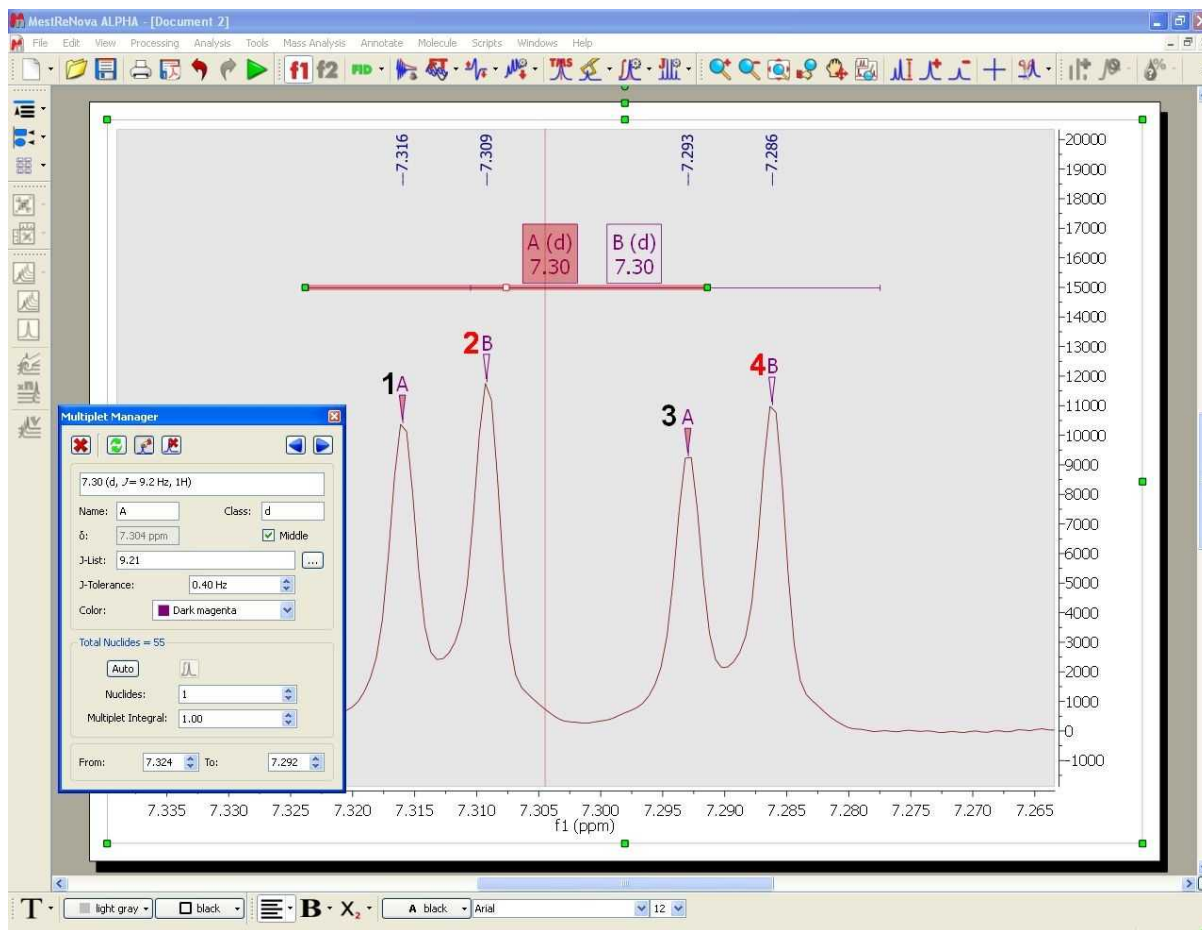

As you can see in the picture above the multiplet A contains the peaks 1 and 3 and the multiplet B contains the peaks 2 and 4.

9.5.5 Multiplets Table and Reports

Multiplets Table

The user will be able to get the 'Multiplets' table by following the menu 'View/Tables'. The 'Multiplets' table includes information about the name (by default Mnova will have named the multiplets in alphabetical order, but the user is able to change this order in the 'Multiplet Manager'), the chemical shift (ppm), the range (ppm), number of hydrogens, integral value, type of multiplet and coupling constant values (Hz).



Multiplets

Report Multiplets Copy Multiplets Setup Report Delete

¹H NMR (400 MHz, CDCl₃) δ 8.62 (d, *J* = 4.4 Hz, 1H), 7.95 (d, *J* = 9.4 Hz, 1H), 7.46 (d, *J* = 4.5 Hz, 1H), 7.30 (dd, *J* = 9.3, 2.7 Hz, 1H), 7.21 (d, *J* = 2.7 Hz, 1H), 5.73 (ddd, *J* = 17.5, 10.3, 7.6 Hz, 1H), 5.48 (d, *J* = 4.3 Hz, 1H), 4.99 – 4.84 (m, 2H), 3.87 (s, 3H), 3.38 (dddd, *J* = 13.4, 10.5, 5.6, 2.5 Hz, 2H), 3.17 – 2.99 (m, 2H), 2.63 (dddt, *J* = 10.7, 6.0, 4.3, 2.0 Hz, 2H), 2.30 – 2.18 (m, 1H), 1.83 – 1.62 (m, 3H), 1.61 – 1.34 (m, 2H).

	Name	Shift	Range	H's	Integral	Absolute	Class	J's
1	C (d)	7.46	7.51 .. 7.43	1	0.86	92585.19	d	4.51
2	A (d)	8.62	8.67 .. 8.58	1	0.80	86101.39	d	4.39
3	N (m)	1.71	1.83 .. 1.62	3	3.29	352791.56	m	
4	M (m)	2.24	2.30 .. 2.18	1	0.96	103210.06	m	
5	L (dddt)	2.63	2.69 .. 2.55	2	1.97	211502.68	dddt	2.01, 2.01, 4.29, 6.03, 10.73
6	K (m)	3.09	3.17 .. 2.99	2	2.31	247987.14	m	
7	J (dddd)	3.38	3.46 .. 3.31	2	1.90	203318.84	dddd	2.54, 5.56, 10.50, 13.36
8	I (s)	3.87	3.90 .. 3.85	3	3.08	330582.25	s	

You can add/remove columns by selecting 'Setup table' in the Setup Report scroll down menu.

The user can paste the 'Multiplets' table on the spectrum by clicking on the **'Report table'** option  (under the 'Report Multiplets' scroll down menu) and also can delete a multiplet from this table by using the **'Delete'** icon  when the undesired multiplet is highlighted.

Finally, the user will be able to obtain the multiplet report list by clicking on the **'Report Multiplets'** button:

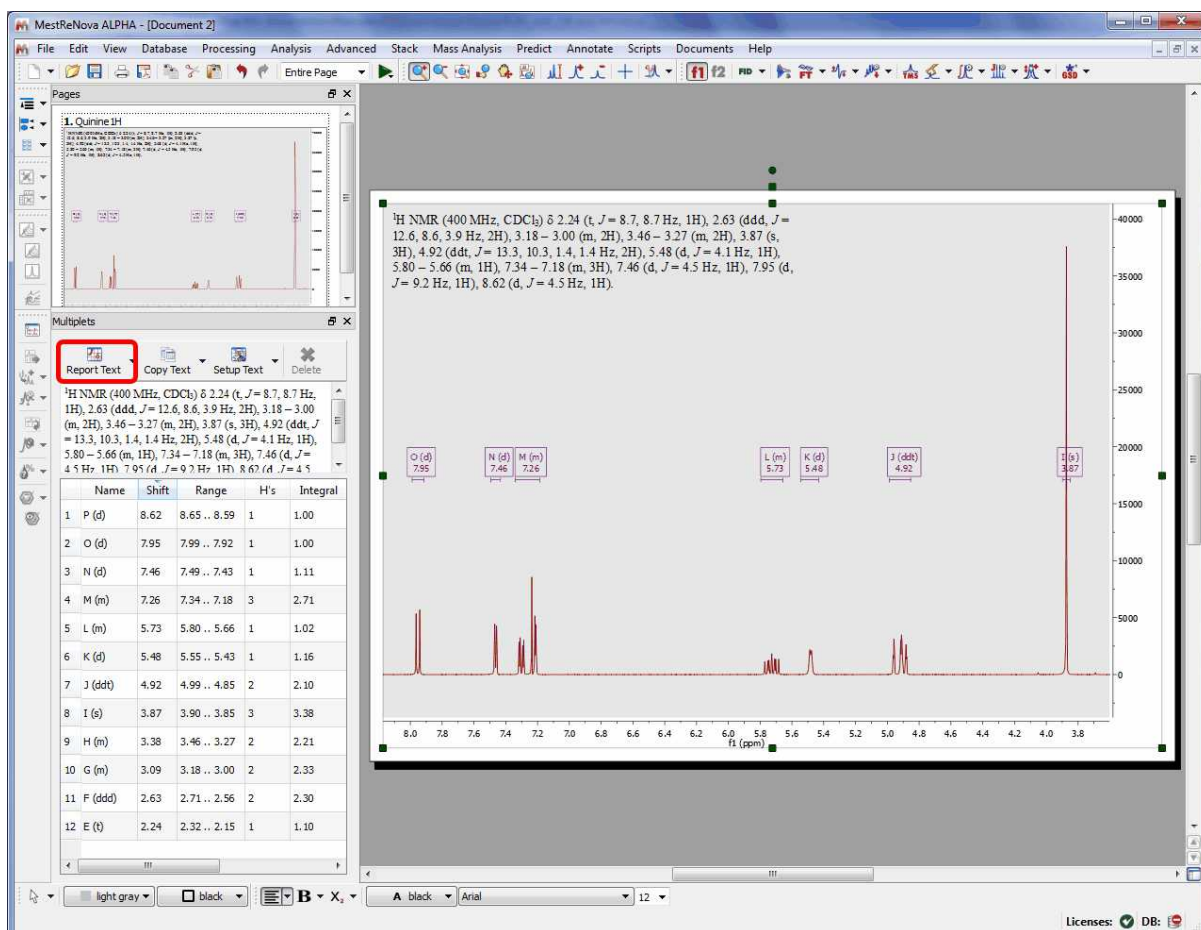

The same result will be obtained by right clicking on the multiplet box and selecting 'Report Multiplets' or by selecting 'Report Multiplets' in the 'Multiplet Analysis' scroll down menu (highlighted in red in the picture below). Of course, the user will be able to add an icon for this feature (highlighted in green in the picture below) into the toolbar. See the chapter ['Toolbars Customization'](#) for further information about it.

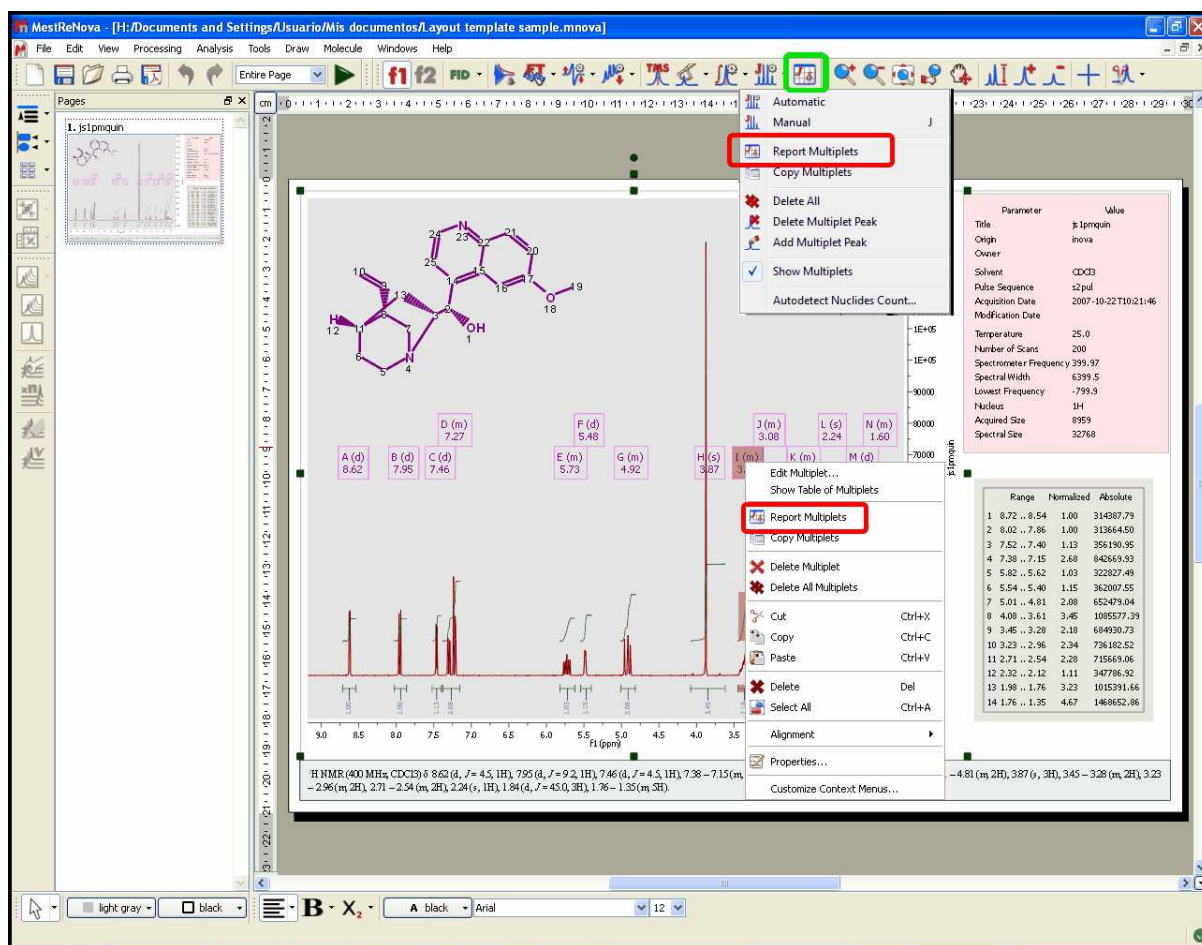

How can I select the Journal template for my multiplet reports?

The format of the Multiplet Report can be selected just by selecting 'Setup' (in the 'Setup Text' scroll down menu of the Multiplet Table). This will display the 'Multiplet Report' dialog box with a scroll down menu, which will allow the user to select the desired template (JACS, Royal Society of Chemistry, Angewandte or any other Custom Report).

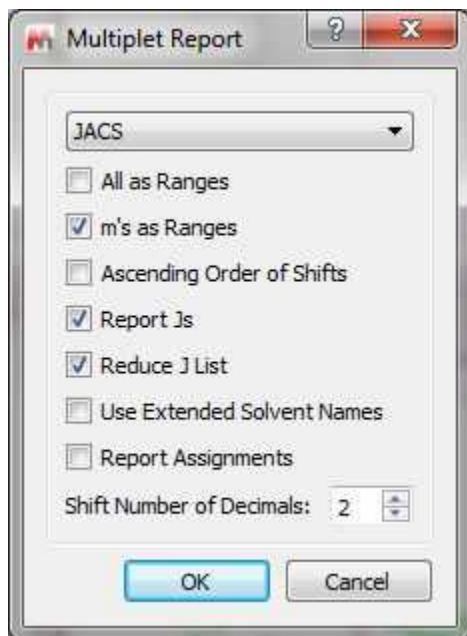

From here you can also report your multiplets as ranges or even combine the report of the multiplets (some as ranges and other as chemical shifts). To do that, please rename the class of the multiplet (from the multiplet manager dialog box) as 'mx' (being x any letter) and this specific multiplet will be reported as a chemical shift instead of the multiplet range.

It is also possible to show all degenerated coupling constants: if uncheck the option 'Reduce J List' to show all the J values.

You can also sort the multiplets in ascending order, report assignments, or use extended solvent names just by checking the applicable boxes. You can also select the number of decimals for the chemical shift values.

The user will be able to copy the multiplet report to the clipboard by selecting 'Copy Text' on the Multiplets table:

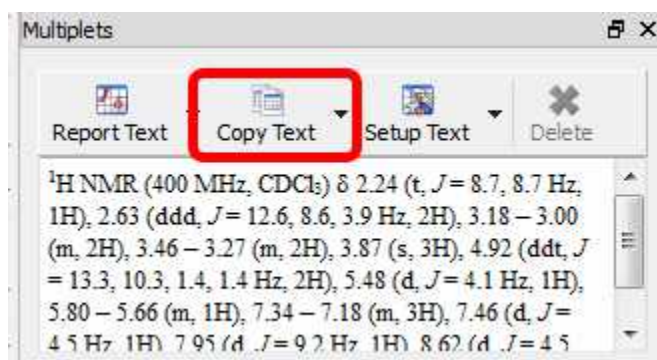

And then paste the multiplet report on another document just by using Ctrl+V or Cmd+V.

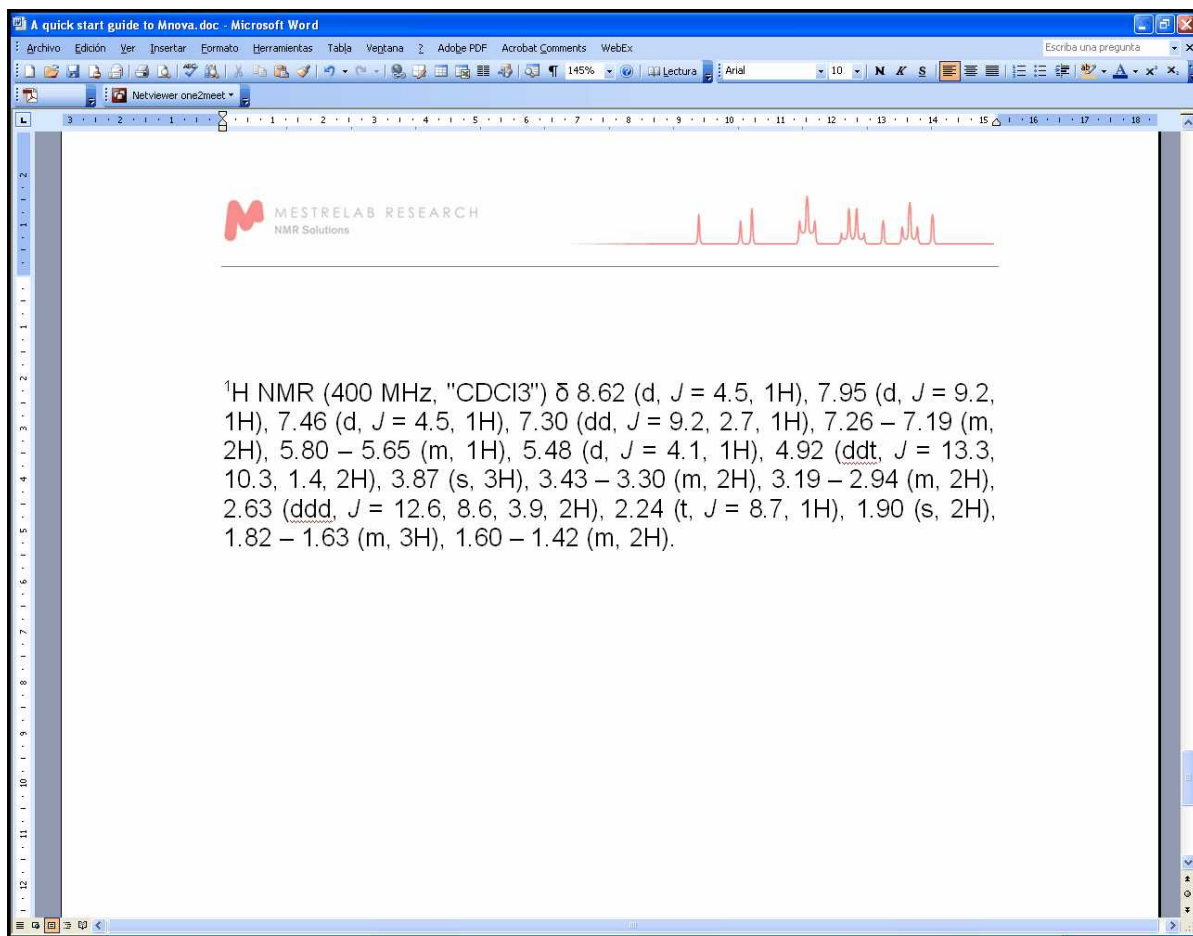

How can I create a new 'Multiplet Report' format?

The user will be able to change or create his own multiplet report templates; by following the menu 'Script/Edit Script'.

From Mnova 5.3.2, it will be possible to easily add new multiplet scripts to the Mnova interface (multiplet menus for example). This enhancement in the script feature will make the handle of the scripts easier for the user. It will be easier to share your scripts with another users and with this new feature it will be possible to add new possibilities in the future.

You can see below how to add a new multiplet reporter to the Mnova GUI.

1. Follow the menu 'Script/Edit Script' to launch the 'Script editor'.

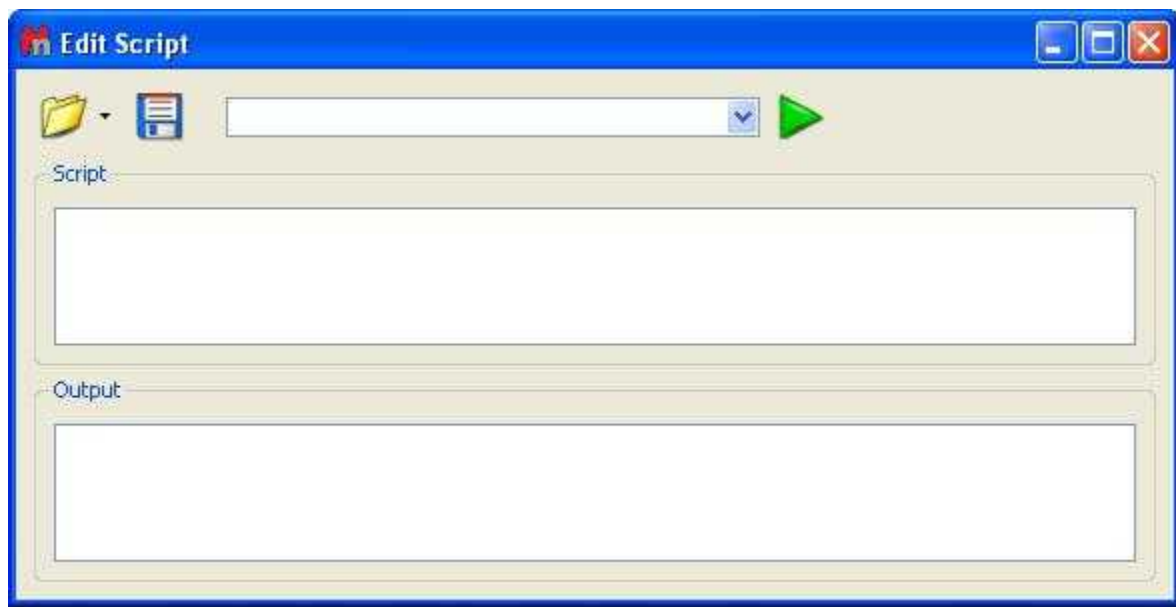

2. Write your own script or edit the example 'customMultipletReporter.qs' under the script folder of Mnova (Mnova\examples\scripts). Do not forget to include the below sentence in the script; in order to add the reporter to the program:

```
Env.MultipletReportersArray.push(new MyMultipletReporter());
```

We have created a variable in the scripts which saves a list of the known reporters. To see the list, just type in the editor:
`print(Env.MultipletReportersArray)`



See below how to edit this script.

```

var MyMultipletReporterSettingsKey = new String("MyMultipletReporter/Custom Message");

/* This creates a Custom Multiplet Reporter */
function MyMultipletReporter()
{
    MultipletReporter.call(this);

    var setts=new Settings(Application.mainWindow.scriptHandler.settings);
    this.customMessage = setts.value( MyMultipletReporterSettingsKey, "My Journal" );

    this.name = "My Custom Multiplet Reporter";

    this.onlyElementName=false;
    // Define font size and font family
    this.font = "<font style='{font-size: 10pt; font-family: Times New Roman}'>";

    this.nucleusTemplate="%1";
    // Report header. %1 will be replaced with nucleusString, %2 with frequency, %3 with solvent.
    this.header = this.customMessage+" %1 NMR (%2 MHz, %3) &delta; ";
    //this.header = "Custom %1 NMR (%2 MHz, %3) &delta; ";

    // Multiplet templates. %1 - delta, %2 - category, %3 - nH
    this.reportRange = true; // set to true to get multiplet range instead of delta.
    this.withoutJsTemplate = " %1 (%2, %3H)"; // multiplet template without J's
    this.withJsTemplate = " %1 (%2, %4, %3H)"; // multiplet template with J's
    this.rangeTemplate = "%1 &ndash; %2";

    // J's list template. %1 - list of J's
    this.jListTemplate = "<i>J</i> = %1";

    this.jPrecision = 1; // J's precision
    this.deltaPrecision = 2; // delta precision
    this.mSeparator = ", "; // multiplet separator
    this.jSeparator = ", "; // J's separator

    this.start = "<html><head><title>Multiplet Report</title></head><body>" + this.font;
    this.end = "</font></body></html>";
}

MyMultipletReporter.prototype = new MultipletReporter();
MyMultipletReporter.prototype.toString = function() { return "MyMultipletReporter()"; };

//This line adds my custom reporter to the list of reporters, this means that this reporter can be used by the general functions like
reportMultipletsUser or automaticMultipletReport and it can be used to generate reports from the Multiplets Table
Env.MultipletReportersArray.push(new MyMultipletReporter());

//Uncomment this line to make this reporter the default reporter, the saved settings will be ignored, the user will not be able to modify the
reporter from MNova
//Env.DefaultMultipletReporter = "My Multiplet Reporter";

```

3. Save the resulting script (for example 'My Multiplet Reporter') in a directory where Mnova will be able to find it and restart Mnova. To add new script directories follow the menu 'Edit/Preferences/Scripts/Directories':

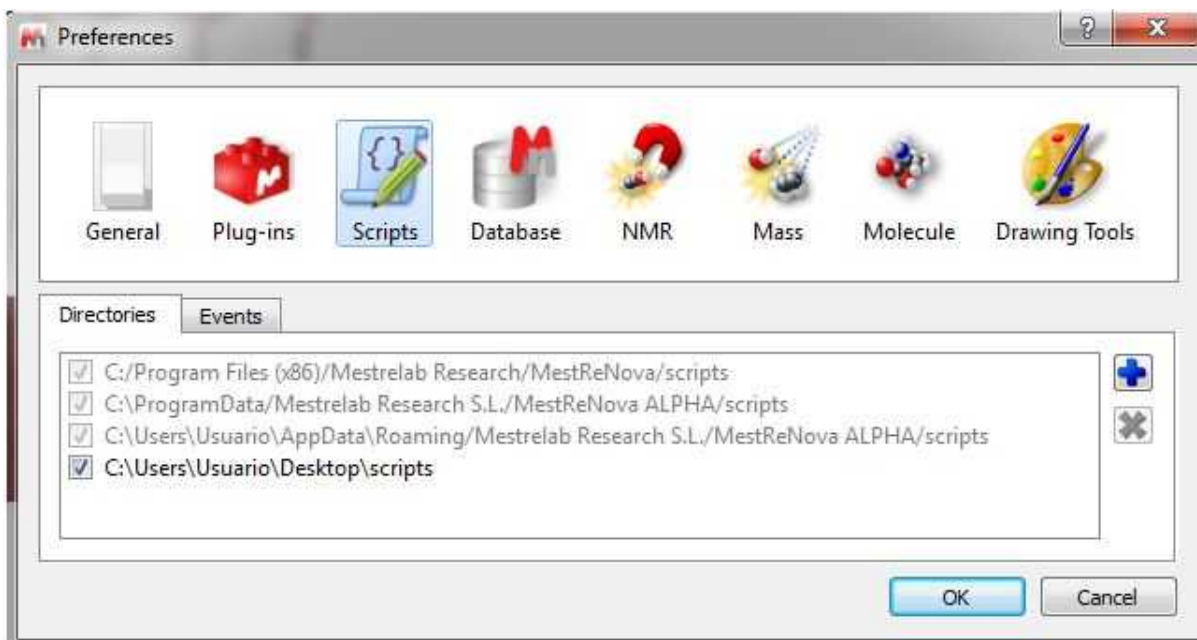

4. The script will be automatically added to the Mnova GUI (for example, to the 'Multiplet Table/Report Special/Setup' menu). This will allow you to select the 'Multiplet Report' format for your analysis. Of course, you can add as many different scripts as you need.



Please bear in mind that the multiplet format that you select on this dialog box, will be applied always when you select the 'Multiplet Report' option; however you can select any other formats for individual reports (without changing the default one) just by following the menu 'Scripts/Report/Multiplets' and selecting the desired format for that report.

Let's see how to create a new multiplet reporter script from the example 'customMultipletReporter.qs' (stored at the 'example/scripts' folder of Mnova) :

```

/*****
*****
Copyright (C) 2009 Mestrelab Research S.L. All rights reserved.
This file is part of the MNOVA scripting toolkit.

```

```

Authorized users of MNova Software may use this file freely, but this file is provided AS
IS
with NO WARRANTY OF ANY KIND, INCLUDING THE WARRANTY OF DESIGN, MERCHANTABILITY AND FITNESS
FOR A PARTICULAR PURPOSE.
*****
*****/

var MyMultipletReporterSettingsKey = new String("MyMultipletReporter/Custom Message");

/* This creates a Custom Multiplet Reporter */
function MyMultipletReporter()
{
    MultipletReporter.call(this);

    var setts=new Settings(Application.mainWindow.scriptHandler.settings);
    this.customMessage = setts.value( MyMultipletReporterSettingsKey, "My Multiplet
Reporter" );

    this.name = "My Multiplet Reporter";

    this.onlyElementName=false;
// Define font size and font family
    this.font = "<font style=\"font-size: 10pt; font-family: Times New Roman\">";

    this.nucleusTemplate="%1";
// Report header. %1 will be replaced with nucleusString, %2 with frequency, %3 with
solvent
    this.header = this.customMessage+" %1 NMR (%2 MHz, %3) &delta; ";
    //this.header = "Custom %1 NMR (%2 MHz, %3) &delta; ";

// Multiplet templates. %1 - delta, %2 - category, %3 - nH
    this.reportRange = true; // set to true to get multiplet range instead of delta.
    this.withoutJsTemplate = " %1 (%2, %3H)"; // multiplet template without J's
    this.withJsTemplate = " %1 (%2, %4, %3H)"; // multiplet template with J's
    this.rangeTemplate = "%1 &ndash; %2";

// J's list template. %1 - list of J's
    this.jListTemplate = "<i>J</i> = %1";

    this.jPrecision = 1; // J's precision
    this.deltaPrecision = 2; // delta precision
    this.mSeparator = ", "; // multiplet separator
    this.jSeparator = ", "; // J's separator

    this.start = "<html><head><title>Multiplet Report</title></head><body>" + this.font;
    this.end = ".</font></body></html>";
}

MyMultipletReporter.prototype = new MultipletReporter();
MyMultipletReporter.prototype.toString = function() { return "MyMultipletReporter()"; }

//This line adds my custom reporter to the list of reporters, this means that this reporter
can be used by the general functions like reportMultipletsUser or automaticMultipletReport
and it can be used to generate reports from the Multiplets Table
Env.MultipletReportersArray.push(new MyMultipletReporter());

//Uncomment this line to make this reporter the default reporter, the saved settings will
be ignored, the user will not be able to modify the reporter from MNova
//Env.DefaultMultipletReporter = "My Multiplet Reporter";

//This function can be used to generate multiplet reports
function customReportMultipletsUser(createItem)
{
    var multipletTable = new MultipletTable(nmr.multipletTable()); // Get table of
multiplets
    var spectrum;
    if(multipletTable.isValid())
        spectrum = new NMRspectrum(multipletTable.spectrum()); // Get spectrum
currently shown in the table of multiplets
    else
        spectrum = new NMRspectrum(nmr.activeSpectrum());
}

```

```

    if( spectrum.isValid() )
    {
        var reporter = MultipletReporter.getReporterByName("My Multiplet Reporter");
        return reporter.report(spectrum, createItem);
    }
    else
        return undefined;
}

//Uncomment this line to use the previous function to report multiplets instead of the
default one
//Env.ReportMultipletsUser = customReportMultipletsUser;

//Function to setup my reporter
function customReportMultipletsUserSetup()
{
    var rep = MultipletReporter.getReporterByName("My Multiplet Reporter");

    var diag = new Dialog();
    diag.title = "Custom Setup";

    var lEdit = new LineEdit();
    lEdit.text = rep.customMessage;
    diag.add(lEdit);

    if(diag.exec())
    {
        rep.customMessage = lEdit.text;
        settings.setValue( MyMultipletReporterSettingsKey, rep.customMessage );
    }
}

//Uncomment this line to use the previous function to setup the report multiplets
//Env.ReportMultipletsUserSetup = customReportMultipletsUserSetup;

```

Firstly, we are going to change the name of the 'Multiplet Reporter' and the message which appears at the beginning of the Multiplet Report (customMessage) to 'My Report' and 'My Journal' respectively' (see the text below highlighted in yellow)

```

/* This creates a Custom Multiplet Reporter */
function MyMultipletReporter()
{
    MultipletReporter.call(this);

    var setts=new Settings(Application.mainWindow
.scriptHandler.settings);
    this.customMessage = setts.value( MyMultipletReporterSettingsKey,
    "My Journal" );

    this.name = "My Report";

    this.onlyElementName=false;
}

```

`this.onlyElementName=false`; changing false with true, we will obtain only the element name without the atomic mass (For example: H, C instead of ¹H, ¹³C).

The function: `this.font = "`; will define the font size and the font family of the multiplet report.

We are going to change the font of the multiplet report to 14pt and Arial:

```

// Define font size and font family
    this.font = "<font style=\"font-size: 14pt; font-family: Arial\">"
;

```

The line: `this.header = this.customMessage+ "%1 NMR (%2 MHz, %3) δ ";` is used to print the header of the report, where %1 will be the nucleus (H or C), %2 the frequency of the spectrometer (in MHz), and %3 the solvent, followed by a delta symbol (δ). For example: ^1H NMR (500 MHz, CDCl_3)

Let's modify the header of the report by putting the 'delta' symbol in italic:

```
// Report header. %1 will be replaced with nucleusString, %2 with
frequency, %3 with solvent
this.header = this.customMessage+ " %1 NMR (%2 MHz, %3)
<i>&delta;</i> ";
```

We can also modify the way to report the multiplet information

```
// Multiplet templates. %1 - delta, %2 - category, %3 - nH
this.reportRange = true; // set to true to get multiplet range
instead of delta.
this.withoutJsTemplate = " %1 (%2, %3H)"; // multiplet template
without J's
this.withJsTemplate = " %1 (%2, %4, %3H)"; // multiplet template
with J's
this.rangeTemplate = "%1 &ndash; %2";
```

The sentence: `this.reportRange = true` is used to obtain the multiplet range instead of the chemical shift.

The functions: `this.withoutJsTemplate = " %1 (%2, %3H)"` and `this.withJsTemplate = " %1 (%2, %4, %3H)"` are used to customize the appearance of the multiplet report by changing the positions of %1, %2, %3H, or %4 (where, %1 means: chemical shift; %2 means: type of multiplet (s, d, t, etc); %3H means: number of hydrogens and %4 means the coupling constant value). As you can see, the first line shows a multiplet without coupling constants, (while the last line shows a multiplet with coupling constants).

So, if you need to obtain something like this (japanese format):

1H NMR (300 MHz, Solvent) δ ppm 6.43-6.22 (1 H, m), 3.17 (1 H, q, J = 7.15 Hz) etc...

You should modify both lines, as you can see below:

```
this.withoutJsTemplate = %1 (%3H, %2);
this.withJsTemplate = " %1 (%3H, %2, %4 Hz)";
```

If you prefer to obtain something like this:

1H NMR (300 MHz, Solvent) δ ppm 1.23 (d, J = 1.2 Hz, 3 H), etc...

Just replace the original lines with:

```
this.withoutJsTemplate = %1 (%2, %3H);
this.withJsTemplate = " %1 (%2, %4 Hz, %3H)";
```

You can also customize the coupling constant format:

```
// J's list template. %1 - list of J's
this.jListTemplate = "<i>J</i> = %1";

this.jPrecision = 1; // J's precision
this.deltaPrecision = 2; // delta precision
```



```

    this.mSeparator = ", "; // multiplet separator
    this.jSeparator = ", "; // J's separator

    this.start = "<html><head><title>Multiplet
Report</title></head><body>" + this.font;
    this.end = ".</font></body></html>";
}

```

To obtain the coupling constant symbol in normal instead of *'italic'*, just modify the script by removing the italic format (`<i>J</i>`). If you prefer to obtain it in **"bold"** just type:

```

    this.jListTemplate = "<b>J</b> = %1";

```

It is also possible to add a superscript to get for example: ³J:

```

    this.jListTemplate = "<sup>3</sup><i>J</i> = %1";

```

The following paragraph will be used to customize the appearance of the coupling constants list:

The second line is used for the precision of the coupling constants values, the next will be used for the precision of the chemical shift and the remaining two lines will print the separation (coma, colon, dots, etc.) between the multiplets and the coupling constants values.

If you need to obtain the coupling constants in descending order, replace **'true'** with **'false'** in the following line:

```

var jList = new JList(multiplet.jList());
jList.sort(true);

```

To obtain the multiplet range in ascending order, just replace the `rangeMin` with `rangeMax` in the below line of the script:

```

shiftStr = this.rangeTemplate.argDec(multiplet.rangeMax, 0, 'f', this.deltaPrecision).argDec(multiplet.rangeMin, 0, 'f', this.deltaPrecision);

```

It will be possible to select a multiplet report format as the default one, without allowing the user to modify it, just by removing the two slash symbols (before this sentence: `Env.DefaultMultipletReporter = "My Multiplet Reporter";`). Please bear in mind that if you do that, you will not obtain any dialog box when you follow the Menu 'Multiplets Table/Report Special/Setup'.

```

//Uncomment this line to make this reporter the default reporter, the
saved settings will be ignored, the user will not be able to modify the
reporter from MNova
Env.DefaultMultipletReporter = "My Multiplet Reporter";

```

Indeed, the variable **'Env'** contains several environment variables which can be used to customize the Mnova behaviour. Typing `print(Env)` in the Script editor, you will get the list of the available variables. In the example below, we have only defined the 'Setup' of the 'Multiplet Reports'. All the remaining variables are 'undefined'.

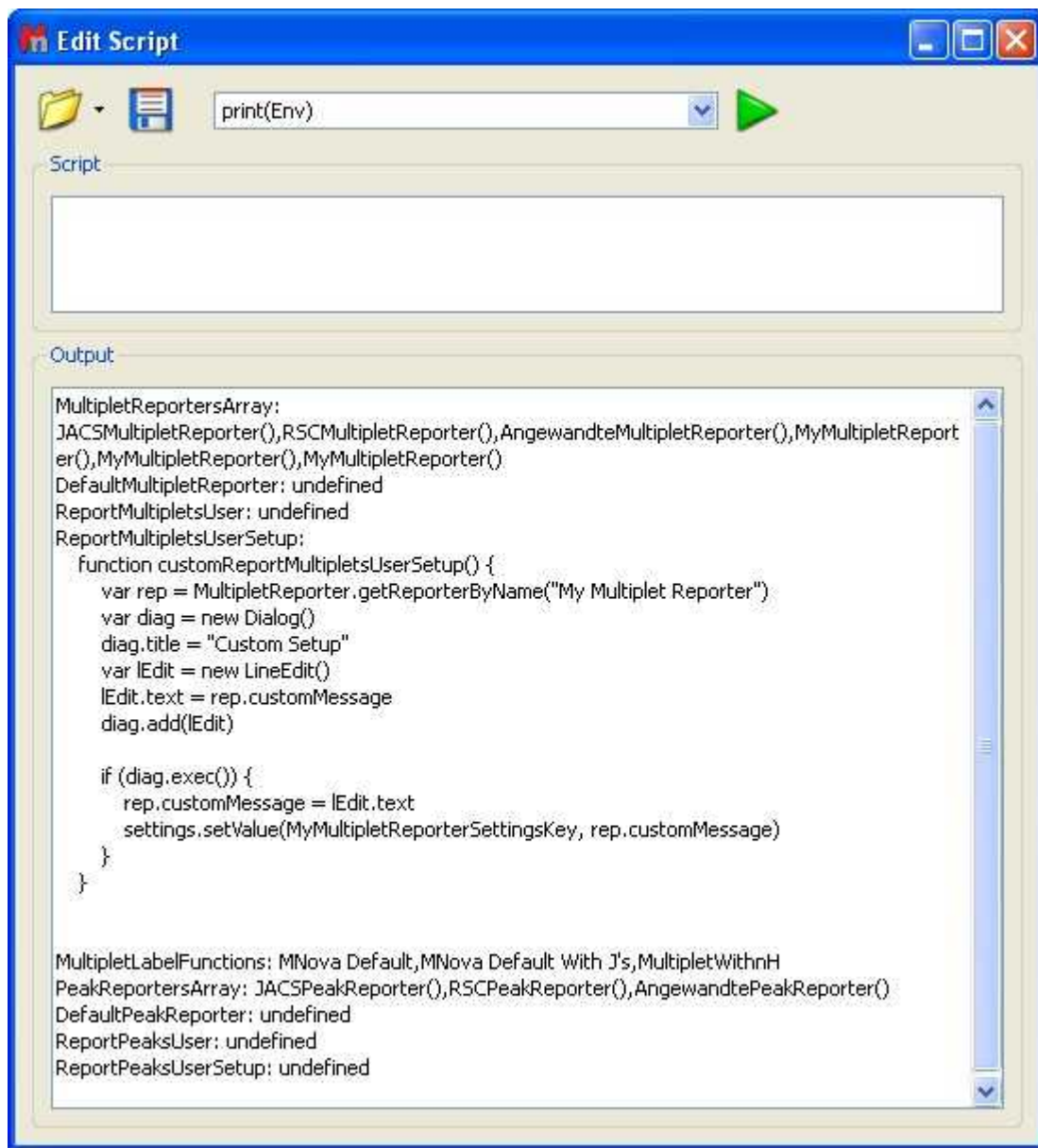

You can define the '*DefaultMultipletReport*' variable by uncomment this line in the script:

```
Env.DefaultMultipletReporter = "My Multiplet Reporter";
```

Doing that, the user will not be able to modify the multiplet report.

You can define the '*ReportMultipletUser*' variable by uncomment this line of the script:

```
Env.ReportMultipletsUser = customReportMultipletsUser;
```

Defining this variable, you will have a format for the 'multiplet report' and the 'copy special' and another different (the default one) for the report which appears on top of the 'multiplets table'.

The '*ReportMultipletUserSetup*' is the variable defined in the menu 'Multiplet Table/Report Special/Setup' for the 'Multiplet Report'.

The 'MultipletLabelFunctions' are different options (showed in the '[Multiplet Properties](#)' dialog box) which allow the user to customize the information which appears in the multiplet boxes.

9.5.6 Multiplet Analysis options

Following the menu 'Analysis/Multiplet Analysis/Options' will display the applicable dialog box:

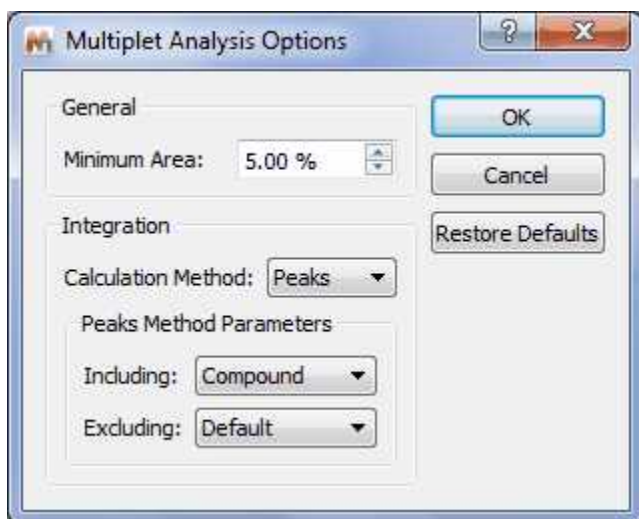

From here you can select the minimum area and the integration calculation method (Peaks, which uses GSD, or Sum, which is the classical integration method) and also to select what kind of peaks will be taken into account for the multiplet analysis. By default **only compounds peaks** will be, so the solvent peaks will not affect the multiplet analysis (very useful for example if a solvent signal overlaps with a compound peak).

9.5.7 Multiplets Properties

The user can modify the properties of the **Multiplet Analysis** by following the menu 'Edit/Properties/Multiplet Analysis' or by double clicking the left mouse (or pressing the right mouse) button on the spectrum display and selecting *Properties/Multiplets* from the *pop-up* menu.

Then, the user can choose the color, the font and the margin of the 'Multiplet' boxes.

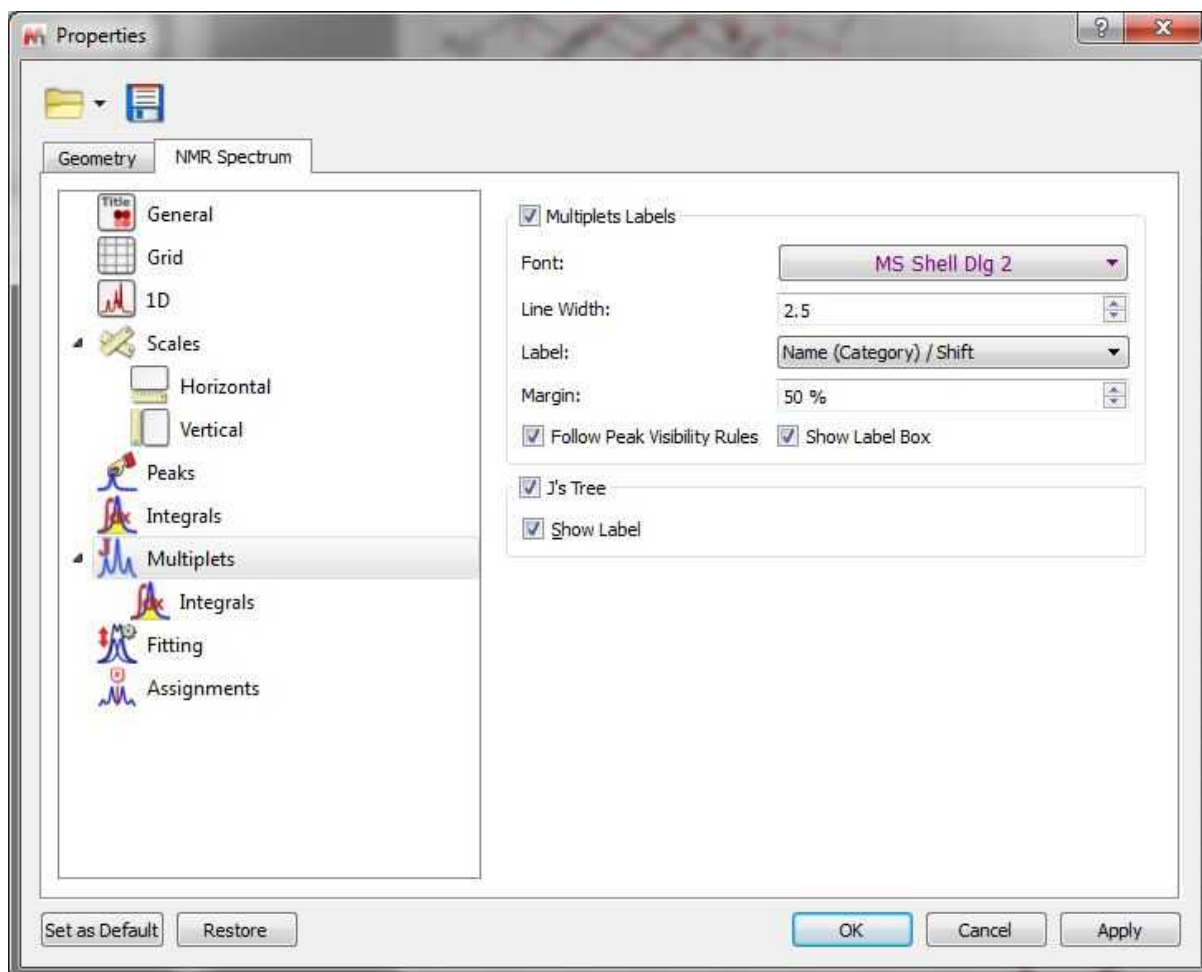

If the spectrum contains peaks belonging to more than one compound, we can show only the peaks assigned to one of them by [filtering](#) the desired peaks in the Peaks Table. Checking the 'Follow Peak Visibility rules' box will allow you to show only the multiplet boxes applicable to those visible peaks.

You can also hide the multiplet square box by unchecking the applicable box.

The user will be able to display the coupling constant tree just by checking the applicable option. Here you can see an example:

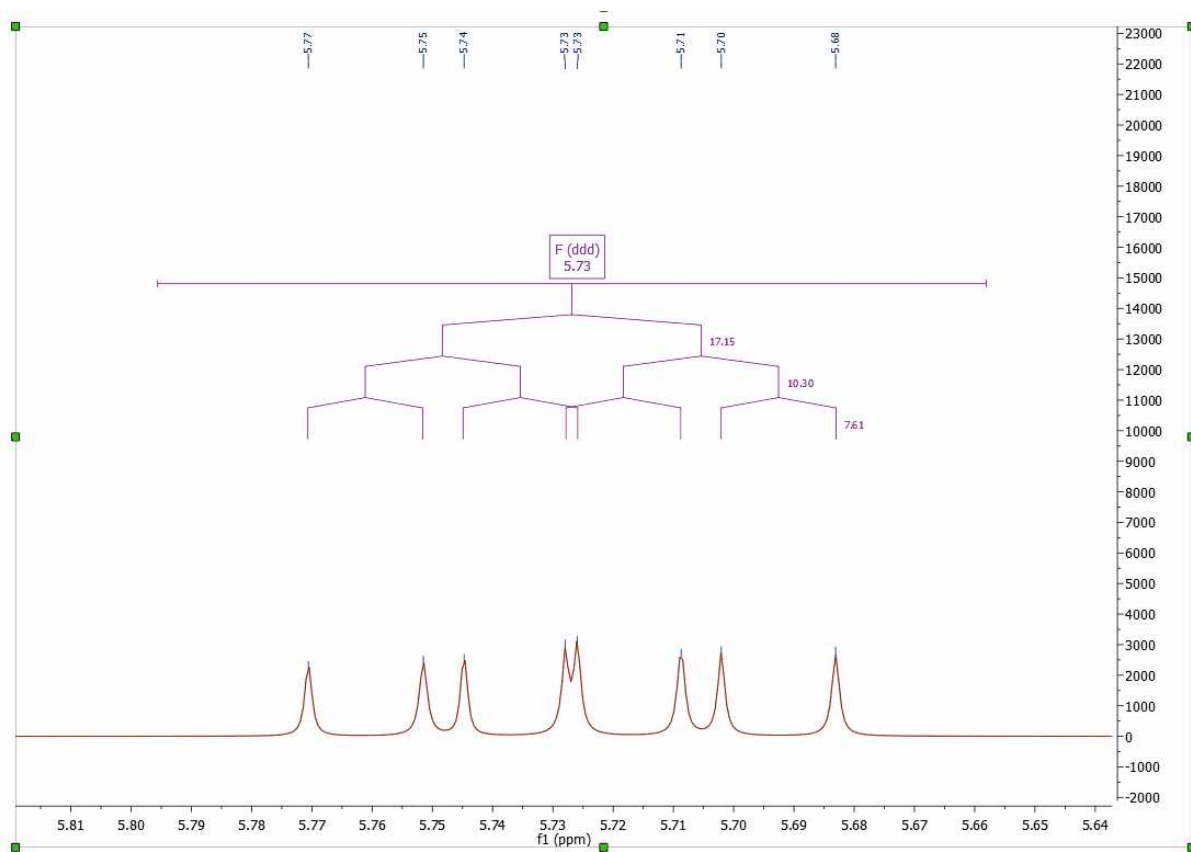

These objects are mouse sensitive in the case of predicted spectra, making possible the graphical edition of both the chemical shift and couplings by using drag & drop.

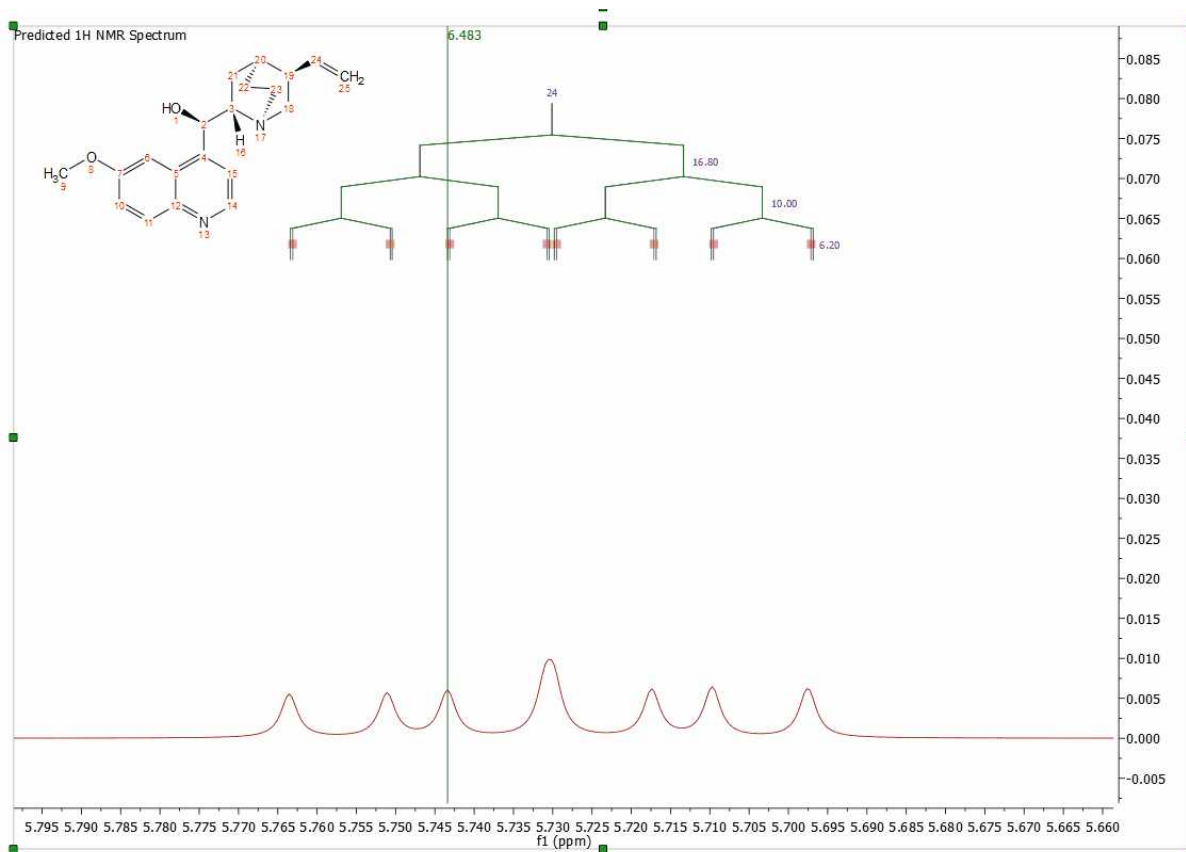

It will be possible to modify the information of the multiplet label, just by selecting the desired option in the scroll down menu:

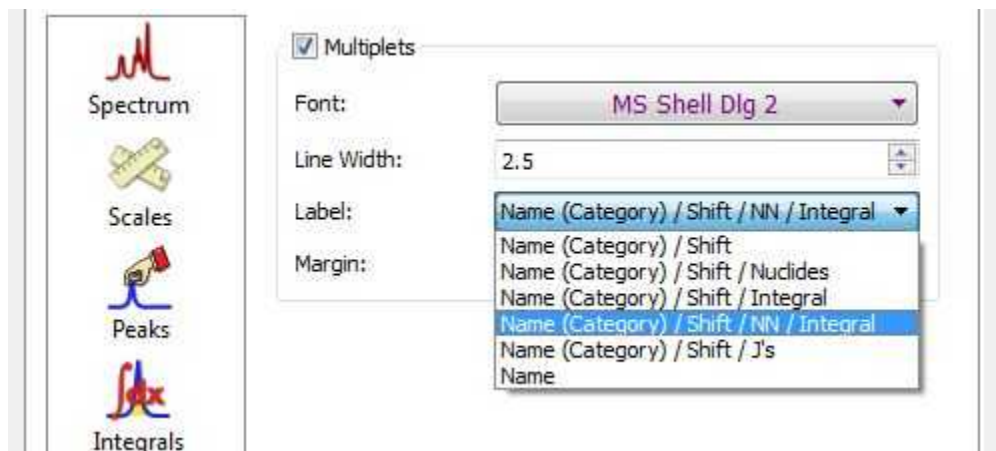

You can also add new labels by using the scripting feature. You will see below a script to show multiplet labels with the number of Hydrogens. You will find another example in the 'Examples/Scripts' folder of Mnova.

```

function customMultipletLabel()
{
  MultipletLabelReporter.call(this);
  this.name = "Multiplet Label with nH";
}
customMultipletLabel.prototype = new MultipletLabelReporter();
customMultipletLabel.prototype.report = function(aMultiplet)
{
  var multLabel = new String("%1\n%4");
  multLabel = multLabel.replace("%1", aMultiplet.name).replace("%2", aMultiplet.category).replace("%3", aMultiplet.delta.toFixed(2)).replace("%4", aMultiplet.nH);
  return multLabel;
}

Env.MultipletLabelFunctions.push( new customMultipletLabel() );

```

You will only need to save this script in a folder where Mnova can find it ('Edit/Preferences/Scripting/Scripts Directories') and after having restarted the software, you will get the new entry in the 'Multiplet Label' scroll down menu of the 'Properties' dialog box.

You can see in this [Scripts chapter](#), all the multiplet properties which you can include in the 'multiplet label'.

Adding the above script to the Mnova scripts directories, you will obtain your multiplet labels as you can see in the picture below:

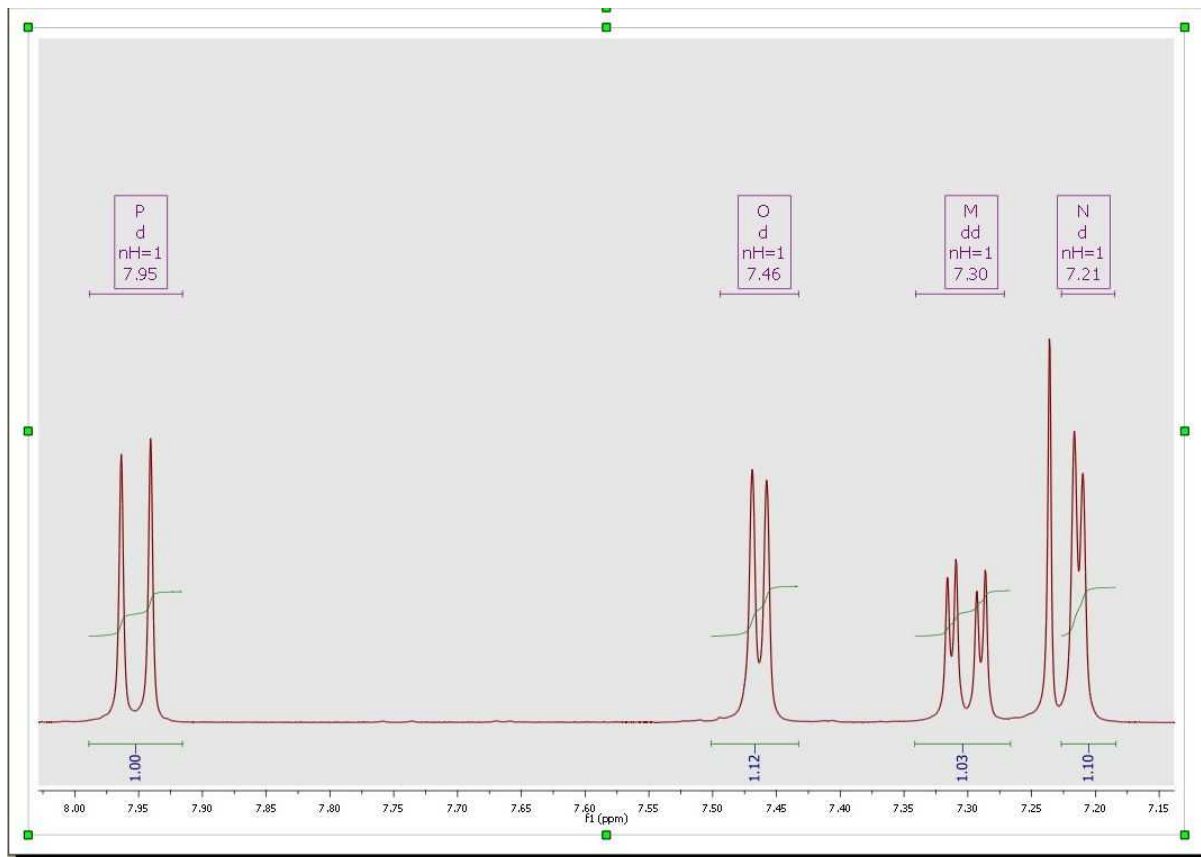

The user can also show the Multiplet Integrals Curves and customize the appearance. Please bear in mind that integrals and multiplets are two different list, so you can select what integrals you want to show (the 'pure integrals' or the integrals existing under the multiplet ranges):

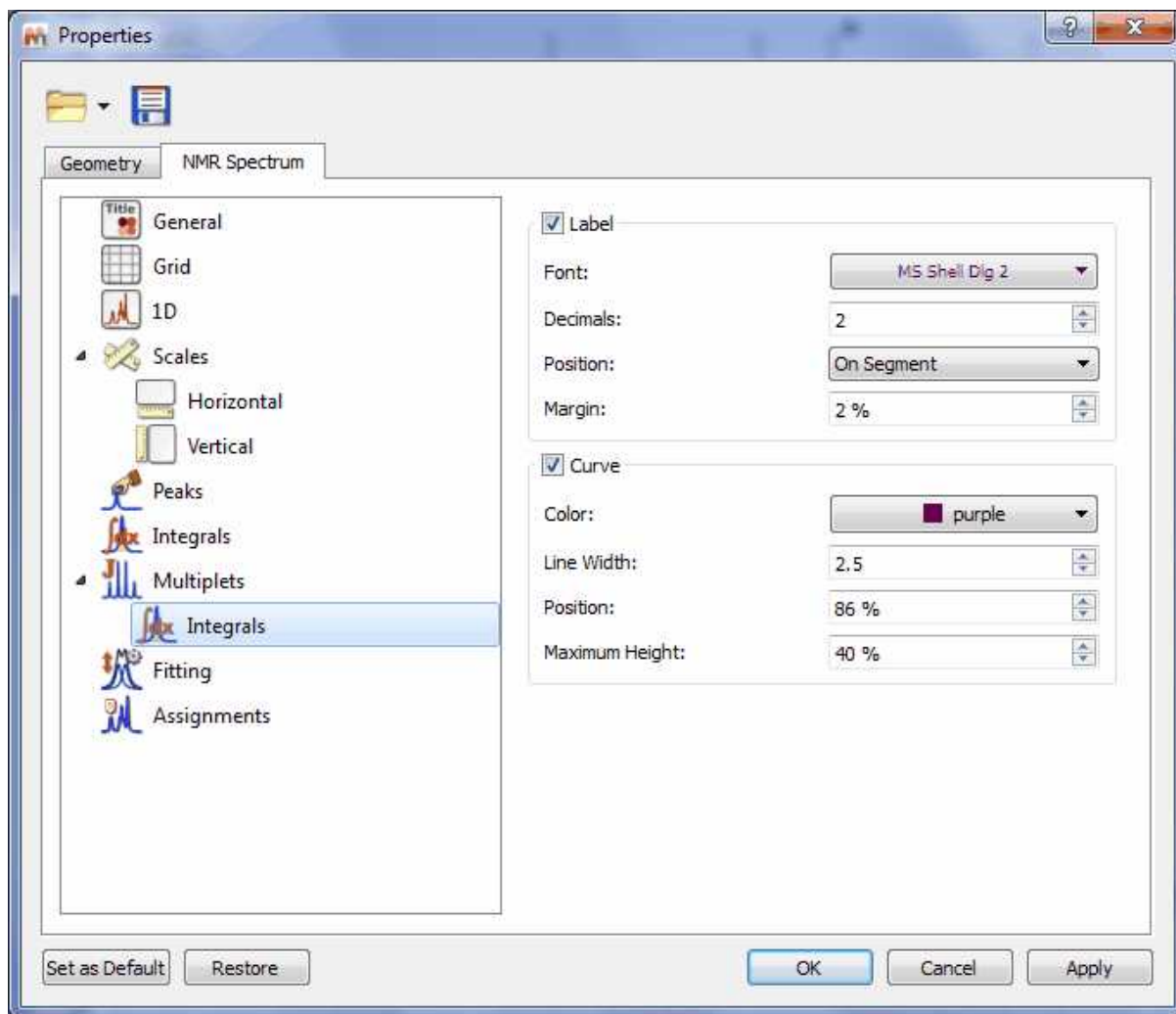

9.6 Mnova Verify

Mnova Verify is a new developing approach for structure verification by NMR and MS.

The pharmaceutical and biotechnology industries are currently facing very significant challenges which are resulting on major organizational and operational changes. The trend is for pharmaceutical companies to outsource many of their Research and Development operations to third parties with specific specialties and areas of expertise, in order to focus their own resources on areas where they are in a position to maximize value.

As a result, where many operations such as data mining, information sharing and decisions on chemical entities used to have to be carried out at an internal company level, now these same functions need to encompass the entirety of the supply chain and all partners involved in the

company's R&D effort. In addition, it is desirable to standardize data formats and data handling as much as possible, to keep tight controls on quality, particularly when compounds are being transferred between organizations and to optimize the sharing of information to maximize productivity.

A further challenge, which affects, among others, the domain of Analytical Data, is the reduction in the resourcing of internal support teams. In the case of Analytical Data, this means that, whilst progress in hardware capabilities and huge steps forward in automation allow us to generate very large amounts of analytical data in high throughput, a bottleneck is being created by the capability of Analytical Departments to get eyes on data. In this situation, overseeing also the data and proposed chemical structures proposed by partners outside the organization, and typically received in large numbers, is becoming harder and in most cases has been abandoned as an achievable objective.

Mnova Verify evaluates a series of elements (GSD, solvent recognition, novel similarity measure, multiplets and chemical shift predictions) and applies a scoring system to return a Yes/No/I don't know answer. This makes it a very powerful screening system useful for chemists who need to validate decisions as to the structure corresponding to their experiments, either in single or batch mode.



9.6.1 Single Mode

To run a verification in single mode, import into Mnova (by using the File/Open dialog or by dragging and dropping from the OS browser) a set of spectra (any combination of one ^1H spectrum, one HSQC and one LCMS or GCMS) and a single structure (.mol or .sdf).

Please note that our preference is to work with fid and ser files as opposed to processed data, as the optimal processing for the verification may differ from processing used for visualization, etc.

Optimally, prior to running the verification, ^1H NMR should be zero filled to 64K or 128K points and

should have no line broadening applied.

Once the data have been imported, invoke the 'Analysis/Verification' menu.

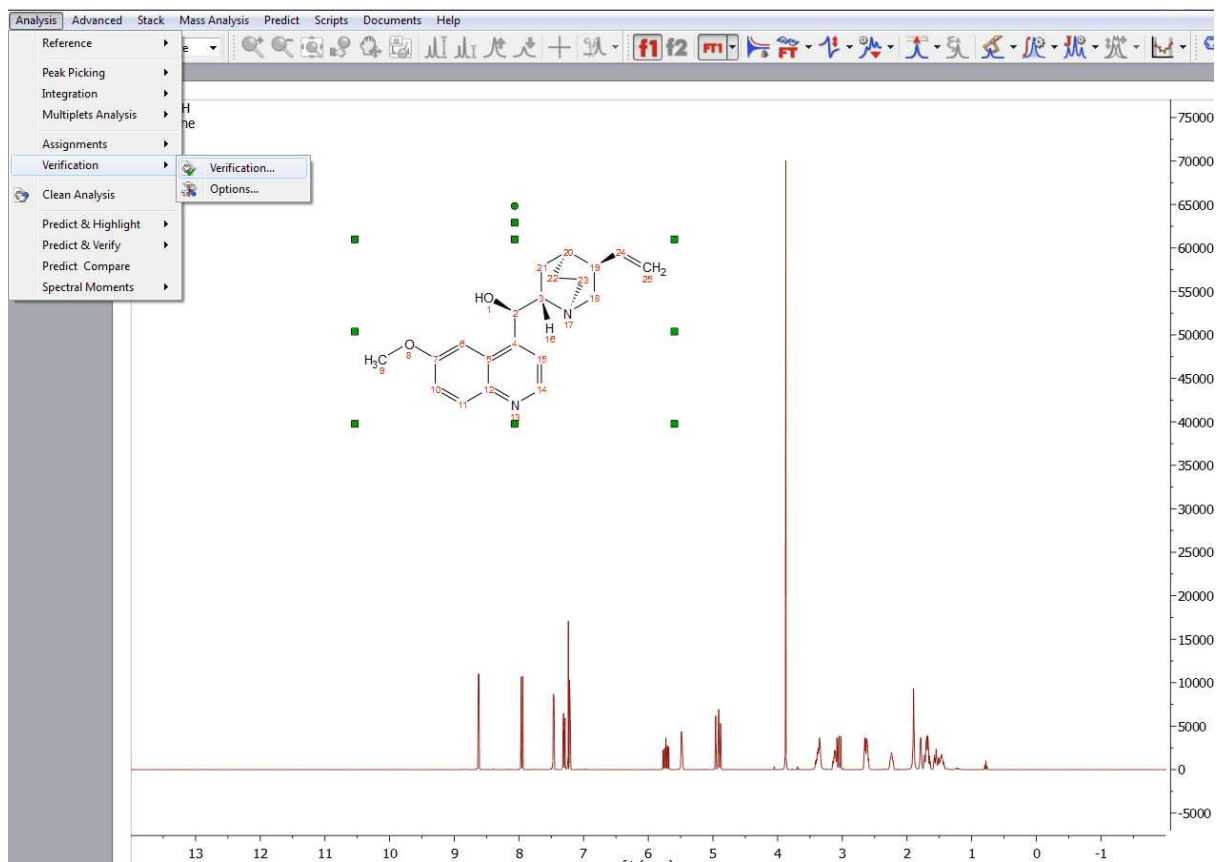

Once you have selected 'Verification'; the 'verification setup' dialog box will be displayed:

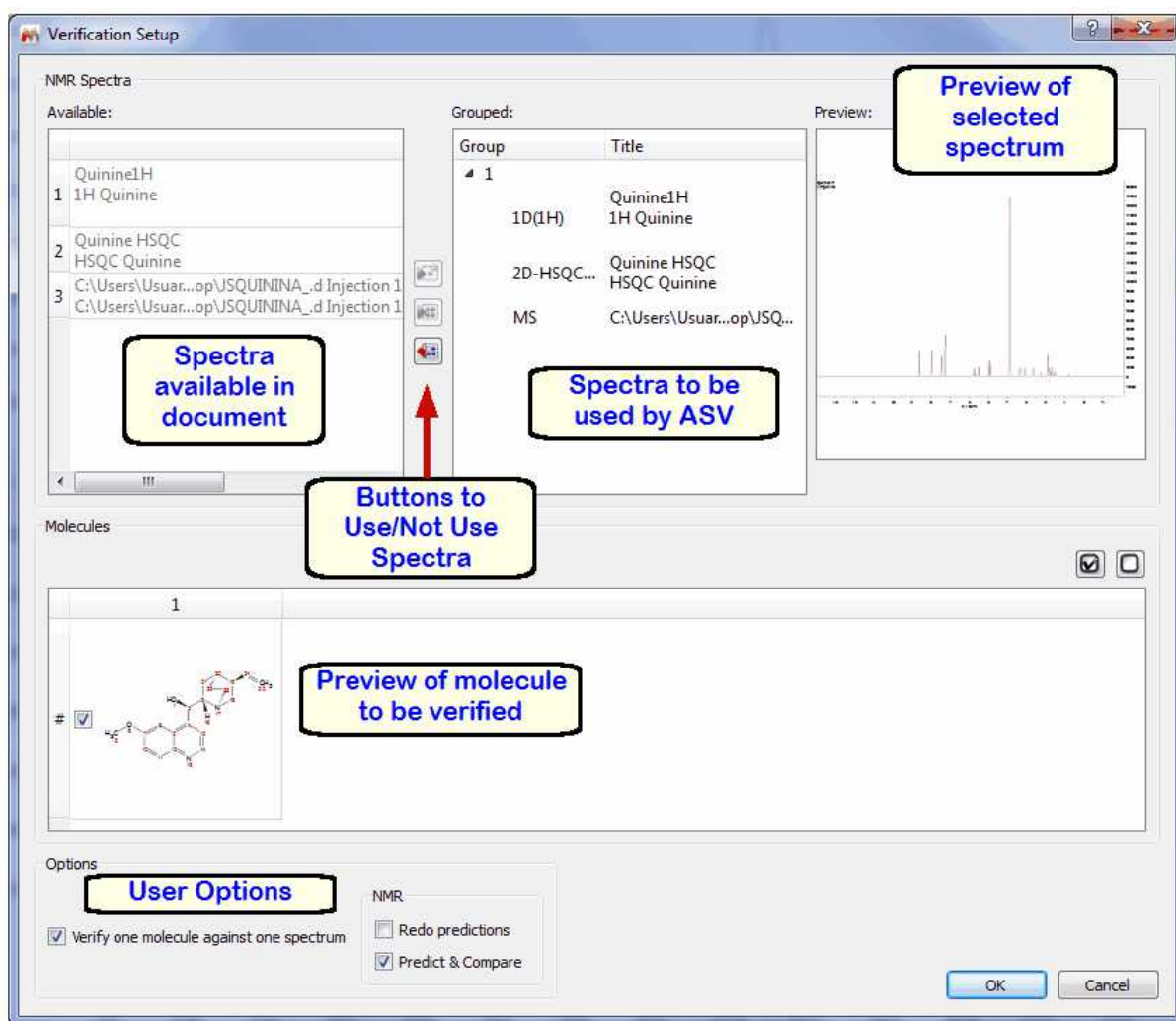

The document spectra panel displays the spectra which are available in the document.

The verification spectra panel displays the spectra which will be used for the verification (you could have some more spectra in the document which you do not want to use for verification, so this allow you to use only those which are relevant to you at that stage)

The spectral preview just shows you an image of the spectrum you have selected in the verification spectra panel (this could be handy when you are trying to decide maybe between 2 different 1H spectra to do the verification on)

The buttons to Use/Not Use spectra allow you to move spectra which are available on the document to the list of spectra to be used for verification or viceversa. To do so, just select the relevant spectrum and click on the relevant arrow to move from the list on the left to the list on the right or from the list on the right to the list on the left.

The molecule panel allows you to visualize the molecules you have available in the document and to select the one you want to verify by ticking it.

The User Options do the following:

Predict and Compare tick box allows you to select how you want the spectra to be presented after verification. If you tick the box, you will be presented with the experimental and predicted spectra in a stack:

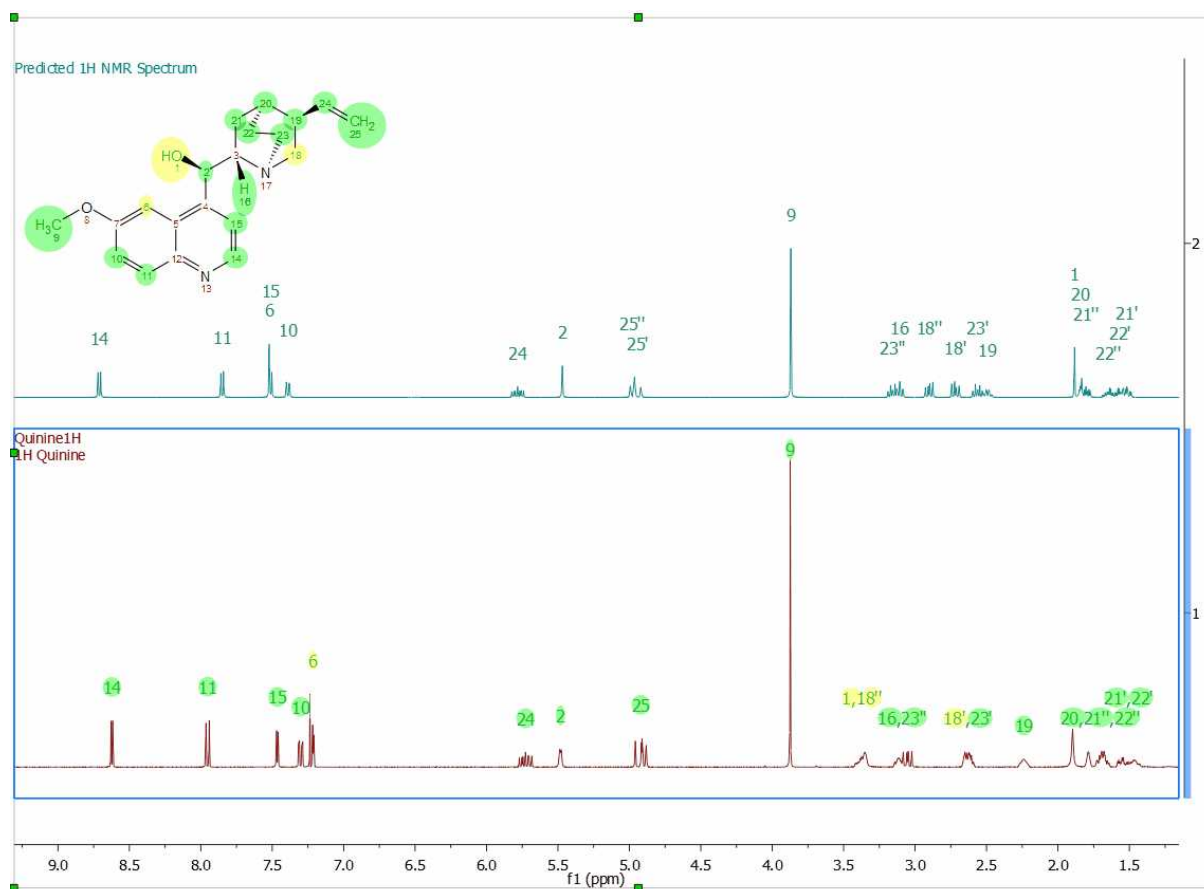

If you untick the Predict & Compare box, then you will be presented with just the Experimental spectrum:

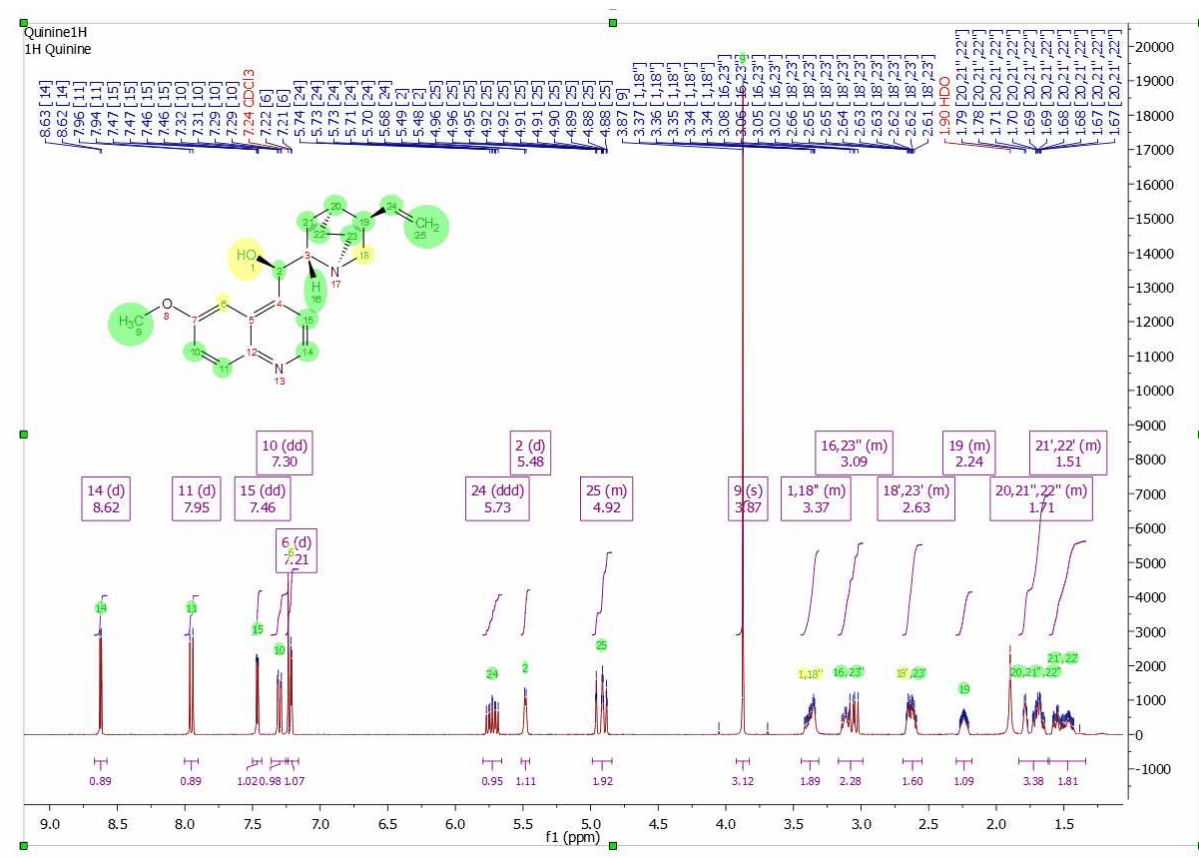

The 'Verify one molecule against one spectrum' box should always be ticked when running one spectral set against one single molecule, and the 'Redo Predictions' button is not relevant at this stage and will be explained later.

Click OK and verification will run.

Once you have run verification, you will be presented with the following:

1. Spectrum/spectra, in your chosen view mode (Predict & Compare or Active)
2. A table of verification results which should appear after you run. If not, turn it on by using the 'View/Tables/Verification Results' menu.
3. The structure, annotated with colour coded assignments.

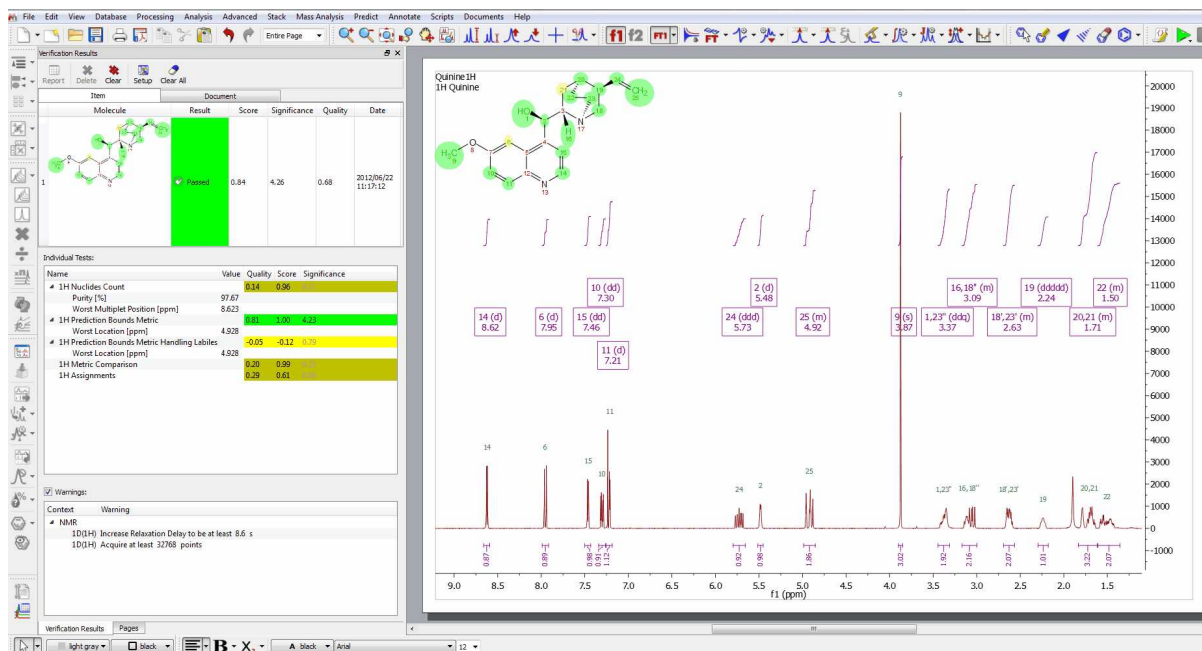

The paper area will present the spectra annotated with the assignments the software has made to the molecule and the molecule with each atom colour coded by quality of assignment (green is a good assignment, yellow is poorer assignment and red is a bad assignment but which still allows the software to make a total assignment of the structure).

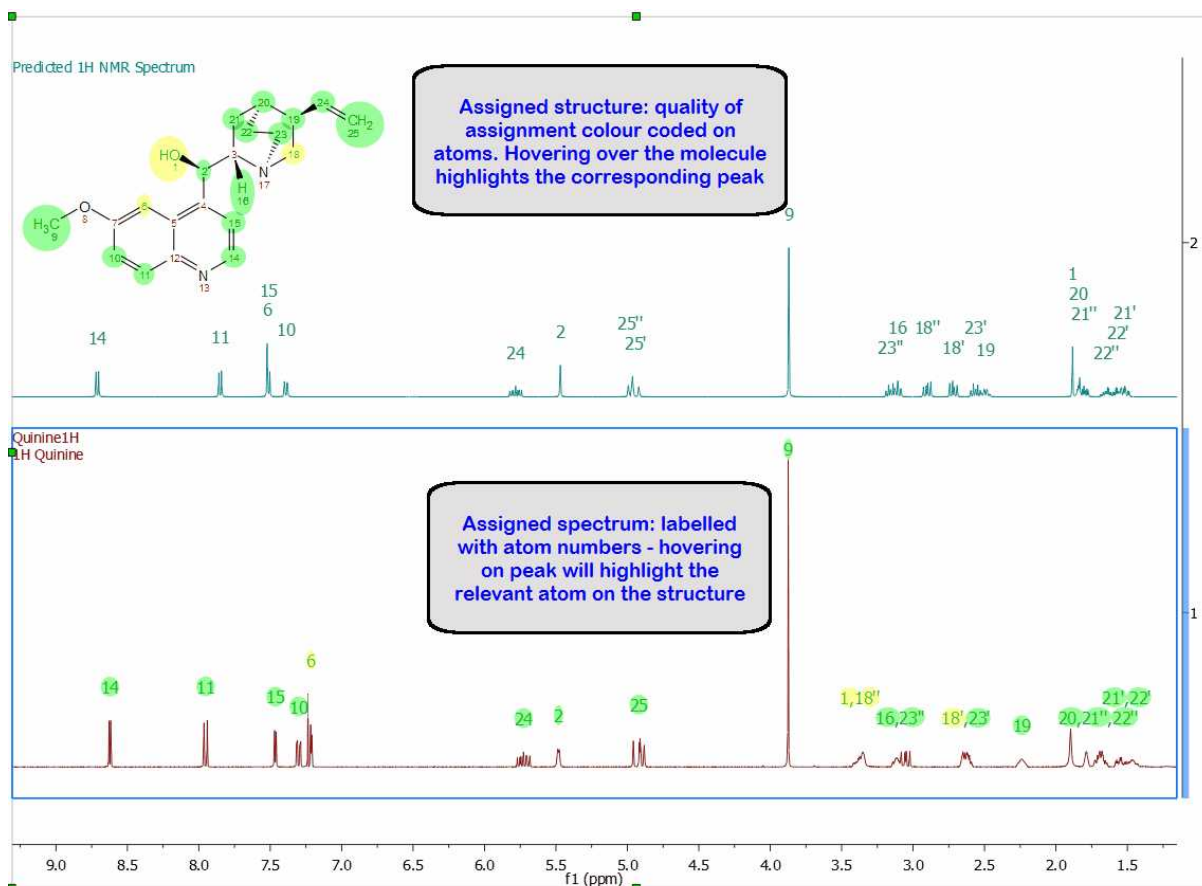

In the case of HSQC, the software will present you with the assigned molecule and assigned HSQC spectrum, with the assignment labels for the spectrum placed at the top of the paper. In addition, the spectrum is marked with colour coded rectangles as follows:

- A green rectangle represents a predicted 2D range for a peak, which does have a real peak within it, therefore indicating a good match between experimental and predicted peaks.
- A yellow rectangle represents a predicted 2D range for a peak, which has a real peak very close to its edge, therefore indicating an acceptable but less reliable match between experimental and predicted peaks.
- A red rectangle represents a predicted 2D range for a peak, which does not coincide with any experimental peaks, and therefore indicates a significant difference between a predicted and experimental peak or the complete lack of an experimental peak.
- A peak without a rectangle means that there is an experimental peak present where the prediction does not expect any peaks

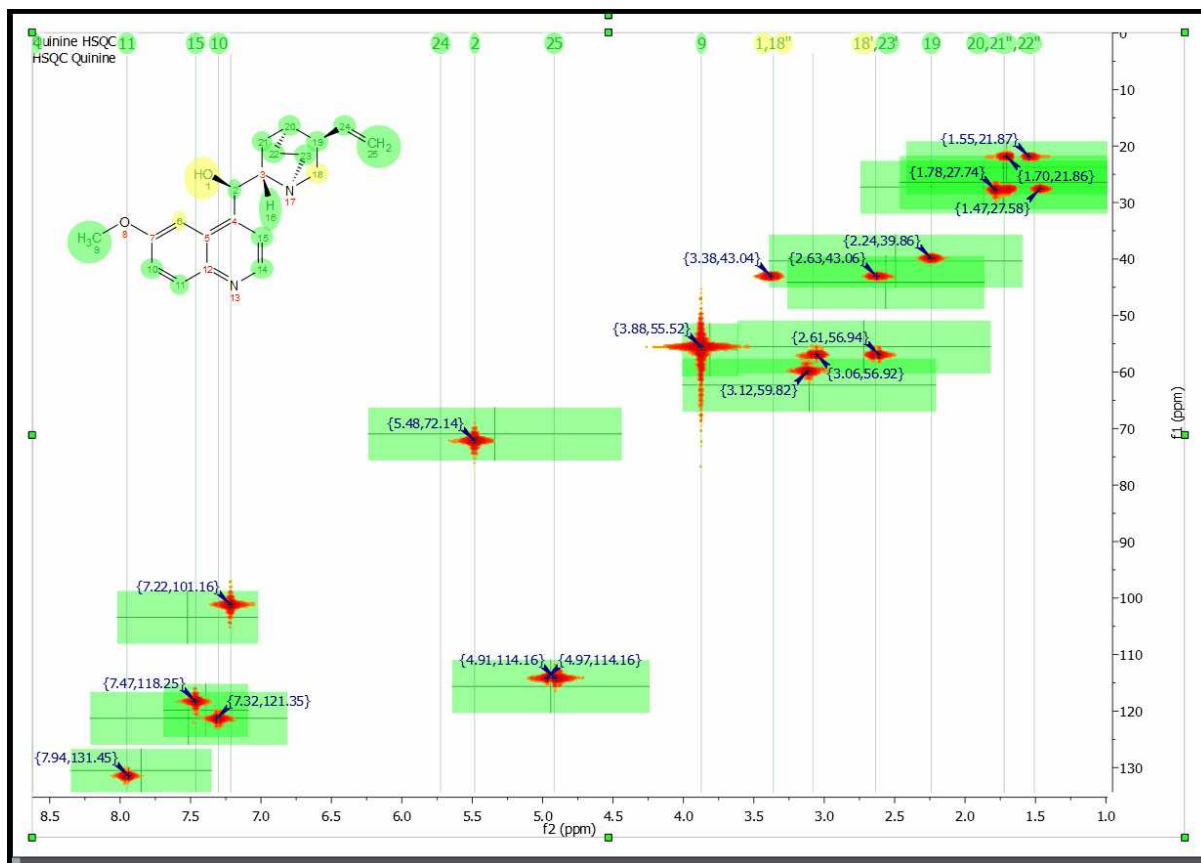

As for the Verification Results table, this table has 2 parts, a top part with the structure and the summary scores, and a bottom part with the Score, Significance and Quality for each individual test and some additional information, which is designed to help you identify quickly possible reasons for a failure:

- Under 1H NN test: Purity – This is an estimation of the purity of the sample calculated by NMR
- Under 1H NN test: Worst Multiplet – This is the location of the real multiplet which is furthest away on the chemical shift scale from its predicted counterpart
- Under PBM Test: Worst location – This is the location of the predicted multiplet which is furthest away on the chemical shift scale from its experimental counterpart
- Under HSQC XCorrelation Test: Effective number of missing cross peaks and Effective number of extra cross peaks: These are a summary of the number of non-matching predicted and experimental peaks in the HSQC.

Molecule	Result	Score	Significance	Quality
1	Passed	0.67	9	0.61

Name	Value	Quality	Score	Significance
1H Nuclides Count		0.11	0.27	
Purity [%]	92.83			
Worst Multiplet				
Position [ppm]	3.897			
Score	0.6			
1H Multiplets Count		0.24	0.92	
1H Prediction Bounds Metric		0.79	1.00	4
Worst Location [ppm]	3.64			
1H Prediction Bounds Metric Handling Labiles		0.65	1.00	
1H Metric Comparison		0.01	0.02	
1H Assignments		0.40	0.82	
HSQC Cross Correlation		0.68	0.93	
Effective number of missing cross-peaks	0.0			
Effective number of extra cross-peaks	0.0			
Aromatic Pattern Substitution		-0.07	-0.08	5
MS Molecule Match Score		0.69	0.91	
MS Molecule Match Similarity		0.69	0.91	
MS Molecule Match Purity		0.10	0.13	

Summary verification result for the structure, with the summarized score, significance and quality

The individual test results, with their score and significance

Once the data is processed and made ready for the verification, a series of tests of the hypothesis that the proposed structure is the major component of the sample are carried out. For an effective automatic structure verification system when many of the parameters being considered by it may well be imperfect (integration, spectral analysis, predicted chemical shifts, etc.) it is fundamental that the system has the capability to weigh different results in different ways and to auto-evaluate the importance of specific tests in specific conditions. This allows the system to become robust to a level of uncertainty in the quality of the inputs. Therefore, the single tests may have not only a score but a different significance which, in addition, may correlate with the principle outcome. Each test generates a pair [probability, significance]:

- **Score:** This is the result of the test, where a value of 1 means that the hypothesis fits perfectly with the experimental data, whilst a score of -1 means that the hypothesis is a perfect failure and therefore definitely wrong.
- **Significance:** Each test, depending on the characteristics of the data, the proposed molecular structure, the prediction quality for the given HOSE codes or chemical environments present on the molecule, etc., gets given a significance. Thus, a high level of impurities in the spectrum may reduce the significance of tests which rely heavily on integration, whilst a poorly predicted chemical environment may reduce the significance of a test relying heavily on chemical shift prediction. Significances of 0-2 are low, 3-5 are medium and >5 are highly significant. There is no theoretical limit to the value of significance, if a test could be devised which was fully deterministic and completely infallible, this could have infinite significant within this concept.

Currently, the system is carrying out a series of tests which are designed to be complimentary and run in parallel and which, at high level, can be described as follows:

- **1H NN Test:** Number of Nuclides – the number of nuclides present in the spectrum is calculated independently of the molecular structure (by applying Bayesian probability to attempt to fit the set of integrals observed in the experimental spectrum to a set of integer numbers and taking the highest probability solution as the number of nuclides) and compared to the number of nuclides counted in the molecular structure.
- **1H Multiplet Count** – The number of observed separate multiplets is compared to the number of separate multiplets observed from the structure.
- **1H PBM test:** Prediction Bounds Metric Test – Each atom in the molecular structure is given a chemical shift and an allowable range based on the quality of the prediction for its specific environment. The software then checks whether a multiplet with the right number of nuclides is present within that allowable range.
- **1H PBM Handling Labiles:** Prediction Bound Metrics Handling Labiles Test – As above, but multiplets labeled as labile by the Autoedit analysis step are ignored from the comparison.
- **1H Global Comparison:** This is a fitting between the experimental spectrum and a simulated spectrum generated from the prediction values by using full quantum mechanics. The lower the residue of the best possible fitting, the higher the score of this test.
- **Assignments:** The full spin system for the proposed molecular structure is built and compared to the experimental data. Every possible assignment of the multiplets in the spectrum to the spin system (and through it to the atoms) is enumerated and its likeability calculated by a merit function. The highest positive result of the merit function will be reported as both as verification test result and as automatic assignments made on the structure/spectrum pair.
- **HSQC Cross Correlation Test:** The HSQC spectrum for the structure is predicted and each predicted peak is given a 2 dimensional allowable range. Each of these ranges is then evaluated as to whether a real peak is present within them, and whether there are ranges with missing peaks or real peaks which don't correspond to allowable predicted ranges.
- **MS Molecule Match Score / MS Molecule Match Similarity:** For each proposed structure's molecular formula, with the given ionization mode (such as protonation), a molecular ion cluster spectrum is computed. Each molecular ion cluster spectrum is then compared to every spectrum in the LC- or GC- MS run, and ranked according to spectral similarity, where 1.0 is identical within the m/z region of the molecular ion cluster. This ranking is further refined by taking into account the response of a molecular ion chromatogram (or chemical chromatogram) , which also has a maximum value of 1.0. The final match score is the product of the two metrics. The MS Molecule Match similarity measurements are derived from traditional dot product calculations and take into account a user specified m/z accuracy, to make full use of accurately mass measured mass spectral data. If MS/MS spectra are also present in the data set, the structures are used to predict fragment spectra, and these predicted fragment spectra are compared with the acquired MS/MS spectra.
- **MS Molecule Match Purity:** This is calculated as the sum of the intensities corresponding to the matched isotope cluster expressed as a percentage of the sum of all the intensities in the matched MS spectrum and it is used as an indication of the potential reliability of the MS

Match tests.

The Quality Score corresponding to each individual test is generated by combining the Score and the Significance for that test. The objective of this Quality Score is to generate one single number to allow easy comparison when handling large volumes of data.

9.6.2 Options

Following the menu 'Advance/Verification/Options' will display the dialog box below:

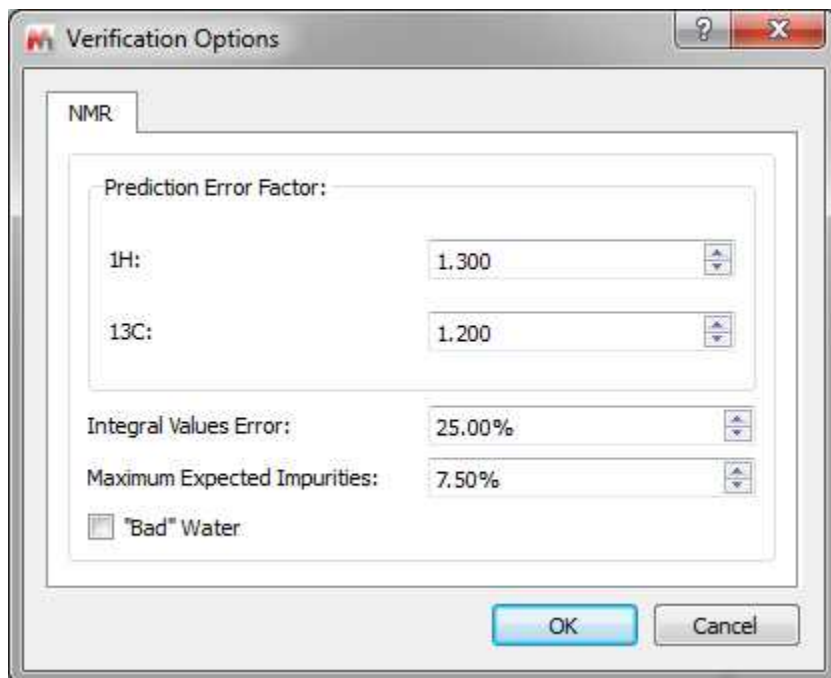

From here, you will be allowed to change the prediction error factors and to select a threshold for the integration values and the percentage of impurities.

NOTE: The option to ['clean analysis'](#) (under the Analysis menu) could be useful to rerun a verification after having changed the options.

9.6.3 Troubleshooting a negative result

What happens if I get a negative verification result?

There are several reasons to get negative results in the verification. Let's take a look at some of them

1. **All or most of the NMR tests fail with bad scores:** this could be an indication of either the wrong structure, a very poor quality spectrum or **solvent misrecognition, which will affect most tests very significantly**. The recommended Operating Procedure is to check the solvent recognition first. To do so, make sure you are in 'Active Spectrum' mode and that your graphical properties (Edit/Properties/NMRSpectrum/Peaks/Curve) has the 'Peaks' box ticked. This will display colour coding for the autoediting carried out by the software on the spectra. You may identify this way that a solute peak has been considered as solvent or viceversa.

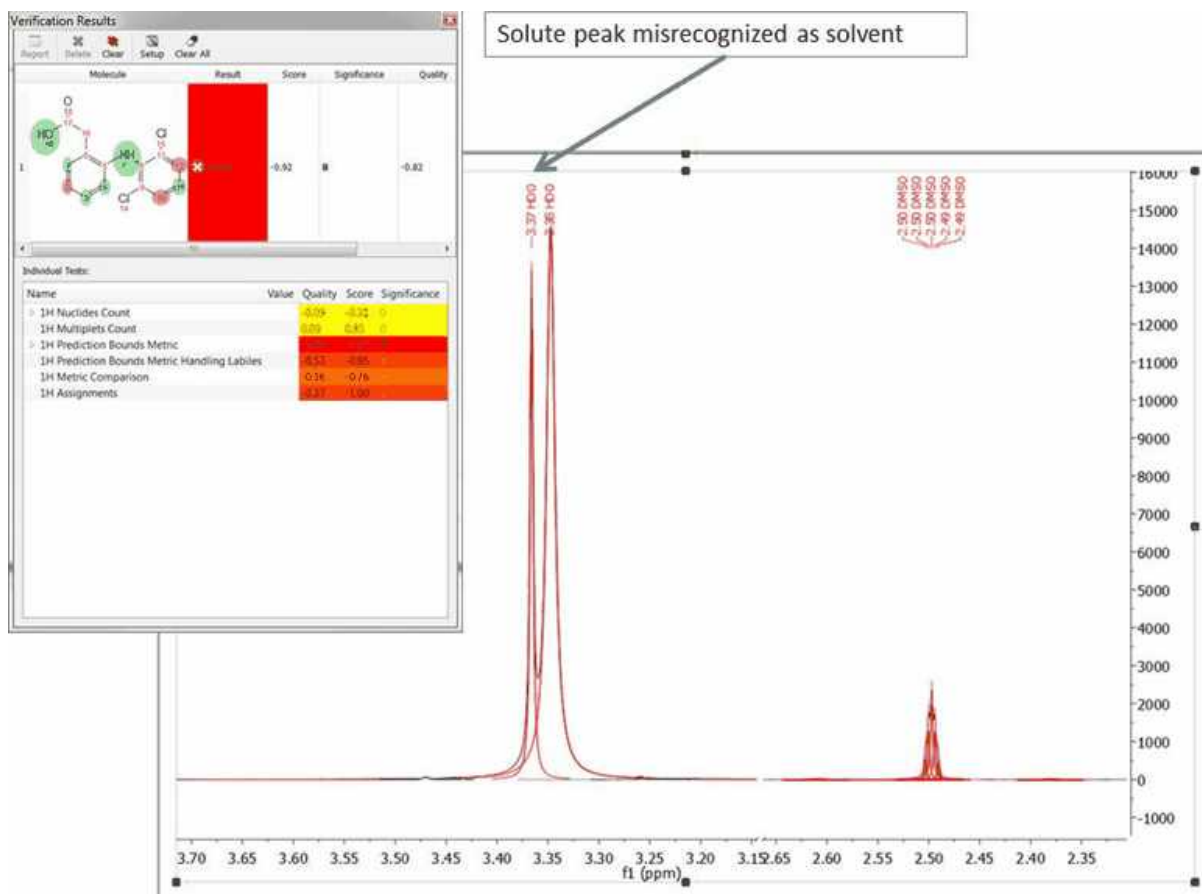

In a case in which this happens, this can be corrected by right clicking on the peak label (pointed at by the arrow on the figure) and selecting Edit Peak Type, then marking this peak correctly (in the case above would be marked as compound and with the Flags unticked...)

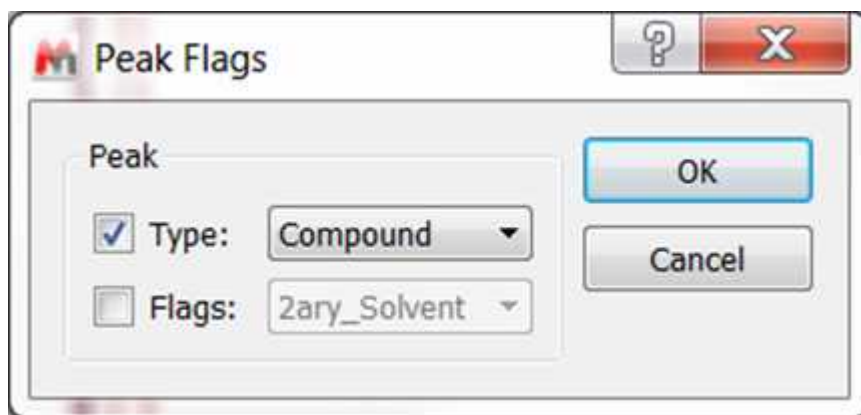

Once GSD/AutoEdit has been modified, you can just re-run Verification and your GSD modifications will be respected. In this case, after running again, the result is totally different, as can be appreciated in the figure below:

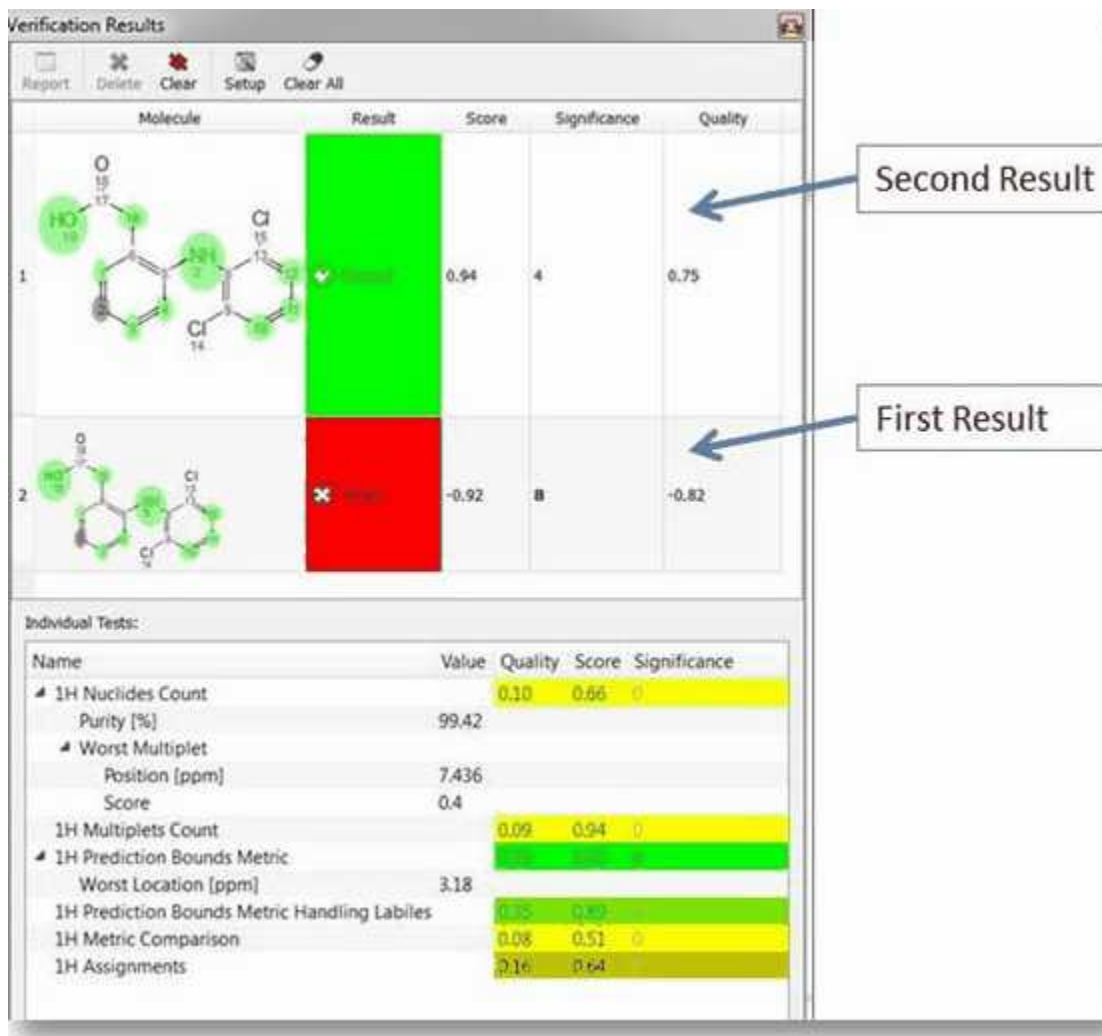

2. **Should you find that the score is reasonable but that some atoms are showing assigned in red and that either the PBM or NN tests have low values**, then this could be due to an **inaccurate prediction** or to an atom which is not where it is supposed to be (in the latter case this would be a true negative result). In this case, check the 'Worst Multiplet' and 'Worst Location' feedback, as this might indicate where you should look first. In the case of the figure below, 'Worst Location' is 9.49 ppm, and there we can see that there is a peak, which is being assigned to atom number 11, but the predicted value for atom number 11 is at 8.75 ppm. The user can decide here whether it is reasonable that the prediction is poor and that the real value of atom 11 could indeed be 9.49.

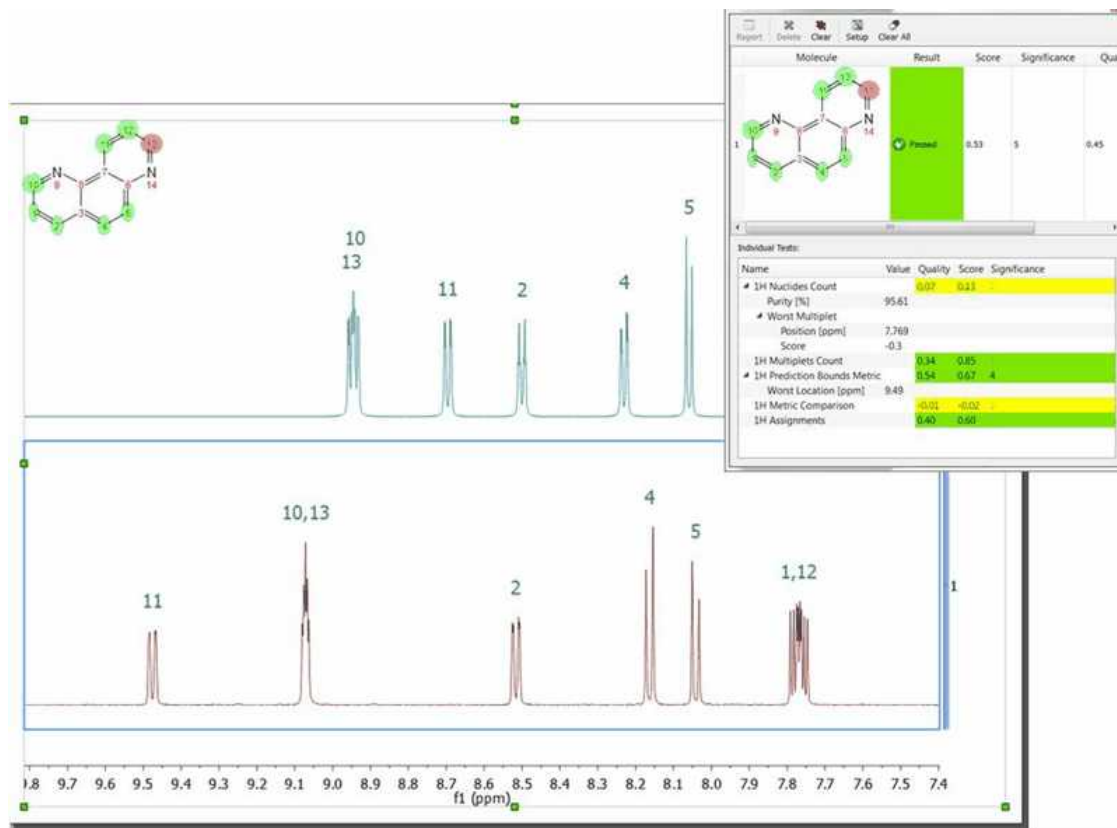

In this case, the user can grab the prediction label by clicking on it (the number 11 label on the blue spectrum) and moving it to the 9.49 ppm position. Once this has been done, the verification can be carried out again, making sure that the 'Redo Predictions' tickbox in the verification dialog is unticked. This will allow the user to see what the result of the verification would be in case the prediction was being made at 9.49 ppm, rather than 8.75 ppm. In this case, as the figure below shows, the verification 'Score' has improved from 0.56 to 0.82 and the atom which was badly assigned (colour coded in red on the molecule previously) is now well assigned. Should the user decide that the presence of atom 11 at 9.49 ppm is possible given its chemical environment, then this is a likely indication that the reason for the previous lower score was simply a poor prediction.

Verification Results

Report Delete Clear Setup Clear All

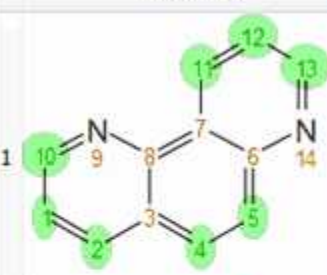
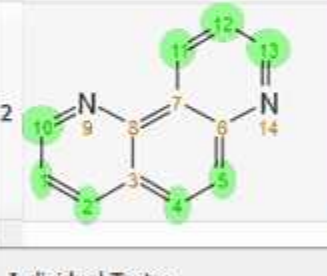
Molecule	Result	Score	Significance	Quality
1 	✓ Passed	0.82	5	0.68
2 	✓ Passed	0.53	5	0.45

Individual Tests:

Name	Value	Quality	Score	Significance
▶ 1H Nuclides Count	0.07	0.13	1	
1H Multiplets Count	0.34	0.85	1	
▶ 1H Prediction Bounds Metric	0.79	1.00	4	
1H Metric Comparison	0.27	0.52	1	
1H Assignments	0.56	0.86	2	

3. **A low result in 1H Nuclides Count and 1H Multiplets Count test** could also be indicative of poor integration due to either impurities or a very short relaxation time. It is to be noted that a very short relaxation time can affect integration and that poor integrals will have a negative impact on the verification result. This can be thought of as a false positive but in fact the software is reporting a problem or incompatibility in the data with the proposed molecule.

9.6.4 Rank potential molecular candidates

Mnova Verify can also be used to run one set of spectra against more than one potential structural candidate (or viceversa). Taking as an example a situation where we have one single spectra set (1H only, for example), as we can see in the figure below:

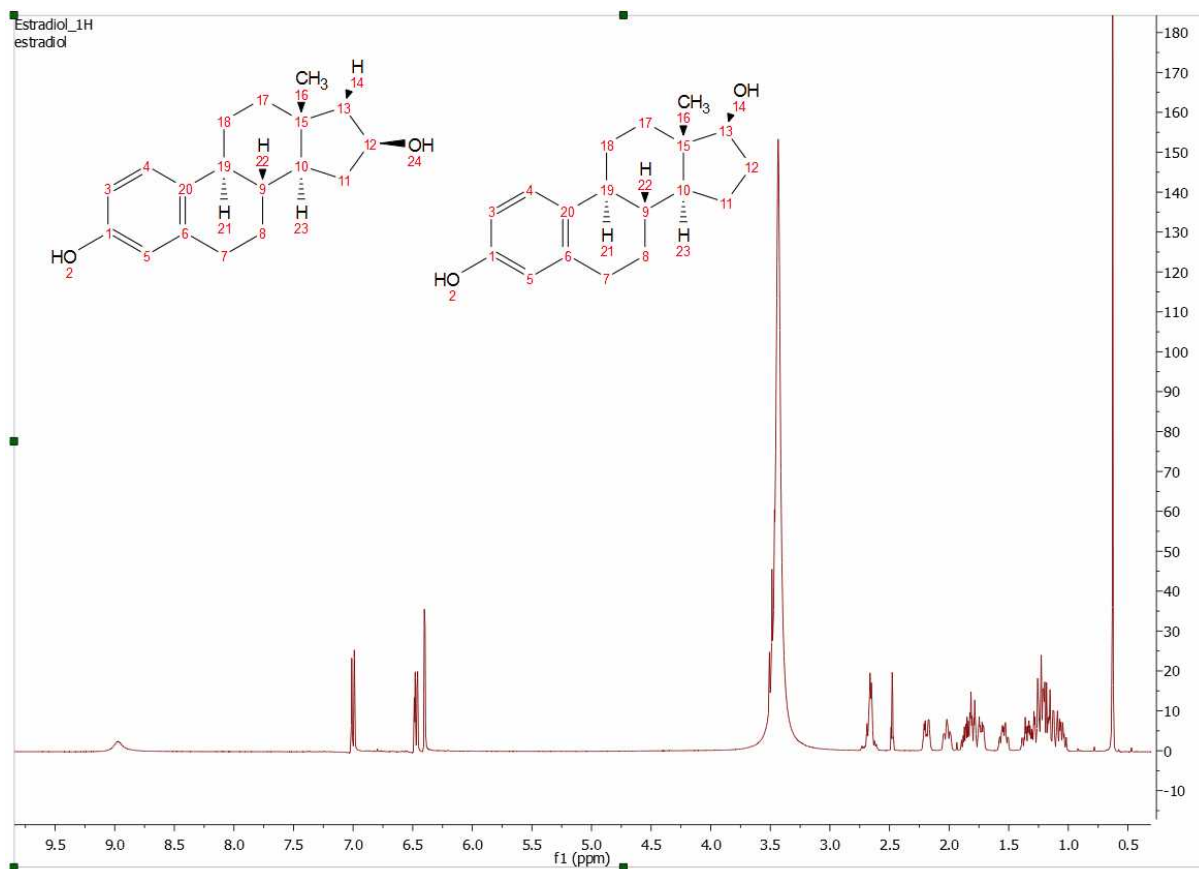

It is possible to use Mnova Verify to rank these 2 structural candidates on the basis of their NMR. To do so, we would run the 'Advanced/Verification' command, but in this case making sure that the **'Verify one molecule against one spectrum' option is unticked**, as the count of structures and spectral groups to verify against differ.

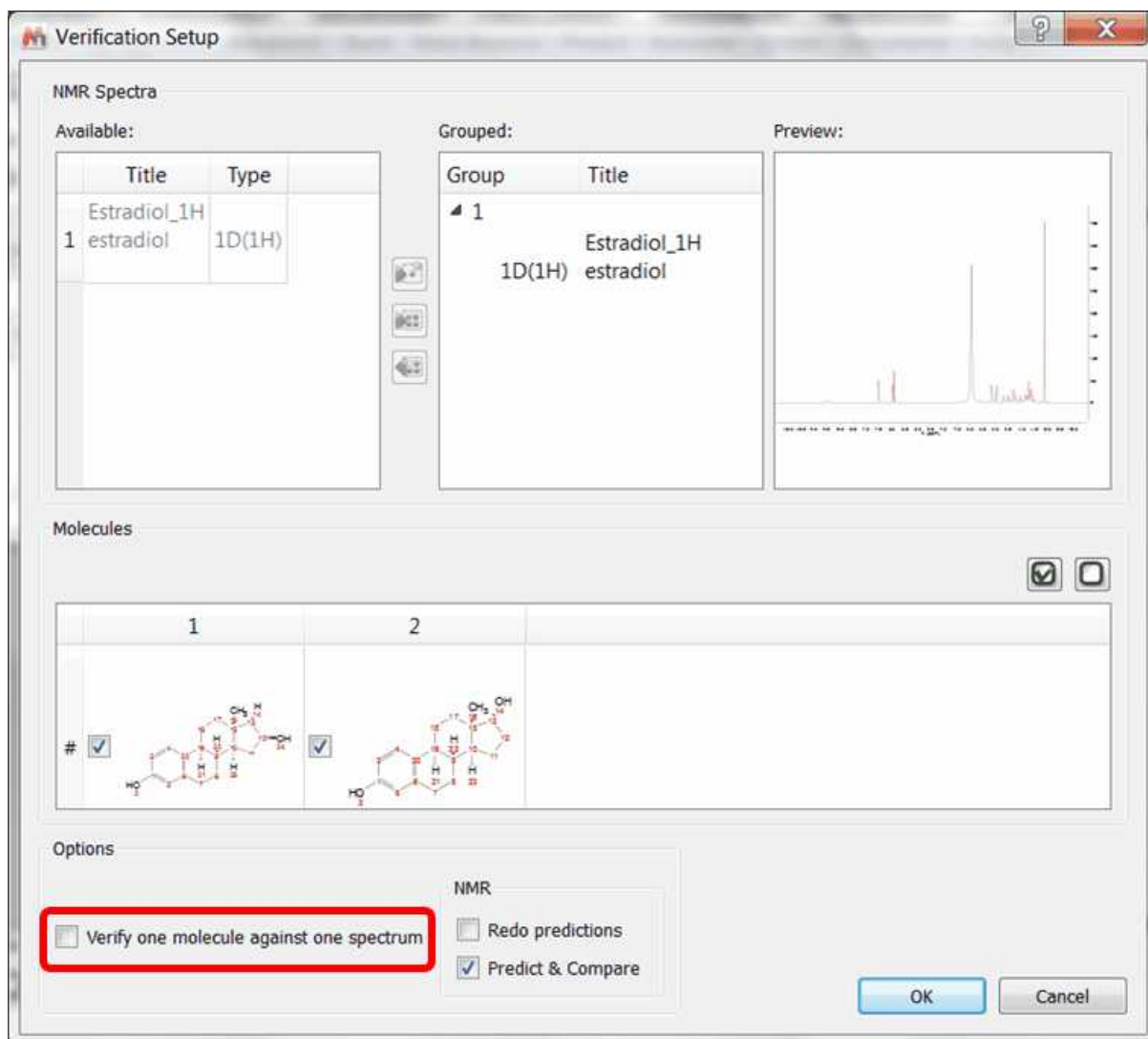

ran

The software will run the spectral set against both structures and present the user with a score for each structural proposal, which may in many cases allow the user to differentiate between 2 possible candidate structures.

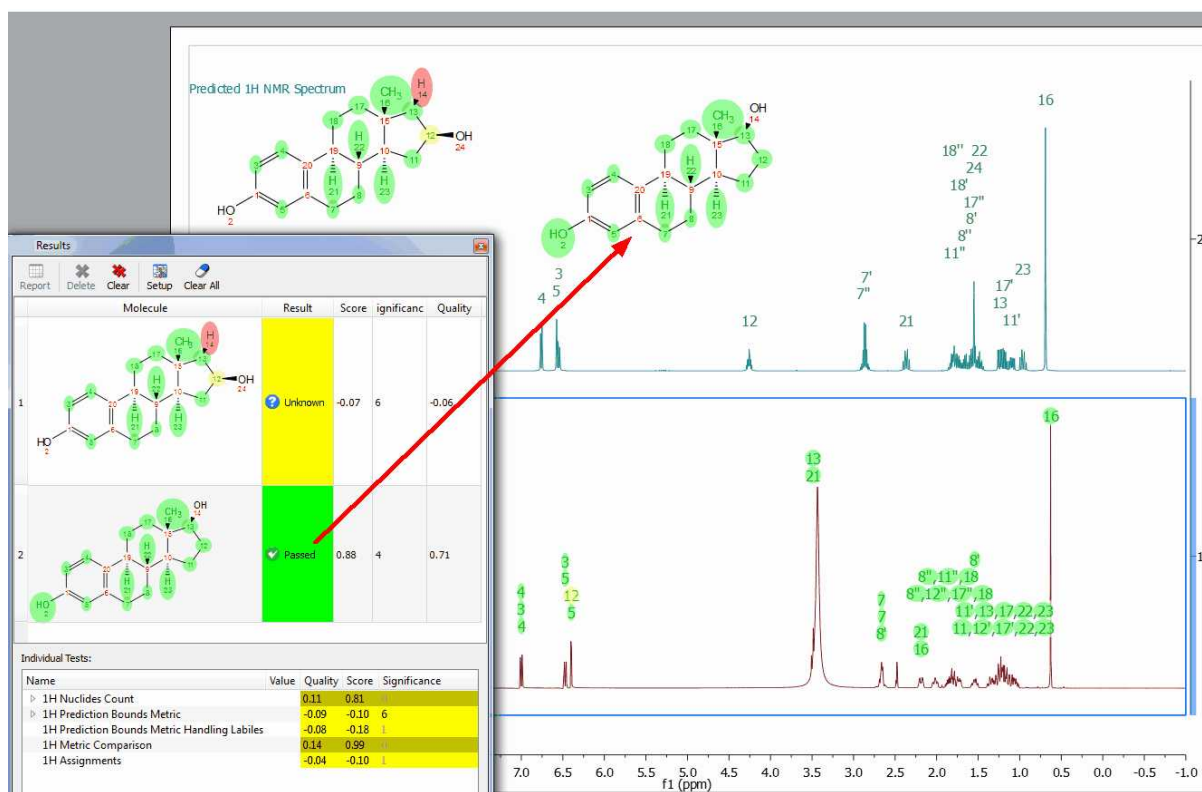

This is one of the areas where having the ability to combine NMR and MS data can prove very powerful. In the following example, ^1H NMR alone does not distinguish between the structures on the total score, as the only difference is in a different nuclei (S or O) (although there are already some indications that one structural proposal has greater merit than the alternative in the quality of the assignments made by the verification module and reflected in the colour coding).

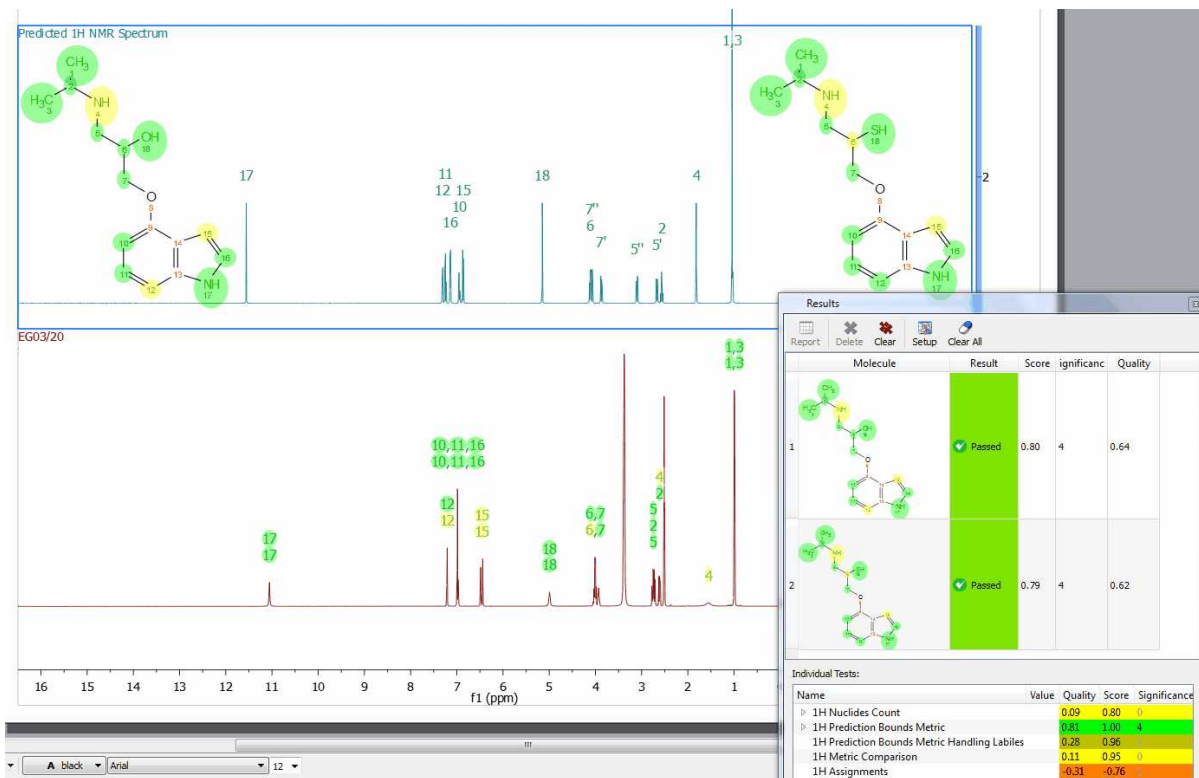

Should the user have MS data in this example, however, the difference between both proposals would be immediately obvious:

Results

Report Delete Clear Setup Clear All

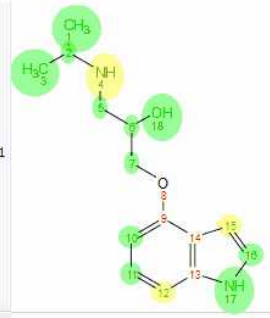
Molecule	Result	Score	Significance	Quality
	Passed	0.80	8	0.71

Individual Tests:

Name	Value	Quality	Score	Significance
1H Nuclides Count	0.09	0.80	0	
1H Prediction Bounds Metric	0.81	1.00	4	
1H Prediction Bounds Metric Handling Labiles	0.28	0.96		
1H Metric Comparison	0.11	0.95	0	
1H Assignments	-0.31	-0.76	1	
MS Molecule Match Score	0.75	0.99	5	
MS Molecule Match Similarity	0.75	0.99	5	
MS Molecule Match Purity	0.10	0.13	3	

**Verification result First
Structure- High MS Scores**

Results

Report Delete Clear Setup Clear All

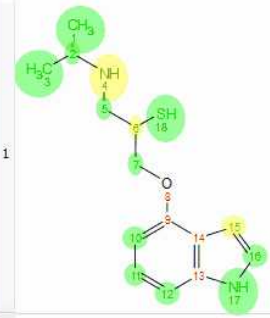
Molecule	Result	Score	Significance	Quality
	Failed	-0.81	10	-0.75

Individual Tests:

Name	Value	Quality	Score	Significance
1H Nuclides Count	0.09	0.80	0	
1H Prediction Bounds Metric	0.81	1.00	4	
1H Prediction Bounds Metric Handling Labiles	0.25	0.87		
1H Metric Comparison	0.11	0.95	0	
1H Assignments	-0.33	-0.79	1	
MS Molecule Match Score	-0.91	-1.00	10	
MS Molecule Match Similarity	-0.91	-1.00	10	
MS Molecule Match Purity	-0.91	-1.00	10	

**Verification result Second
Structure- Very Low MS Scores**

9.6.5 Verification in batch mode

Mnova Batch Verify evaluates analytical data and makes a judgment as to whether they are compatible with the structures proposed by the user in full automation mode (from libraries or at the point of data acquisition by using the Listener). This plugin is sold apart and a specific license is needed. You will need to install the Batch Verify plugin by following the menu 'Edit/Advanced Plugins' and clicking on the 'blue plus' button.

With this plugin licensed, it would be possible to run verifications in Mnova in batch mode by following the menu 'Analysis/Verification/Batch Verification':

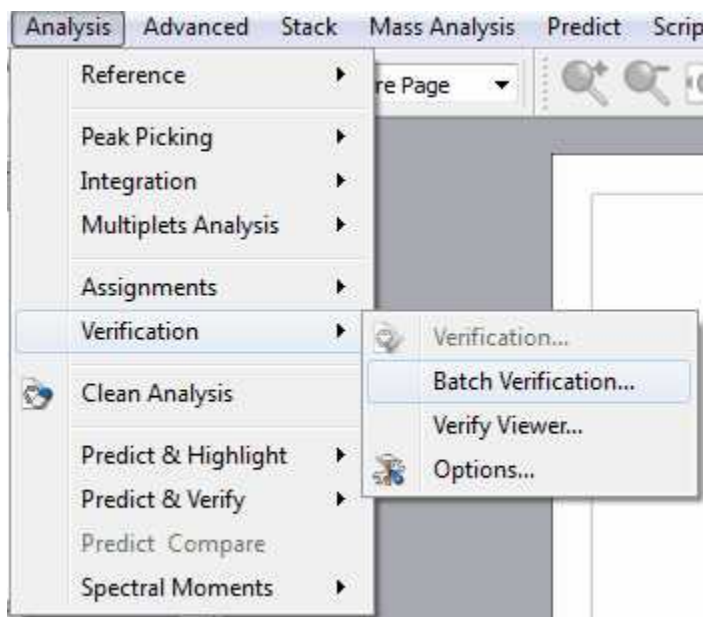

This script will run a set of spectra against a set of molecules. Once the user has invoked the script, a dialogue will be presented, where a set of information can be entered.

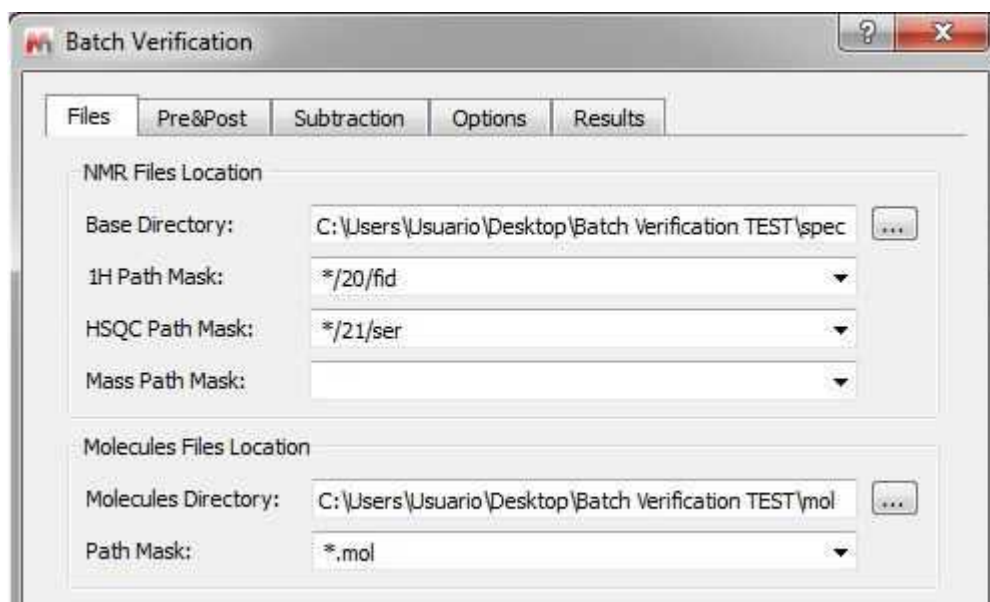

Base directory for the location of experimental files: The directory containing all the experimental data should be entered here.

1H Path Mask: Should the user desire to use 1H spectra as part of the verification, a file mask describing how to open each of the spectra should be entered here. All Operating System standard conventions apply (*, ?, !, etc.).
In the example above the 1H datasets are in stored in C:\Users\Usuario\Desktop\Batch Verification TEST\spec\Paper_01 (Paper_02, Paper_03 and so on):

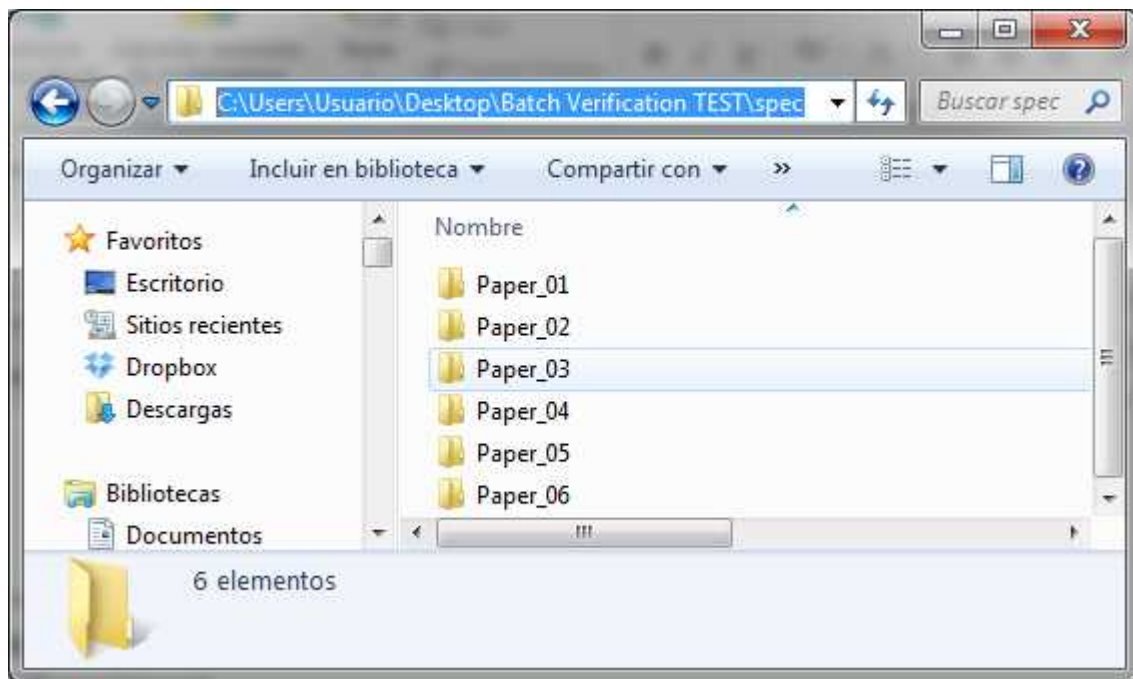

HSQC Path Mask: Same for HSQC.

MS Path Mask: Same for MS data.

The scroll down menu of the Masks will hold the last 5 used masks. Please bear in mind that it will be possible to use more than one mask at a time by separating the masks with the character |. This separator will be inserted automatically if the mask is chosen from the list.

Molecules File Location: The location of the .mol files to verify against can be entered here, as well as the File Mask to each one of the individual .mol files.

Selecting the 'Pre&Post' label, a new dialog will be displayed:

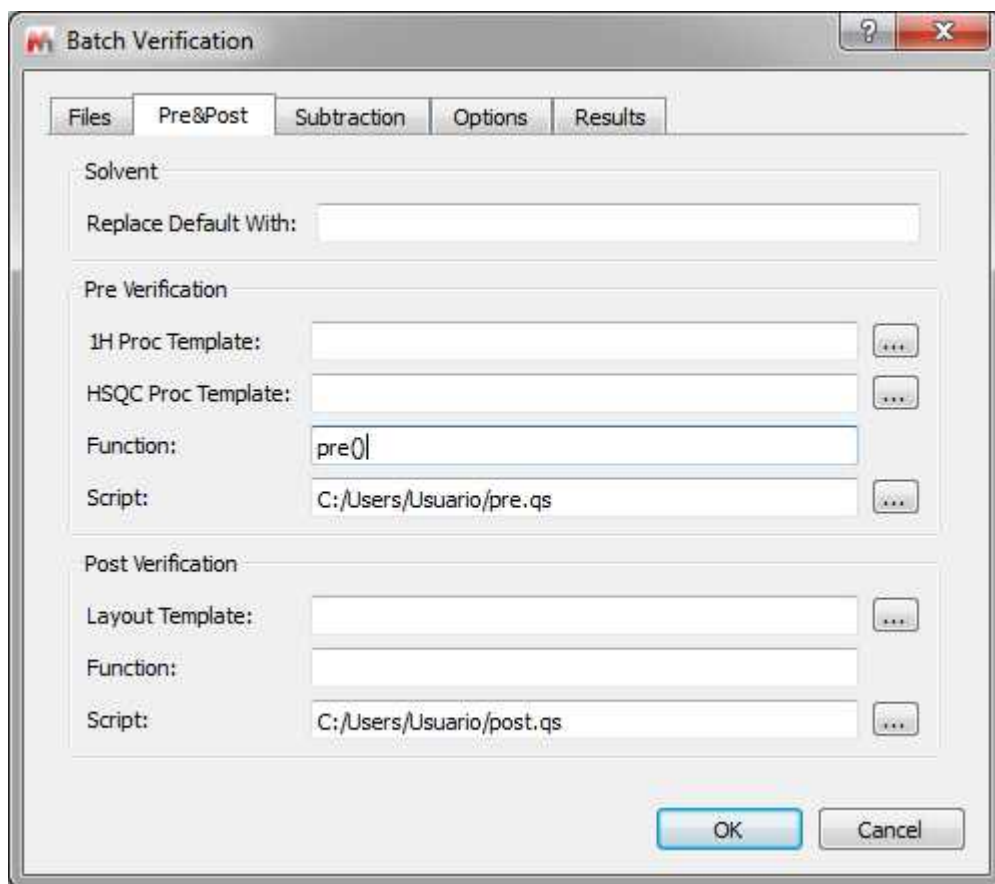

Solvent/Replace Default With: This allows users to handle situations in which the solvent may be wrong in the parameters. It can be the case that a certain batch has been run on a specific solvent but that the user left the default solvent on the spectrometer data entry and therefore the solvent could be wrongly entered. Since the target solvents will affect the performance of the Autoedit function in Mnova Verify, it is important to be able to correct for this at the script level.

Pre-Verification: This allows the user to select a script or function the user would like to run prior to each verification being performed. There could be many examples of this. One obvious example would be a script to remove from the GSD input peaks belonging to a known impurity (THF, iPrOH, etc.)

Post-Verification: This allows the user to select a script or function the user would like to run after each verification is performed. There could be many examples of this. One obvious example would be a script to perform and report qNMR on the data being verified, or a script to apply a specific reporting template, or to save the results to an ELN or other external database.

Clicking on the 'Subtraction' label, you will get the dialog box below:

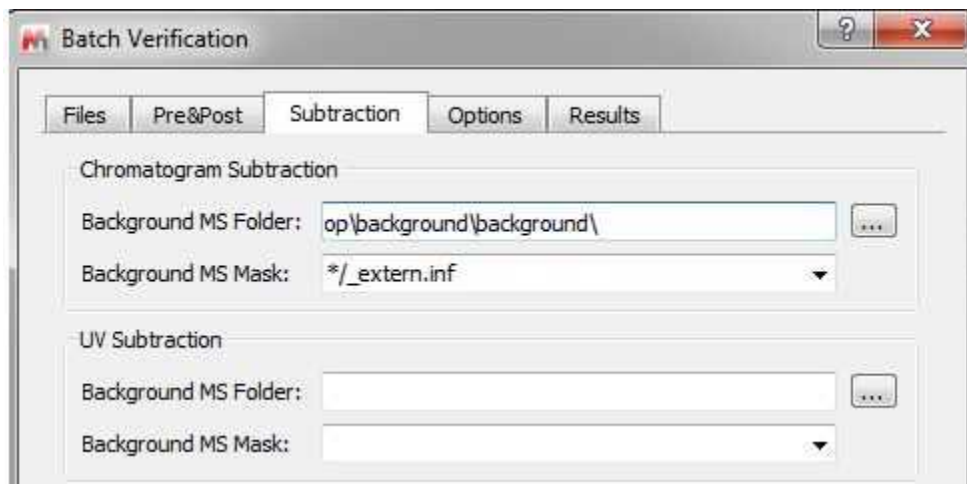

It will be possible to subtract chromatograms by scripting. This will allow users to subtract a blank background run from the run of interest, for example to ensure a good baseline for quantitation purposes, or to accurately measure differences between two or more runs.

You will need to select the folder containing the datasets (background) and the applicable path masks.

Similarly to chromatogram subtraction, there is another option for UV subtraction. So you will subtract a background UV chromatogram from the foreground one.

Selecting the 'Options' label:

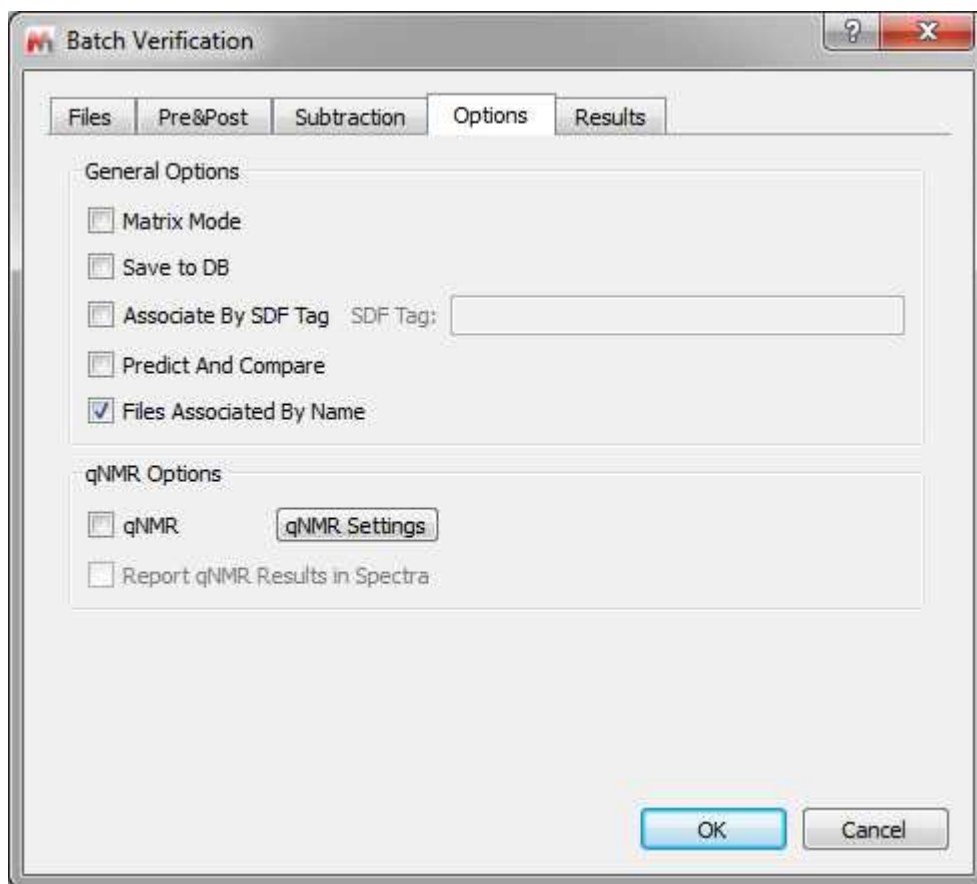

Matrix Mode: Running in this mode will verify every spectral set against every available molecule, generating a matrix like output with number of rows and columns equal to the number of spectral sets/molecular structures, and with each cell corresponding to a verification result.

Save to DB: When this option is activated, the script will save each spectral set and molecule with its verification results into a new record of the Mnova Spectral DB.

Files Associated by name: The script has the options to run spectra and molecules with the same name (therefore user should rename the mol or sdf files to the same name as the spectra) or in the same order (in which case user should make sure that the spectra and the molfiles are in the same order in their respective locations).

Predict & Compare: As with the single mode verification, this just sets the way in which the data are presented to the user after the verification has been completed. If the option is selected, the user will be presented with a stack of the experimental and the predicted ^1H spectrum, if the option is unselected the user will get presented with just the experimental spectrum.

qNMR: if the user has the [qNMR](#) module activated, he will be allowed to do quantitation as well when running the verification. it will be possible to use ERETIC/QUANTAS or PULCON

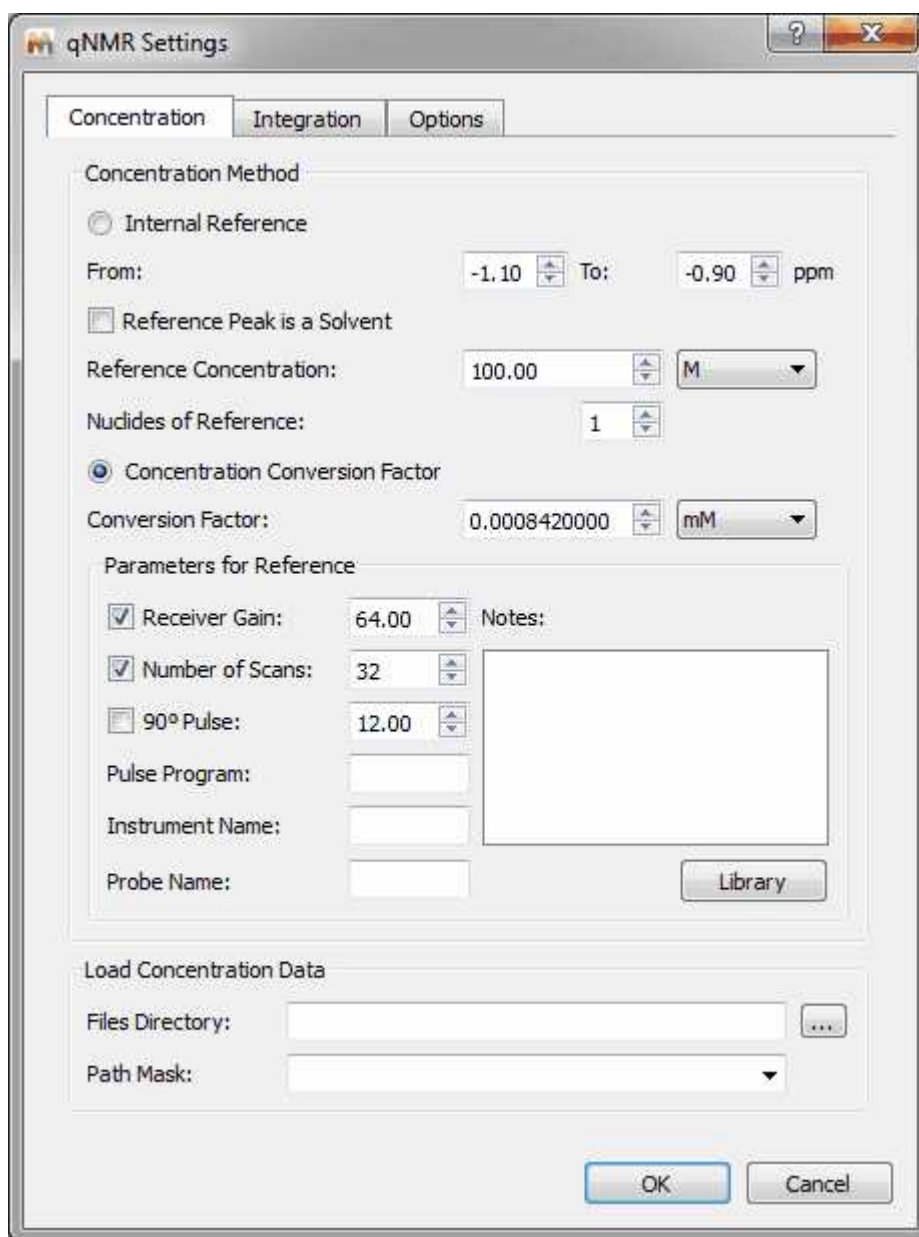

Concentration Label – Determining the concentration

Internal Reference: This allows an internal signal position to be designated, and specify its corresponding integral. The internal reference may be synthetic (ERETIC, QUANTAS) or real (residual solvent signal, TMS).

Absolute Integral Reference: This uses a “Concentration Conversion Factor” to convert an Absolute Integral/nuclide to concentration. (Equivalent to PULCON).

NMR Parameters: the user will be able to specify the acquisition parameters used to derive the “Concentration conversion Factor”. Any change to pw90, receiver gain, or number of scans will be corrected if they are specified here.

Load concentration Data: Allows the PULCON factor to be read from a file. We will need to handle the factor that converts Bruker’s PULCON to MNova conversion factor.

Integration Method

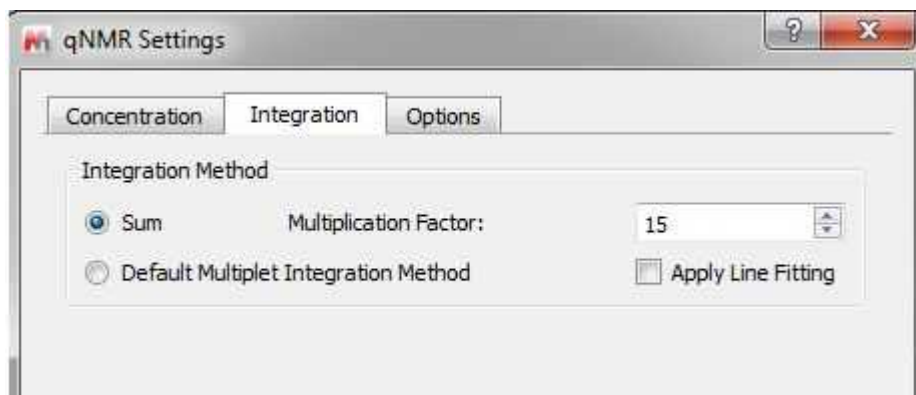

Sum: This will do a classical “sum” integration. To account to varying peak line-widths, we determine the line-widths and multiply this by the Multiplication Factor. This is used to always set sensible integral limits for a multiplet.

Multiplet Integration Method: by default it would be 'Peaks' (you can change it in the Multiplet Options).

Apply line fitting: This is an add-on to GSD in cases where it doesn't perform as well as you like. The idea is to first do GSD to locate peaks, and improve the integrals by doing full line fitting of each peak in each multiplet. (This takes a little longer to compute).

Options

From here you can specify the default number of multiplets used to calculate the average concentration, and which average calculation method to use.

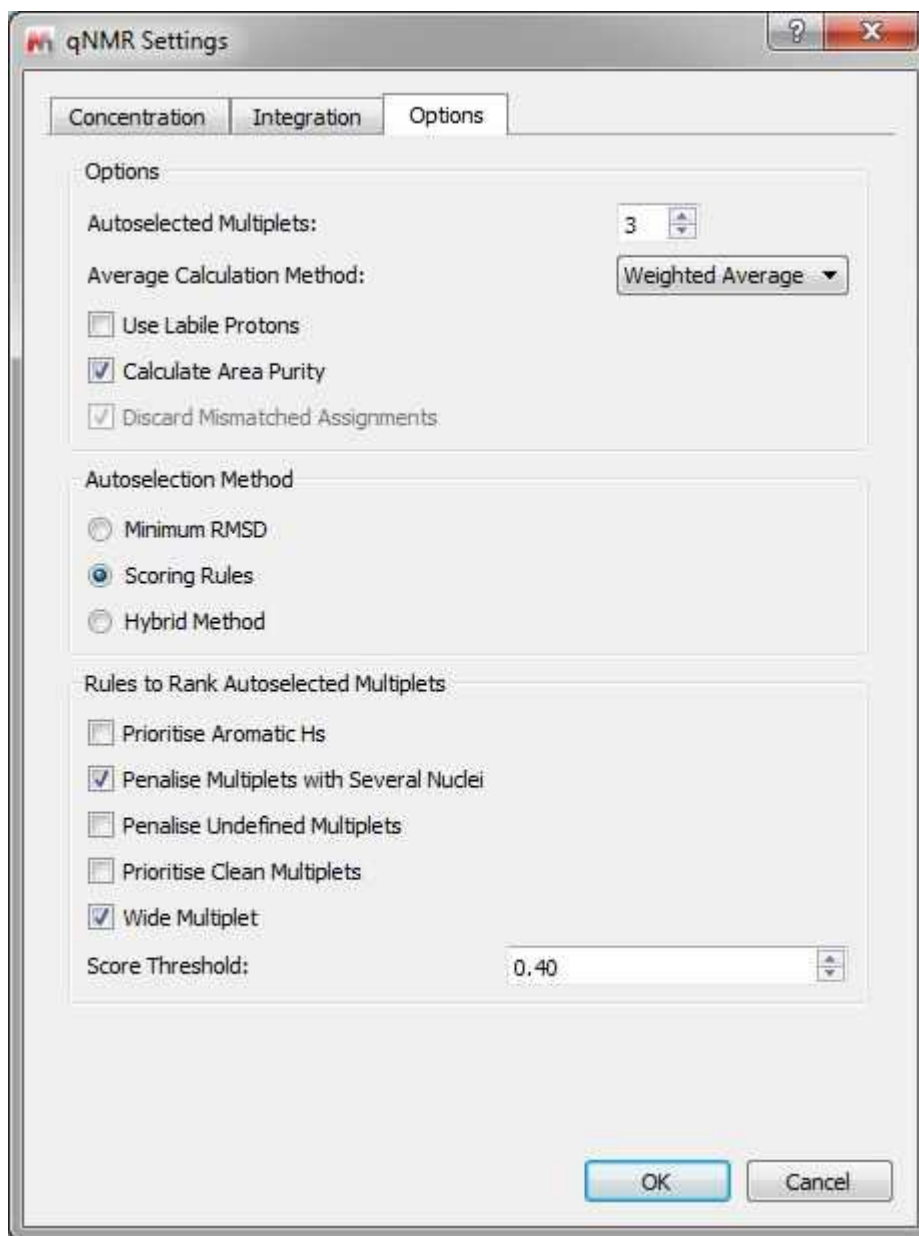

From here you will also be able to rank and prioritise multiplets as candidates for use in determining the concentration. They are based on empirical rules and penalties to give you the best chance of using a multiplet that is not “contaminated” with impurity peaks. (Labiles should almost always be excluded as they usually underintegrate).

In the result dialog box, you will find additional options to save the verification results

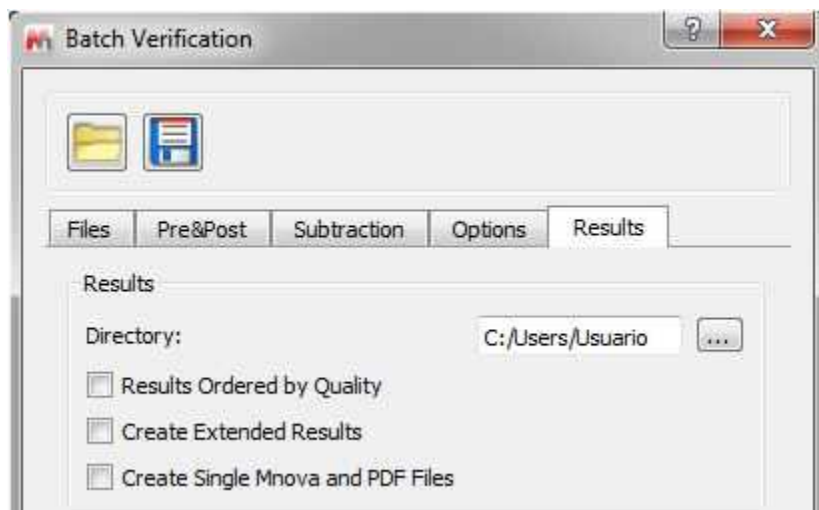

The user can enter a folder location where results should be saved and decide whether, in addition to standard output, Mnova files and PDFs should also be saved (this will be an Mnova file and a PDF for each verification set).

Ordered results will order the results from best verification quality to worse, whilst if this box is unticked, the results will list spectra/molecule pairs in the same order as they are in the folders they are being picked up from to run the verification.

The verification script will also generate a log file with some basic information about the verification that has been run (time it was run, number of datasets, etc.) and a summary html file which can be opened in any web browser and which will contain a table showing all the verification results for all the sets, as well as links to the documents in case the user needs to interrogate the data further or look at the detail behind, for example, unexpected failures.

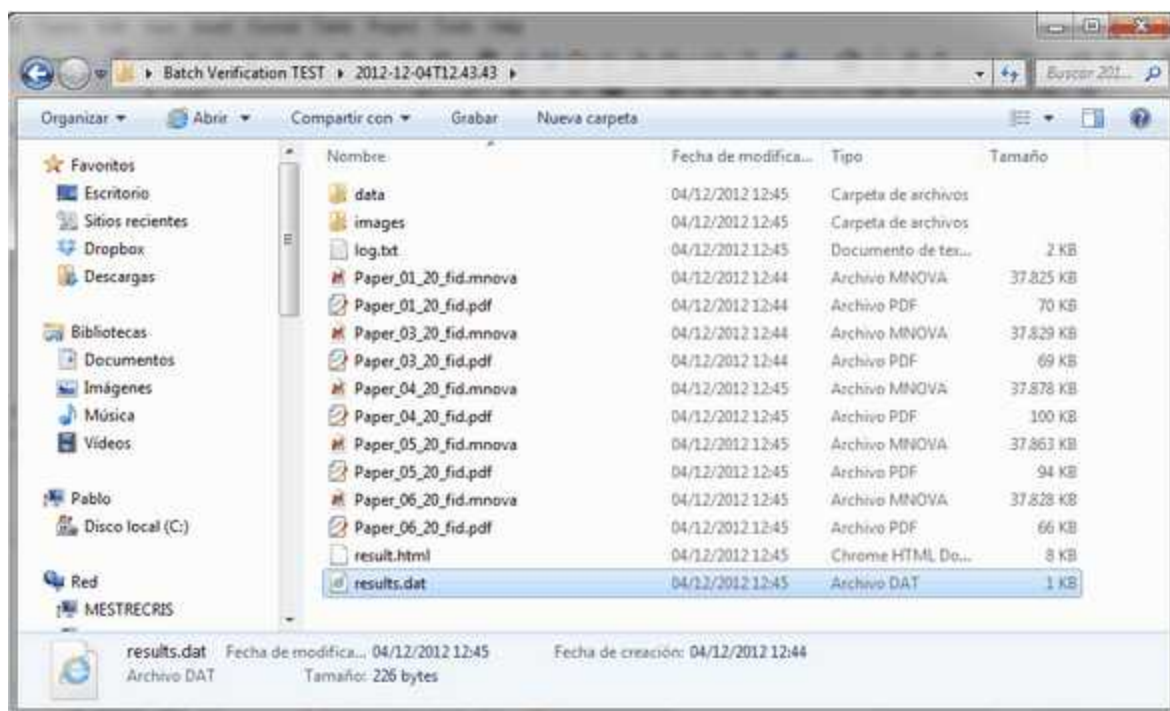

For results interrogation and to gain understanding of the results, user should open the 'result' html

file, with any web browser. This file will present, in one single view:

- Some basic verification parameters (time run, type of data)
- A well plate with the summary results for all datasets
- An extended table with the final result for each dataset as well as all the individual test results for each individual dataset
- Links to the .mnova and .pdf files generated, as well as to original files (fid, mol, etc.) to allow user to quickly drill into specific results which need to be check or looked at further.

The screenshot displays the 'Batch Verification' results page. At the top, there is a 'Parameters' table with fields like 'Verification Type', 'Results Director', 'Start Date', and 'Completed On'. Below this is a 'Results Well Plate' represented as a heatmap. The 'Detailed Results Table' follows, with columns for various quality and significance metrics. The table rows are color-coded (green, yellow, orange, red) based on these metrics. At the end of each row in the detailed table, there are links to PDF, Mnova files, and image files. Annotations with arrows identify these key components of the interface.

You will also obtain a results.dat file which can be opened with the Verify viewer. Clicking on any row or any cell of the well plate will display the applicable dataset in your spectral window:

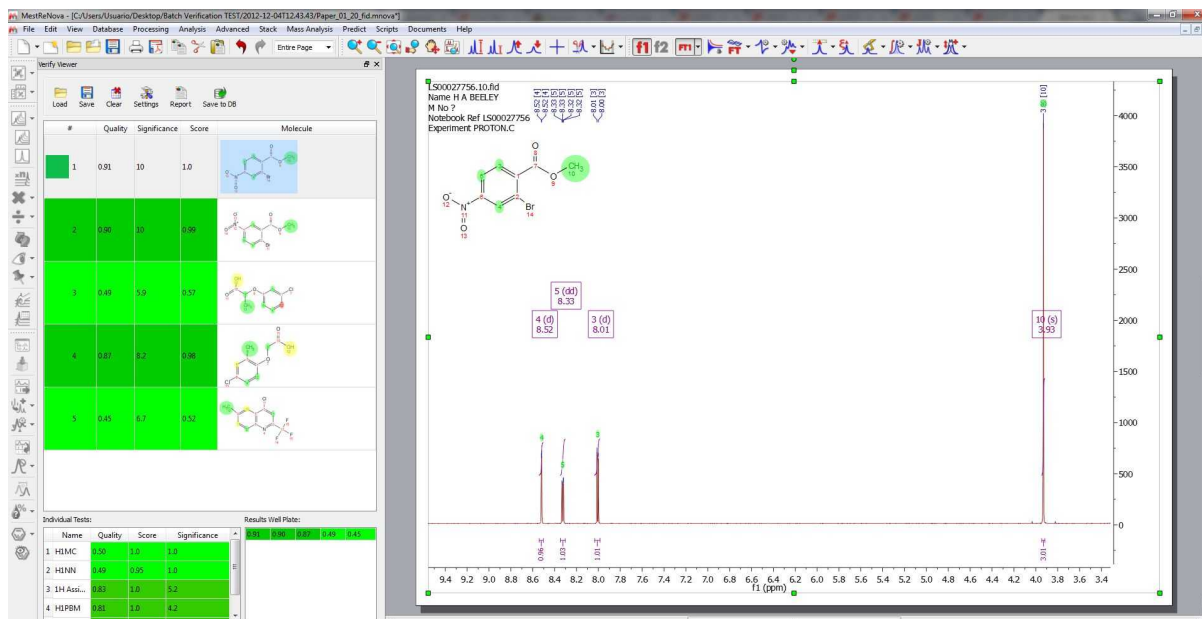

9.7 Molecules Editor

Mnova incorporates a basic 'Molecules Editor' which will be improved in the forthcoming versions of the software. This editor includes a powerful toolbar to draw your molecules:



The Drawing mode will allow you to draw a Carbon on your spectral window just by clicking on any empty field. Clicking on any existing atom will add an additional carbon. If you click on a single bond, you will get a double bond (clicking on a double bond will draw a triple bond).

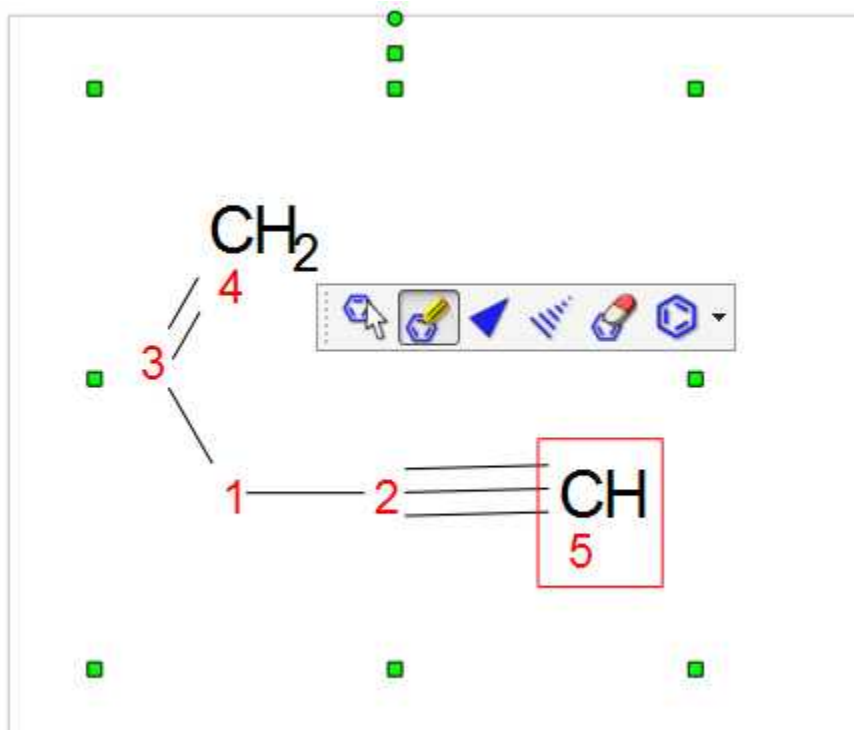

This mode will allow you to move an atom or a bond just by clicking&dragging. If you double click on an atom, the 'Edit Atom Data' dialog will be displayed. From here you will be able to change the atom label (from C to O, for example). See more [here](#).

Property	Value
1 Number	1
2 Label Format	{atomNum}
3 Annotation	
4 Color	
5 Highlight Color	
6 Atom Label	O

You can also change the symbol just by hovering the mouse over the atom and typing the applicable letter (this tool works only for one-letter elements such as C, P, N, O...).

When you select an atom, move it over another one and release the mouse button, only the last atom will stay (except when the first selected atom is non-carbon and the second atom is carbon).



Use these buttons to draw stereobonds.



Use this button to delete an atom.

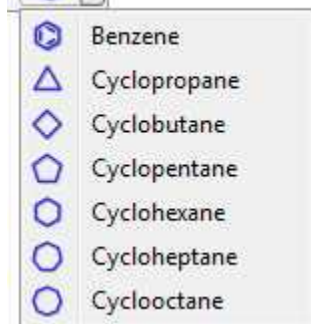

This scroll down menu, will allow you to draw cycles.

9.7.1 Molecular Structure

Mnova allows the user to import Molecular Structures, and to interact with them.

Currently, molecular structures can be imported as a **.mol**, **.cdx** or **.sdf** files by simply using the Open command (or by dragging & dropping the file to the Mnova icon or interface) exactly in the same way as this would be applied to a spectrum. Support to 'drag & drop' operations are currently limited to **ACD ChemSketch and ChemDraw**.

You can also copy structures as MDL SK format (with abbreviated groups), to do that just copy the molecular structure to the clipboard (from ChemDraw for example) and follow the menu 'Edit/Paste Special':

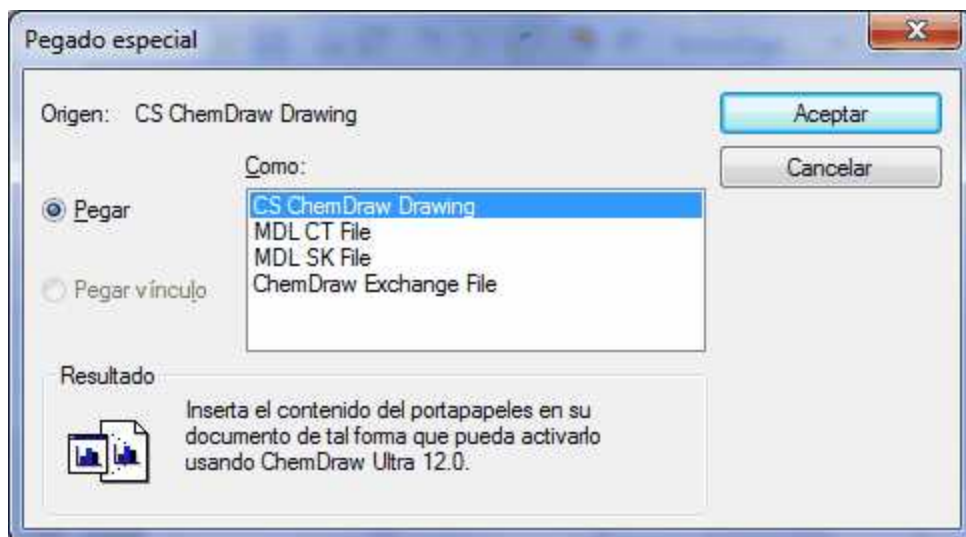

Indeed it will be possible to keep the numbering from ChemDraw or the abbreviated structures by using the 'ChemDraw Exchange file' from the dialog box above.

If you are using IsisDraw, please keep in mind that you will need to select the capability to copy your molecules as mol files in the 'Options/General Settings' menu.

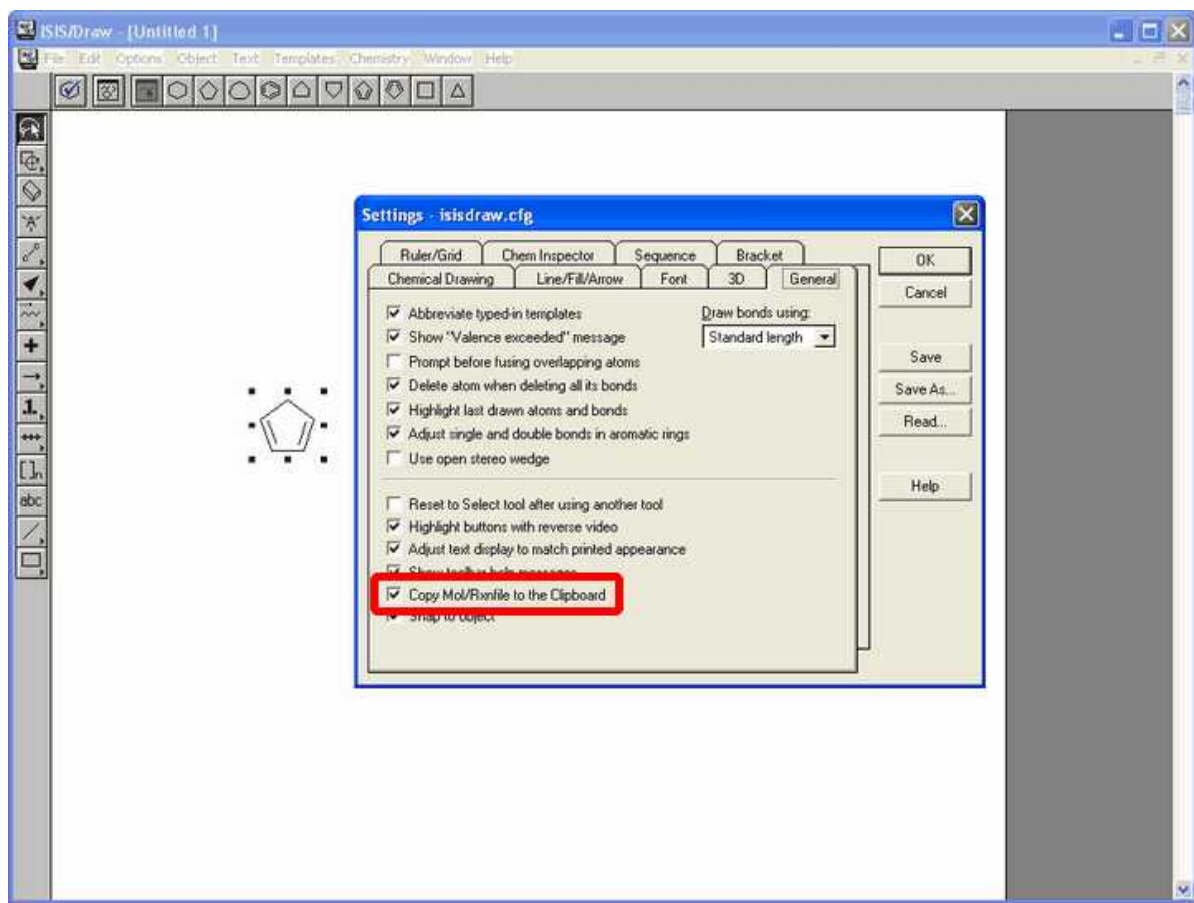

The molecular structure can be handled (resized, moved, aligned, copied, pasted, etc) exactly in the same way as all other Mnova objects. Molecular structures can be imported in a separate page or into a page already occupied by another object, such as for example its applicable spectrum.

The first thing you will notice when interacting with molecular structures, is the fact that atoms will become highlighted in a red transparent box when the mouse hovers over them. Clicking on an specific atom will make it the active atom and highlight in a red box with pink background, as can be seen in the figure below. This atom selection will become essential when interacting with the molecule, as will be explained in the following chapters.

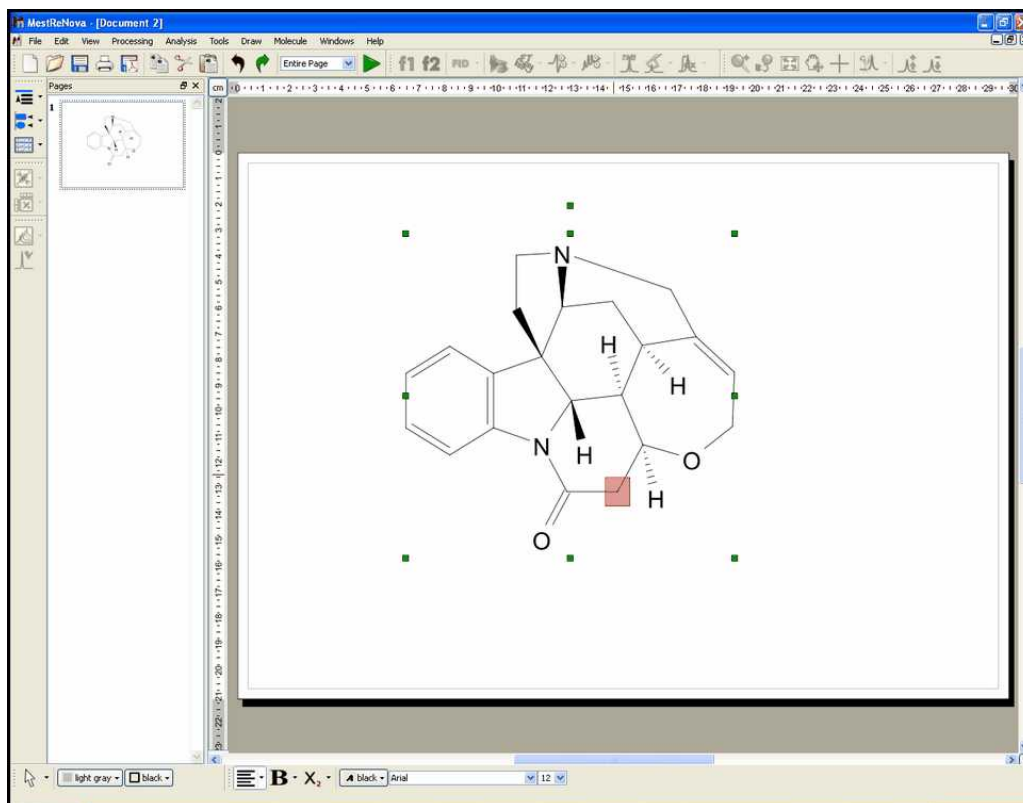

Mnova will allow you to customize the appearance of the molecule, by using the object 'Properties' dialog box. This box can be accessed by double clicking on the molecule, or by right clicking and then scrolling down to 'Properties'.

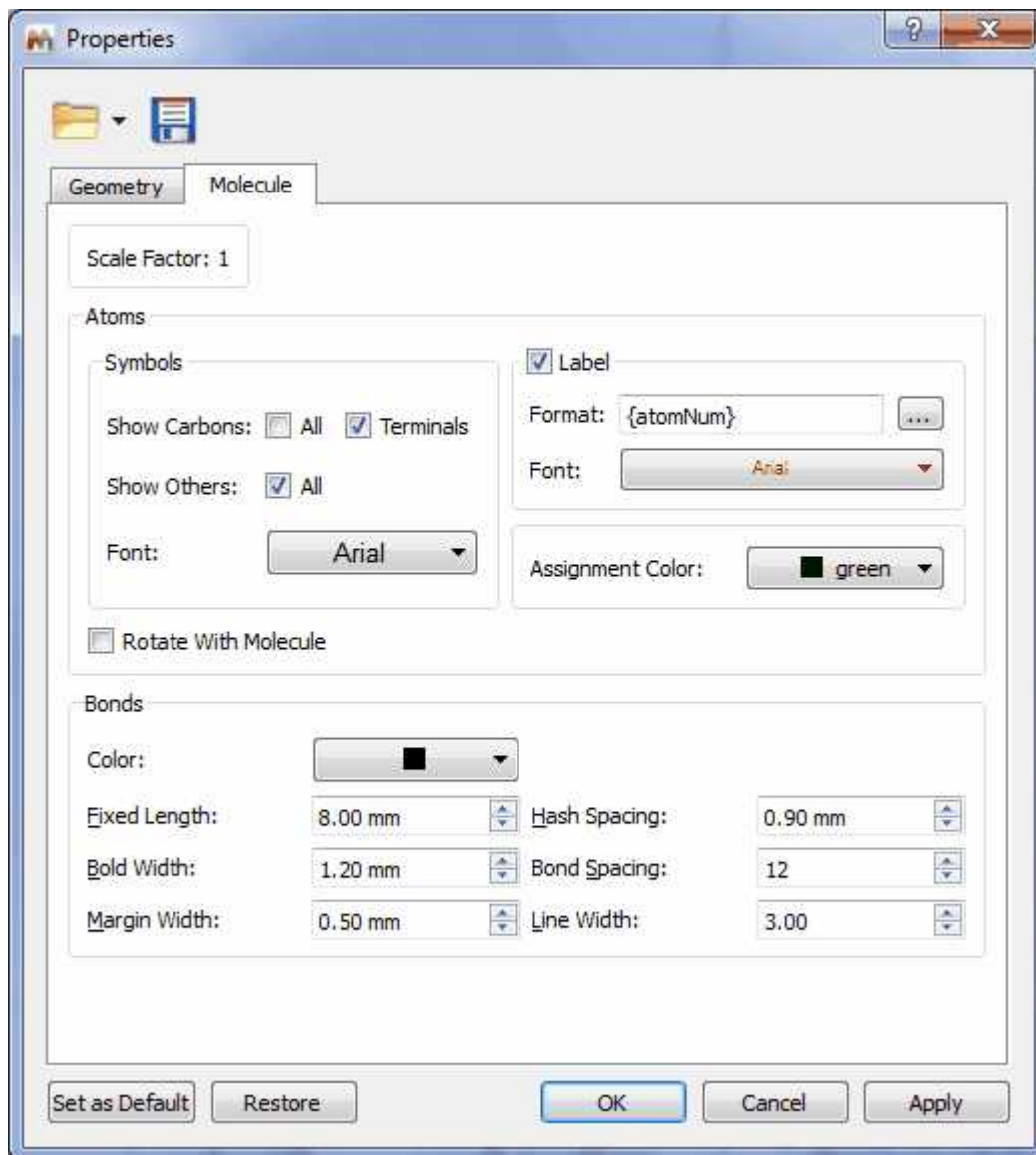

The 'Properties' dialog box will allow you to customize the size of the molecule, its angle with respect to the paper (geometry properties) and all representation properties, such as whether or not to show explicit carbon and hydrogen atoms, whether to show atom numbers, the length and spacing of bonds, etc. It is therefore possible to achieve many different representations of the same molecule, as the figure below shows.

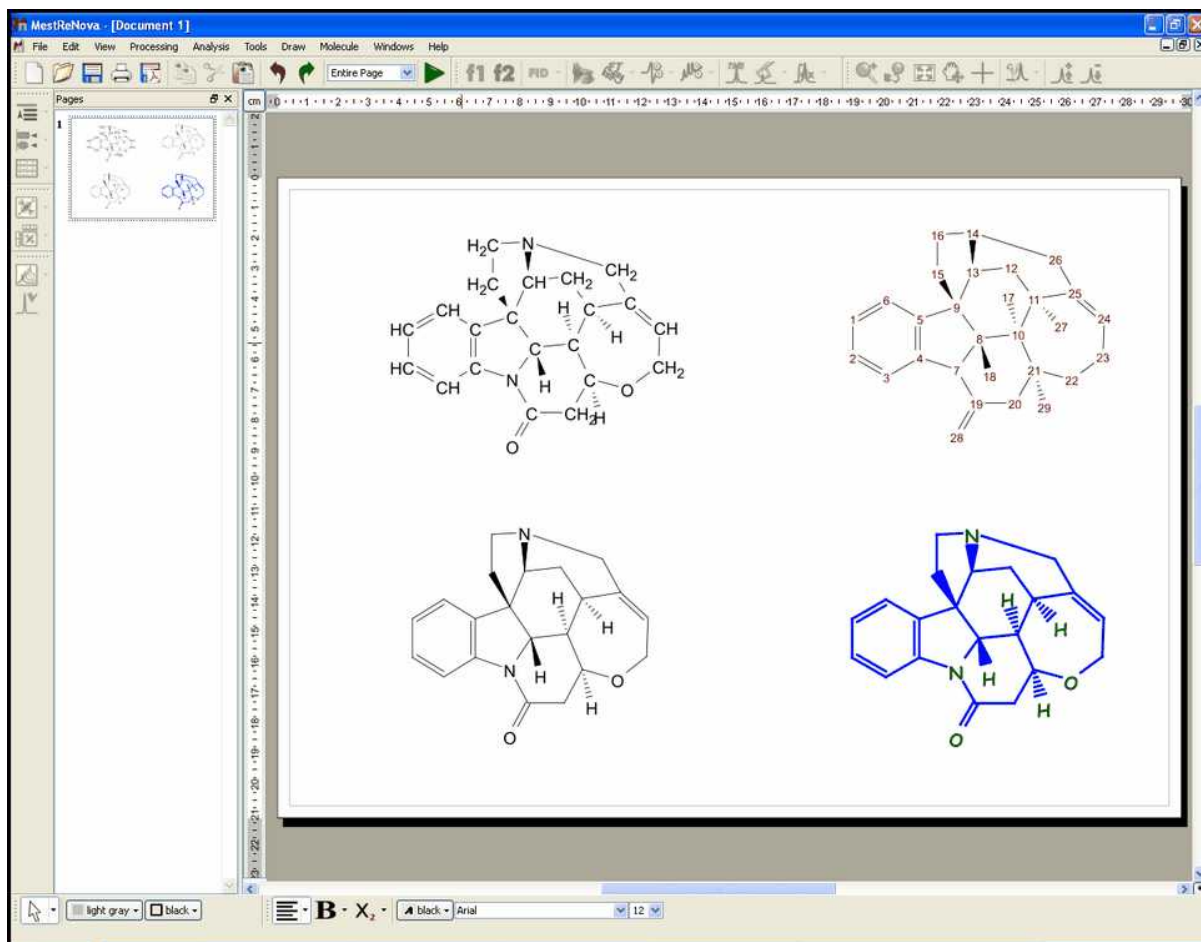

It is also possible to customize the appearance of all the atom labels of the molecule, just by double clicking on this button  in order to display the 'Macro Editor' dialog box. From here you can add information about 'annotations', 'atom number', 'assignments', 'predicted chemical shift', etc.

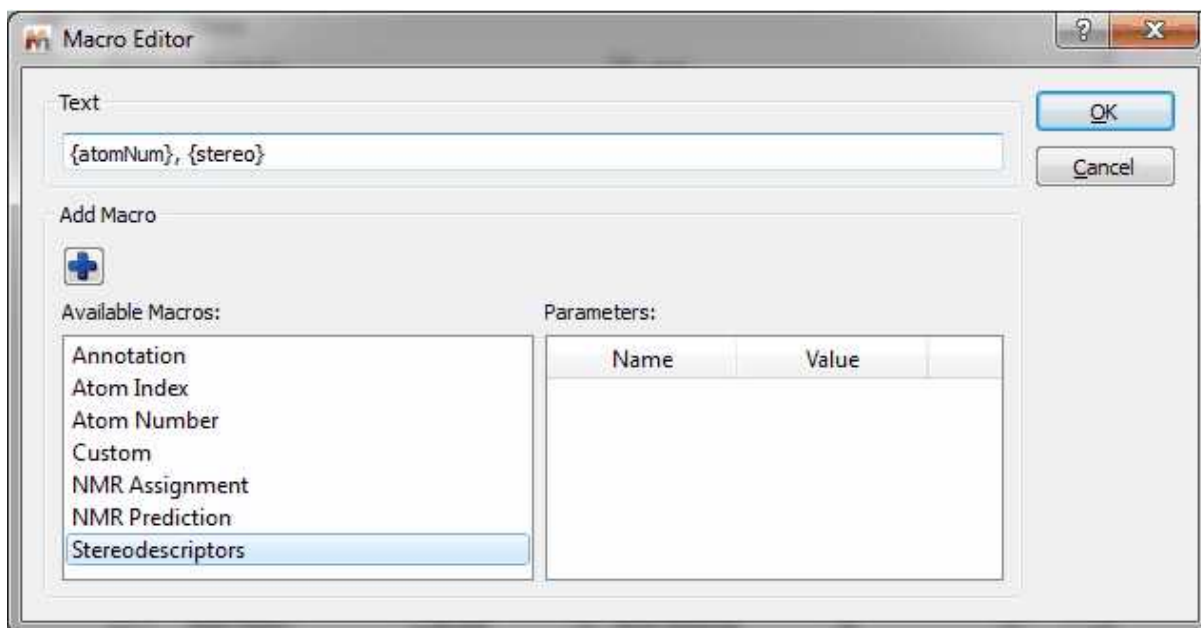

In the example below, it is shown an atom label which contains information about the 'atom number' and the 'predicted chemical shift':

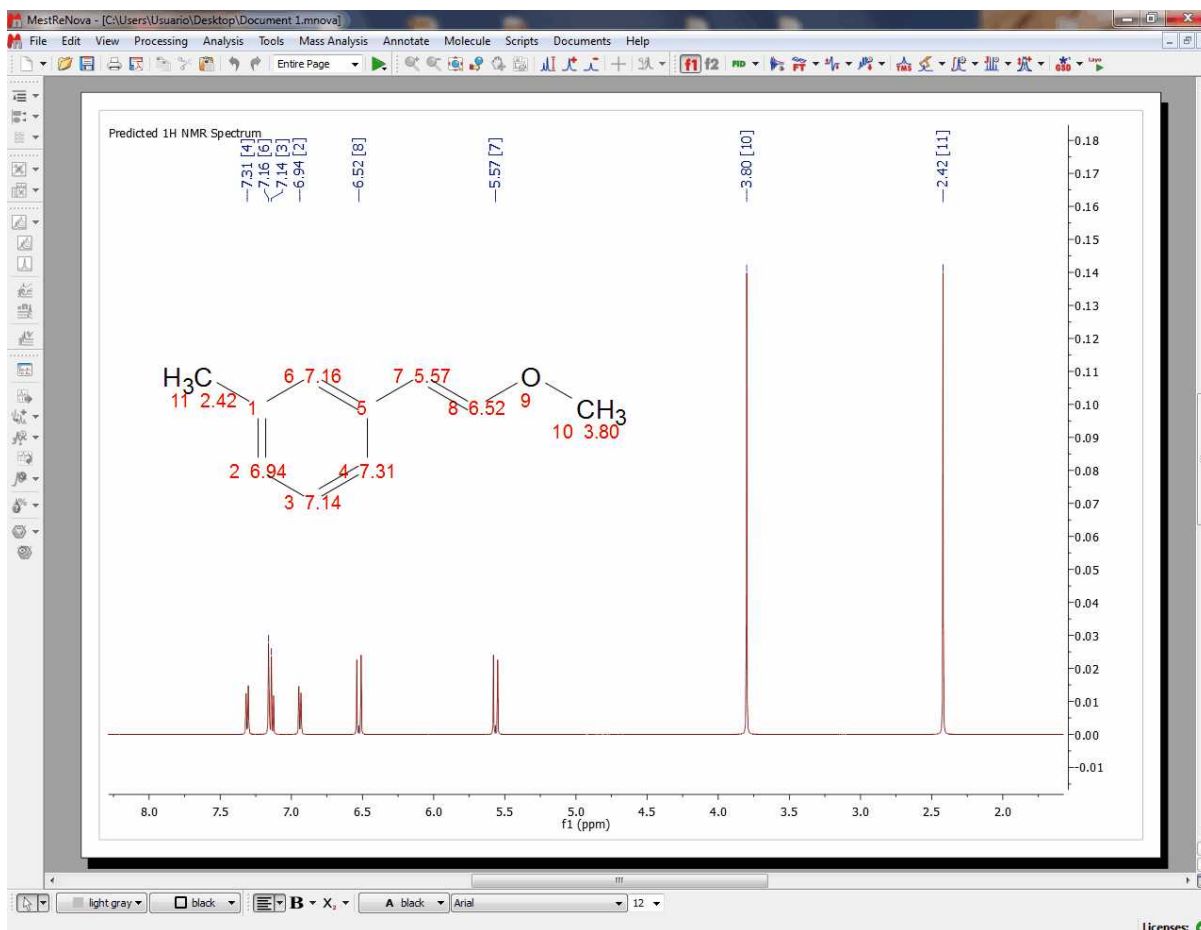

It is also possible to edit the label of each atom, just by double clicking on the applicable atom (even from the molecular table) in order to display the 'Edit Atom Data' dialog box:

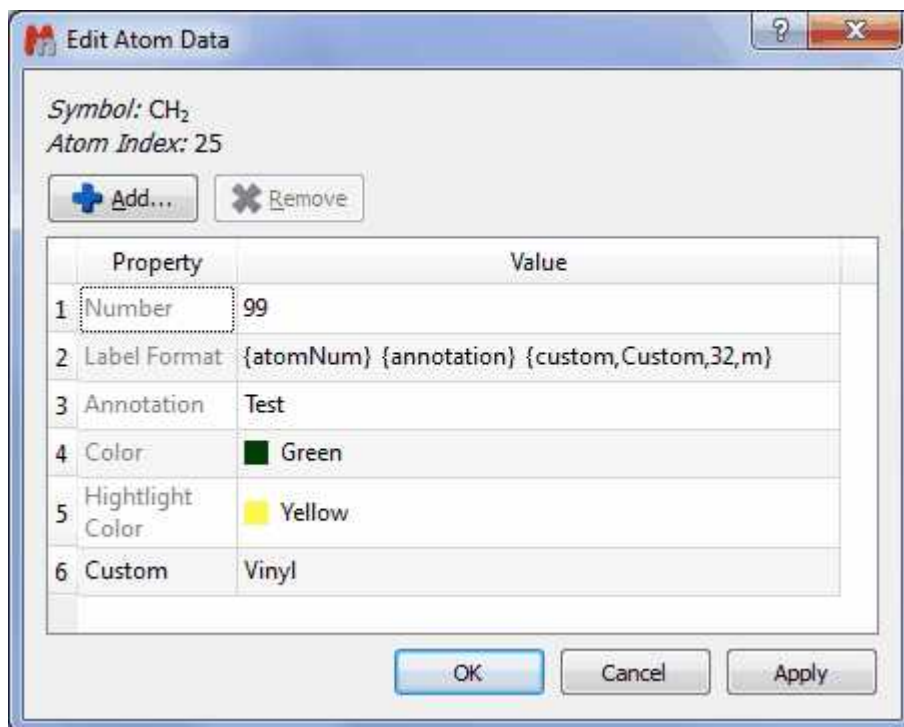

From here it will be possible to add a macro for the atom label (as it is shown a few lines above) in order to include information such as 'annotations', 'atom number', 'assignments', 'predicted chemical shifts' etc...

You can type any annotation, such a comment or a different numbering (just by changing the value of the 'Number' cell). It is also possible to change the color of the atom or of the highlight or even to add

any property just by clicking on the this button .

In that case we have changed the number to the atom 25 (the new number is 99) and added a macro to show the 'Atom Number', the 'Annotation' (Test) and the 'Custom Property' (Vinyl), changing the color to green with a yellow highlight:

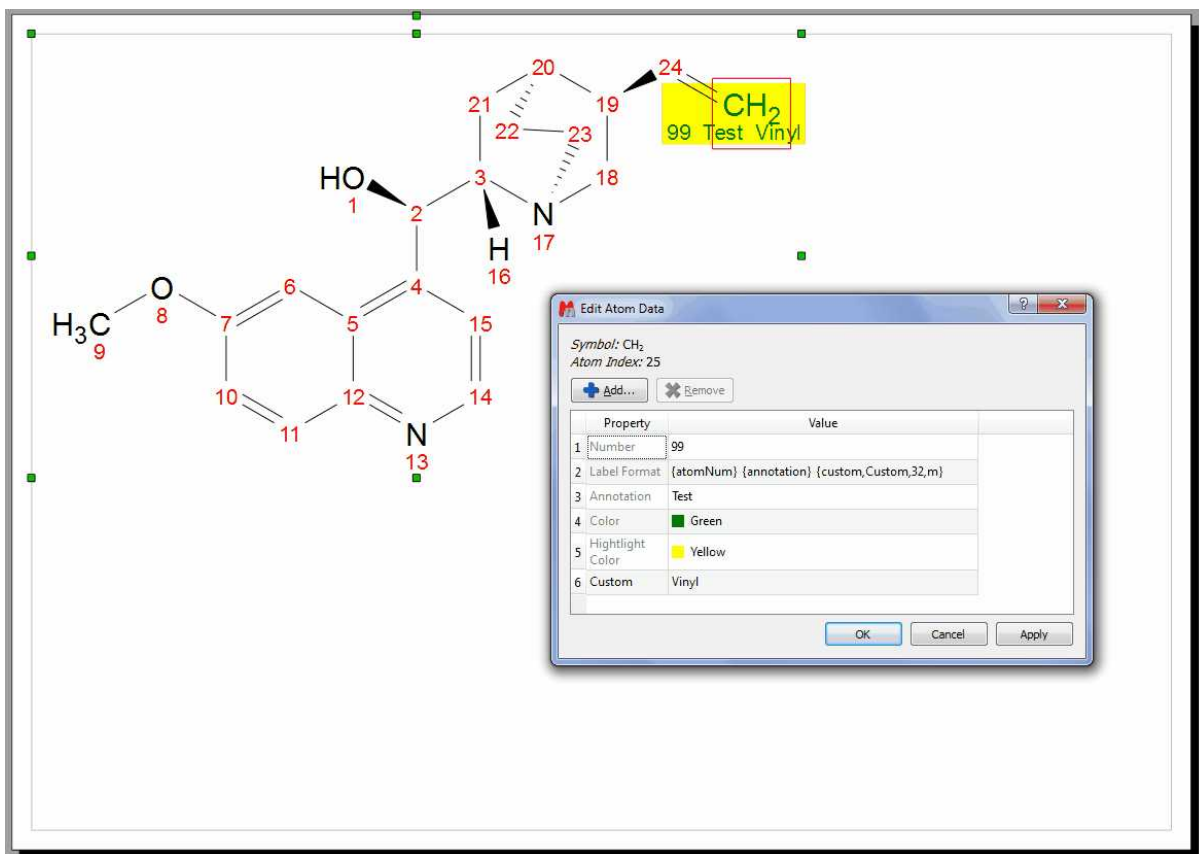

The new numbering can be exported in a mol file and you can 'import molecule styles' (for the 'Edit/Paste Special' feature) by selecting the applicable option in the [Edit/Preferences/Molecules](#) menu.

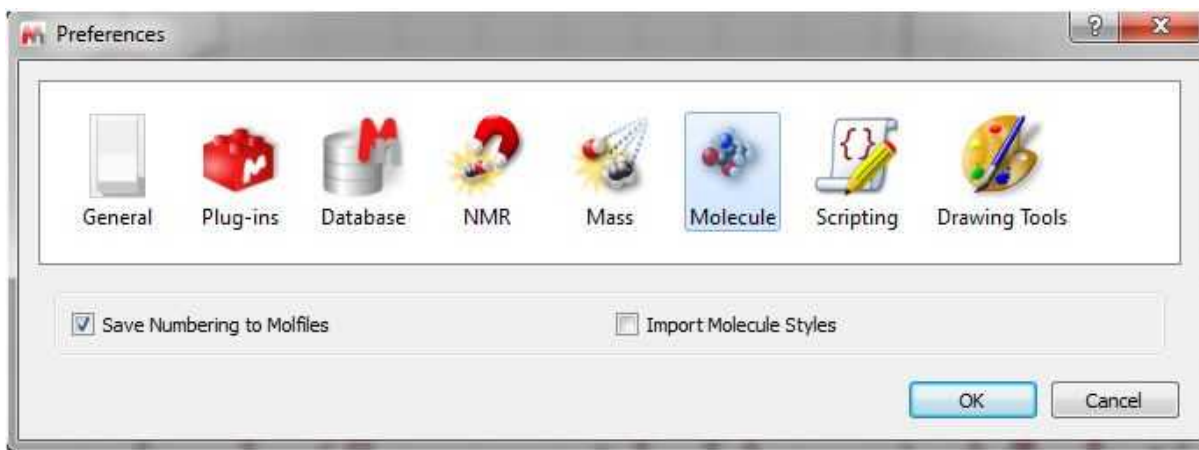

Right clicking on any atom number of the molecular structure will display a context menu which will allow you to show the assignments, prediction, number, annotations or stereodescriptors as atom labels:

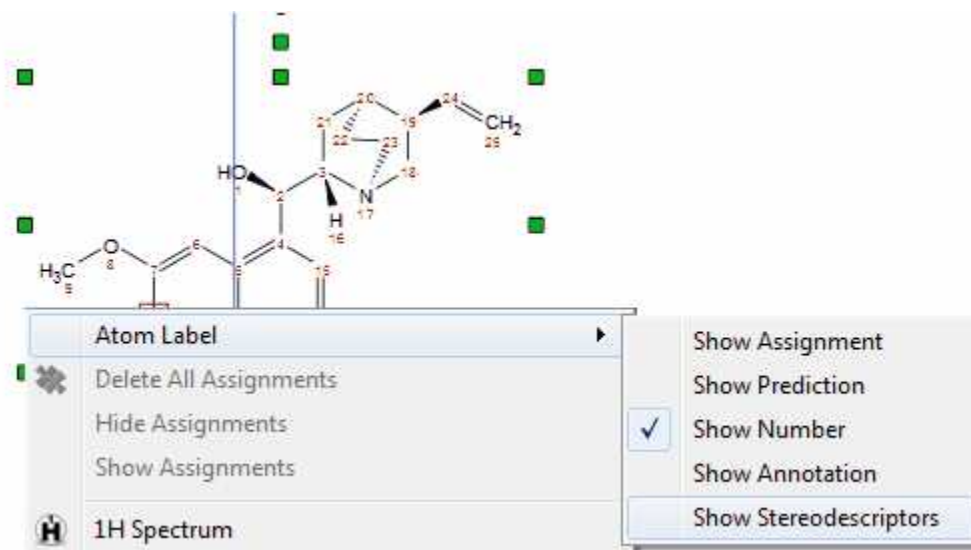

9.7.1.1 Compounds Table

This table will show all the molecules present in the document, with information about the chemical formula and molecular weight, name, label, description, color, etc.

Compounds								
Report Add Delete Setup								
	Molecule	Molecular Formula	Average Mass	oisotopic	Name	Label	Description	Color
1		C ₄ H ₈ O ₂	88.11	88.05	Ethyl Acetate	Ethyl Acetate	Impurity: residual solvent	Orangered
2		C ₂₀ H ₂₄ N ₂ O ₂	324.42	324.18	Quinine	Quinine	Main compound	Dodgerblue

You can copy any molecule from this table to another page just by selecting it and clicking on the 'Report' button. Please bear in mind that the information about predictions and assignments is linked to the molecule and will be kept after having pasted it to another slide.

Clicking on the 'Add' button of the table, will allow you to add a new 'unknown structure', very useful to start assignments of unknown compounds.

Compounds								
	Molecule	Molecular Formula	Average Mass	Monoisotopic Mass	Name	Label	Description	Color
1		C ₄ H ₈ O ₂	88.11	88.05	Ethyl Acetate	Ethyl Acetate	Impurity: residual solvent	Orangered
2		C ₂₀ H ₂₄ N ₂ O ₂	324.42	324.18	Quinine	Quinine	Main compound	Dodgerblue
3		?	0.00	0.00	Impurity	Unknown	Unknown Impurity	Lime

9.8 How to carry out assignments?

You will find the quinine datasets in the installation folder of Mnova (under the examples/datasets folder)

It is now possible within Mnova to carry out automatic assignments (for 1H-NMR) and atom to peak assignments both to 1D and 2D spectra.

Automatic Assignment of 1H NMR Spectra has been a pipedream for many years, especially in the organic chemistry community. In spite of successful applications of computer algorithms for the automation of the processing and analysis of NMR spectra, fast and robust unsupervised assignment of 1H spectra of small molecules has so far been a discouraging endeavor.

Mnova provides a very simple interface to automatically assign your molecule (*a license of the prediction plugin is also needed*). Just load your 1H-NMR spectrum with the applicable molecular structure and follow the menu 'Analysis/Auto Assignments' (you can also load your HSQC in the same document, to increase the quality of the assignments):

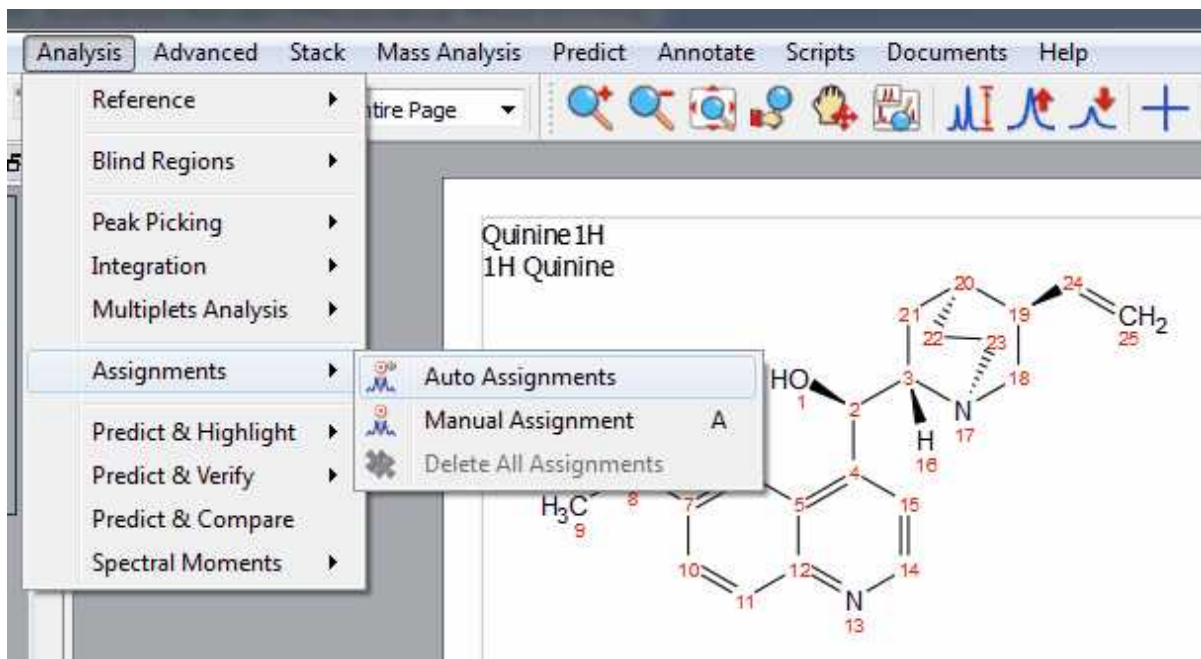

Mnova will automatically run a multiplet analysis and will fully assign your spectrum with the applicable molecular structure. The multiplet boxes will be renamed with the corresponding atom number of the molecule and you will get an assignment label with the atom number over the applicable peak. In addition, hovering the mouse over the atom will highlight the applicable signal in the spectrum:

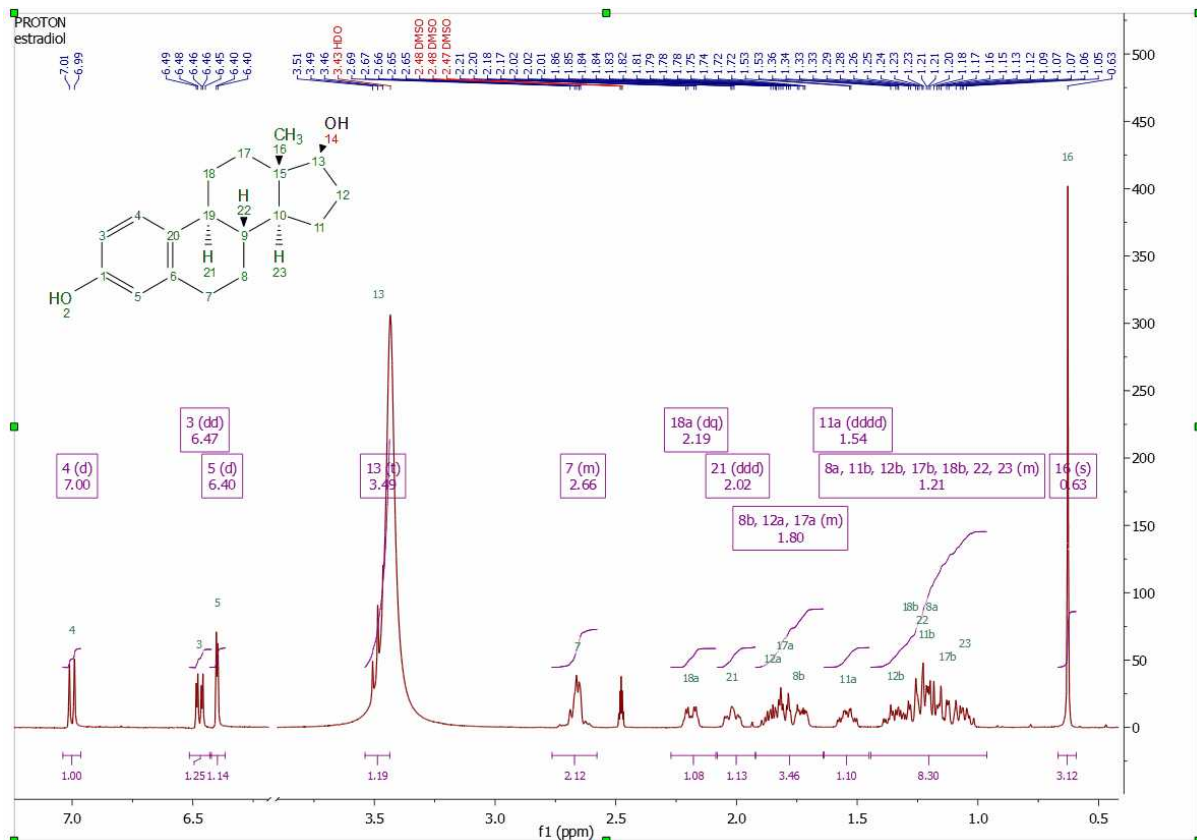

This algorithm for automatic assignment of ^1H NMR spectra has to be understood as a quick method to generate an initial 'rough' assignment that in some cases will require manual intervention from the user to easily amend any potential incorrect auto-assignment.

It is possible that auto-assignments can assign, for example, all the protons properly except two which are swapped, as illustrated in the figure below, where assignments (3) and (6) must be swapped.

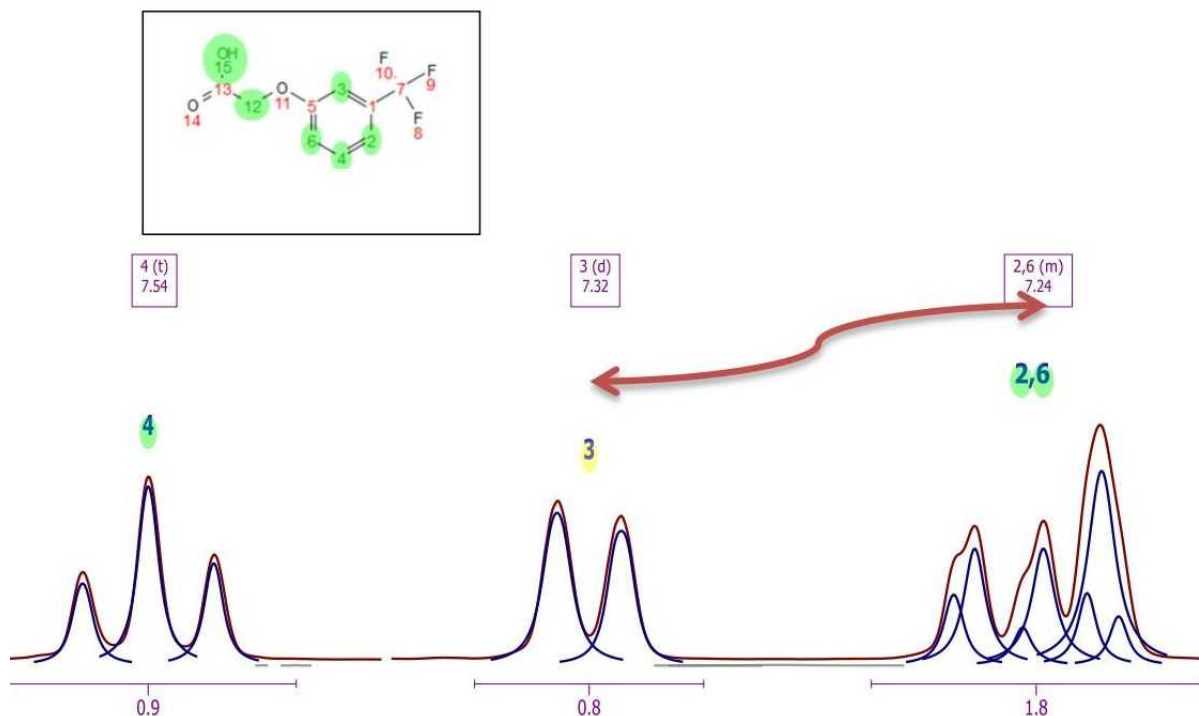

You can **swap assignments** by following the menu 'Analysis/Assignments/Swap Assignments' (shortcut: S). Then you will only need to click on one assignment label (or multiplet box) and drag and drop it to the target assignment label (or multiplet box).

If the target multiplet has more than one assignment, you will be asked for which assignment must be used for swapping.

MANUAL ASSIGNMENTS

It will be also possible to make manual assignments. **Mnova** provides a very simple interface to manually assign your molecule. Just open your NMR spectrum and load a molecule structure. Next, follow the menu 'Analysis/Assignments/Manual Assignments' (or use the shortcut 'A').

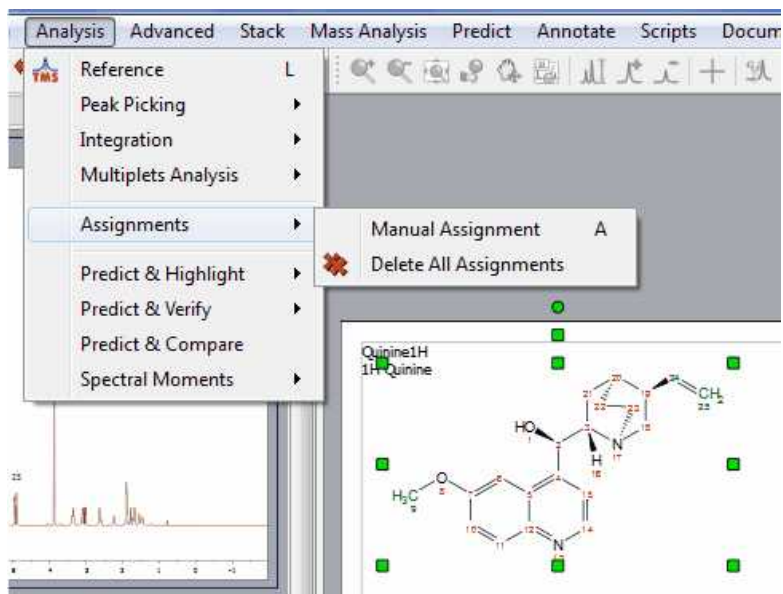

Finally, click on an atom on the molecular structure (or a spectrum region) and then release the mouse and drag it to your desired peak. Once your desired peak is highlighted on the spectrum, click on it to assign it.

NOTE: It will be possible to select several atoms at a time by holding down the 'Ctrl' key and clicking.

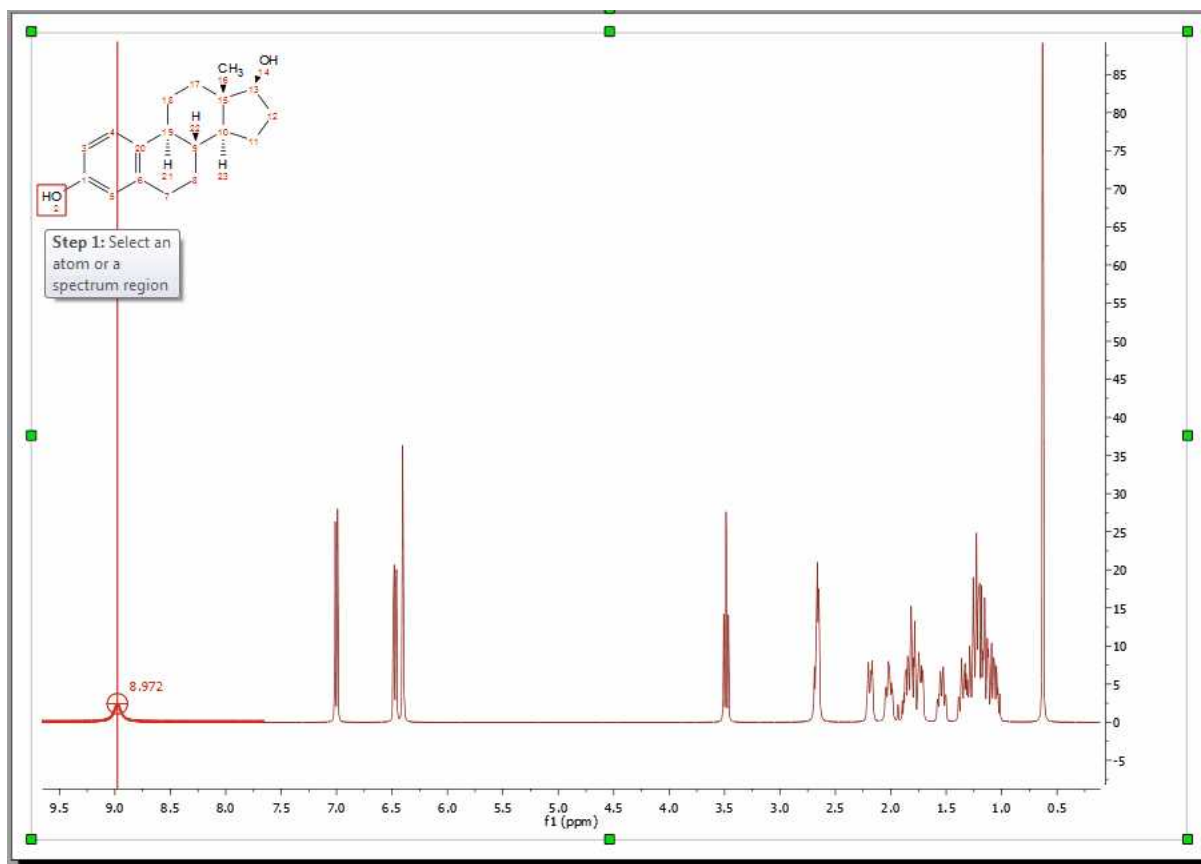

This peak will now be assigned to the atom (which will turn to green). Once the assignment has been made, you will get an atom number label on the chemical shift and hovering the mouse over the atom will highlight the applicable peak in the spectrum and hovering the mouse over the peak will highlight the corresponding atom on the molecular structure. To customize the assignments labels, click [here](#).

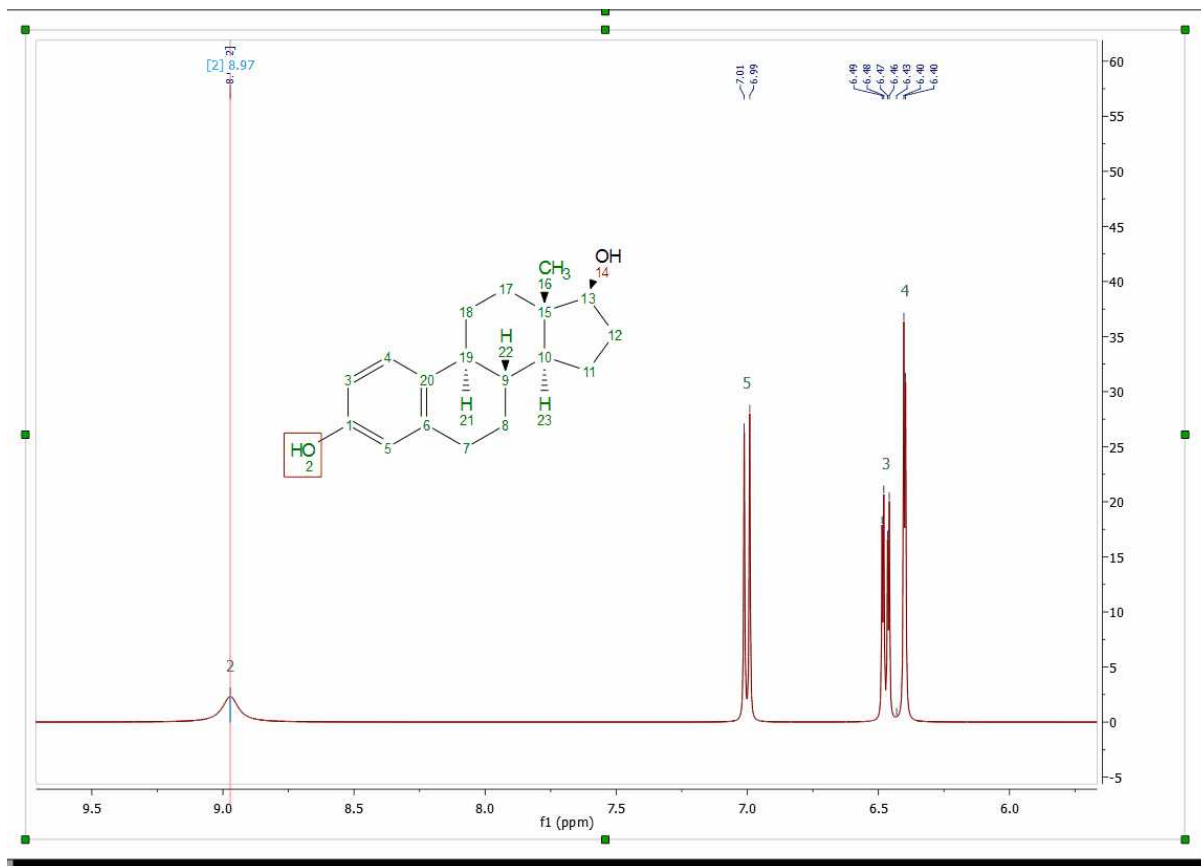

You will also notice that once the atom to peak assignment has been made, you will get an assignment peak label (over the applicable signal) with the number of the atom ([2] in the example above).

If you do not want to show the assignments labels just uncheck this option in the '[Assignments Properties](#)' dialog box

The user can also assign a region of the spectrum just by clicking, dragging and releasing the mouse over the desired region. In the example below, we have assigned a -CH₂ group, so a new window will be displayed to allow us to select which atom we want to assign, 18, 18', both (in blank) or even we can select any other annotation: 18a, 18b, cis/trans, ax/eq, α/β :

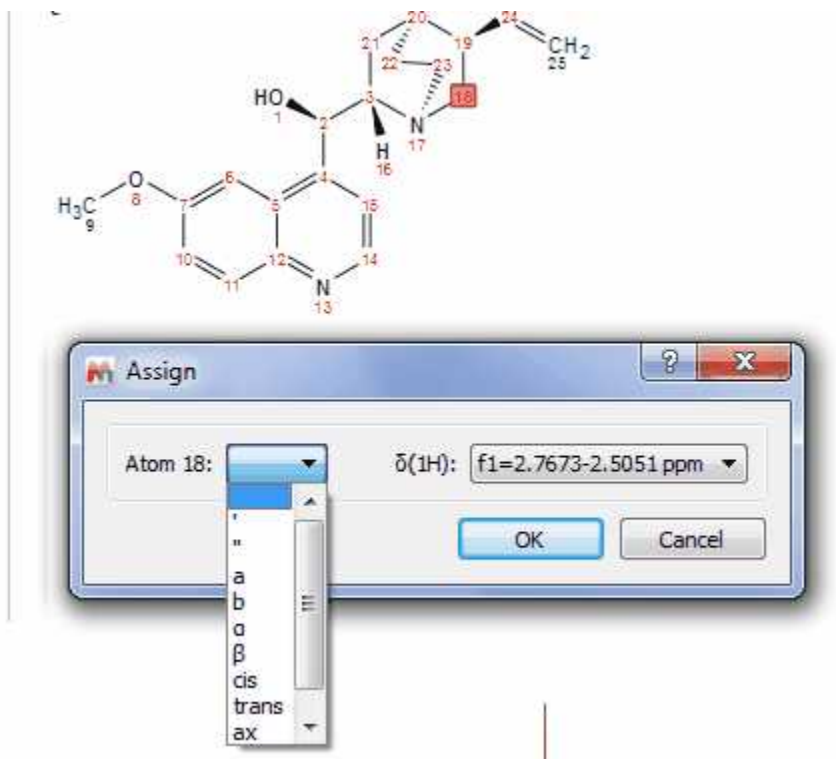

It is also possible to assign a multiplet by dragging the mouse to the '**multiplet box**' (in this case the name of the multiplet is replaced with the atom number) or to the '**integral curve**', as you can see in the picture below:

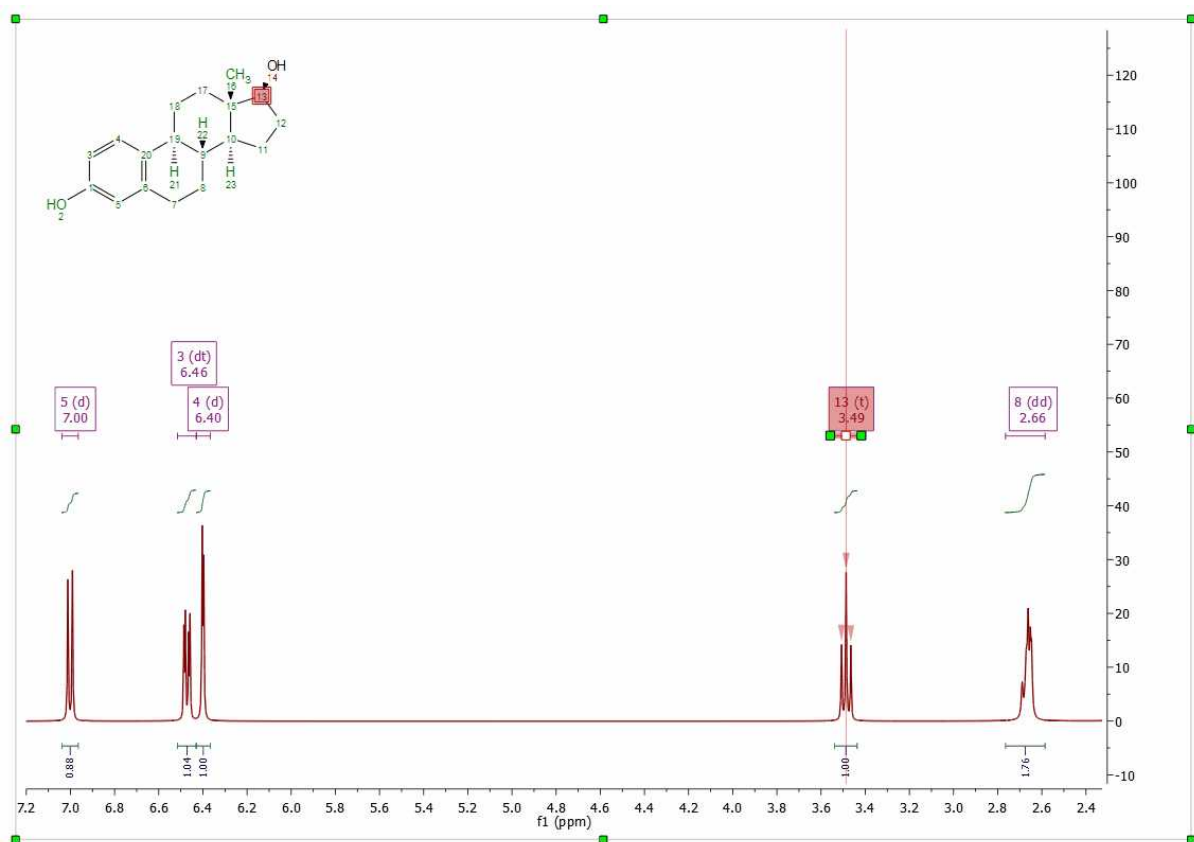

Indeed we recommend you to assign your atoms to your multiplet boxes in order to [transfer assignments through datasets](#).

It is also possible to assign a 13C-NMR of the same molecule in the same document. To do that, you can select the atoms from the Compounds Table by following the menu 'View/Tables/Compounds'.

In order to keep the assignments propagation, follow the menu 'View/Tables/Assignments' to select what datasets you want to take into account (in the example below, we have selected the 1H and the 13C NMR datasets).

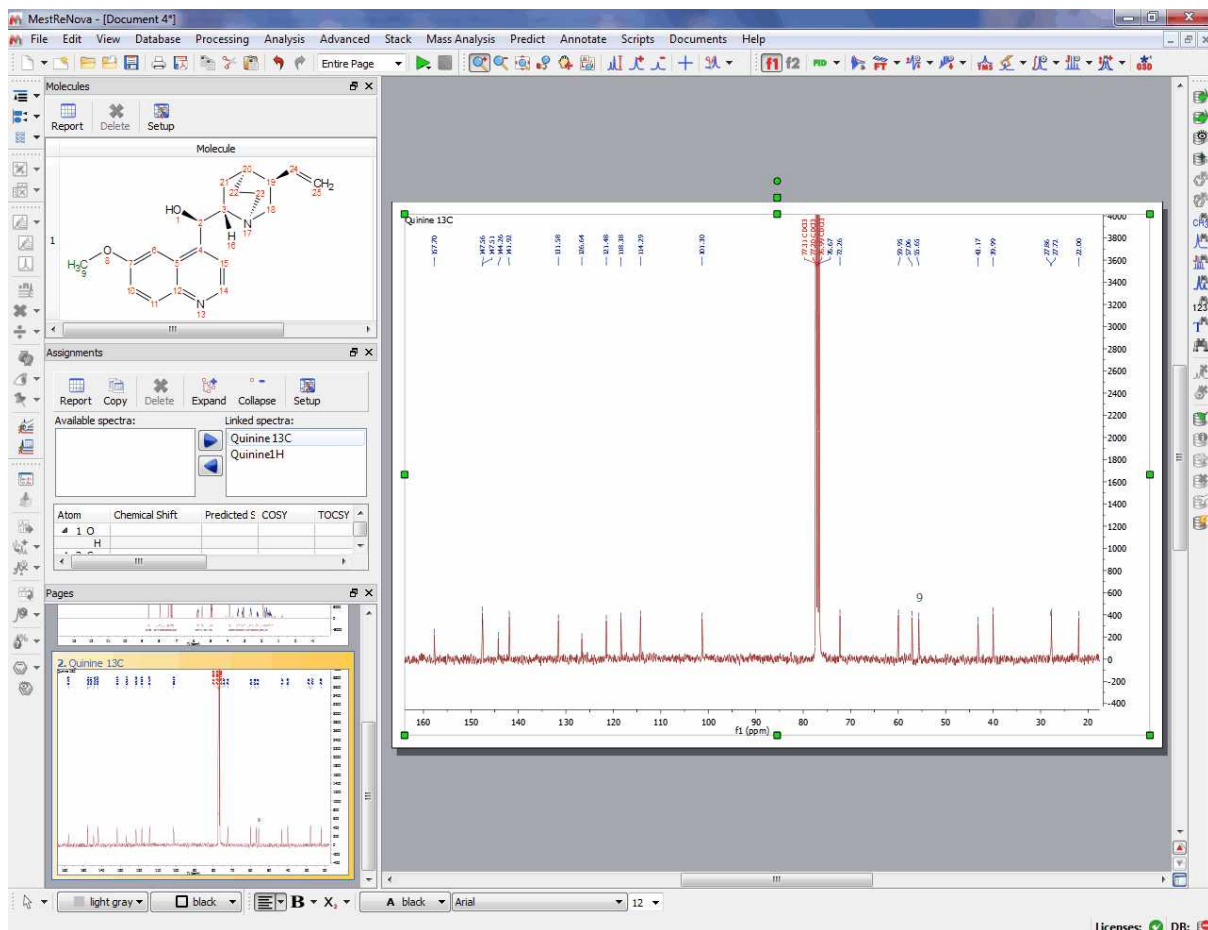

If your document has more than one molecule ([see also this tutorial](#)), it will be possible to select a different colour for the assignments of each compound by using the 'Compounds Table'. In the example below the assignments labels of the quinine appears in blue and the assignments labels of the EtOAc are green (make sure that 'Use Compound color' is checked in the Assignment Properties):

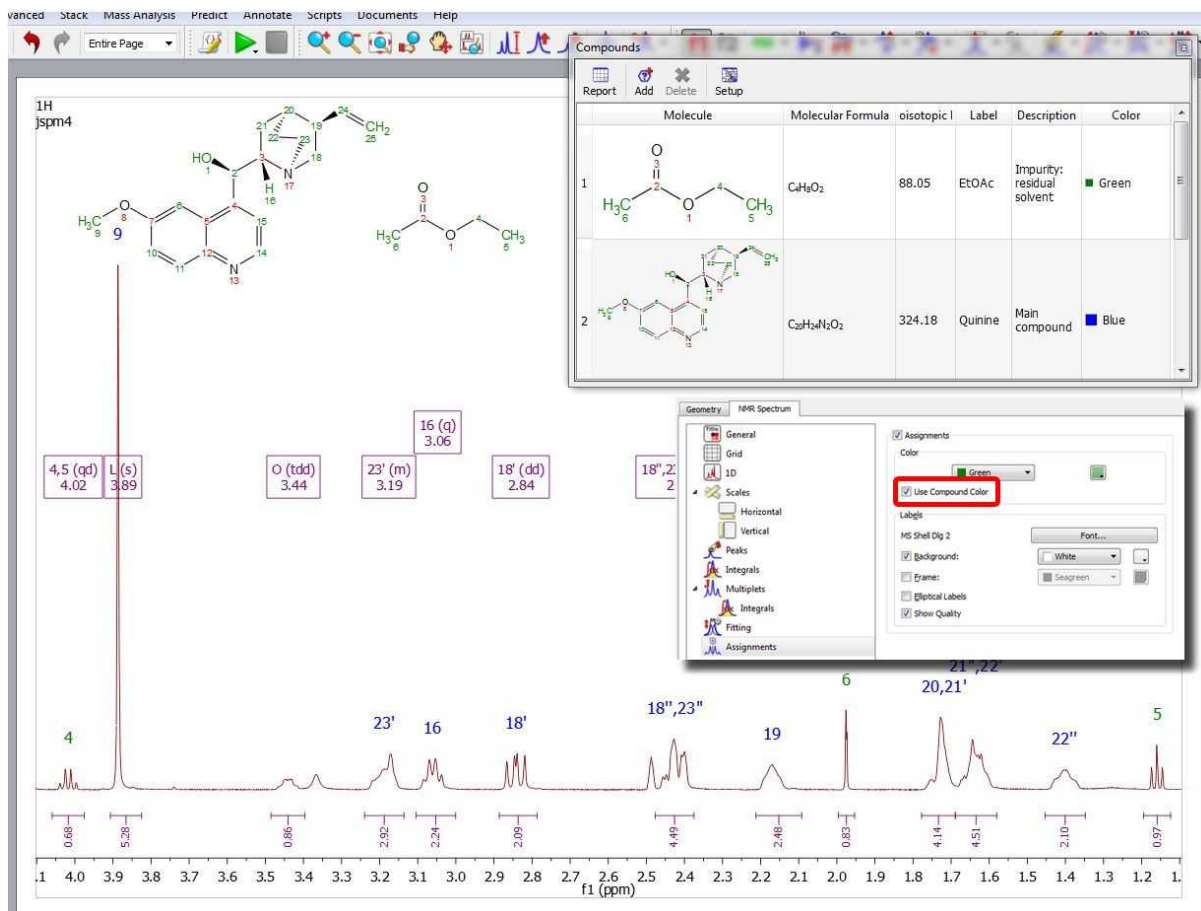

If your document contains more than one compounds, you will be able to select the compound for each peak from the Peaks Table (by clicking on the 'Set Compound' button or by double clicking on the 'Impurity/Compound' cell). The same effect will be obtained by right clicking on the Peak label and selecting 'Set Peak Compound' (please make sure that the 'Use Curve Color' box is checked in the 'Peaks Properties'):

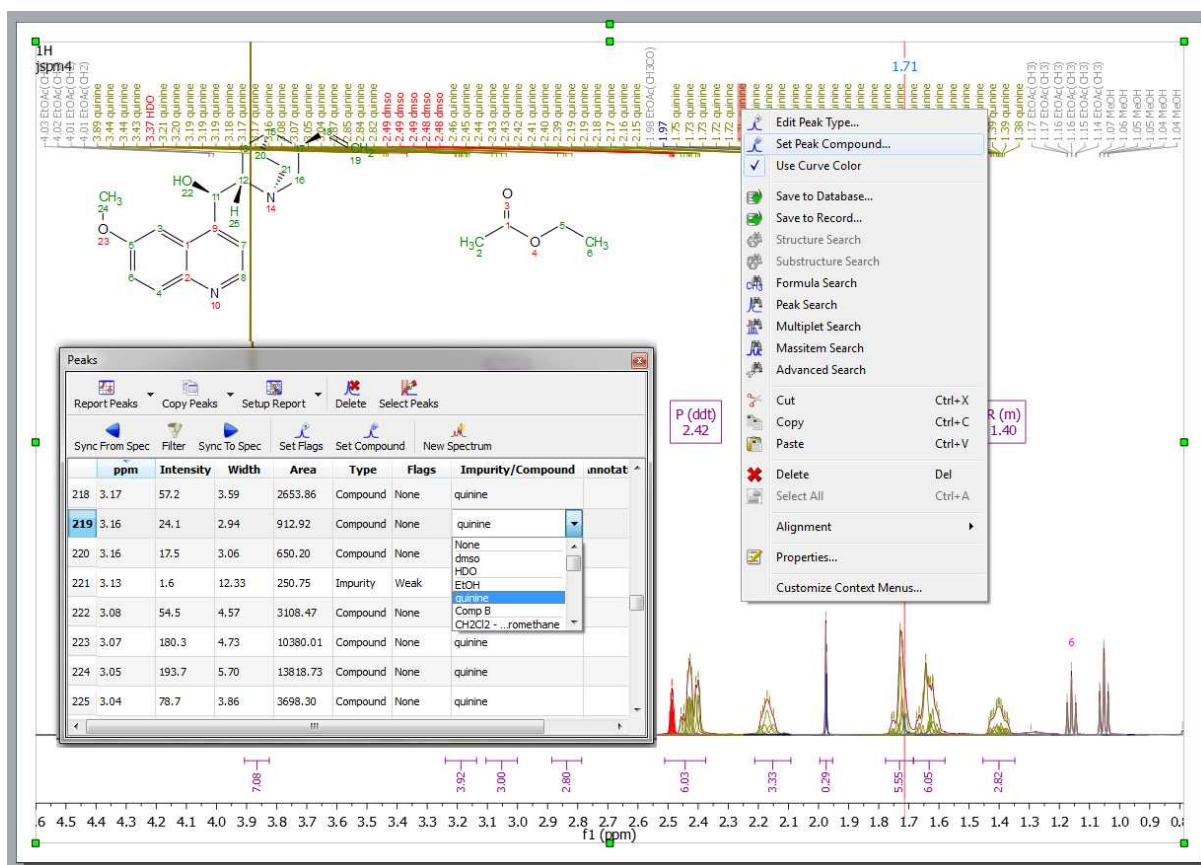

You could also use the molecular structure of your 1H-NMR spectrum (first page of the document below) and make the assignments on the 13C NMR spectrum (second page in the document below) or on any other dataset; if all the spectra are in the same document:

Step 2: Select a spectrum region for atom [12]. (Press Q to clear selection)

Atom	Chemical Shift	2D-COSY	2D-TOCSY	2D-HSQC	2D-
a	8.51, 9.43				
3 CH	113.07, 113.65				
a	6.43, 6.51				
4 CH	115.22, 115.92, 115.59				
a	6.37, 6.43				
5 CH	126.44, 126.89, 126.67				

Step 2: Select a spectrum region for atom [12]. (Press Q to clear selection)

Once you have finished with the assignment, you can visualize the assignment list by following the menu 'View/Tables/Assignments' where you will also be able to edit any entry by double clicking on it and overwriting the new value. Hovering the mouse over any cell of the table, will highlight the signals on the spectrum and the atom on the molecular structure.

Bear in mind that you are also able to carry out the peak assignment directly from this table by typing the applicable chemical shift in the edit box.

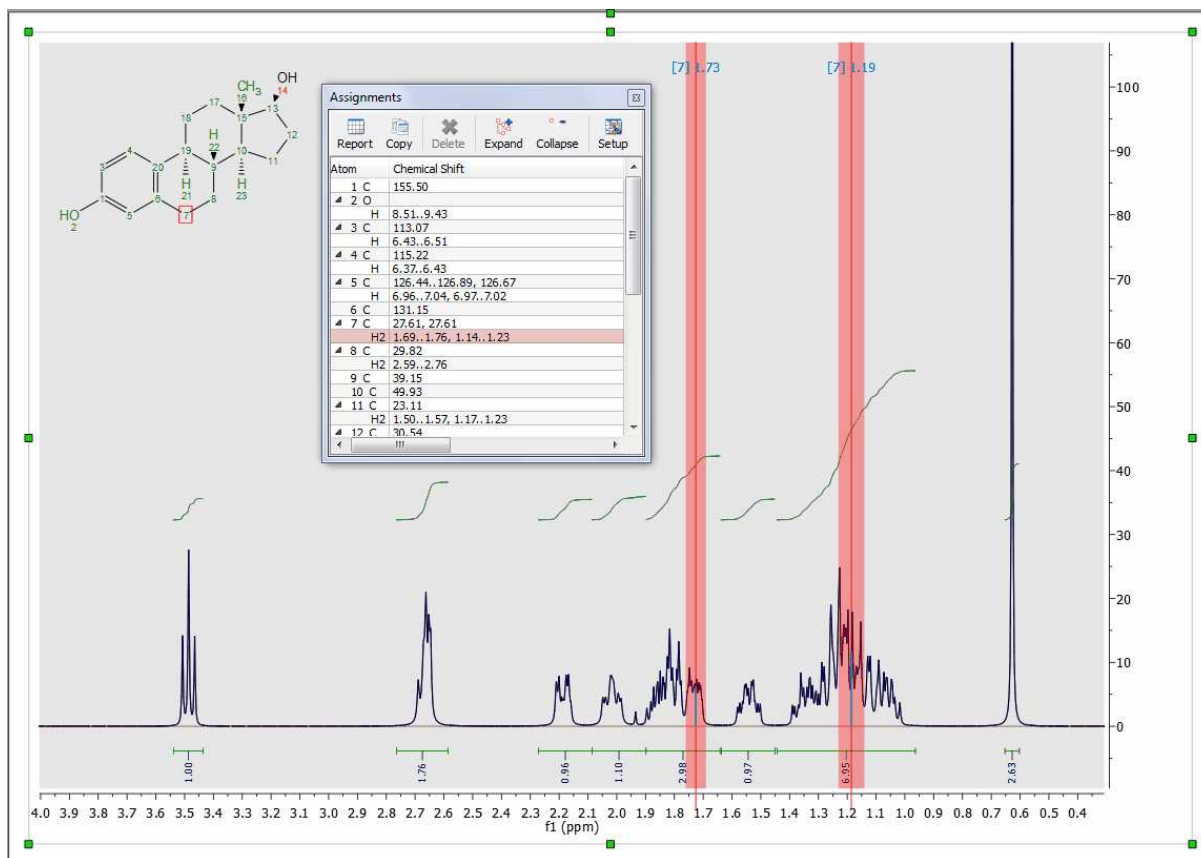

If you use the Assignment table to type directly the assignment of a CH₂ you would need add the prime marks if you want to assign only any of the two protons. If you do not type the prime marks, the assignment will be applied to both protons.

For example; typing this in a CH₂ row: **3.0, 3.5', 3.7''** means that 3.0 ppm is the chemical shift of both protons and in addition the H' has a signal at 3.5 ppm, whilst H'' appears also at 3.7 ppm. The assignments table will automatically refresh showing something like this (after having typed: **3.0, 3.5', 3.7''**):

Atom	Chemical Shift	Pr
21 C		
H'	3.00, 3.50	
H''	3.00, 3.70	
22 C		

It will be possible to change the label of a -CH₂ group, just by double clicking on the applicable 'atom cell'. You can also change the atom number by double clicking on the applicable atom cell:

Atom	Chemical Shift	Predicted Shift	COSY	T
H3	2.43			
20 C	2.58			
	2.39			
21 a	2.05			
d	1.87			
cis				
22 ax	3.04			
H				

From the assignment table, it will be possible to delete any assignment by clicking on the Delete button after having selected the applicable cell in the table. To delete 'All the assignments' from the table, just do 'Ctrl+A' to select all the assignments and click on the Delete button. The same effect will happen if you follow the menu Analysis/Assignments/Delete All Assignments or if you right click on the molecule to display the context menu:

It will be possible to add (or replace) a second chemical shift assignment to a single nucleus. This feature will be very useful if you need to assign rotamers or make ambiguous assignments.

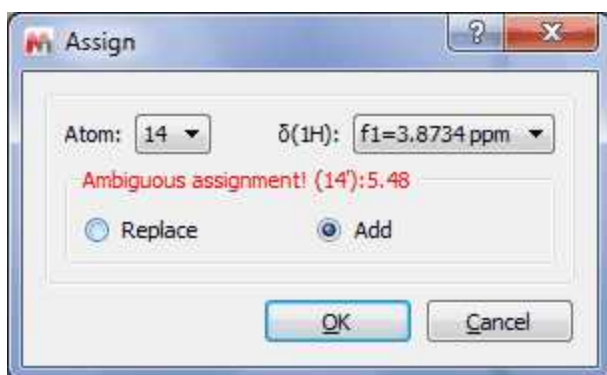

Assignments in 2D

Once you have assigned the ^1H and the ^{13}C spectra, if you open in the same document a 2D-NMR spectrum and you link the spectra (from the Assignments table), you will see the assignments graphically on the screen and hovering the mouse over the atom will highlight the applicable chemical shift. In the example below, you can see the correlation between the two hydrogens and the carbon of the position 12 in a HSQC:

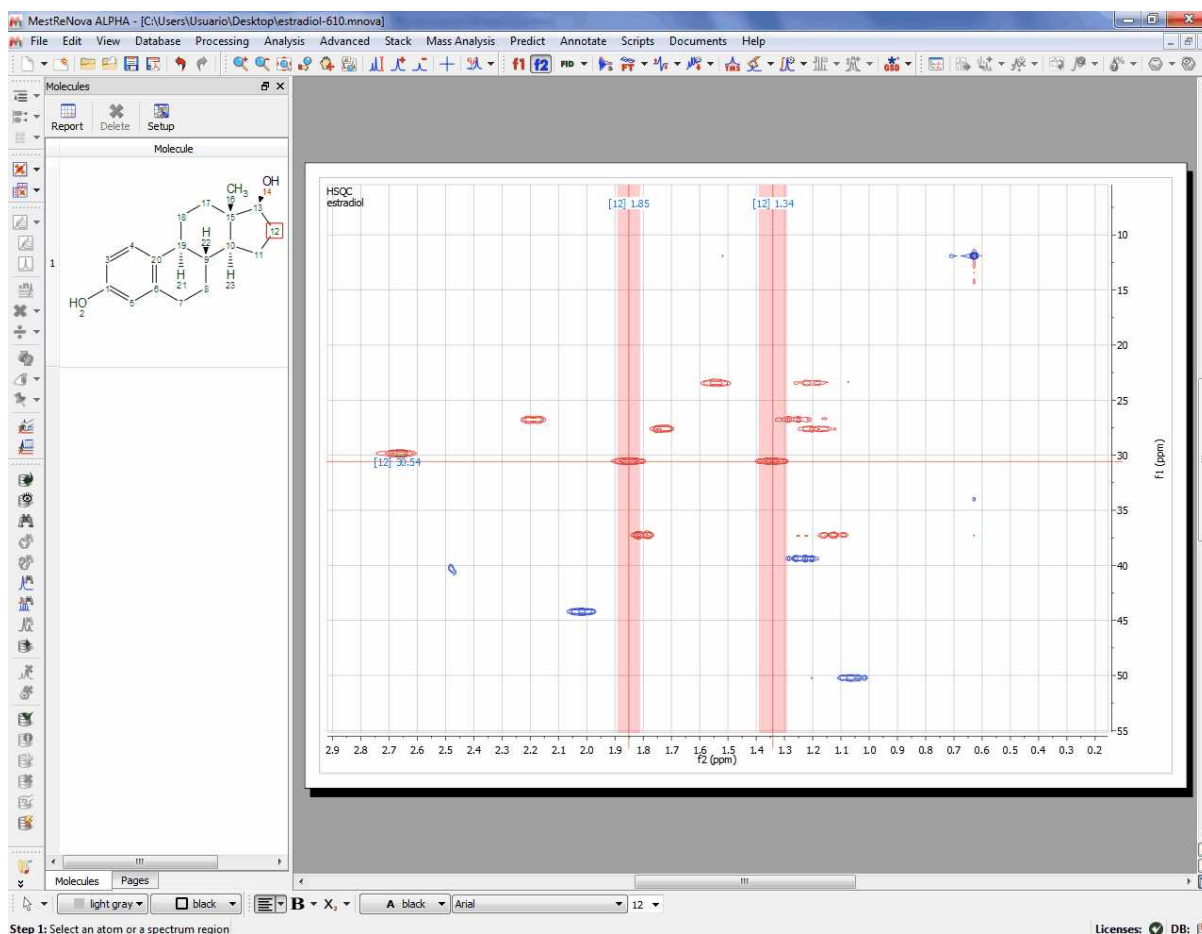

It is also possible to carry out assignments to 2D spectra by typing the applicable number of the atom in the 'Assignments Table' or **graphically** by selecting the atom in the molecule structure and the

corresponding signal in the 2D:

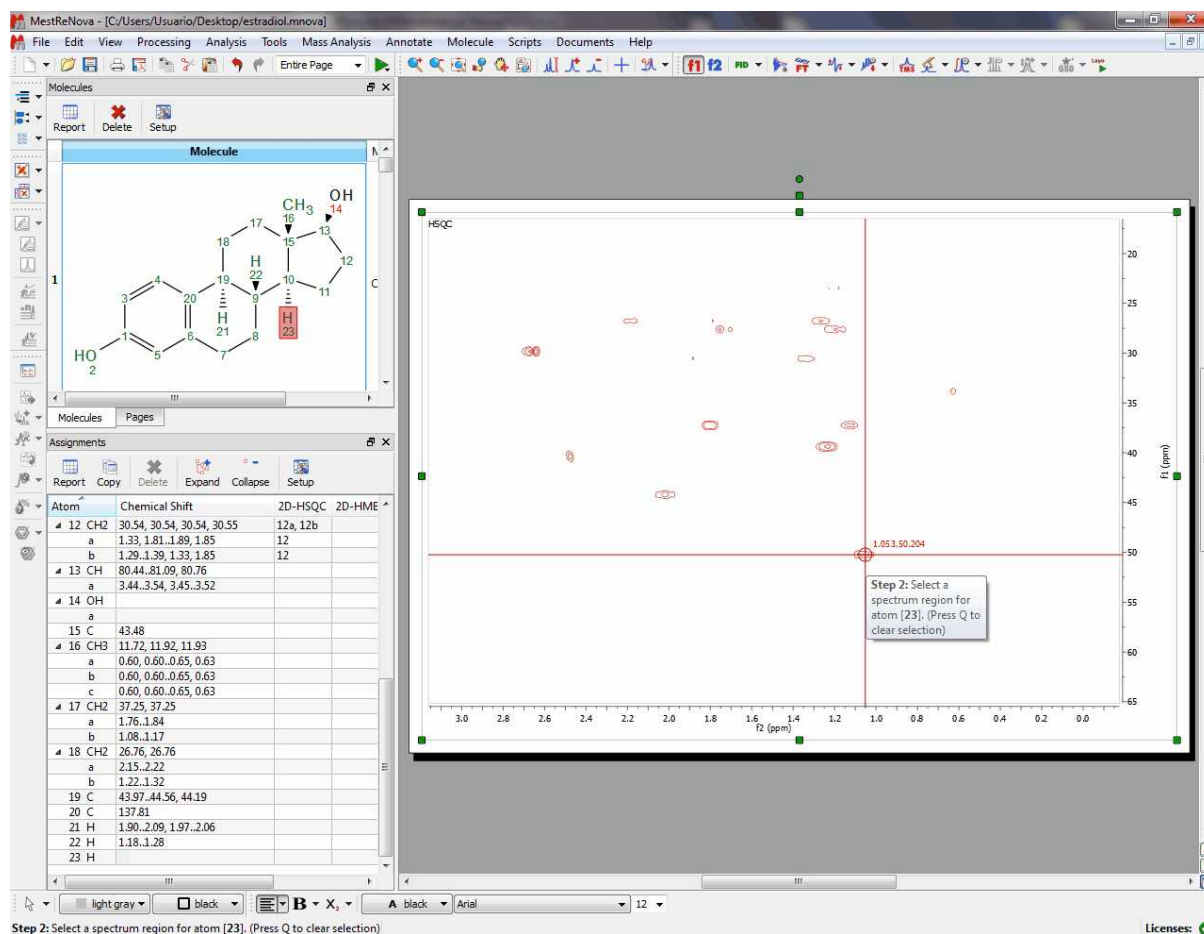

After having clicked on the 2D, a new window will be displayed to select the involved atoms (in that case, you will only need to select the atom 10 in f1):

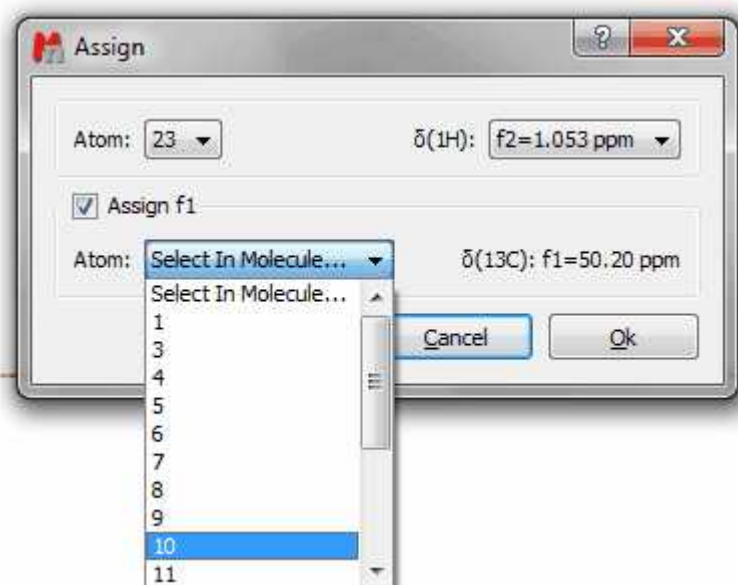

If you had already assigned the atoms in the 1D datasets, you will obtain a dialog box like this (which will allow you to keep the assignments from the 1D, replace or add new assignments):

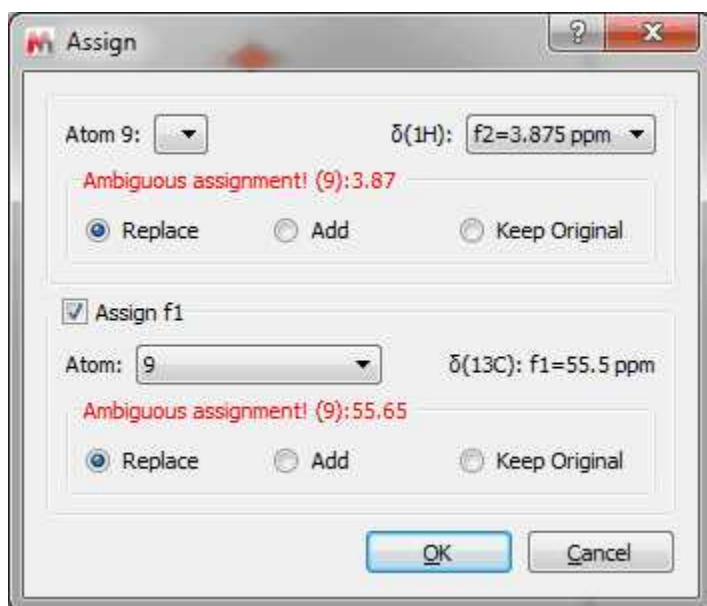

Finally click on OK and hover the mouse over the atom 23 to see the result (please notice how the assignment table has been automatically filled with the number '10' in the HSQC column, in order to show the correlation between the C-10 and the H-23)

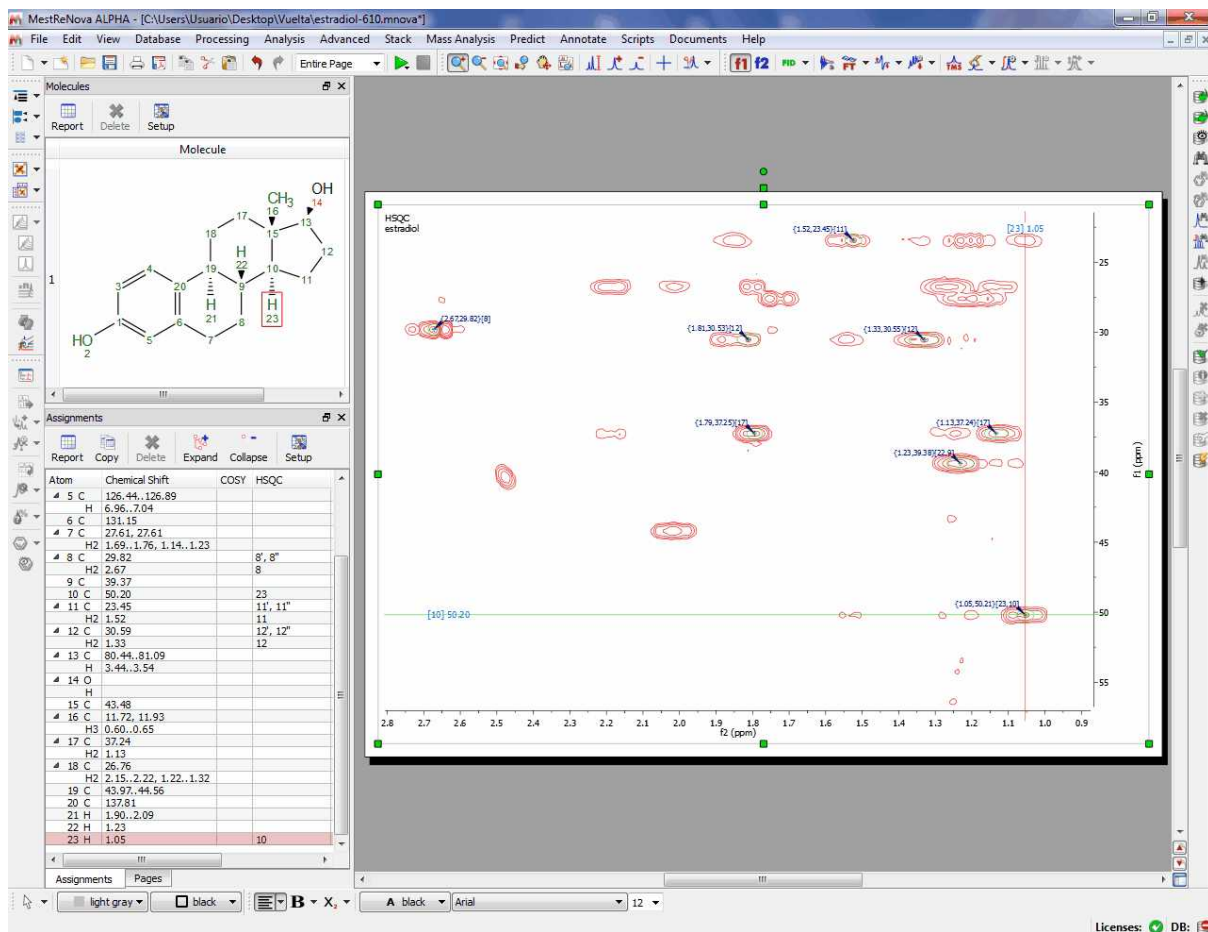

You can also copy several datasets in the same page (and after having resized them) to make the assignments. Here you can see a page which contains a 1H, 13C and HSQC datasets with an assignment in the molecular structure:

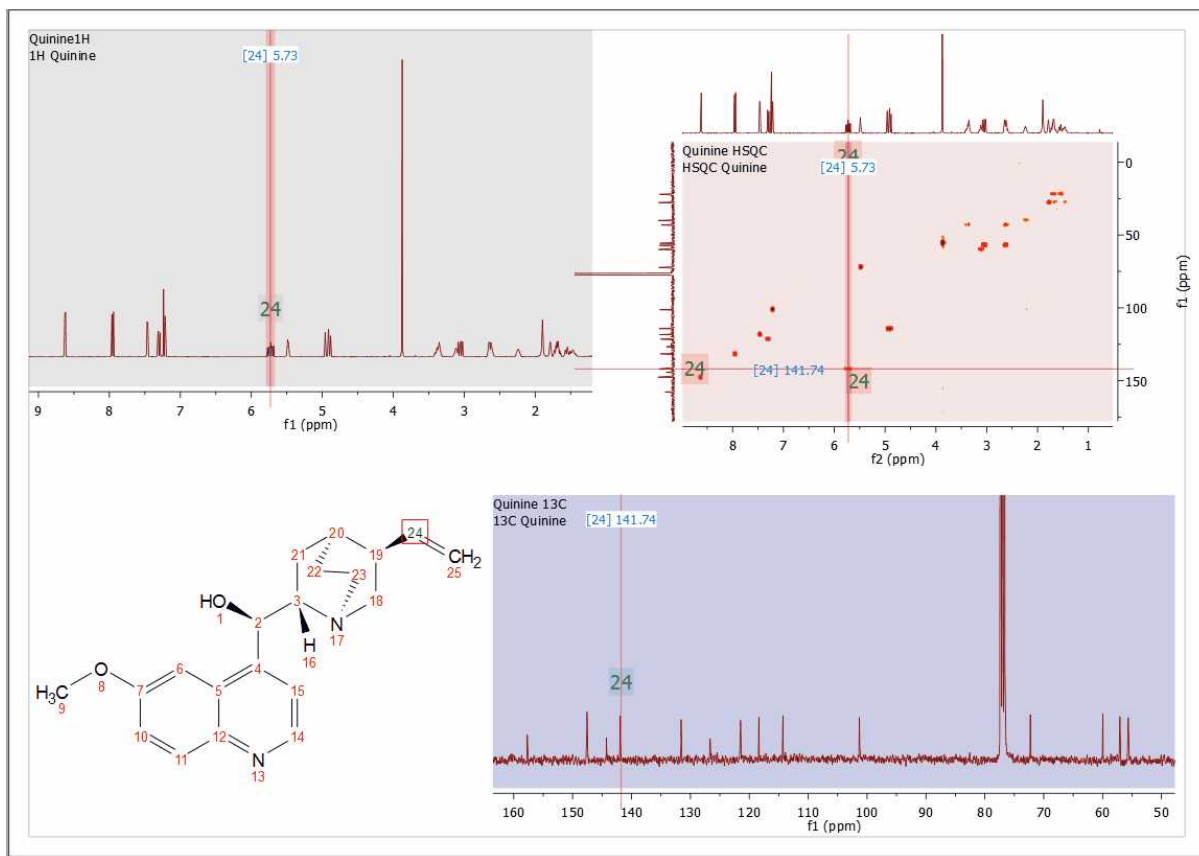

It is also possible to export your assignments in journal format by following the menu 'Scripts/Report/Assignments'. Then, a dialog will appear, from where you can select to the correlations H-H and C-H to be shown, to copy only to the clipboard or paste to the document and to order by chemical shift.

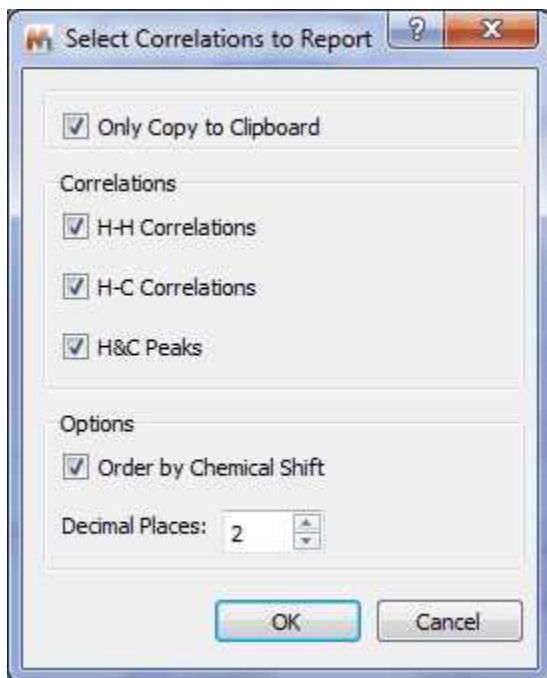

Finally, you will get the report of the assignments pasted on the spectral window:

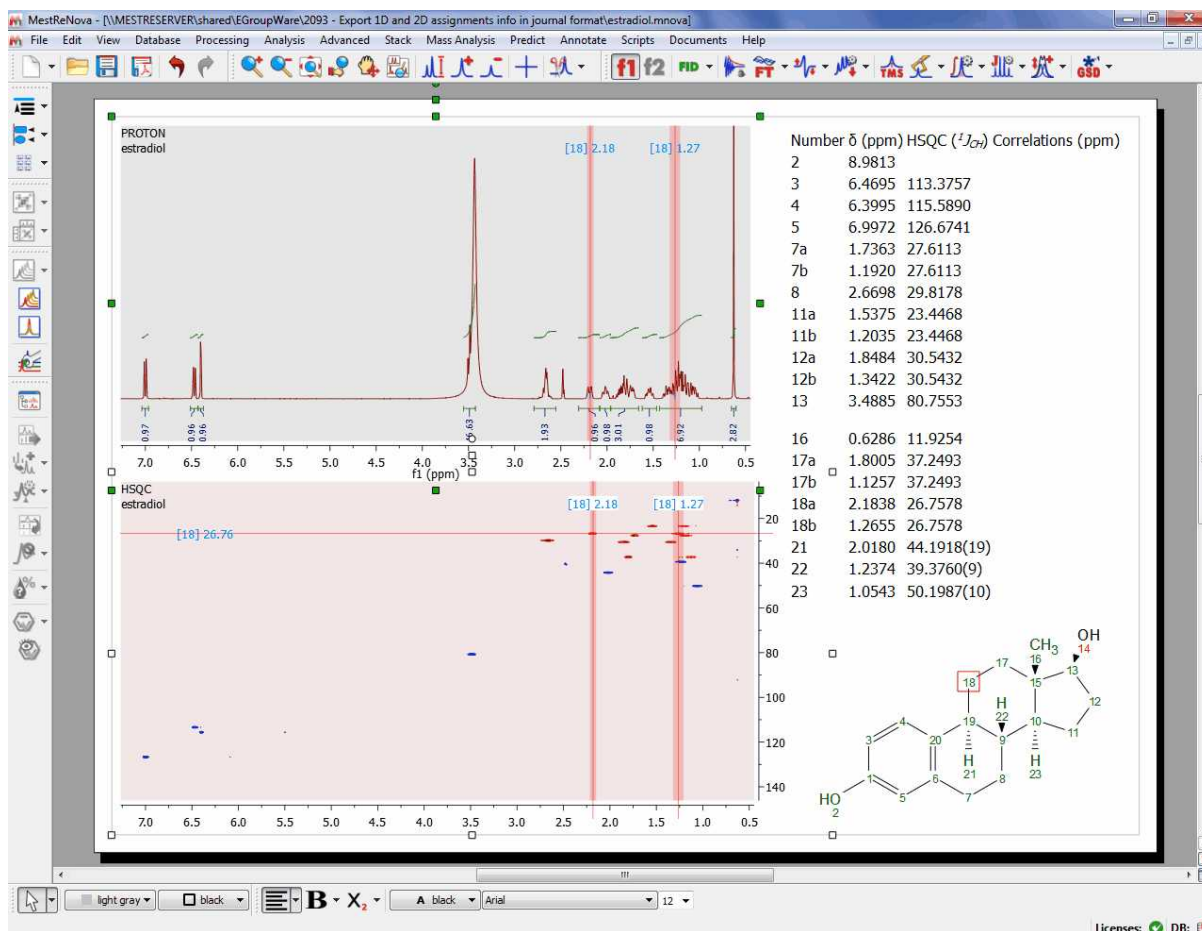

It will be also possible to export the assignments as an ASCII file, just by following the menu 'File/Save As/Script:Assignments'

See also this [post](#)

9.8.1 Transferring assignments through datasets

We recommend you to assign your atoms to your multiplet boxes in the 1H NMR spectrum in order to **transfer assignments through datasets**.

Let's see how it works:

1st: Open for example a 1H, 13C and HSQC datasets and the applicable molecular structure in the same document.

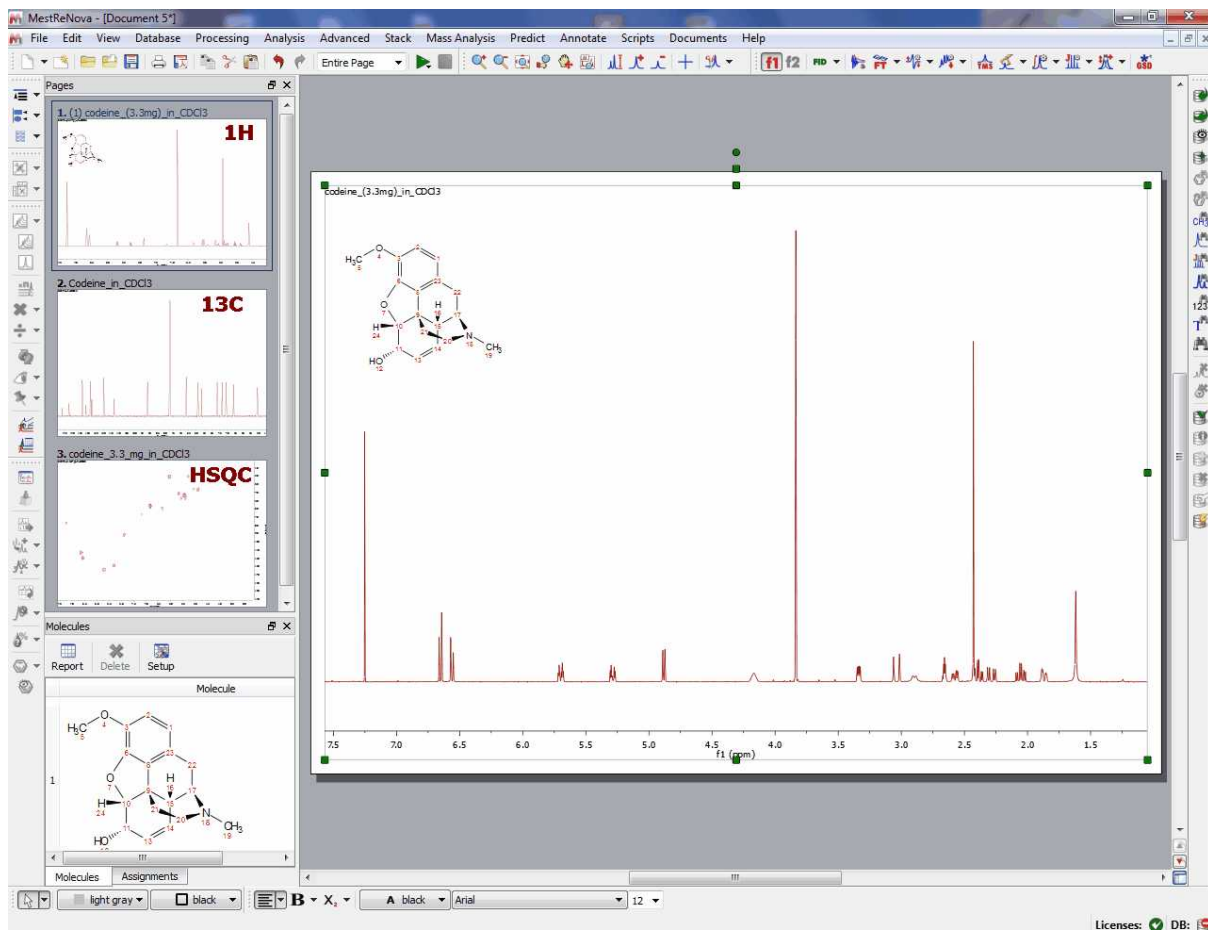

2nd: Apply a Peak Picking in all the datasets and a Multiplet Analysis in the ^1H -NMR spectrum:

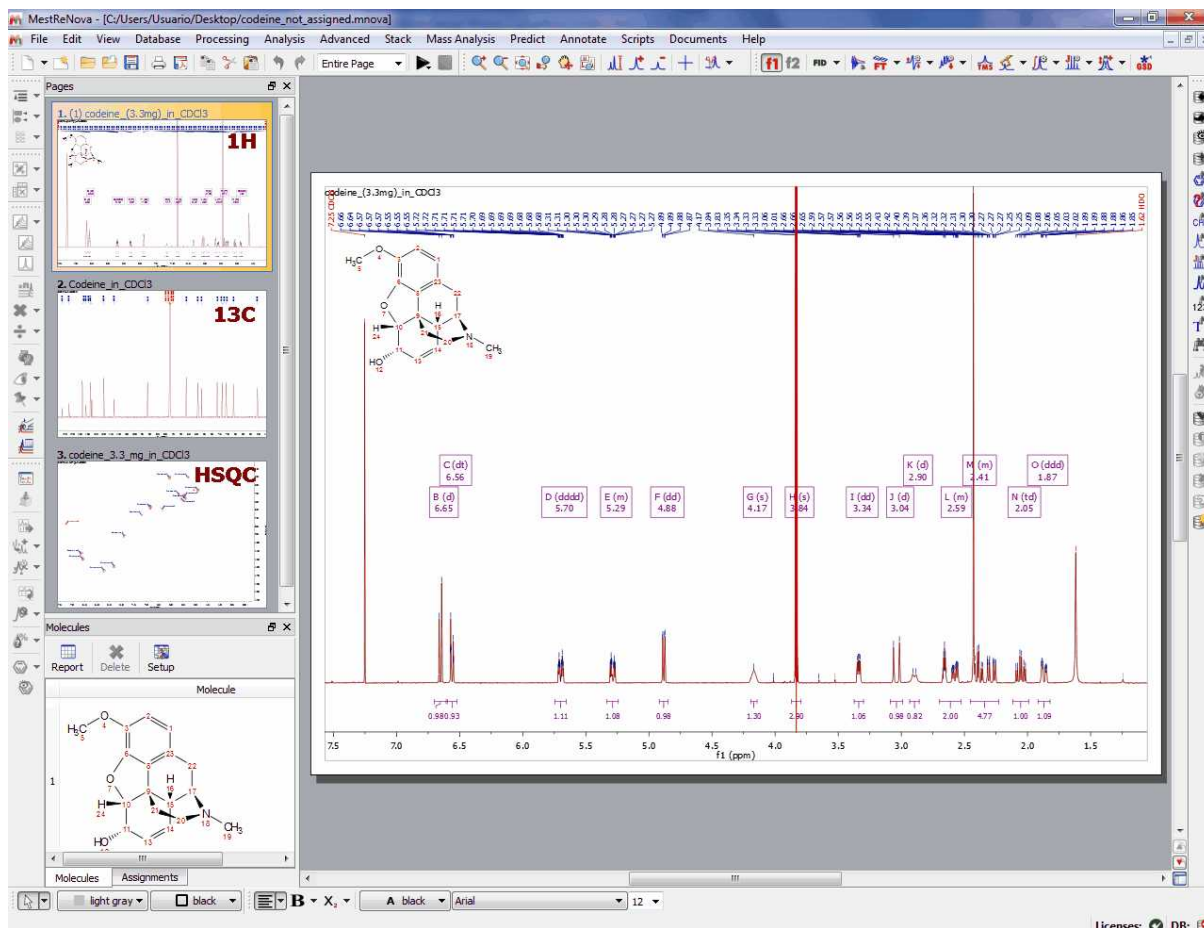

3rd: Make sure that you link all the spectra of the document from the Assignments table:

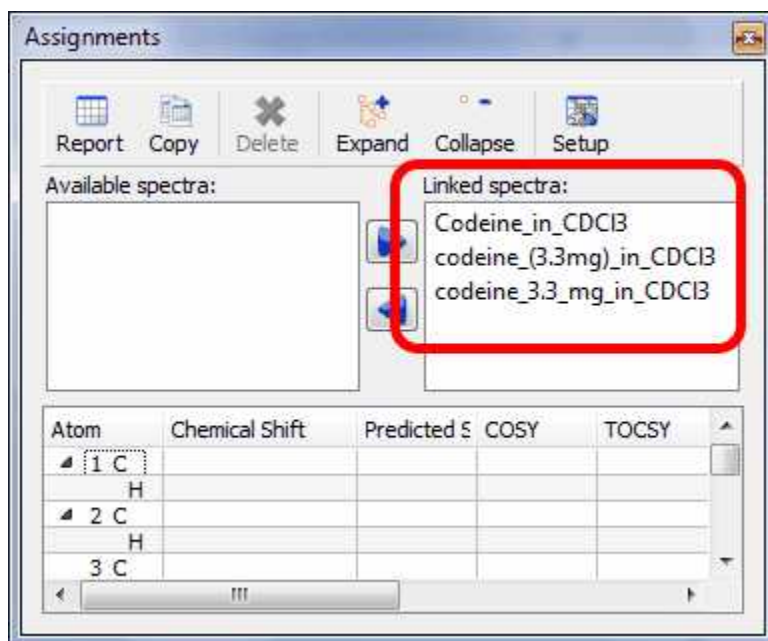

4th: Make an assignment to a multiplet box in the 1H-NMR spectrum. In that case we have assigned

the atom 2 to the multiplet box at 6.65 ppm:

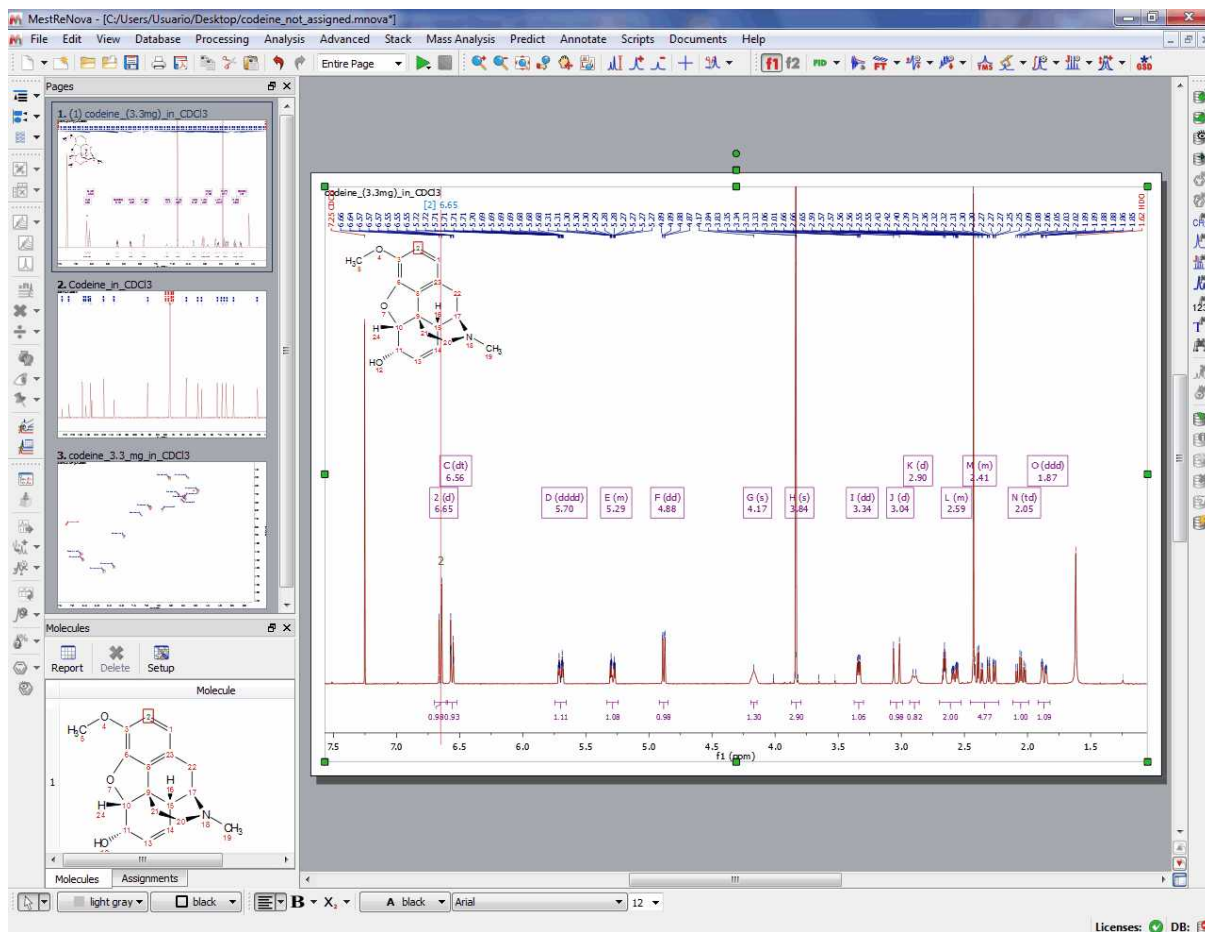

5th: And that's all! Jump to the 13C and automatically you will find the applicable assignment:

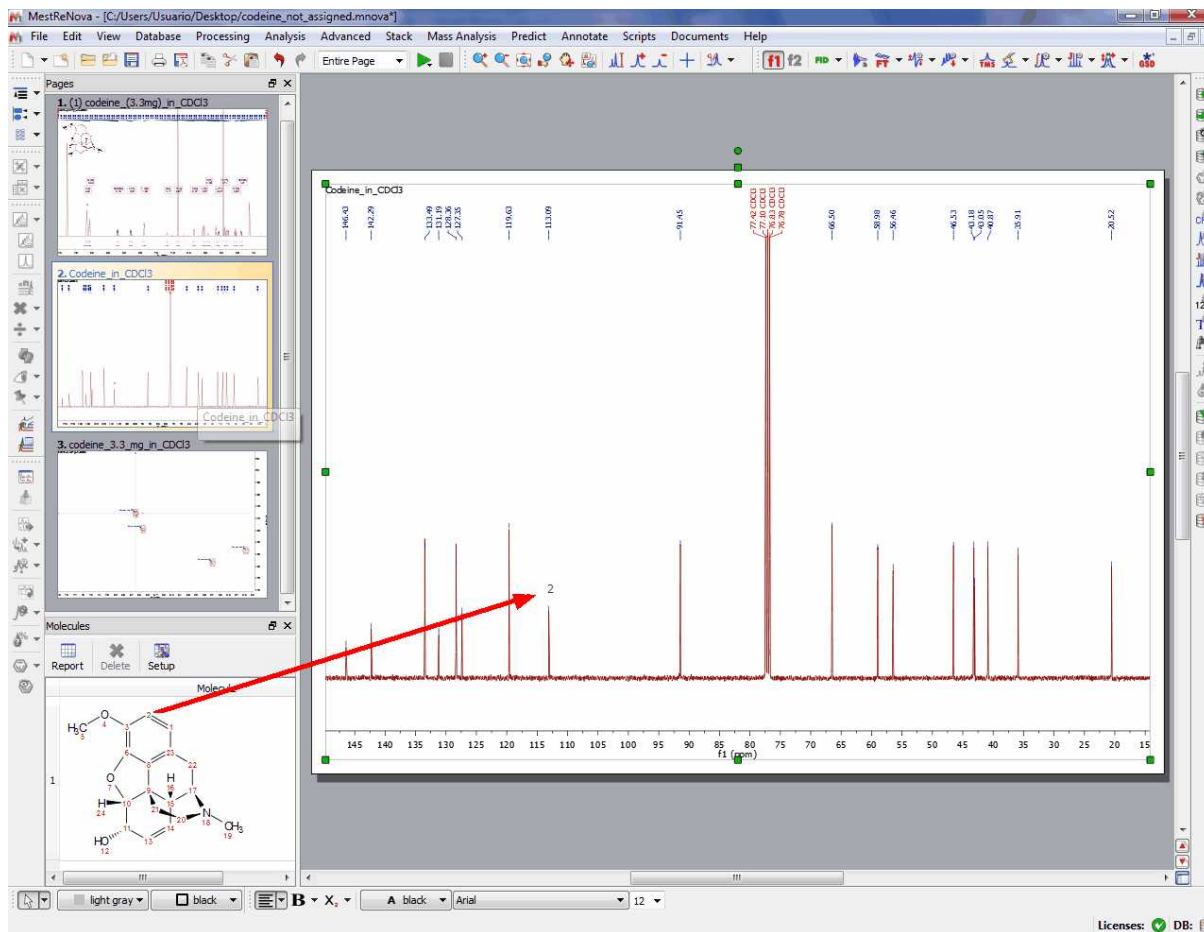

....and the same with the HSQC as you can see below:

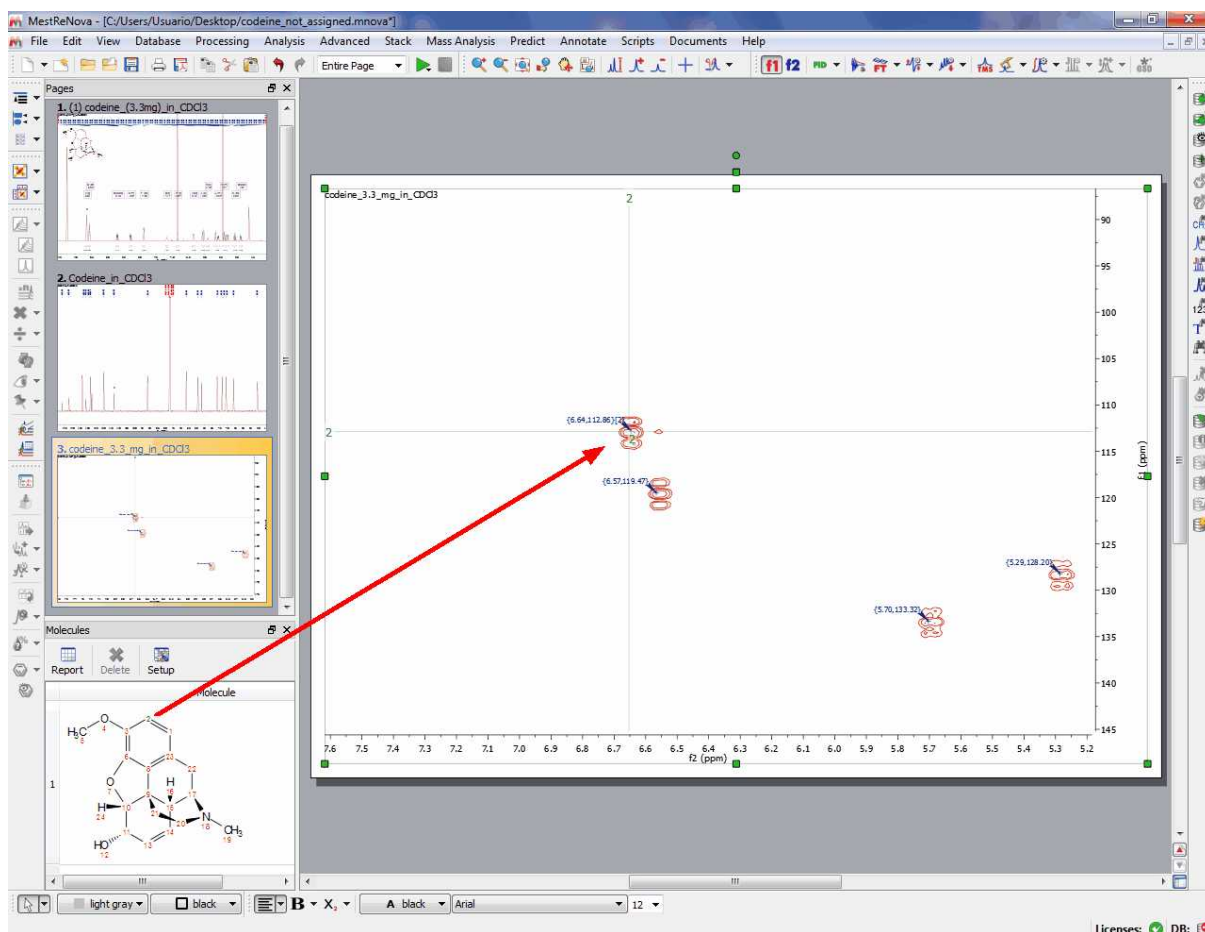

9.8.2 Assisted assignment by using the predictions

It will be possible to use Predict&Compare (or Predict&Verify) to make your assignments

Just open a 1D dataset with a molecular structure and follow the menu 'Analysis/Predict&Compare'. After the prediction is run, Mnova synthesizes the corresponding 1H-NMR spectrum using a rigorous full quantum mechanics method taking into account any second order effect present in the predicted spin(s) systems(s).

For example, in the figure below, you can see the results of running a prediction and comparing the resulting 1H spectrum with its experimental counterpart and the applicable assignments for the predicted spectrum:

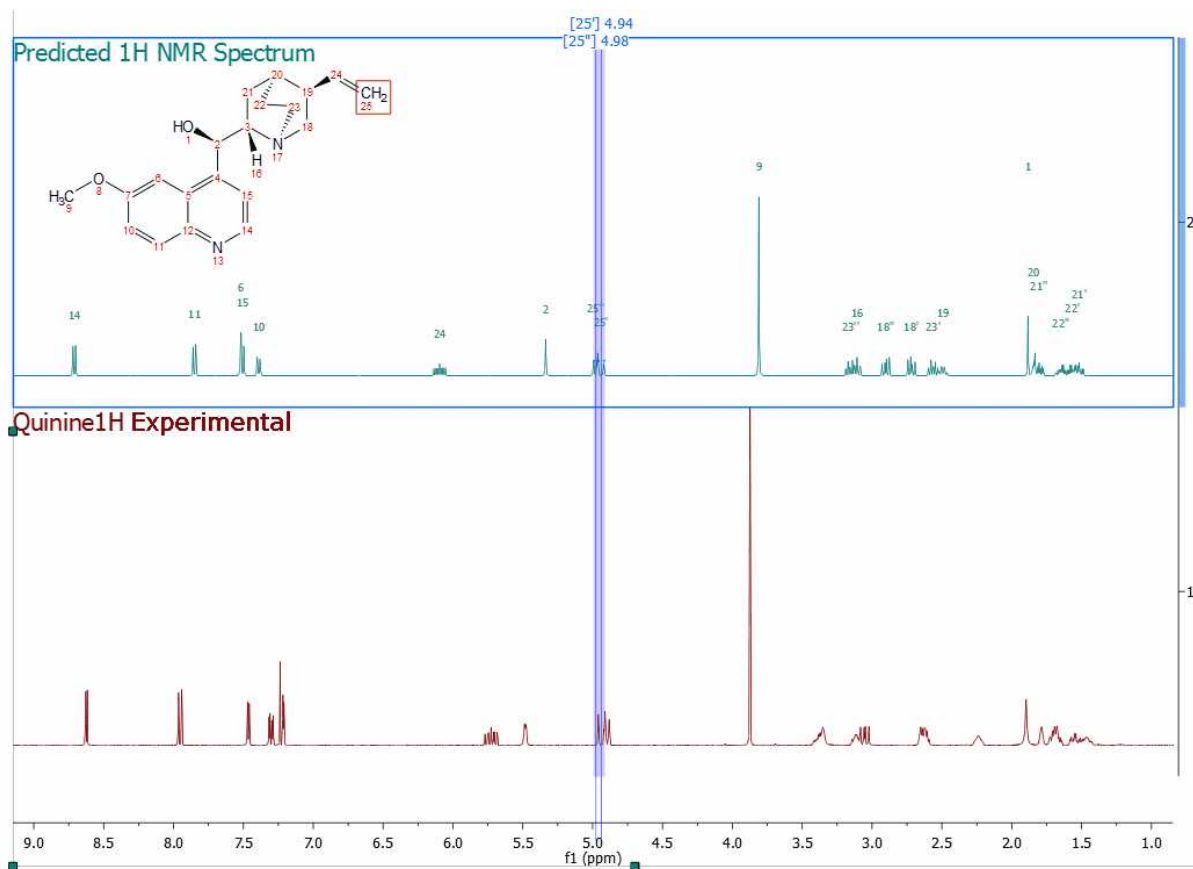

Next, you will only need to press the 'A' key to activate the assignment mode and select the atom and the applicable region of the experimental spectrum to be assigned (following the assignments of the predicted spectrum):

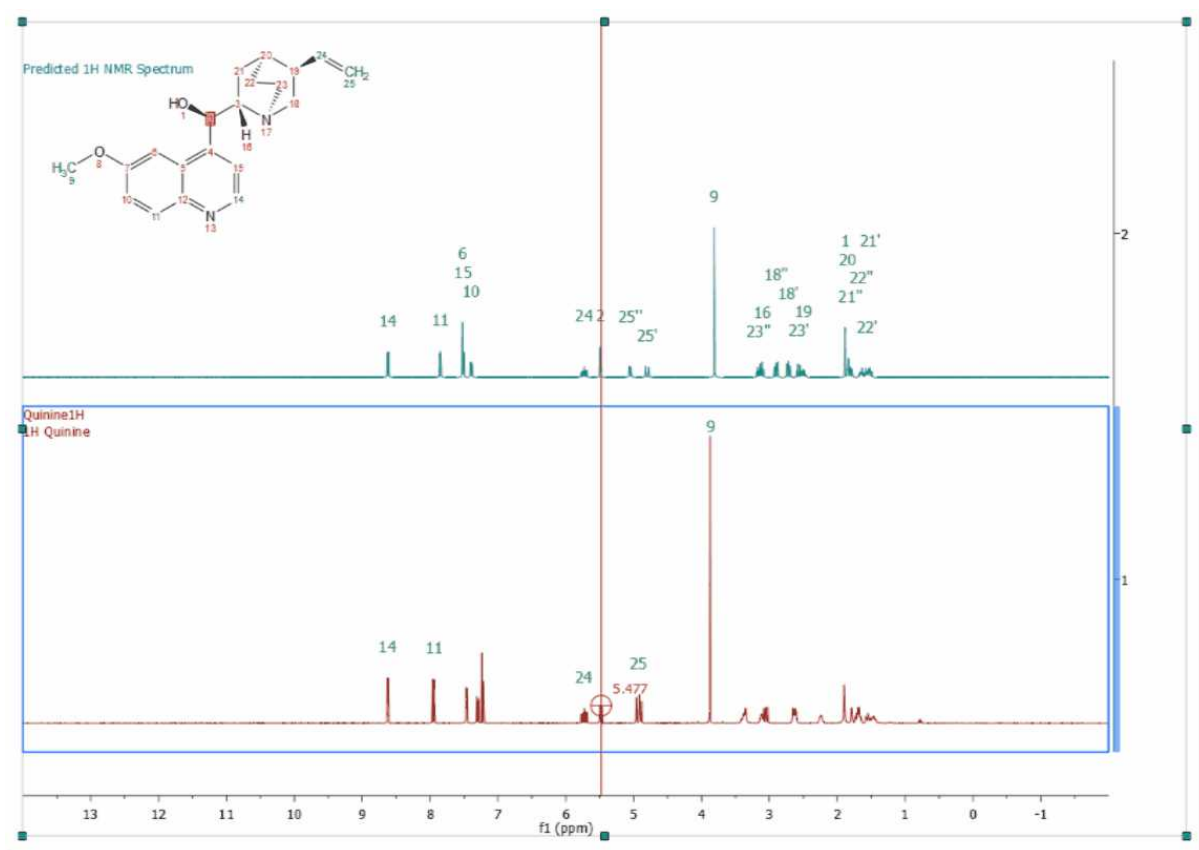

9.8.3 Copy assignments from one molecule to another

It will be possible to **copy assignments** from one molecule to another (the numbering of the common atoms must be the same). To do it, just select the first molecular structure with the assignments and do 'Ctrl+C'. Finally select the second molecular structure and follow the menu 'Edit/Paste Properties/NMR assignments':

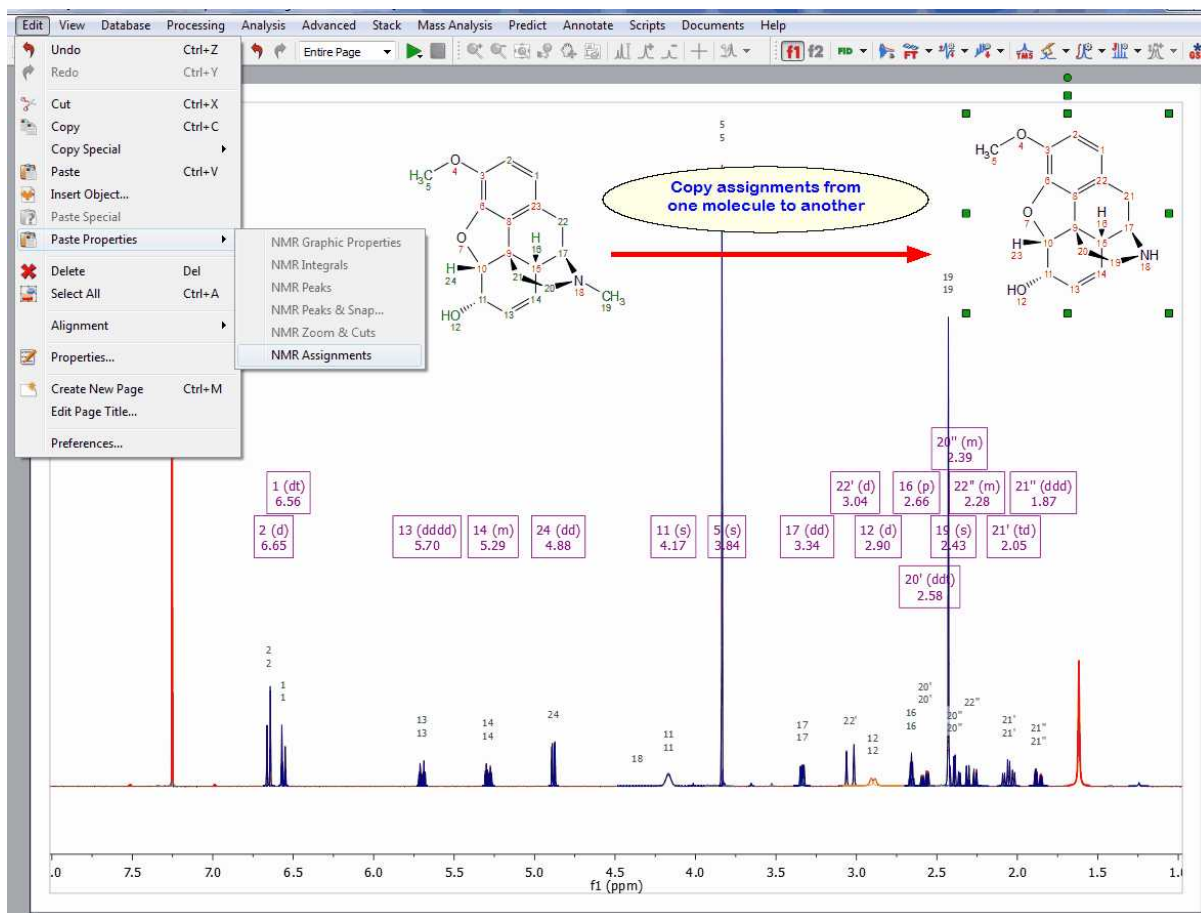

9.8.4 Assignments Properties

It is possible to change the properties of the Assignments labels just by double clicking on the spectral window and selecting 'Assignments' in the left tabbed menu. Once there you will be able to select the font, background, frame and form of the labels:

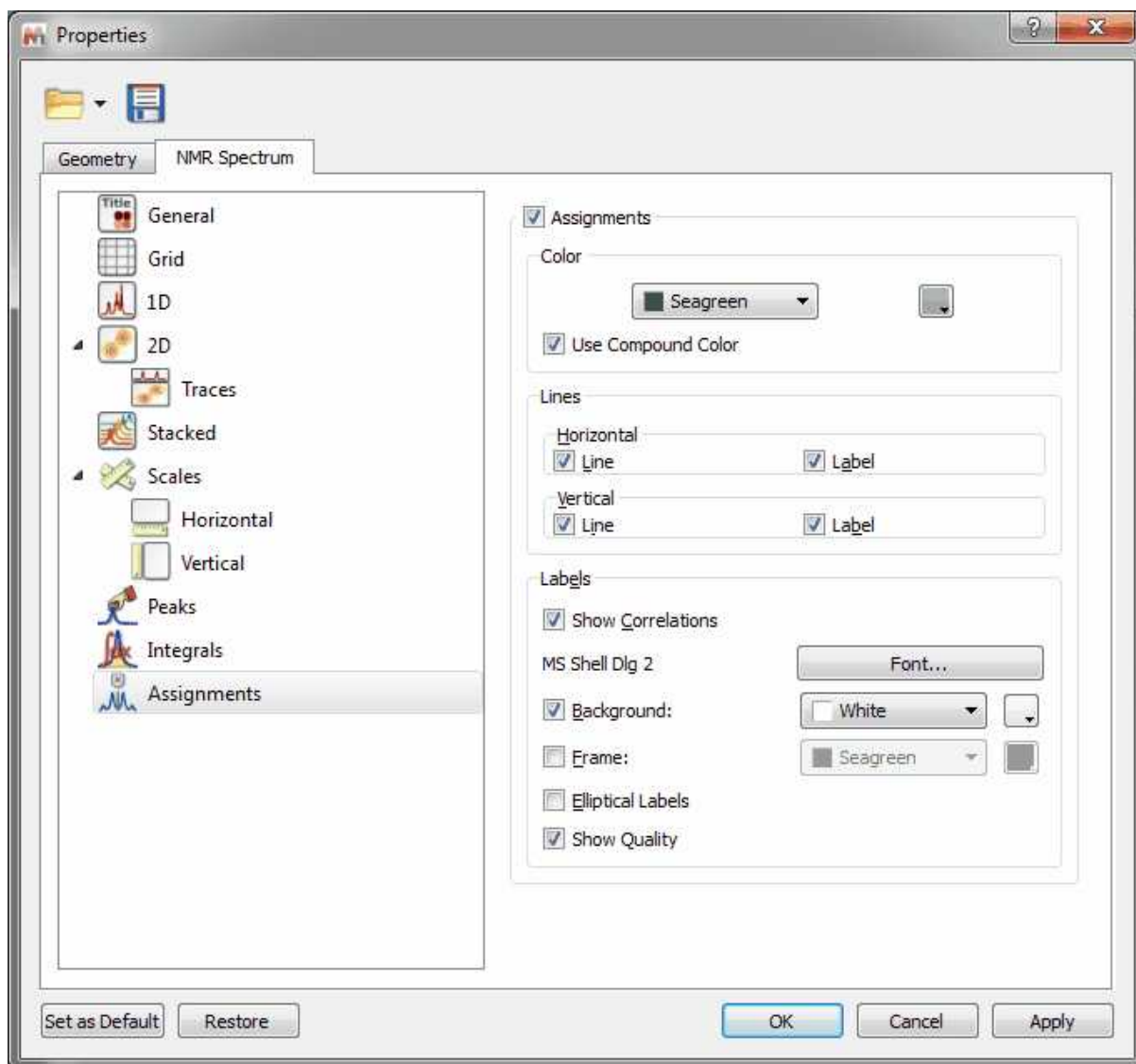

If you have several compounds in your document, you can use the same color compound for the assignments labels (green and blue in the example below) by checking the applicable box:

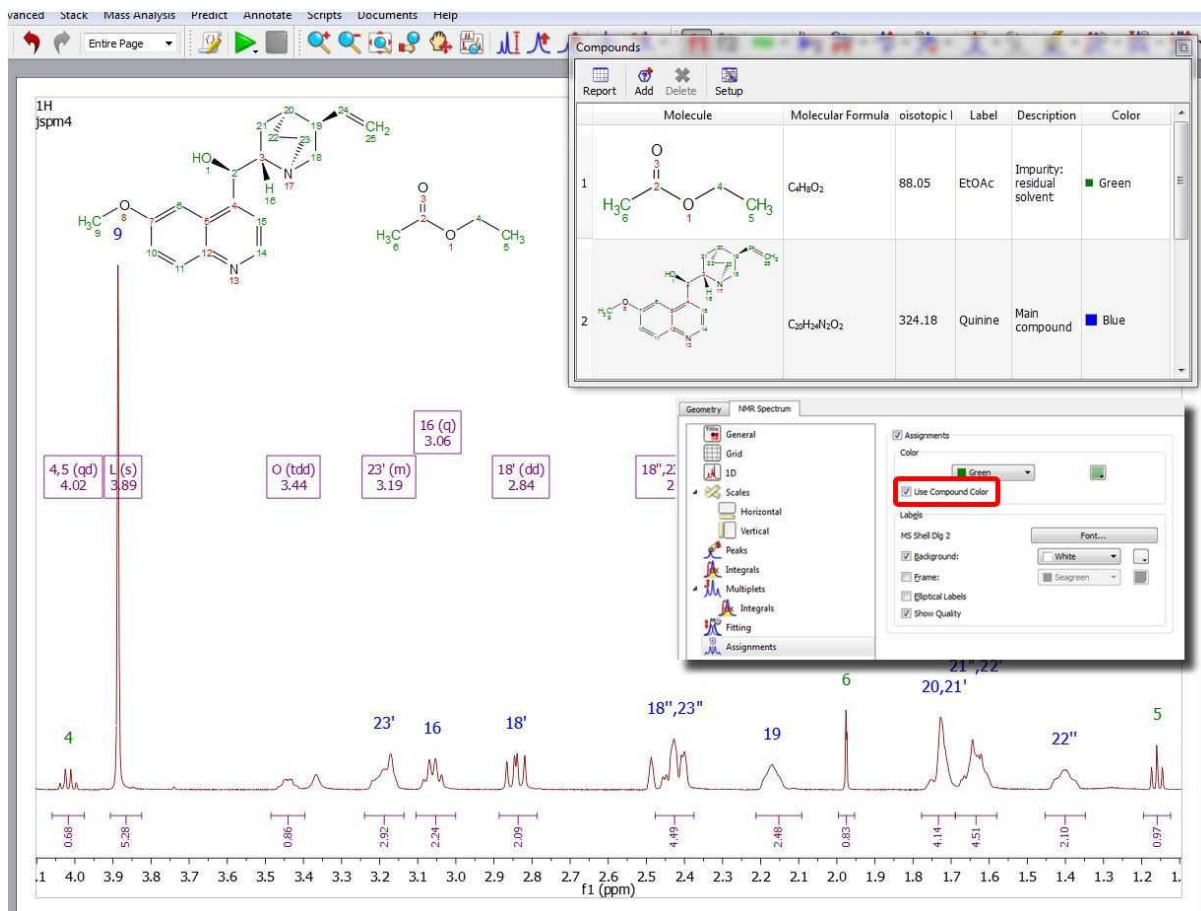

It will be possible to hide the assignments in a spectrum by unchecking the 'Assignments' box (or lines boxes for 2D) in the Assignments Properties. You can also do the same by right clicking on the molecule and selecting the applicable option:



The same effect will be obtained by right clicking on the 'Linked Spectrum' from the Assignments table and selecting 'Disable Link':

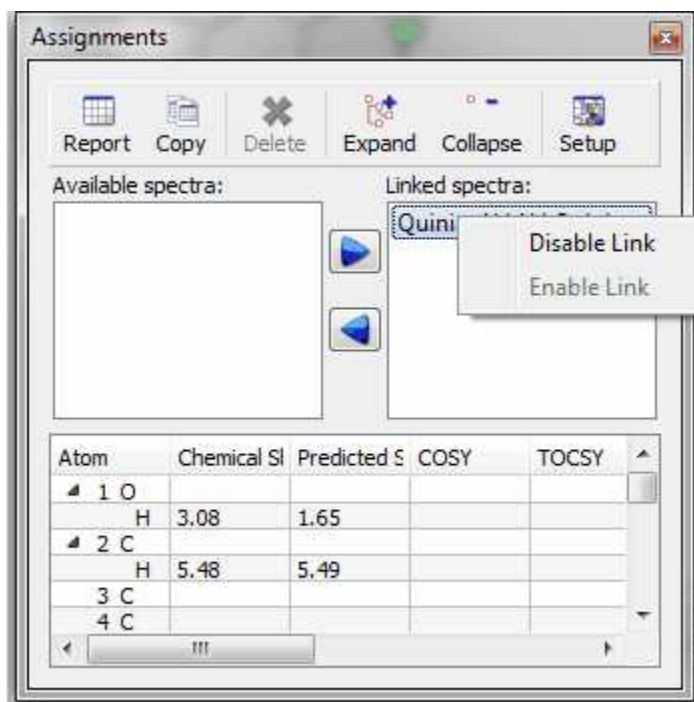

9.9 NMR Prediction

NMR Prediction: The handling of molecular structures within **Mnova** also allows the user to carry out **spectral predictions**. Although the process described here could be applied to predictions by means of any commercially available or in-house prediction package, currently **Mnova** will carry out predictions by using the prediction application **NMRPredict**, by **Modgraph Consultants Ltd**.



A few notes on NMR Prediction

- ✓ Our intention is for **Mnova** to support predictions with a range of prediction packages as wide as possible.
- ✓ Currently, predictions can be carried out by using **NMRPredict**, the prediction software by Modgraph Consultants Ltd. An evaluation version of NMRPredict can be downloaded from <http://www.modgraph.co.uk>
- ✓ **NMRPredict** comes into two different flavours:
 - [NMRPredict Desktop](#)
 - [NMRPredict server-based](#)
- ✓ Customers who have their own in-house prediction package are welcome to contact us to discuss a similar, seamless integration of their own prediction package. Please write to us at support@mestrelab.com.
- ✓ Please note that NMRPredict is a different software package to Mnova and therefore, in order to carry out predictions via this package, a license of NMRPredict must be held separately, once the NMRPredict evaluation has expired.

Mnova incorporates a fast simulation mode of ^1H , ^{13}C and X-nuclei (^{31}P , ^{19}F , ^{15}N , ^{17}O , ^{29}Si) NMR spectra, called **NMRPredict Desktop**.



The reference used for the prediction are listed below:

^1H , ^{13}C and ^{29}Si (0.00 ppm, TMS); ^{17}O (0.00 ppm, Water); ^{15}N (0.00 ppm, CH_3NO_2); ^{19}F (0.00 ppm CFCl_3); ^{31}P (0.00 ppm, H_3PO_4).

This application does not need to connect itself to a server for the spectra prediction. Besides, it makes use of the fastest prediction algorithms (**Neural Network**, **Charge**, **Increments** and **Best**) implemented into **NMRPredict**.

Watch a miniclip on this functionality [here](#)

9.9.1 Modgraph NMR Predict Desktop

Mnova integrates a fast simulation module of ^1H and ^{13}C -NMR spectra, called **Modgraph NMRPredict Desktop**.

See also ['How to predict a spectrum with NMRPredict Desktop?](#)

NMRPredict Desktop is faster than **NMRPredict server-based**, because it does not need to log in to a server to predict a spectrum. Besides, it makes use of the fastest prediction algorithms (**Neural Network, Charge, Increments** and **Best**) implemented into **NMRPredict**. Other very significant advantages are that the software can be used without an internet connection, there are no access issues with firewalls, and no risk to confidential data being sent over the internet.

NMRPredict Desktop uses a Neural Network system for the prediction of ^{13}C -NMR spectra, and the NMR tables (**increments** methodology) of Professor Ernö Pretsch (ETH, Zürich) for a fast simulation mode of ^1H and **X-nuclei**: ^{31}P , ^{19}F , ^{15}N , ^{17}O , ^{29}Si NMR spectra, as well as the **CHARGE** program which offers ^1H -NMR prediction based upon partial atomic charges and steric interactions.

NMR Predict Desktop also includes the calculation of heteronuclear (HF, HP, CF and CP) couplings.

CHARGE offers the **first** quantitative prediction of the proton chemical shifts of a variety of organic compounds. It works by first generating 3D conformers from a 2D structure through a choice of *force fields* and then predicting proton spectra for all the conformers. The program works by looking at functional groups which have been parametrised by Professor Abraham.

To read more about the scientific theory behind CHARGE, please visit the following link:

http://www.modgraph.co.uk/product_nmr_proton.htm

The **CHARGE** and the **Increment** algorithms included in **NMRPredict Desktop** are the same as used in the Server-based version to predict ^1H -NMR spectra, whereas for the prediction of ^{13}C -NMR spectra; **NMRPredict Desktop** uses a **Neural Network** system, but not the HOSE database methodology implemented additionally in the server-based application.

The **Best** algorithm is the combined approach between the Increments and the Conformers algorithm that is capable of producing significantly improved proton NMR predictions for the data set upon which it has been tested down to below the 0.2 ppm target error.

You will find further information about this feature in:

http://www.modgraph.co.uk/best_proton_press_release.htm

Please bear in mind that we are not giving any guarantees that the "Best" will always give prediction accuracy as low as 0.18 ppm. Statistically this is what we got against the 1.1 million shift values in the 90,000 data we used. This may or may not be the case with user data.

The **Neural Network algorithm** is much more general and error tolerant than the HOSE code approach (based on a reference spectra database) and is much more accurate at predicting shifts not found in the database.

The Neural Network prediction method in **NMRPredict Desktop** was developed during the mid 1990s in the group of Professor Robien at the University of Vienna. It was developed by V Purtuc and gave a very broad application range to cover general organic chemistry.

The basic design principles as defined in 1995 were:

- to be general enough and be able to handle problems from basic organic chemistry to complex natural products.
- to be able to handle "unusual" organic chemistry like organometallics.
- to be solvent specific during prediction.

- to be able to use stereochemical information not restricted by ring size, in the same way as could be done within the HOSE code technology.
- to make sure that only **interpolation** and not **extrapolation** occurred when making predictions.

The Neural Network implemented into **NMRPredict Desktop** has been thoroughly tested and proved to be both reliable and accurate. The 4,000,000 assigned chemical shift values of the available 345,000 reference spectra can be predicted with an average deviation between experimental versus calculated of below 2.00 ppm. This includes compounds which are not well handled by traditional prediction programs, such as ferrocenes and chromium complexes.



ATTENTION

Bear in mind that, in terms of stereochemistry, drawing a structure as a chair or as a boat means nothing to the .mol file and the computer. In those cases the user must draw all the corresponding bonds to show the stereochemistry of the molecule, i.e., you must explicitly draw up and down bonds using wedges.

9.9.1.1 Running predictions

Carrying out of predictions in Mnova with **NMRPredict Desktop** is very easy and intuitive. Just load a molecule into Mnova and right click on it to select the desired prediction (or follow the 'Predict' menu):

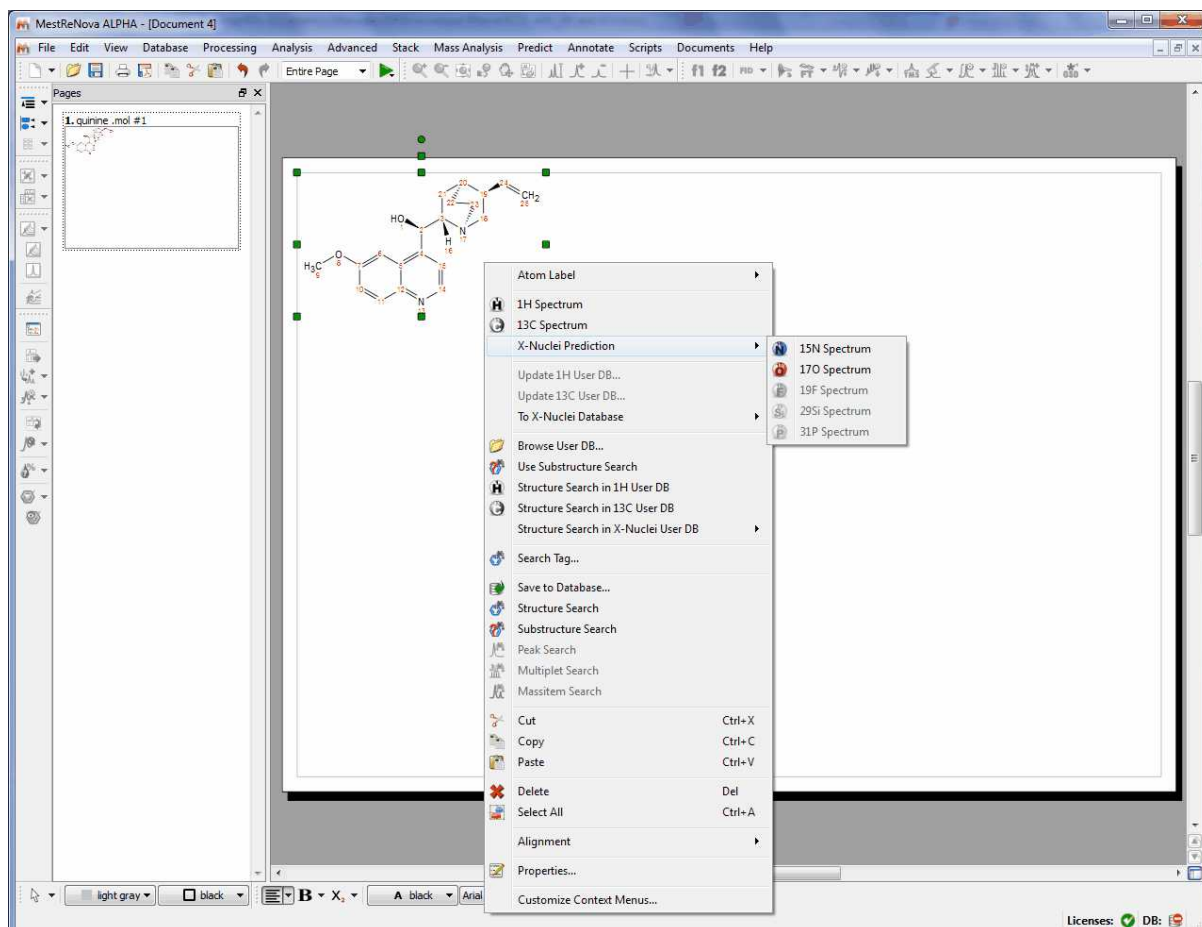

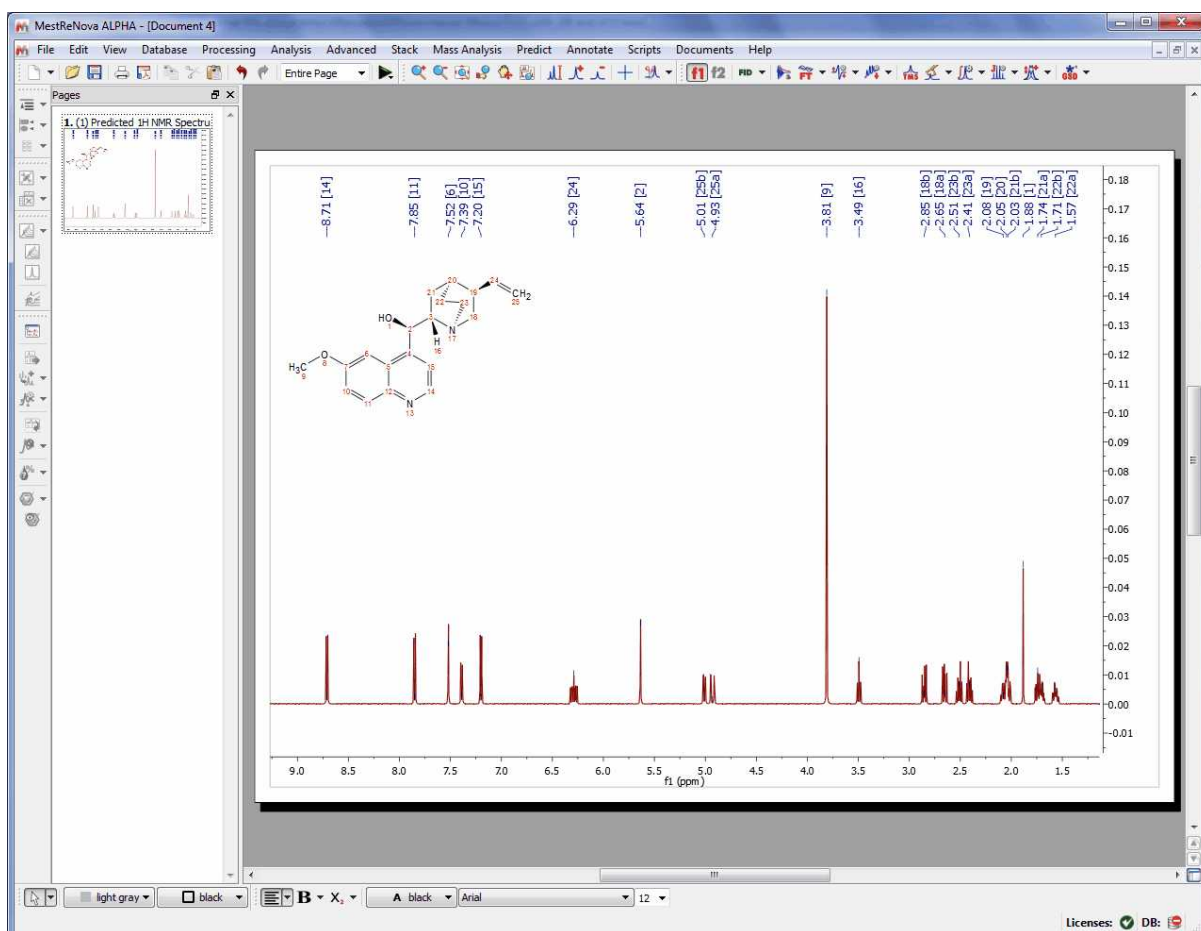

After that, you will obtain the desired predicted spectrum using a rigorous full quantum mechanics method taking into account any second order effect present in the predicted spin(s) system(s):

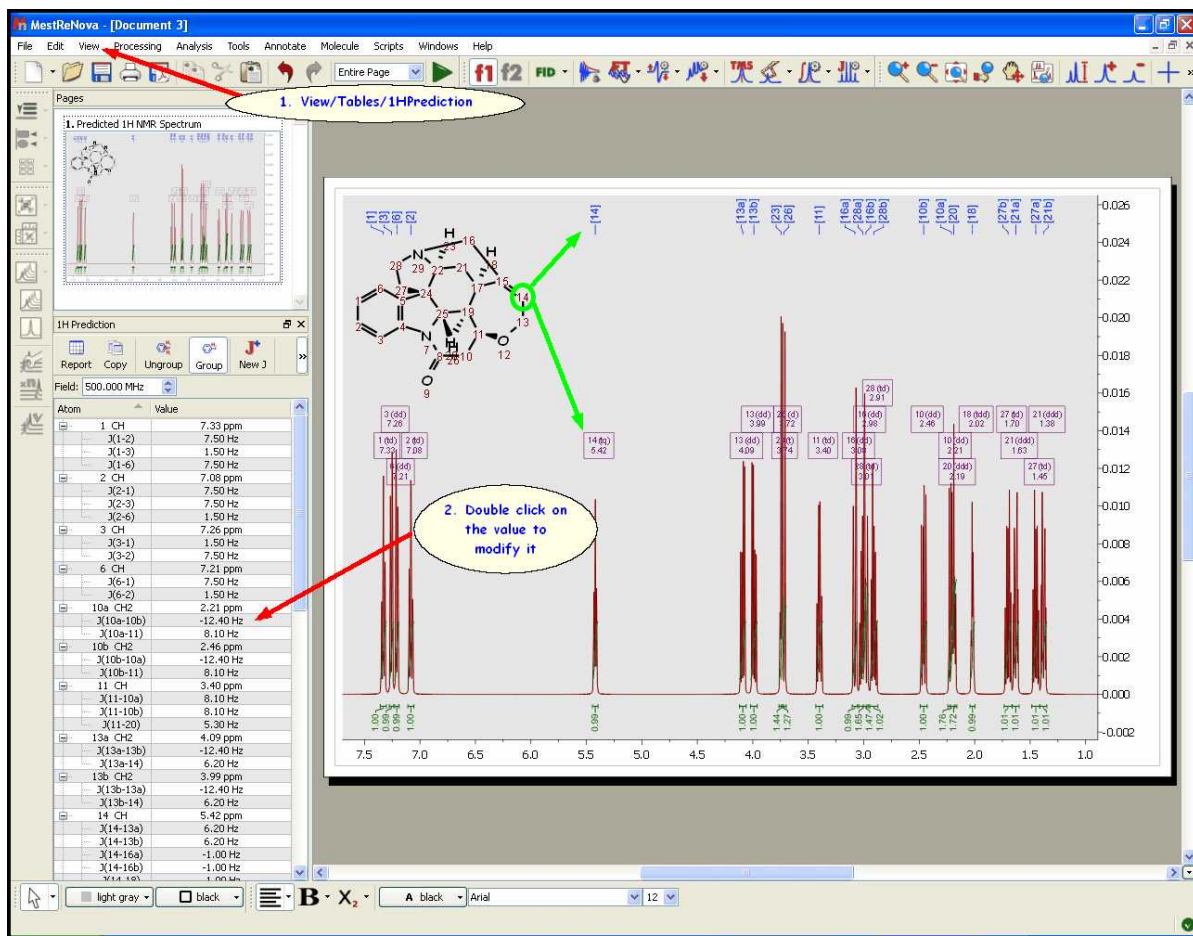

This predicted spectrum can be analyzed as a real one (e.g. it can be integrated, etc). The user can also visualize and edit the chemical shift and coupling constants values from the tables of the predicted spectrum by following the menu 'View/Table'. Please bear in mind that the peak label and the multiplet boxes will show the applicable atom numbers of the Predict.



From the 1H prediction table is also possible to introduce new coupling constants. To do that just click on the 'Ungroup' button  to do not group magnetically equivalent protons and next click on the 'New J' button 

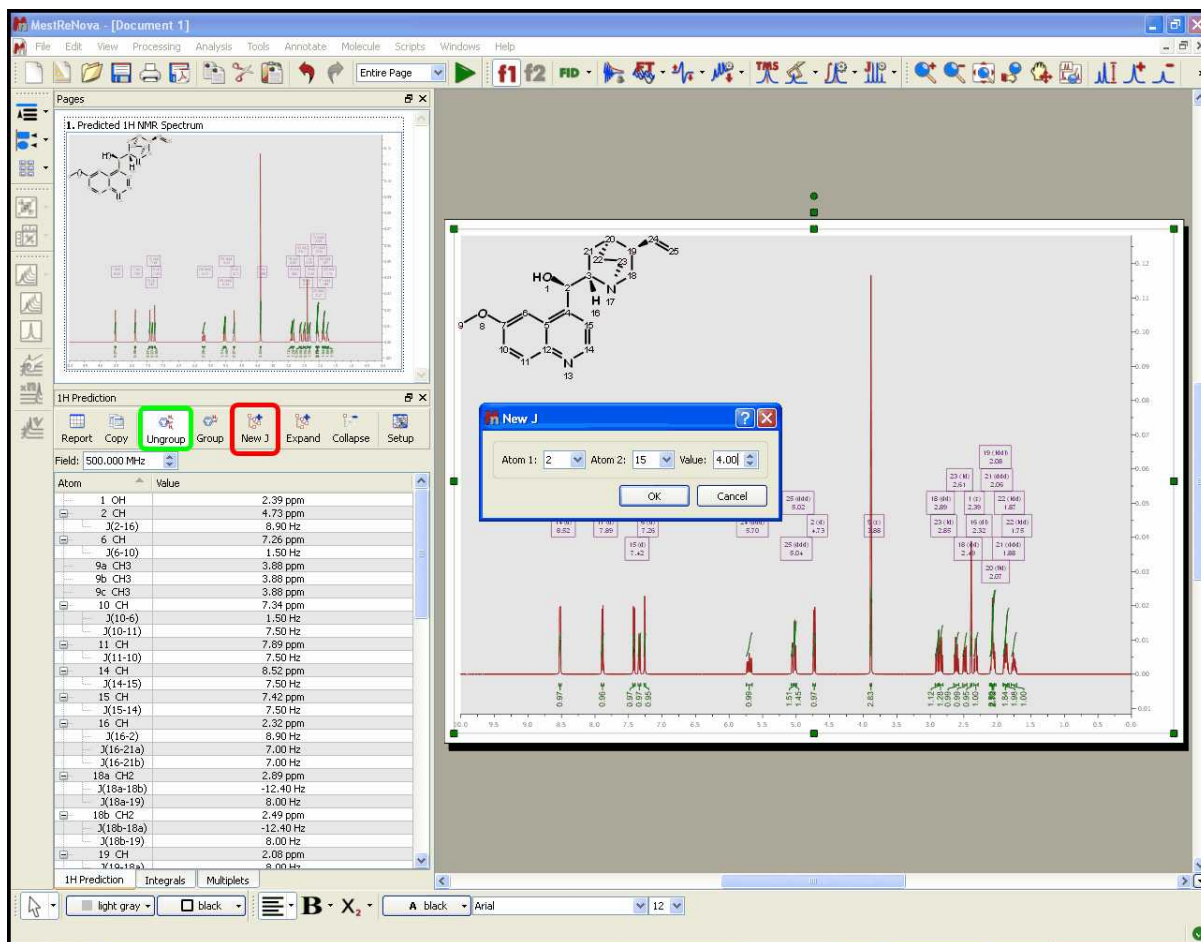

After that, the 'New J' dialog box will be displayed and you will only need to select the atoms involved in the coupling and the value of the new coupling constant. Click on OK and the new coupling constant will be added to the spectrum and also to the prediction table.

Finally, to know the "predicted assignment", just hover the mouse over the desired atom, (so that it becomes highlighted in a red box) and the corresponding signal in the spectrum will automatically highlight in blue (increasing slightly its intensity); or vice versa (hovering the mouse over the peak will highlight the applicable atom on the molecular structure).

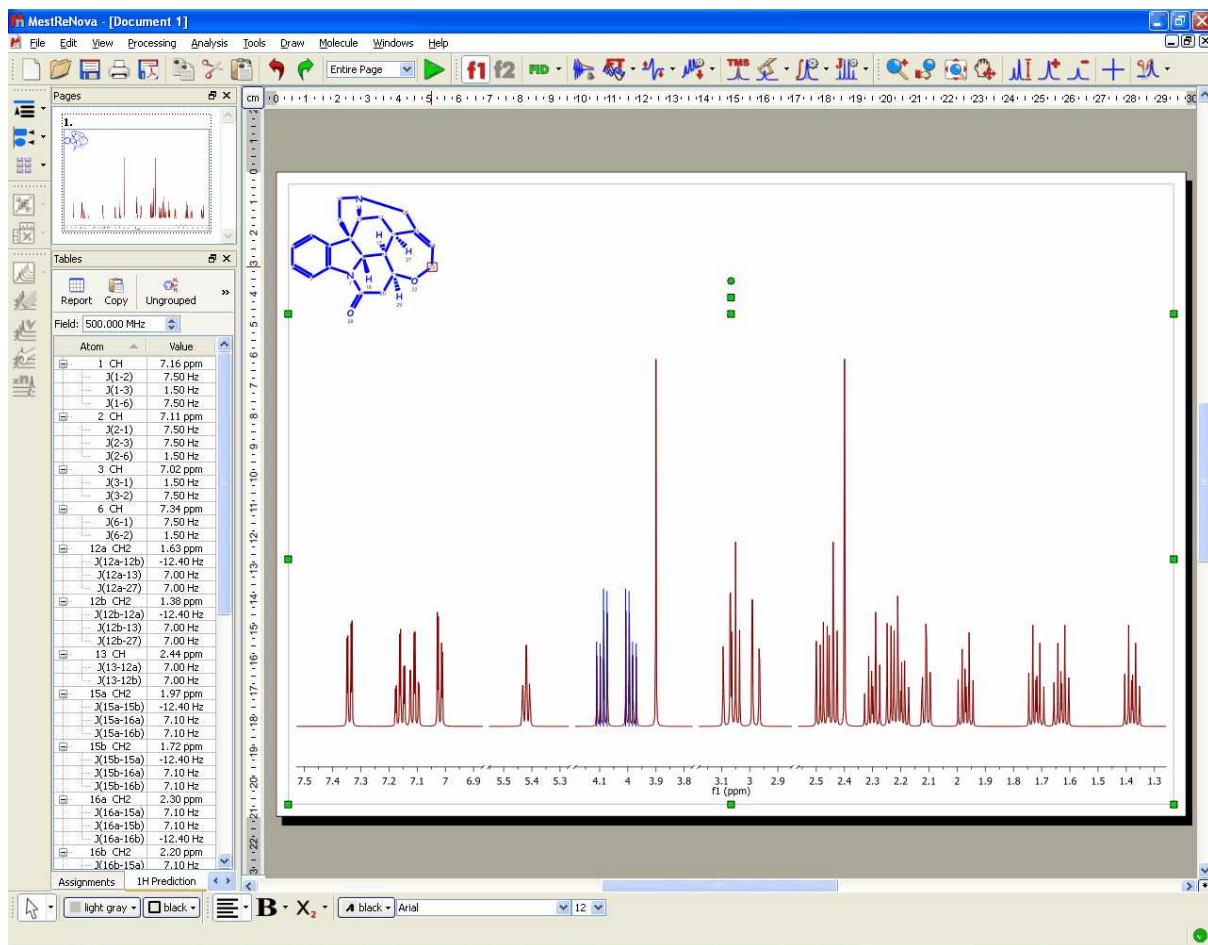

It will be possible to graphically modify the chemical shift of the predicted signals just by clicking&dragging over the prediction label:

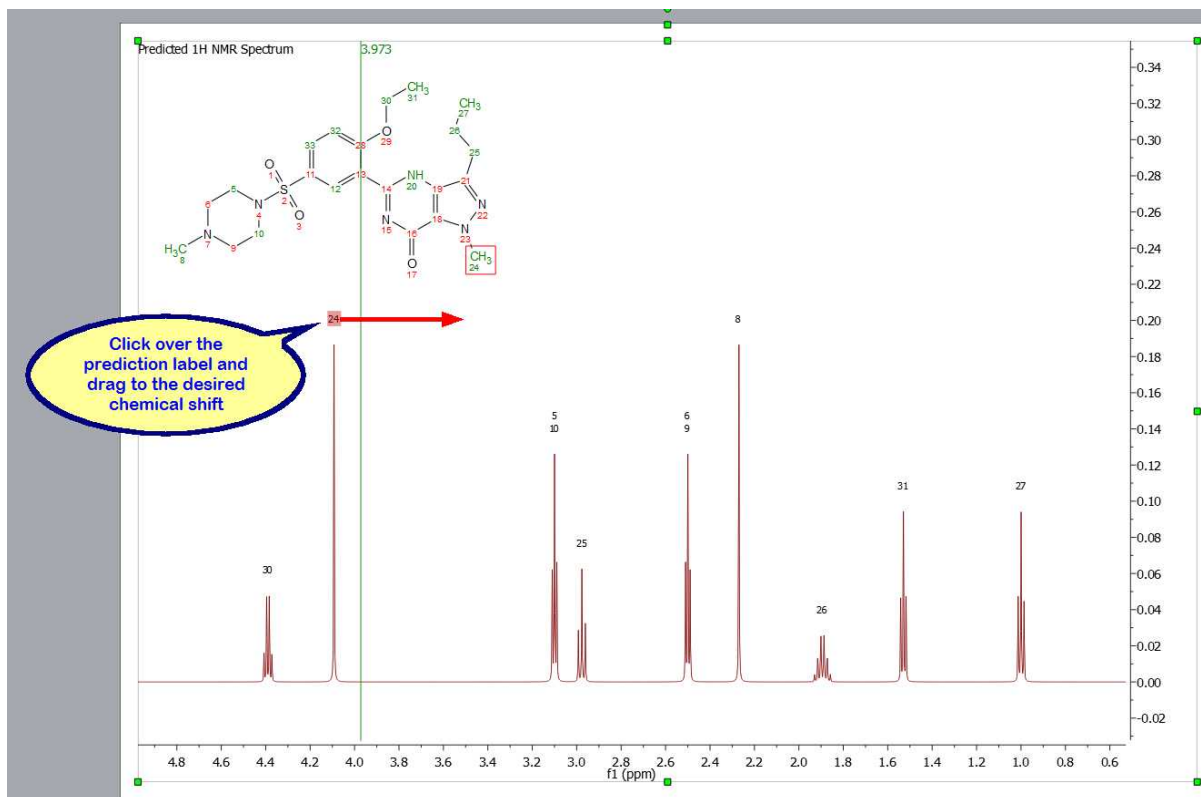

It will be also possible to change the predicted coupling constants just by showing the multiplet tree from the ['Multiplets Properties'](#) dialog box and clicking&dragging:

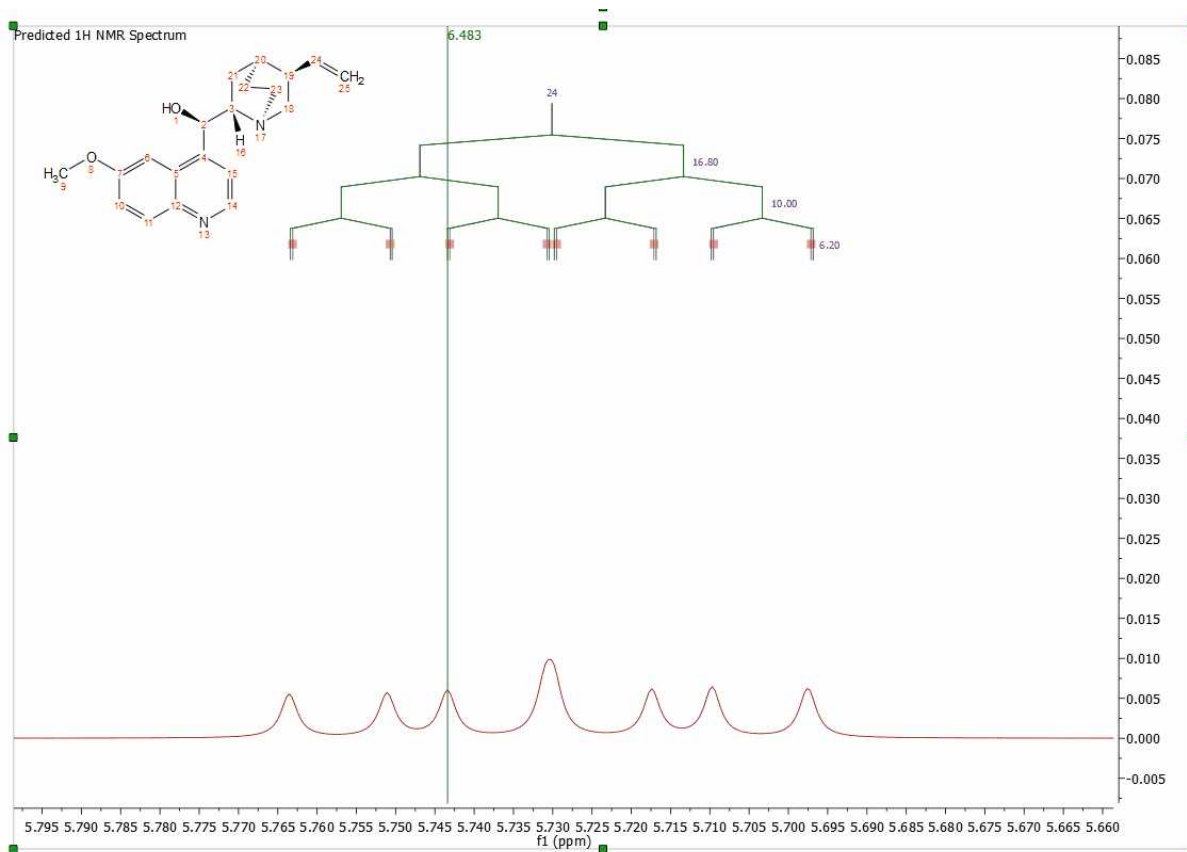

Please bear in mind that NMR Predict Desktop also includes the calculation of heteronuclear (HF, HP, CF and CP) couplings:

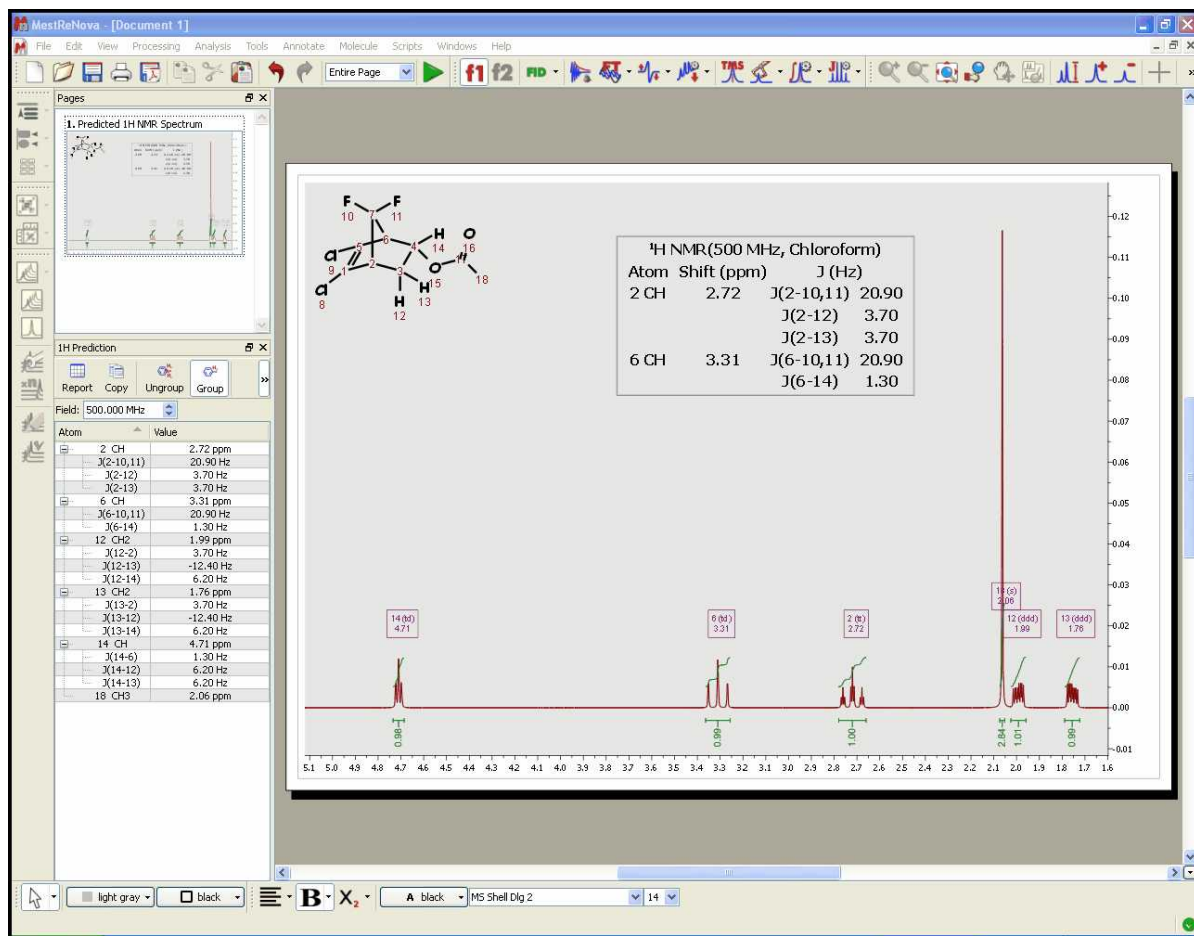

If you need the ¹³C-NMR predicted spectrum, follow the same instructions but selecting the options for '13C' (be sure that you select the correct tab for 13C in the 'NMR Predictor Box' dialog, red square in the figure below). As you can see in the 'NMR Predictor Option' box below, you can select the limits, the number of points, the frequency and the line width of the spectrum. It is also possible to predict 'DEPT' (CH and CH₃ up and CH₂ and Quaternary carbons down) and spectra with only protonated carbons (DEPT 45) by checking the applicable boxes. If you want to get a DEPT 135, you must check both boxes.

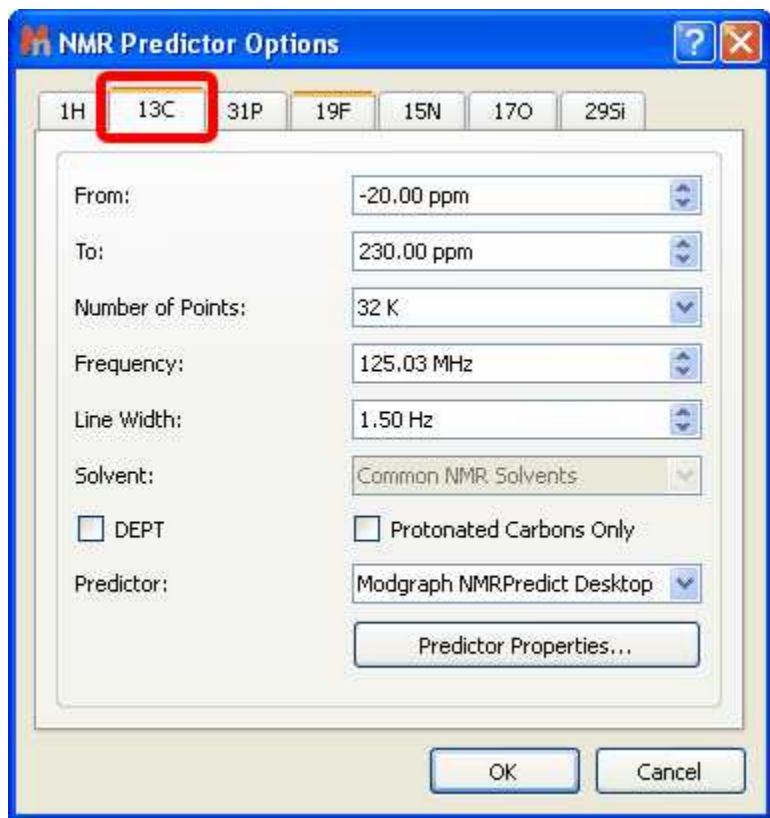

Here you can see an example of a DEPT 135 prediction:

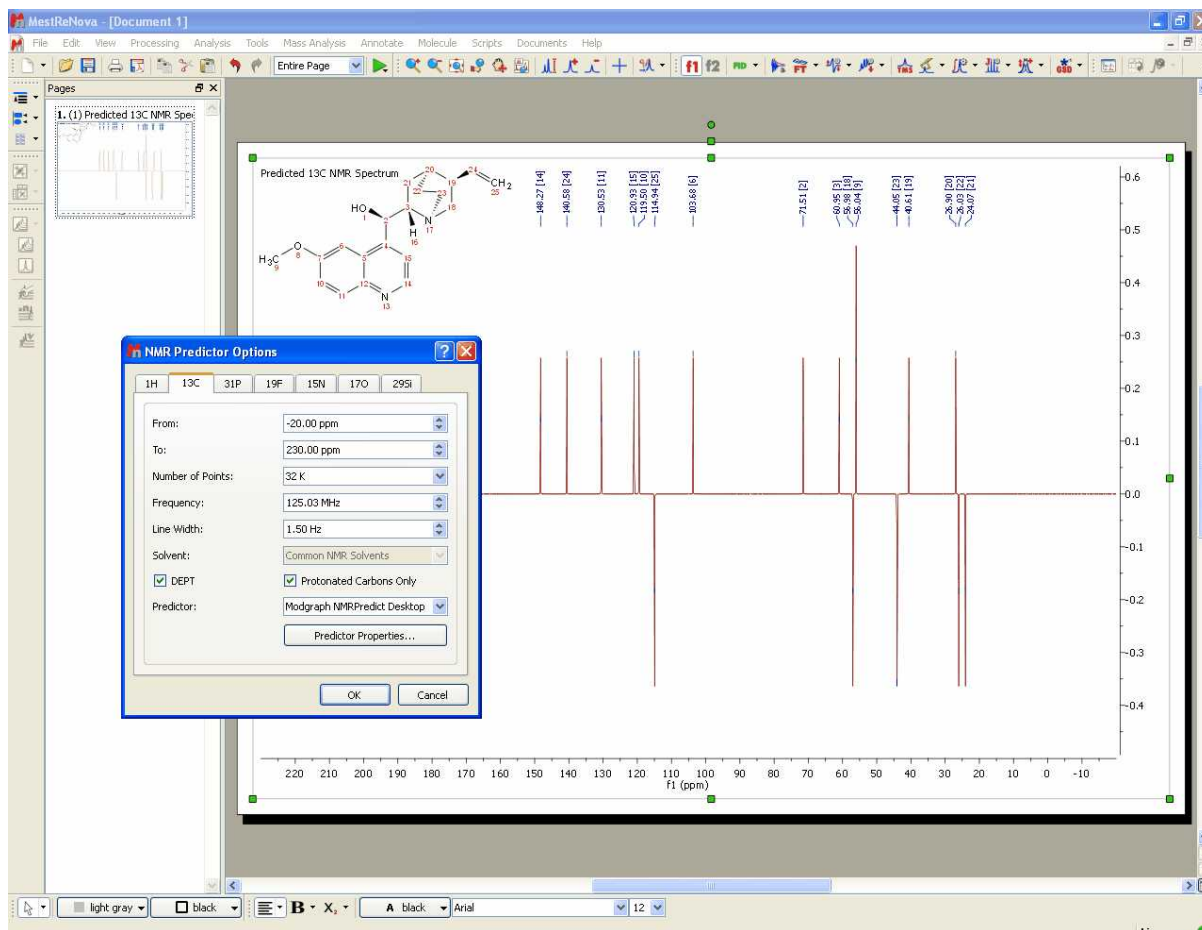

Please bear in mind that it will be also possible to predict HSQC spectra by following the menu 'Predict/HSQC Spectra':

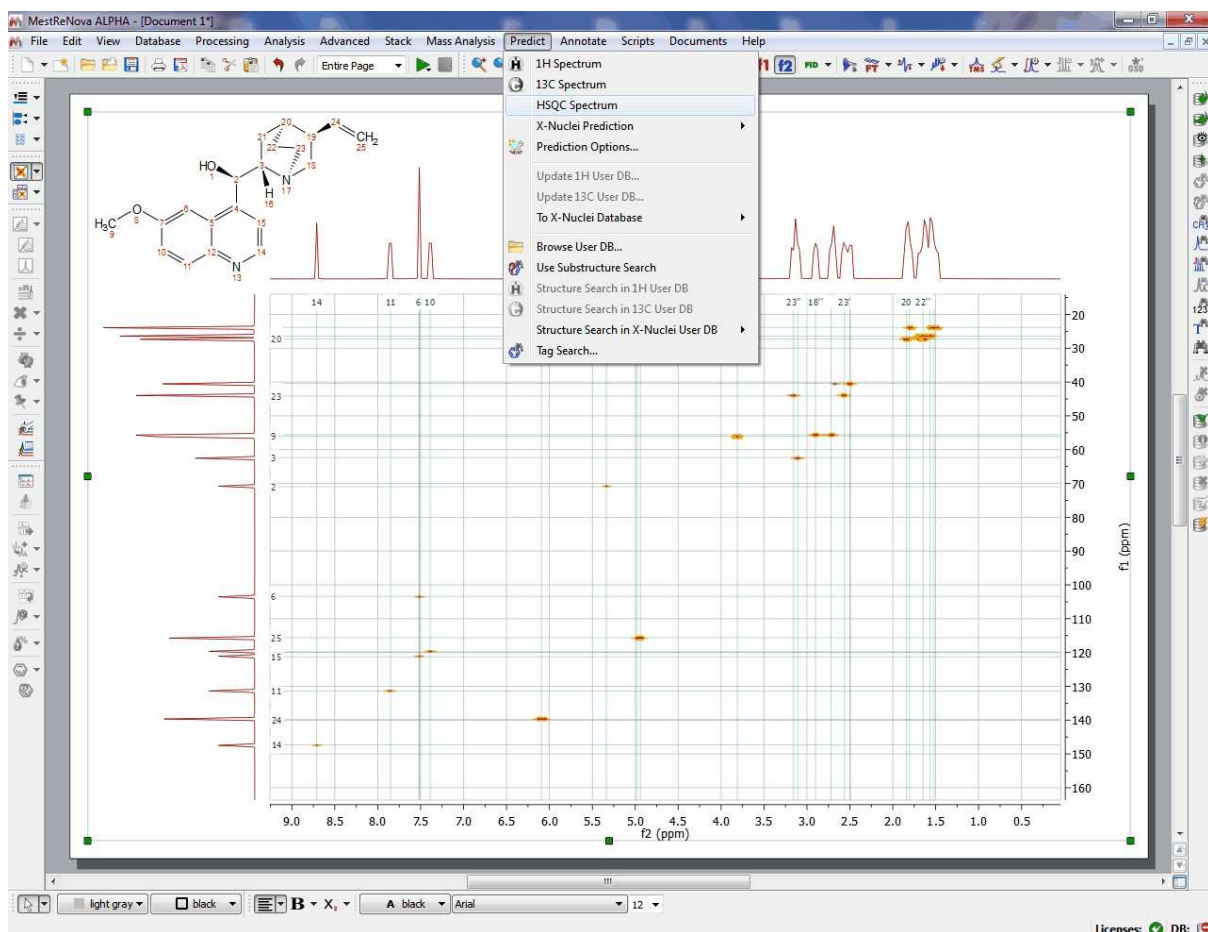

The same procedure will be followed to run X-Nuclei predictions ^{31}P , ^{19}F , ^{15}N , ^{17}O , ^{29}Si (under the menu 'Predict/X-Nuclei Predictions'):

-  Predict ^{15}N Spectrum
-  Predict ^{17}O Spectrum
-  Predict ^{19}F Spectrum
-  Predict ^{29}Si Spectrum
-  Predict ^{31}P Spectrum

And here you can see an example:

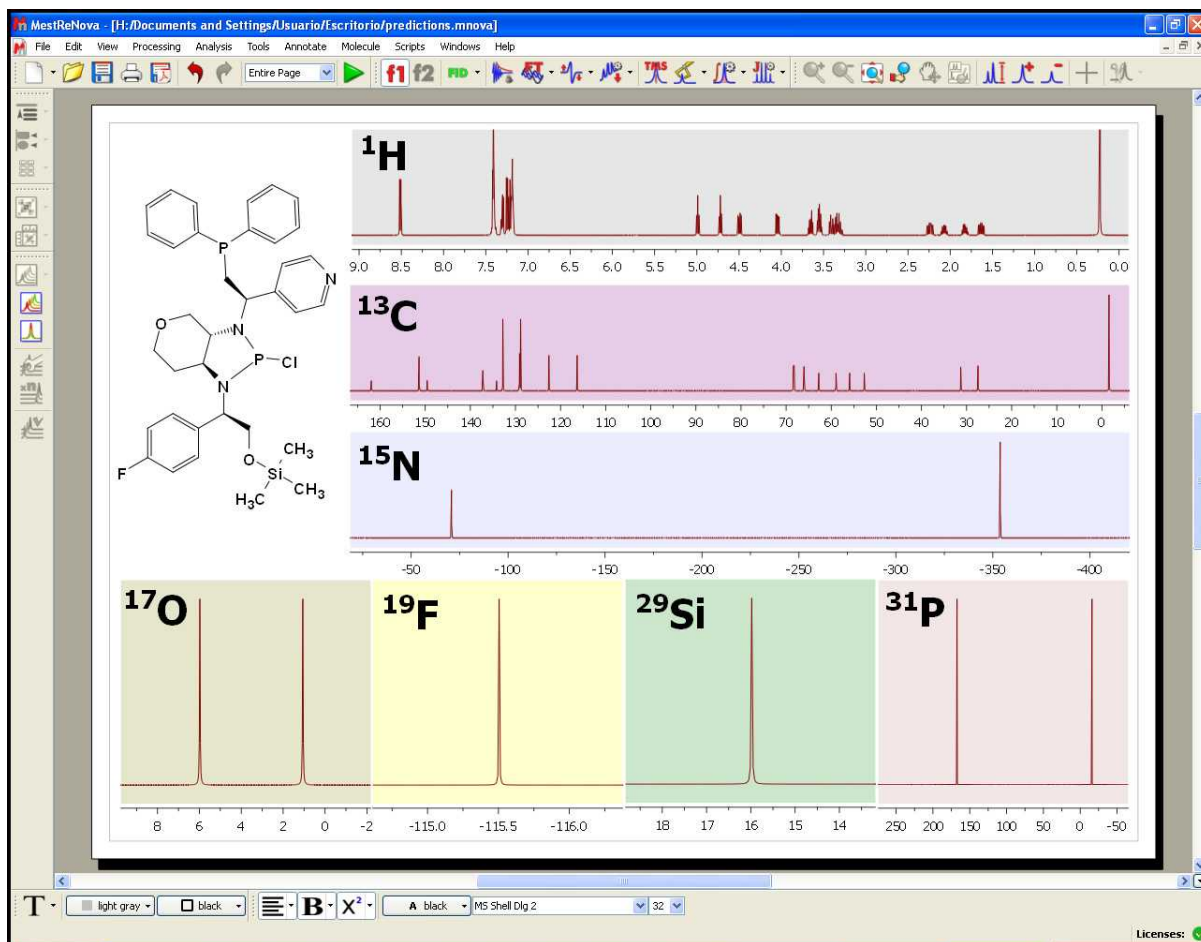

ATTENTION

Take advantage of the full quantum mechanics simulations available within the Mnova GUI. Display spectra and simulate higher order effects and strong coupling for any size spin systems

You can see (in the picture below) the higher order effects observed in the ^1H predicted spectrum of the cholesterol:

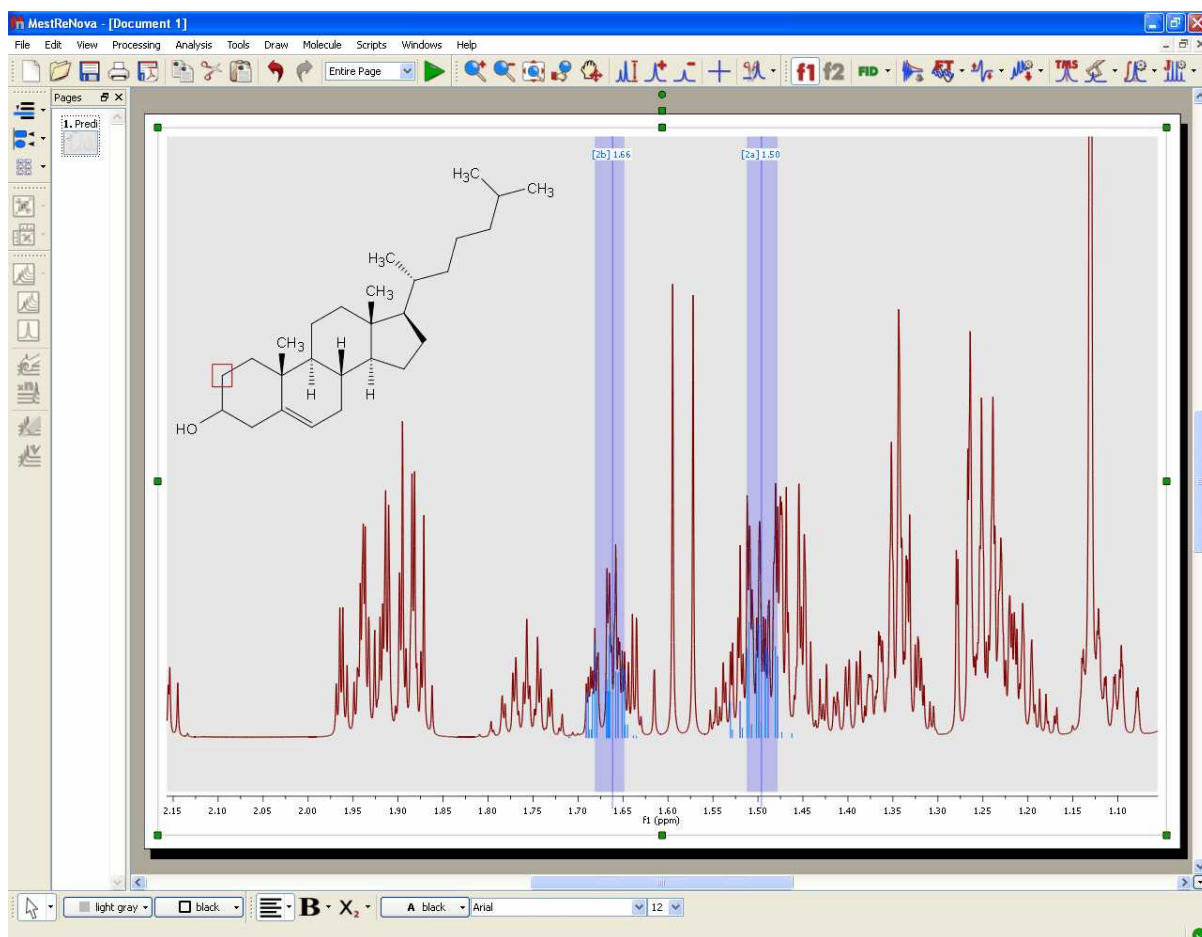

See also:

[How to predict a spectrum with NMRPredict Desktop?](#)

9.9.1.2 Predict & Highlight

You will find the quinine datasets in the installation folder of Mnova (under the examples/datasets folder)

This feature will calculate in the background a simulation of the spectrum of the molecular structure present in the spectral window, highlighting the expected chemical shifts when the user hover the mouse over a proton or a carbon. This tool will be very useful to help the user in the process of assigning of NMR spectra.

The user will be able to use this tool with 1D and HSQC NMR spectra just by pasting the applicable molecular structure (quinine, in this example) over the spectrum and following the menu 'Analysis/ Predict & Highlight', as is shown in the picture below:

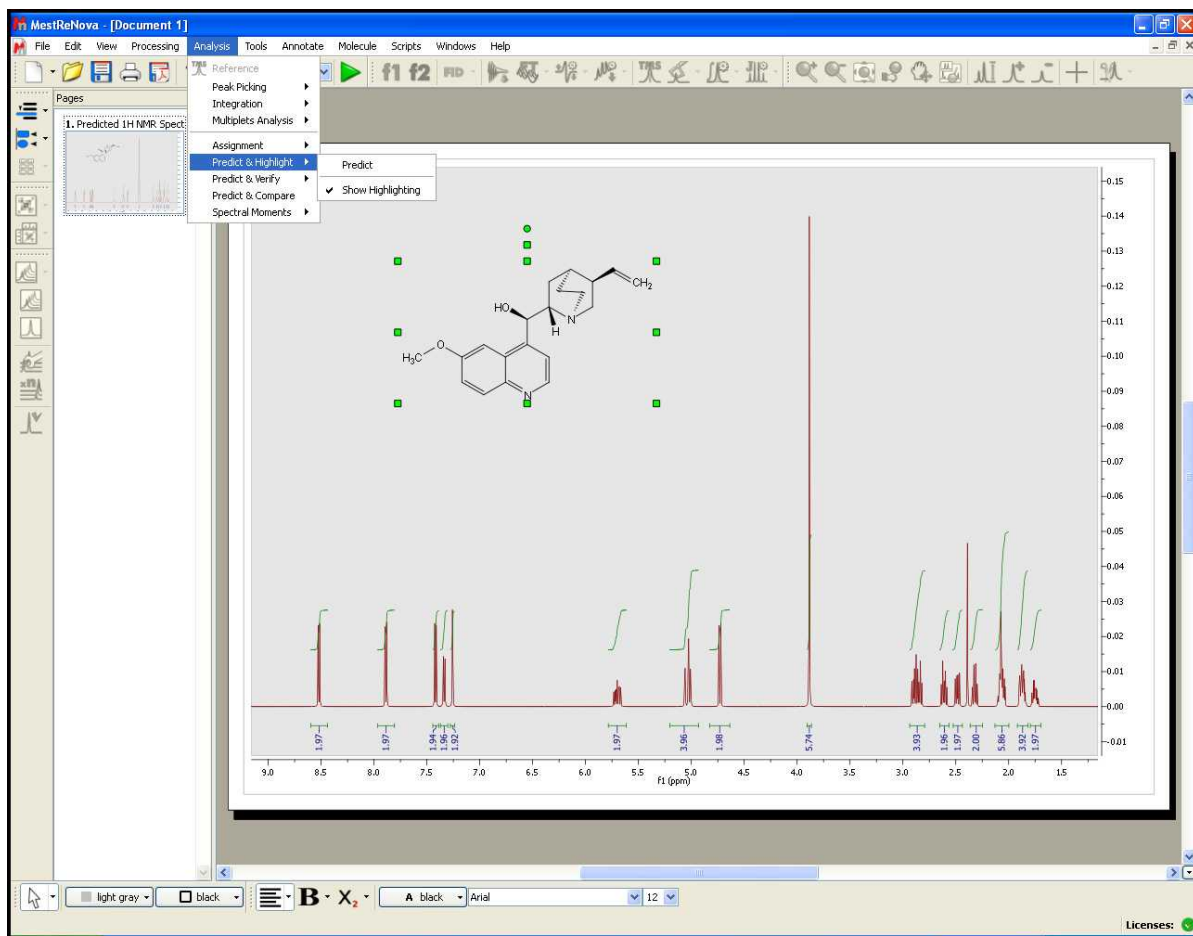

The algorithm of the simulation carried out in the background will be the selected in the 'Predict/Prediction Options' menu.

The same feature can be applied by selecting the molecule on the Compounds Table.

After having applied this feature, the user will be able to notice that hovering the mouse over the atom will highlight the applicable simulated area in the spectrum. So the user will know that this signal will correspond with the proton of the carbon number 9 in the quinine.

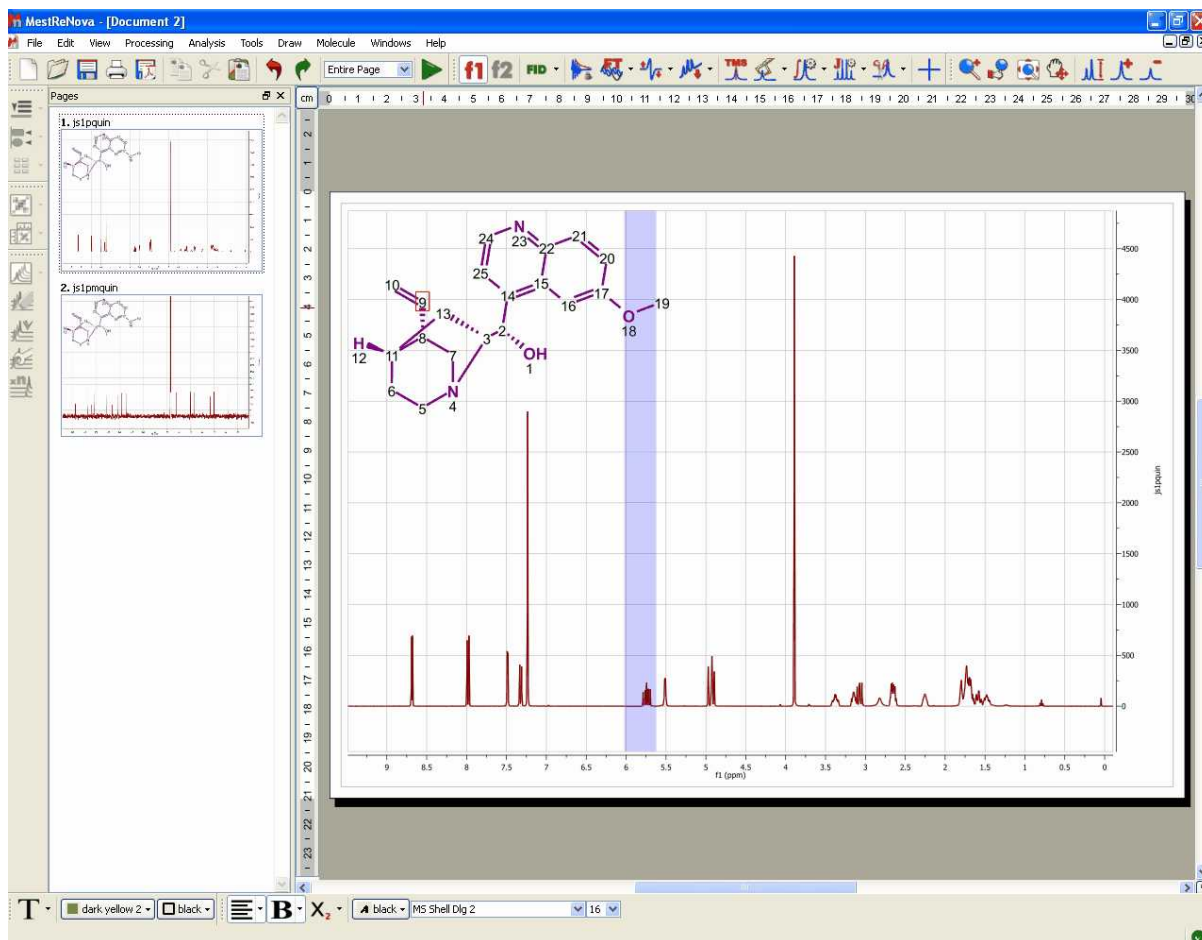

The user will be able to apply the same feature with the ^{13}C NMR spectra, as is shown in the picture below:

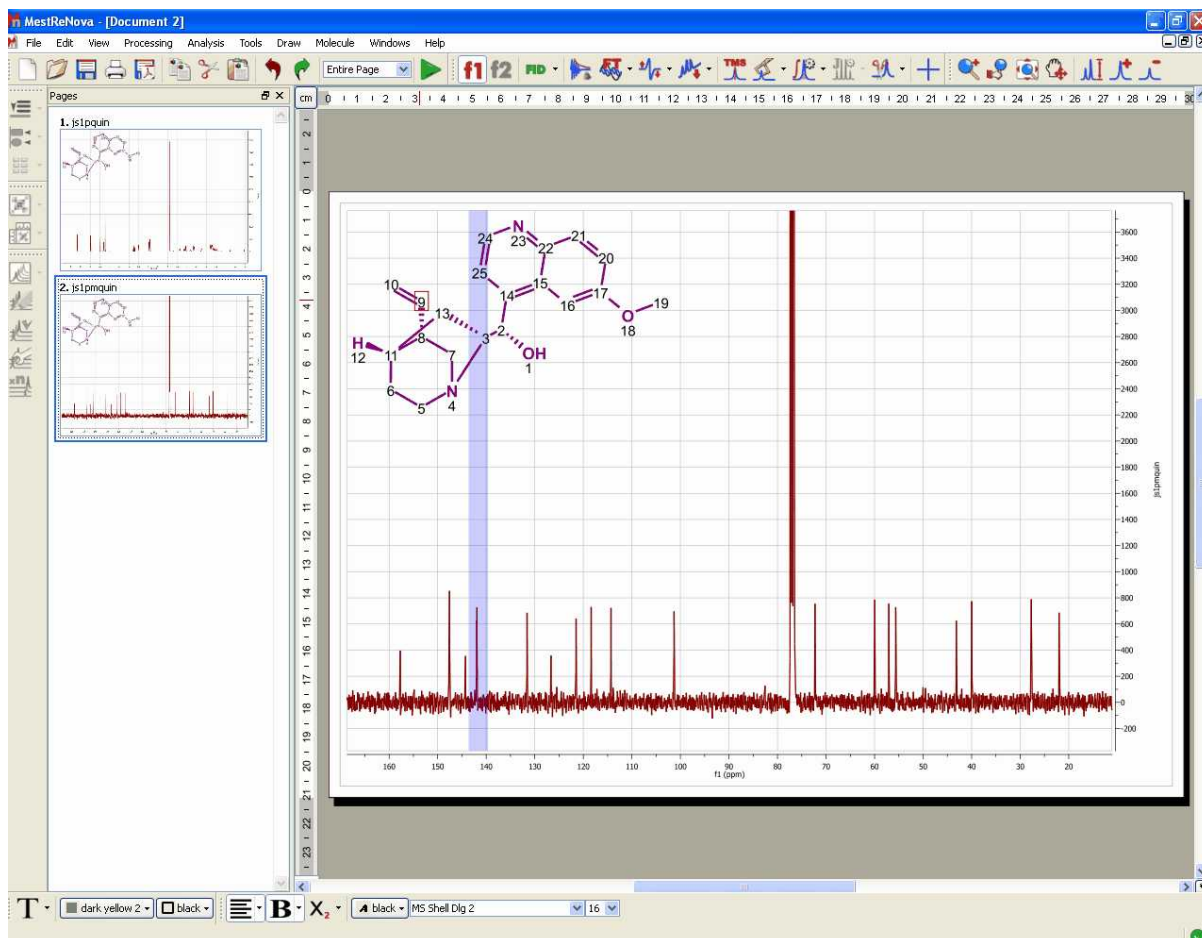

Here you can see an example with a HSQC:

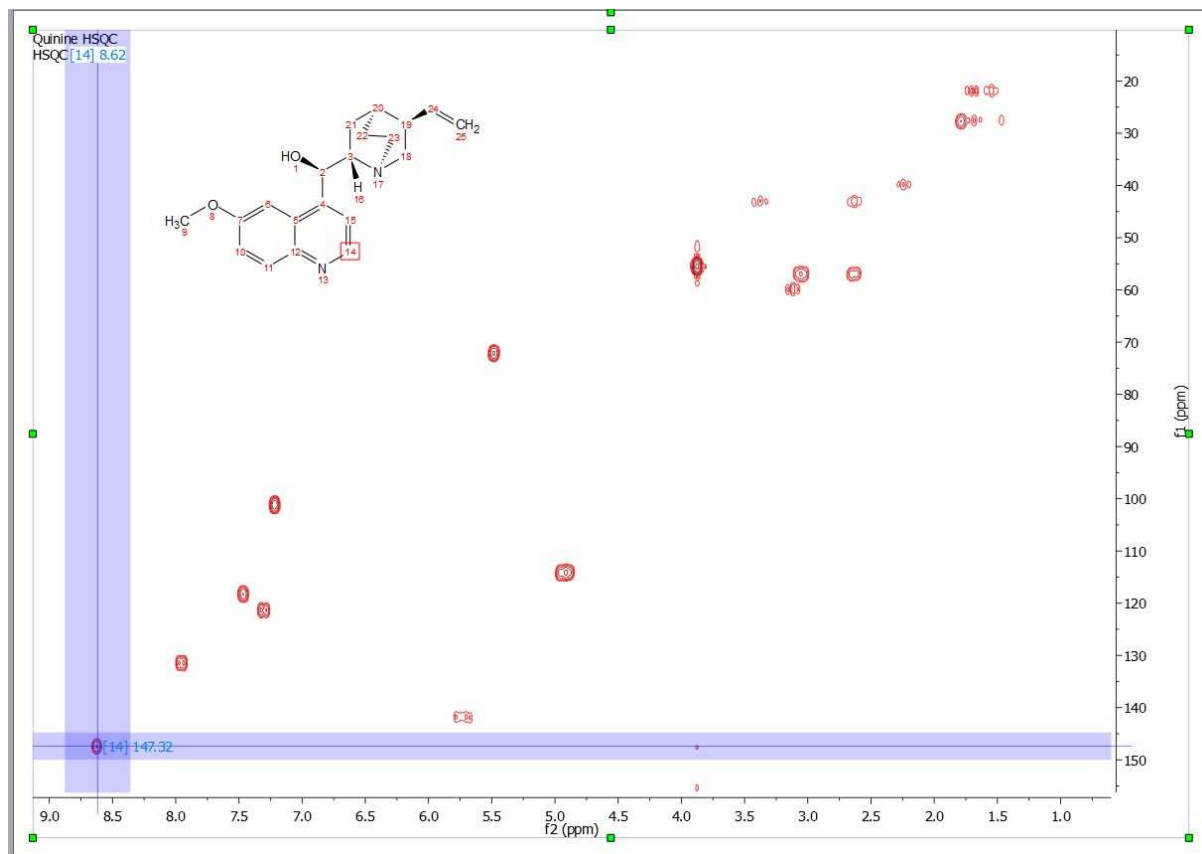

9.9.1.3 Predict & Compare

This feature will display in stacked mode, the experimental dataset and a simulation of the spectrum of the molecular structure present in the spectral window, highlighting the expected chemical shifts when the user hovers the mouse over a proton or a carbon. This tool can be used of assistance in the process of assigning ^1H and ^{13}C NMR spectra.

The user will be able to use this tool with ^1H and ^{13}C NMR spectra just by pasting the applicable molecular structure (quinine, in this example) over the spectrum and following the menu 'Analysis/Predict & Compare'. The same feature can be applied by selecting the molecule from the Compounds Table (without a need for having the molecule pasted on the relevant page, affording users the flexibility to run different predictions without having to generate many instances of the molecule on their report).

After the prediction is run, Mnova synthesizes the corresponding ^1H -NMR spectrum using a rigorous full quantum mechanics method taking into account any second order effect present in the predicted spin(s) systems(s).

For example, in the figure below, you can see the results of running a prediction and comparing the resulting ^1H spectrum with its experimental counterpart:

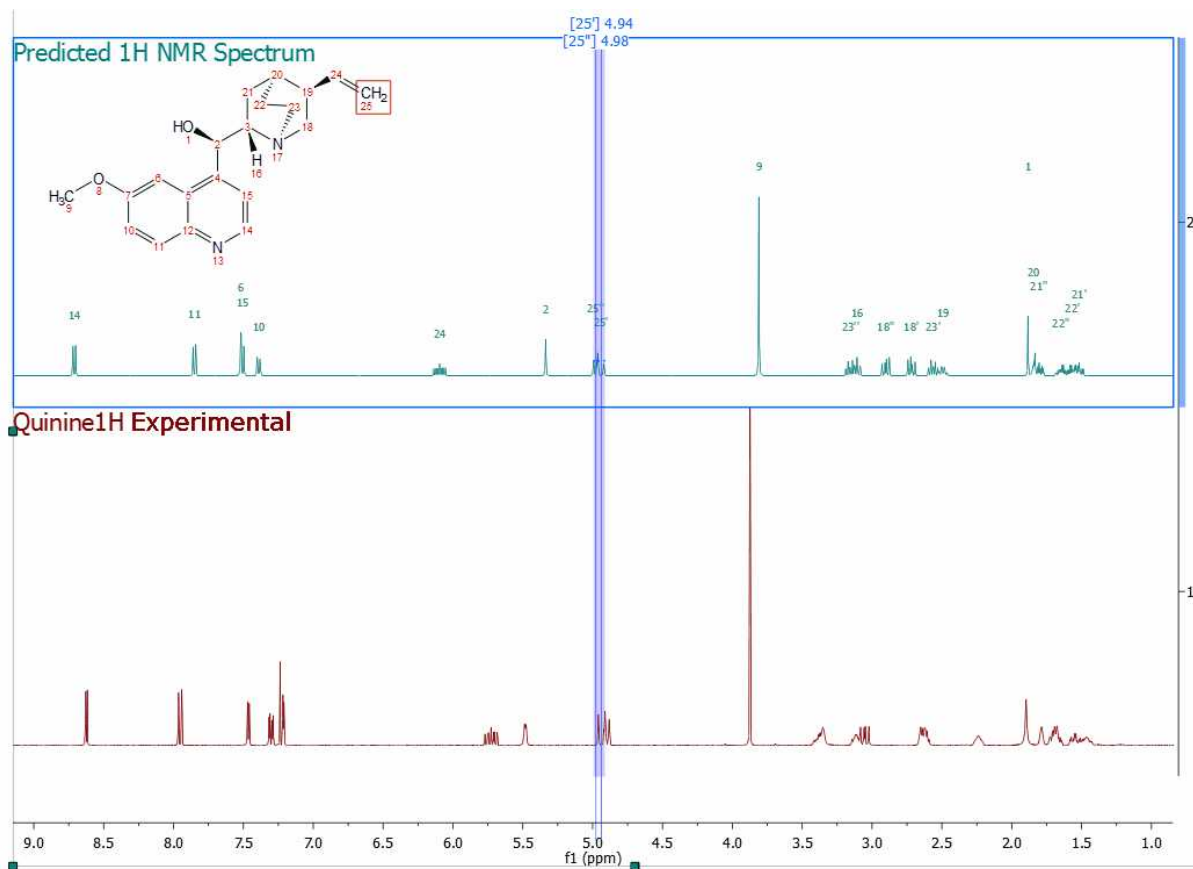

As you can see, you will get the predicted spectrum on top with the proton assignments labels.

Hovering the mouse over the assignment labels and clicking&dragging will change the chemical shift in real time:

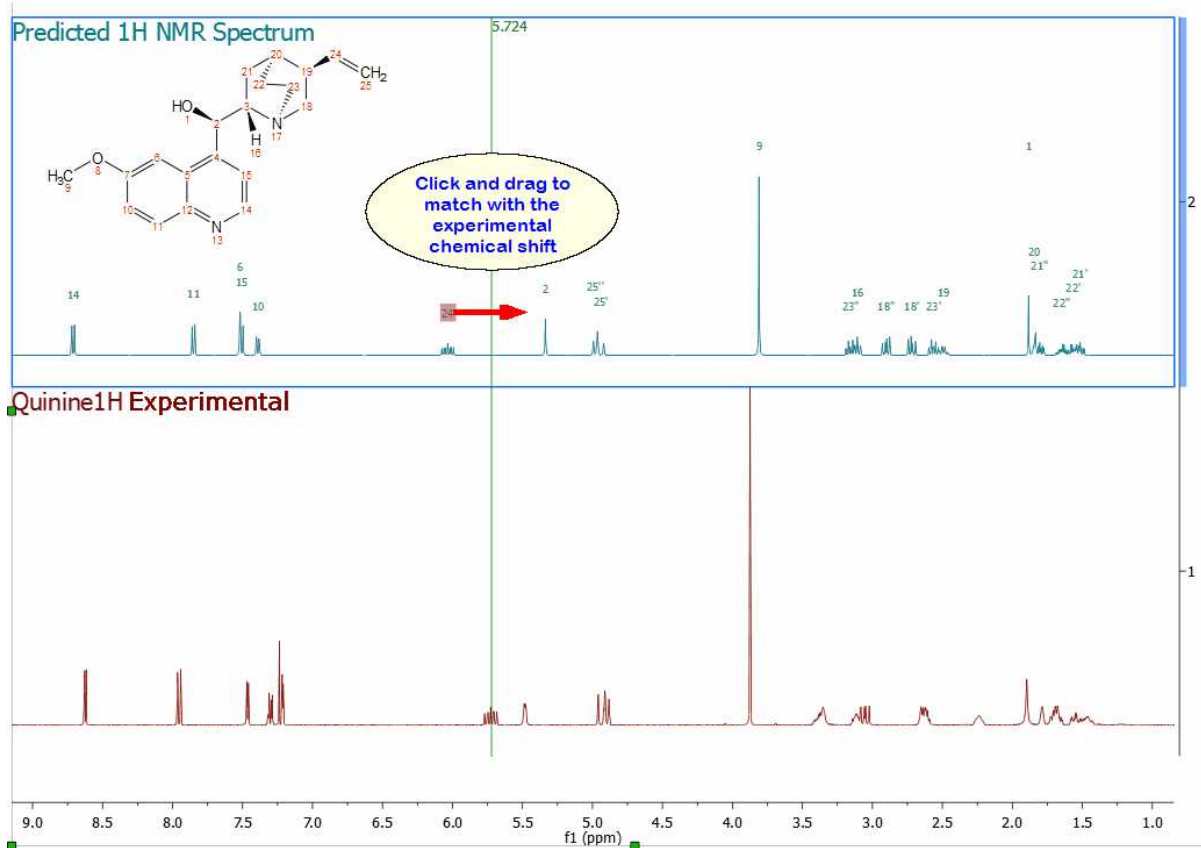

Even you can graphically modified the predicted coupling constants (just by clicking&dragging) if you have selected the option to show the coupling tree in the Multiplet properties

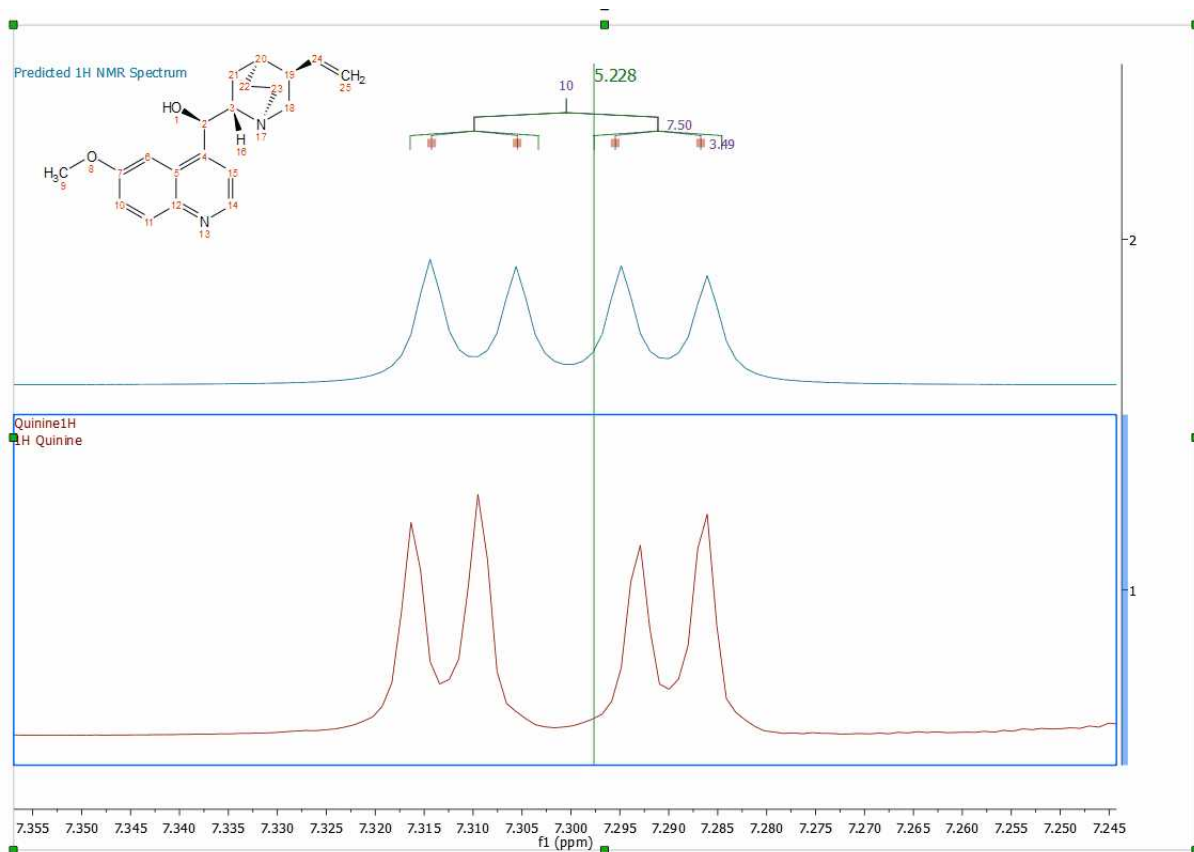

Once you have modified the prediction, you can update those changes to the [prediction Database](#) to enhance the prediction results of similar structures. To do it, just right click on the molecular structure and select 'Update Prediction DB':

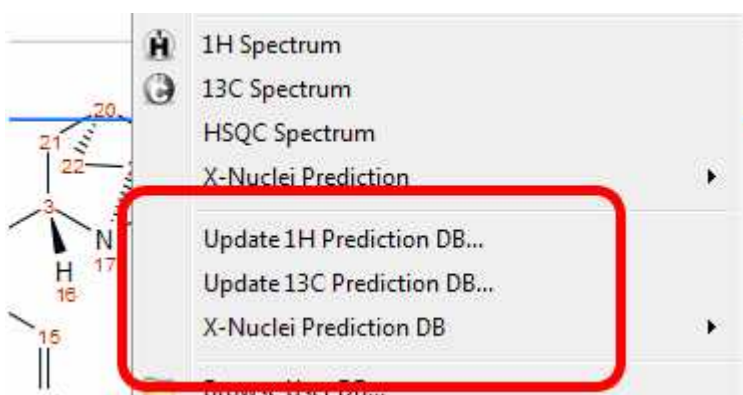

9.9.1.4 Predict & Verify

This chapter describes a new feature to validate molecular structures, which is based on the concurrent analysis of two simulated 1D (^1H and ^{13}C) NMR spectra and a real 2D NMR one-bond correlation spectrum, such as HMQC or HSQC (experiments which correlate the chemical shift of the proton with the chemical shift of the directly bonded carbon).

The procedure to apply a **Visual Verification** with Mnova is very easy, just load your HSQC or HMQC spectrum, and follow the menu: 'Analysis/Predict & verify/HSQC' with the applicable molecular structure pasted on the spectral window as is shown in the pictures below:

1st: Load the HSQC or the HMQC spectrum in Mnova:

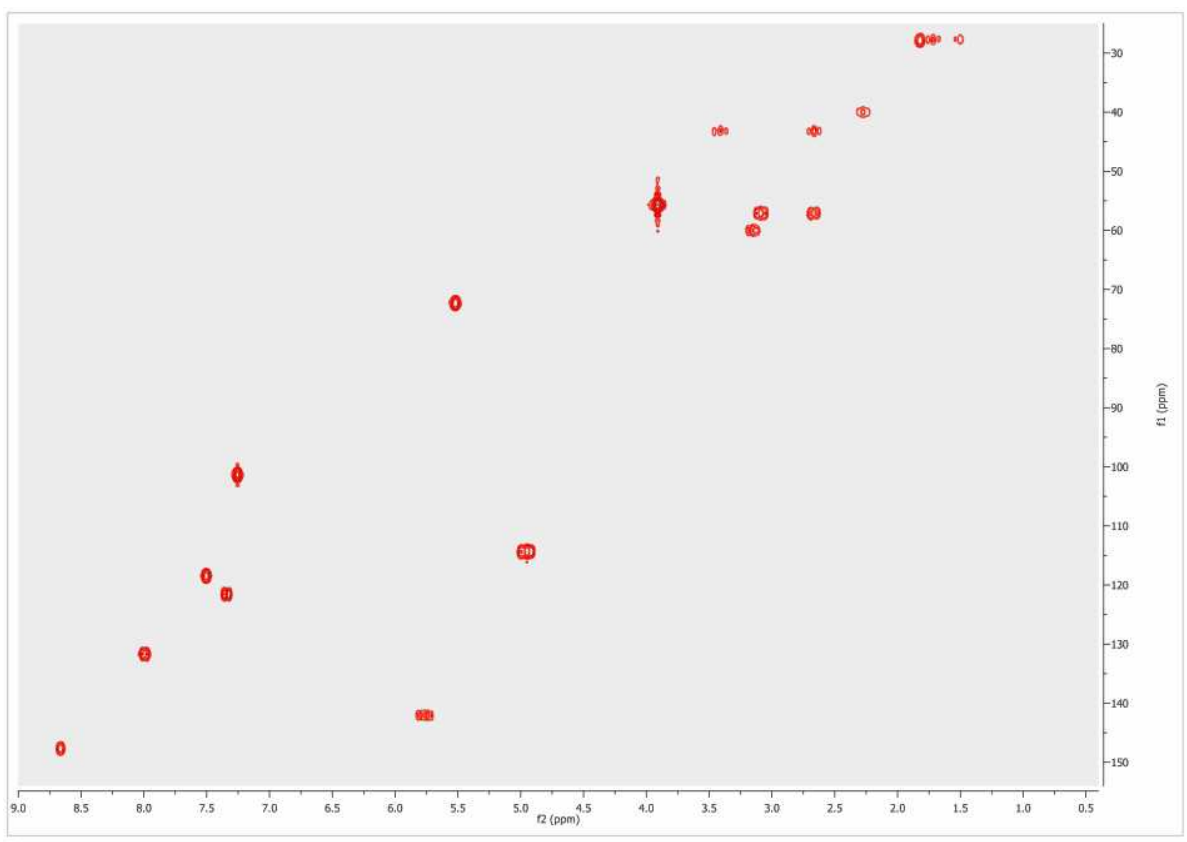

2nd: Paste (or load) the applicable molecular structure. Bear in mind that molecular structures can be imported as a **.mol** file by simply using the 'Open' command exactly in the same way as this would be applied to a spectrum. Keep in mind that you are also able to copy & paste structures from **ChemDraw**, **ChemSketch** and **IsisDraw**.

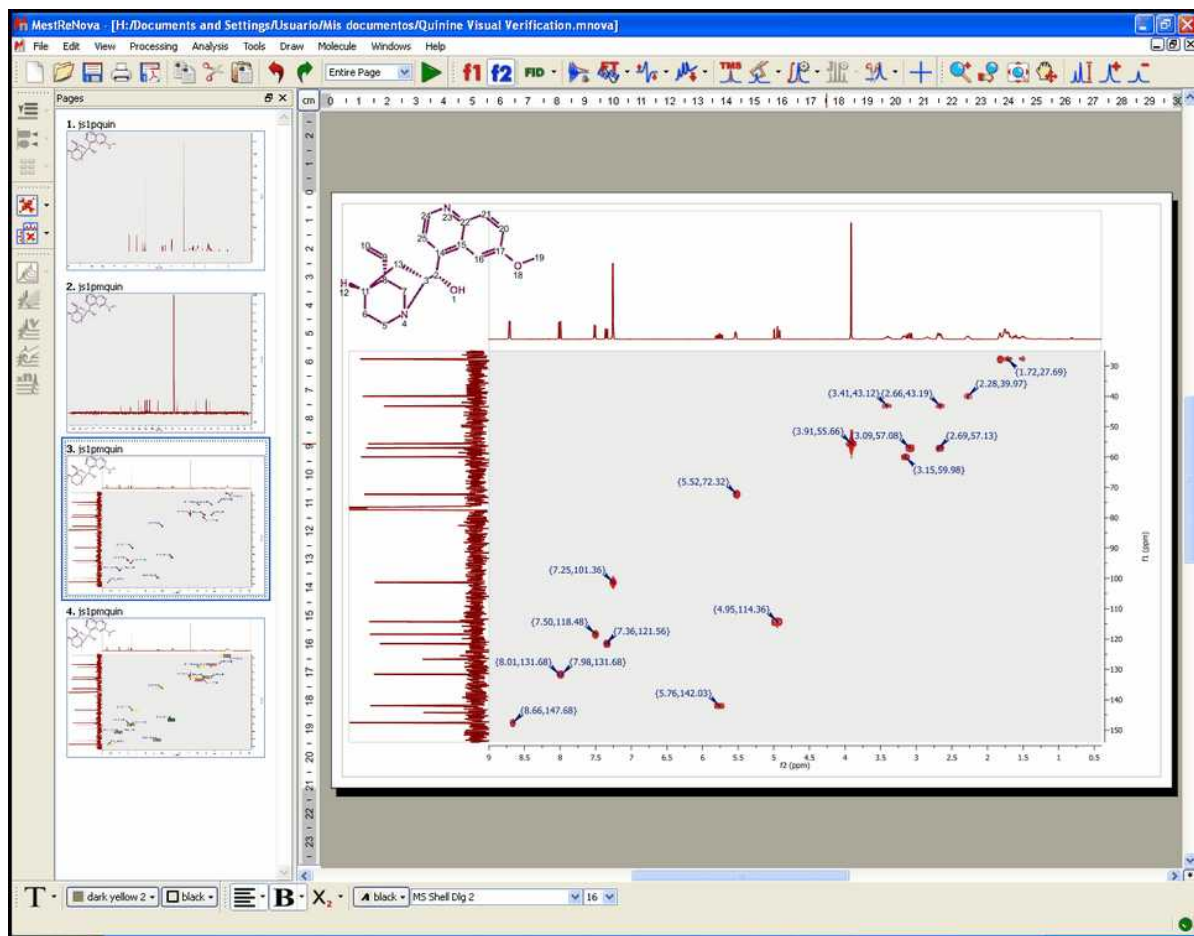

3rd: Follow the menu: 'Analysis/Predict & Verify/HSQC' to obtain the corresponding analysis:

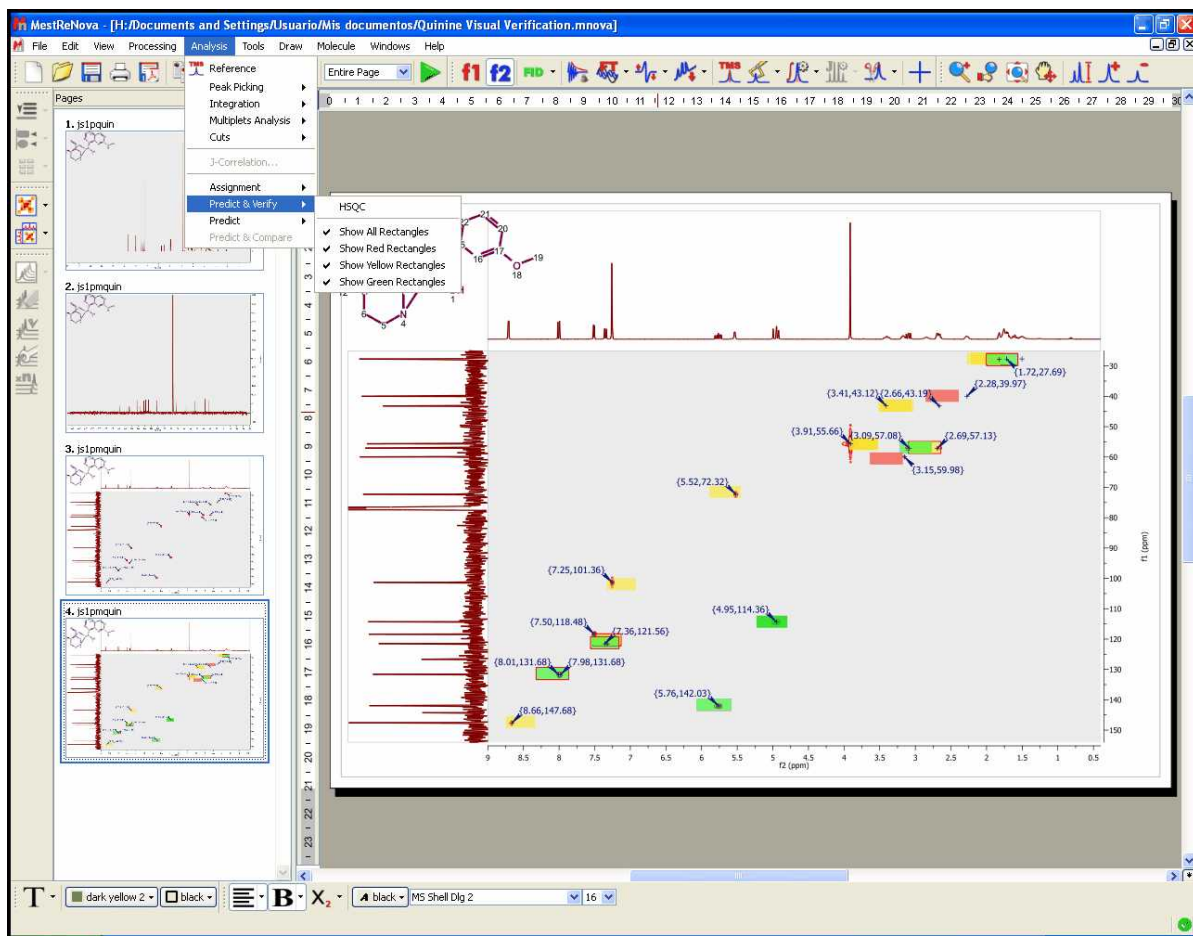

The same feature can be applied by selecting the molecule in the Compounds Table.

As you can see in the picture above, green, yellow and red rectangles will be obtained in the analysis.

A green rectangle will appear when the simulated value fits with the experimental one (the experimental value falls within a rectangular window, drawn around the simulated value, with dimensions of 0.2 ppm along the proton dimension and 2 ppm along the carbon dimension). A yellow rectangle will be displayed when an experimental peak falls within a window which is between 0.2 and 0.4 ppm along the proton dimension and 2 and 4 ppm along the carbon dimension. Finally, the red rectangles are displayed when no experimental peak is found within the latter rectangle, with the simulated value at its center and dimensions of 0.4 ppm along the proton dimension and 4 ppm along the carbon dimension.

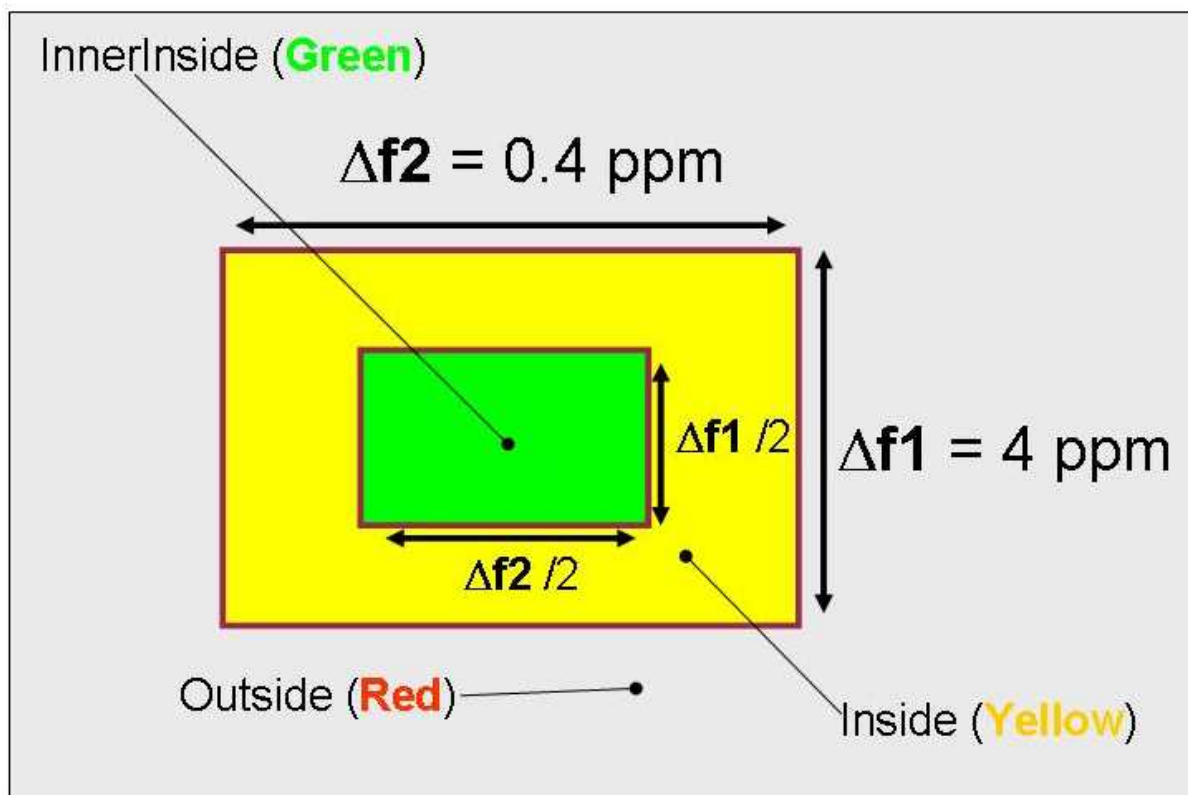

For example, if we have a real cross peak in the HSQC spectrum at (1.00, 10.0) ppm and a simulated value of (1.05, 10.2) ppm, then we shall obtain a green rectangle, because there is a experimental peak within the rectangle with a predicted peak at its center and sides of 0.2 ppm along the proton and 2 ppm along the carbon dimensions, which we will call 'inner inside'. If we would have a simulated value of (1.25, 11.0) ppm, then we would get a yellow rectangle drawn around the simulated value, as the experimental peak values would fall outside the 'inner inside' but within the area, drawn around the predicted peak, with sides of 0.4 ppm along the proton dimension. In this case the carbon simulation would be fine, but we would get a yellow rectangle due to the deviation in the proton prediction. If the simulated value for this cross peak was (1.41, 15.0) ppm, then we would obtain a red rectangle.

Finally, we shall get a rectangle with a red border when more than one experimental cross peak falls within the green or yellow rectangles drawn around a predicted peak, as is shown in the picture below:

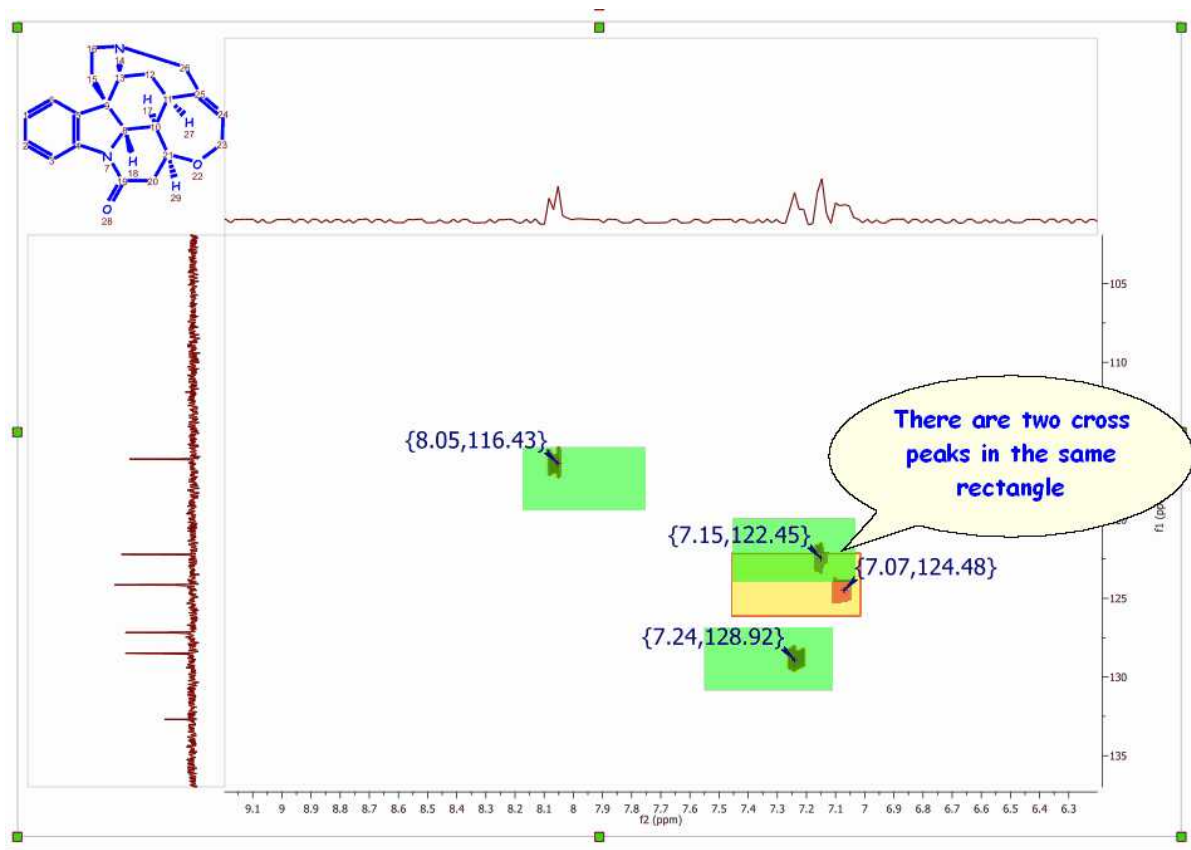

The user also has the ability to display any combination of rectangles, such as only red rectangles or green and yellow rectangles, for example. These options are available from the 'Analysis/Predict & Verify' menu.

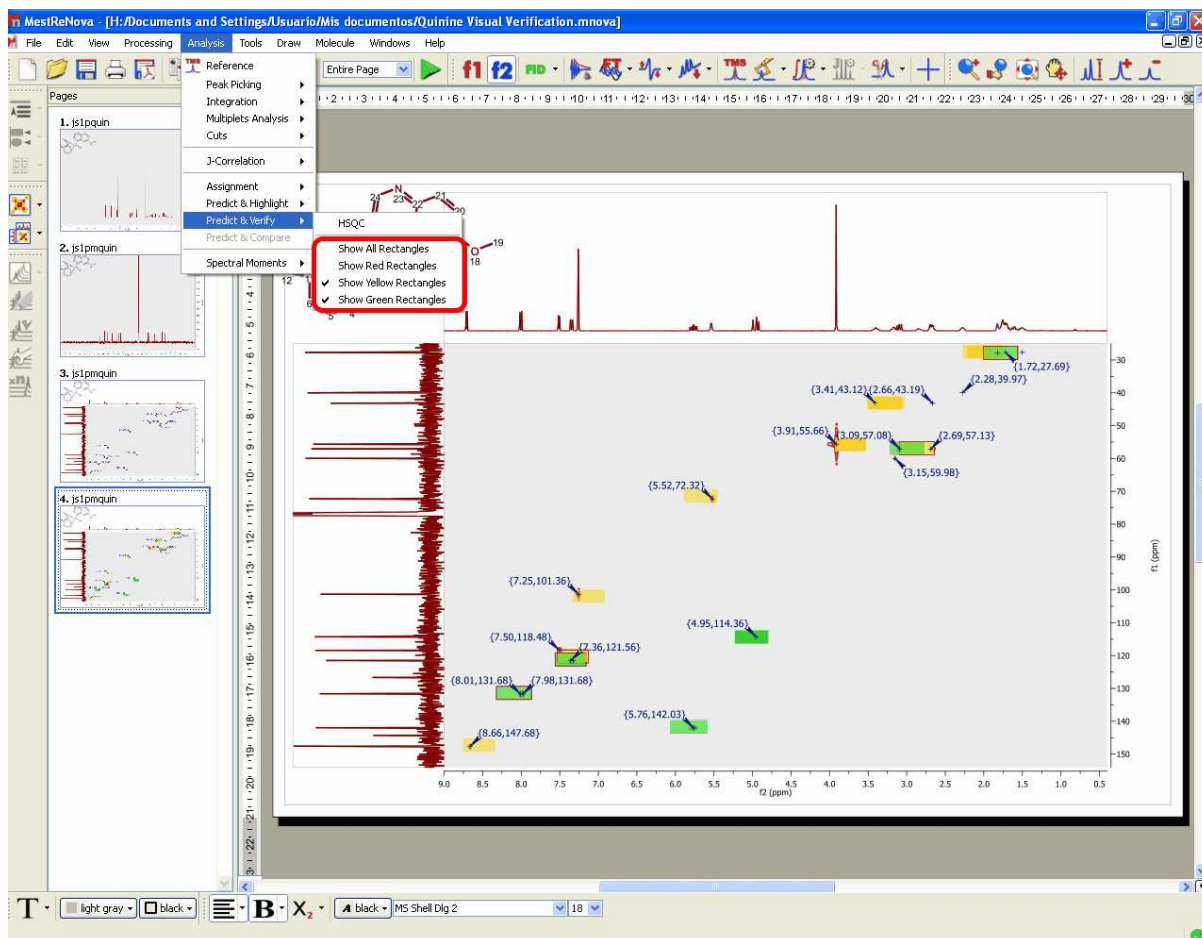

Bear in mind that the results reported by visual verification will depend on the prediction algorithm used in the spectral simulation. The user will be able to change this algorithm by following the menu: 'Predict/Prediction Options/Predictor Properties'.

9.9.1.5 Prediction Database

This feature will allow the user to build databases with experimental assigned spectra which can be used to enhance the prediction results of similar structures.

It will be possible to build ^1H , ^{13}C and X nuclei (^{31}P , ^{19}F , ^{15}N , ^{17}O , ^{29}Si) NMR databases from any Mnova document containing a molecular structure with the resulting assignments.

Building the database is really easy, just open your NMR dataset with the molecular structure; make the [assignments](#) and follow the menu 'Predict/Update 1H Prediction DB' (It will be also possible to update the prediction database from the Well Plates view of the DB plugin just by right clicking on any of the plates, or even directly from a predicted spectrum).

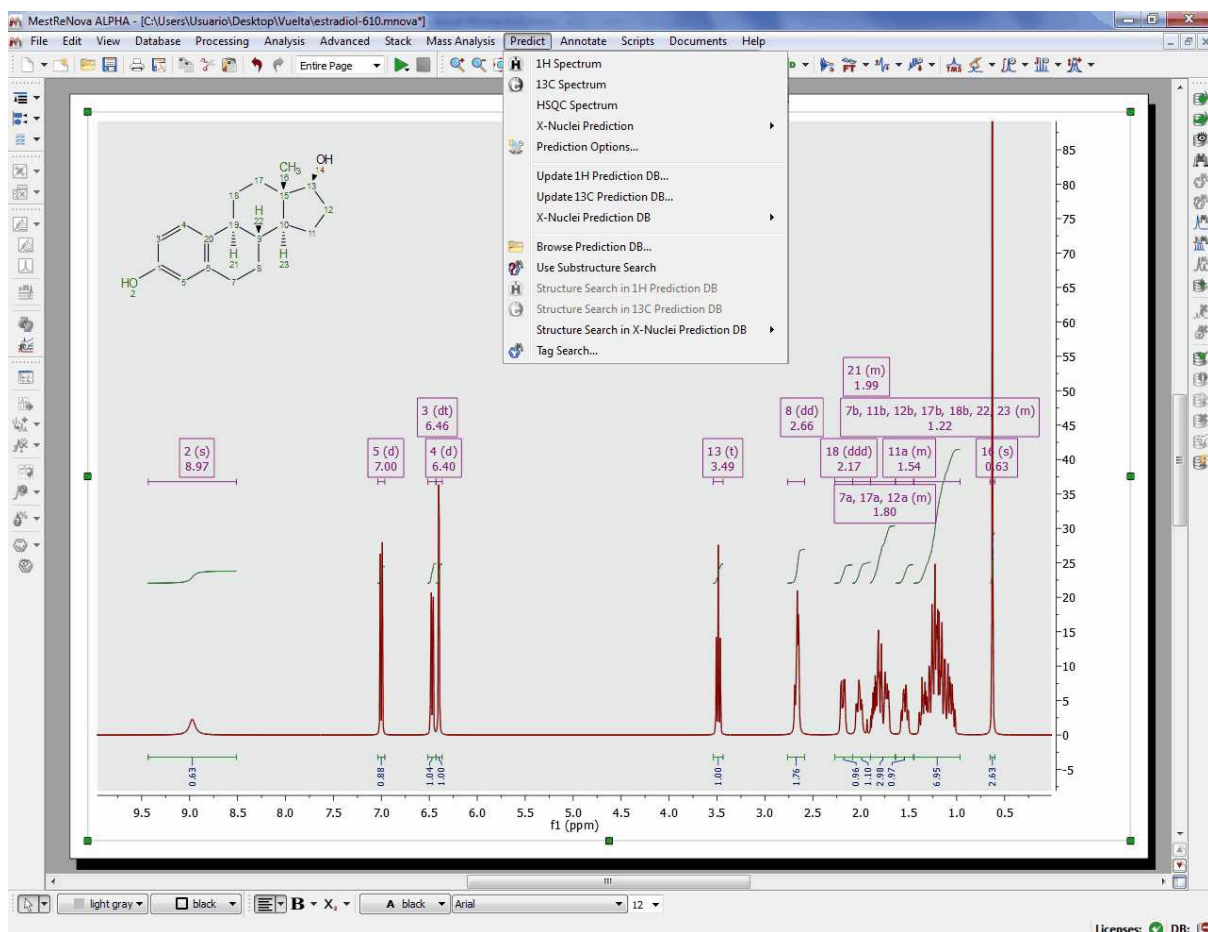

This will display a new dialog box, from where you will be able to see some information about the molecular structure and the assignments. From here it will be also possible to select the DB Letter in the Database where you want to save the assignments (from 'N' to 'Z'; the database letter chosen represents the unit which can be easily excluded from any subsequent prediction or search. Thus, the database letter should be carefully selected on an organization wide basis).

The screenshot shows a dialog box titled "Send To H DB". On the left, there is a chemical structure of a steroid molecule with a phenol group, a methyl group (CH₃), and a hydroxyl group (OH). Below the structure are two buttons: a plus sign (+) and a minus sign (-). Below these buttons is a table with two columns: "Tag" and "Value".

Tag	Value
1 DBLETTTER	N
2 SHIFTS	23

To the right of the structure is a table with two columns: "Atom" and "Shift".

Atom	Shift
1 2	8.972
2 3	6.47
3 4	6.398
4 5	7
5 7	1.185
6 7	1.725
7 8	2.675
8 8	2.675
9 11	1.2

At the bottom of the dialog box are two buttons: "OK" and "Cancel".

Here we can see the effect of having updated the prediction database. The blue spectrum corresponds with the original dataset, the green one with the original prediction (prior to the update of the Database) and the red one corresponds with the resulting predicted spectrum after having updated the database with the assigned experimental dataset. As you can see, now the prediction is even more accurate!

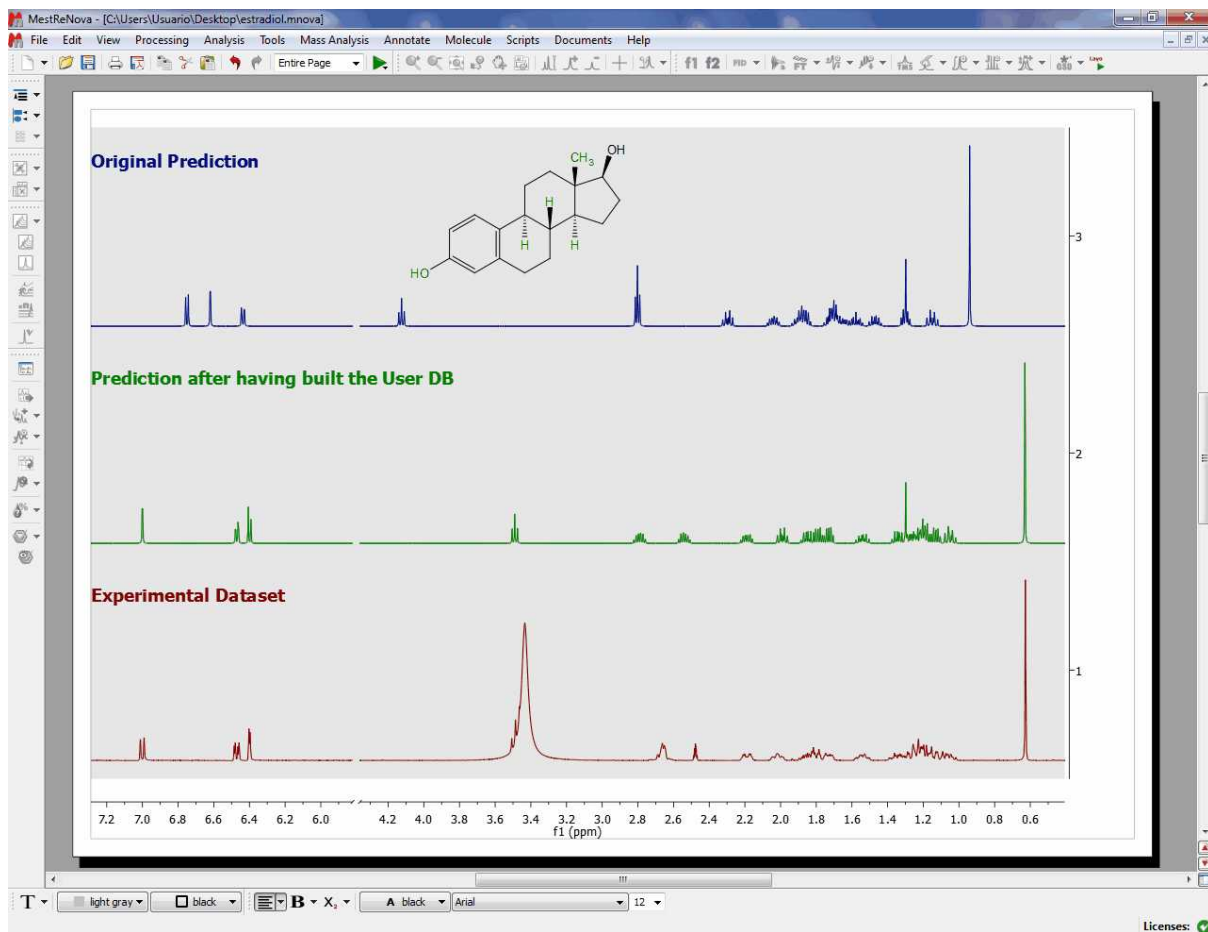

Once you have built your assignments database, it will be possible to search structures and substructures in the DB. To do that, just load a molecular structure with assignments and follow the 'Predict' menu':

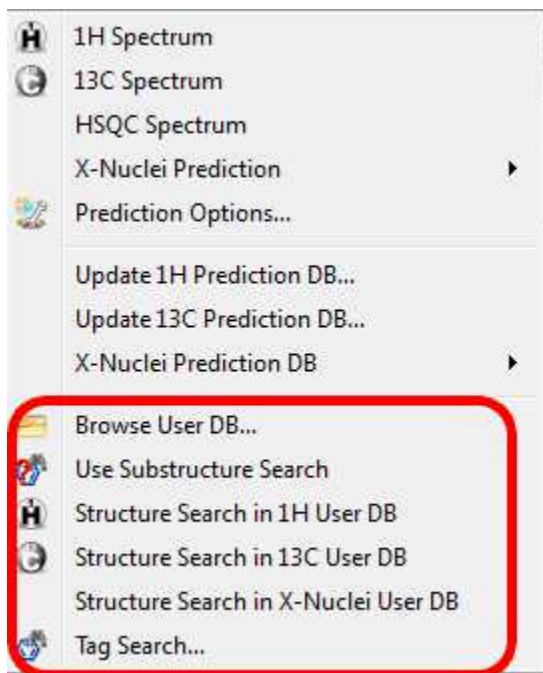

You can also Search for Tags:

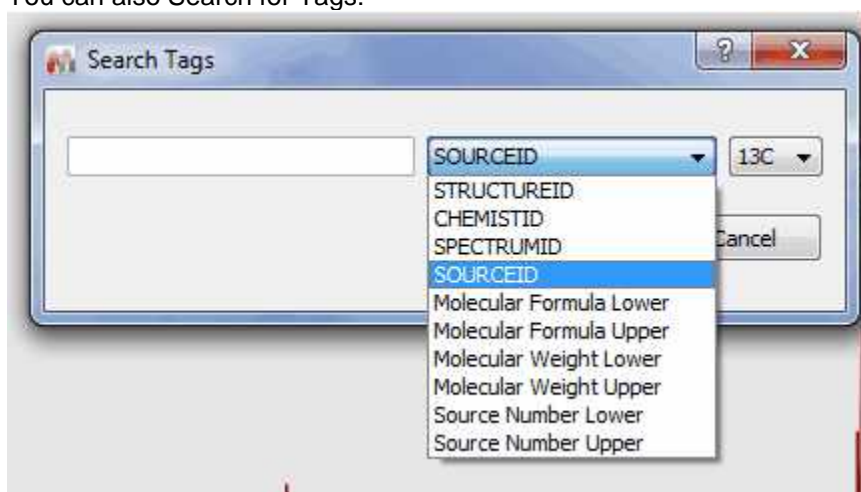

It will be possible to navigate through the database by using the DB Browser which can be accessed by following the menu 'Predict/Browse Prediction DB' or 'View/Panels/DBA Browser'.

DBA Browser

3 Structures Found in 1H database

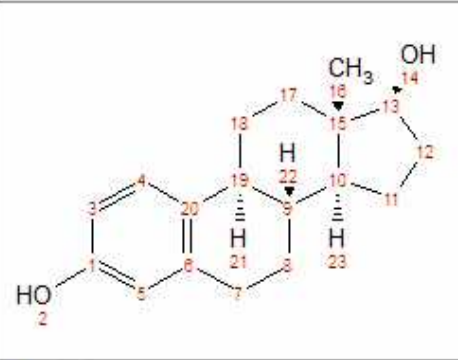

1



	Atom	Shift
1	2	8.972
2	3	6.47
3	4	6.398
4	5	7
5	7	1.725
6	7	1.185
7	8	2.675
8	8	2.675
9	11	1.539
10	11	1.2
11	12	1.85
12	12	1.34
13	13	3.487
14	14	
15	16	0.627
16	16	0.627
17	16	0.627
18	17	1.8

	Tag	Value
1	AUTHOR	
2	CHEMISTID	
3	COMPOUNDNAME	
4	DBLETTER	N
5	FREQUENCY	
6	LITERATURE	
7	SHIFTS	23
8	SOLVENT	chloroform
9	SPECTRUMID	
10	STRUCTUREID	
11	USERNAME	Usuario

From this browser, you will be able to navigate through the different compounds in the DB by using the 'blue arrows'. It will be also possible to paste the assigned molecular structure into Mnova, just by clicking on this button .

You will also be able to edit any assignment, just by double clicking on the cell and typing the new value. Once you have changed the value, click on this icon  to update the changes in the DB. If you want to remove any molecule from the DB, just click on this button .

It will be possible to select another DB just by clicking on this icon  which will display this dialog box to allow you to change the nucleus or the DB Letter (from 'N' to 'Z'):

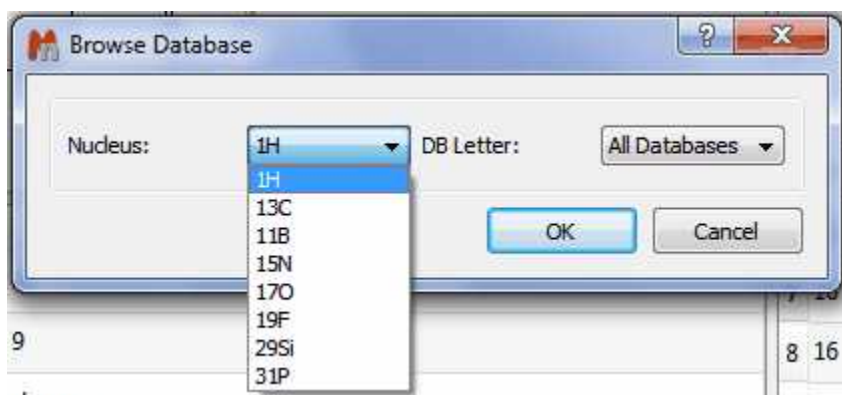

From the DBA browser you can also run substructures searches, just by clicking on the resulting icon for each nuclei:



The location of the prediction database can be selected from the 'Prediction Options' menu, after having clicked on the 'Predictor Properties' button.

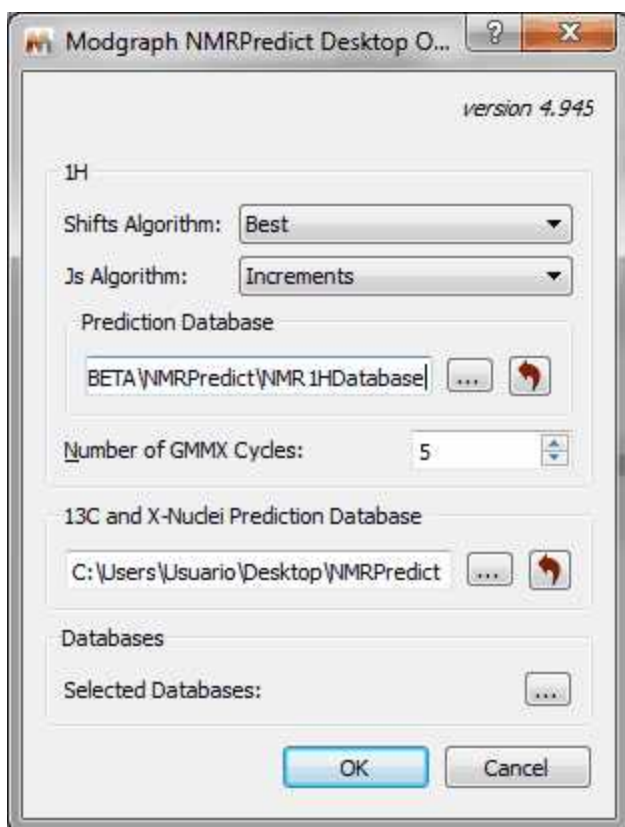

Please make sure that you have rights to write in the folders above (if not, you will need to change the

paths):

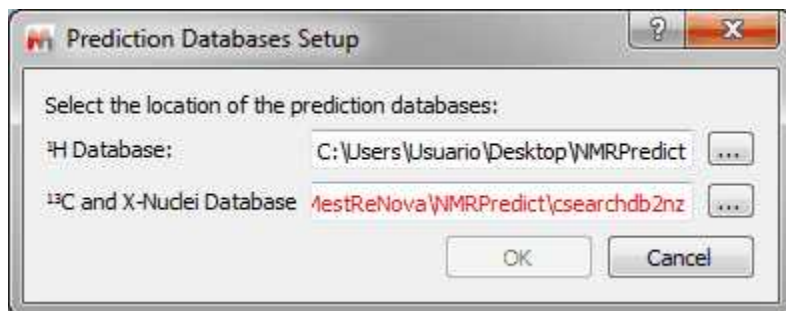

If you are getting a red path, please try to find the “*13C and X-nuclei folder*” called “**csearchdb2nz**” which should be here in W7 (or similar):

C:\Program Files (x86)\Mestrelab Research S.L\MestReNova\NMRPredict\

Then copy the “**csearchdb2nz**” folder to any other location where you have writing privileges (for example to your ‘My documents’ folder or directly to your ‘desktop’). Finally select the path in the ‘Prediction Databases Setup’ dialog box and try to update the prediction.

9.9.1.6 3D Molecule Viewer

You can activate the 3D molecule viewer after having running a prediction which involves more than one conformer. In that case, just highlight the molecular structure and follow the menu 'View/Panels/3D Molecular Viewer':

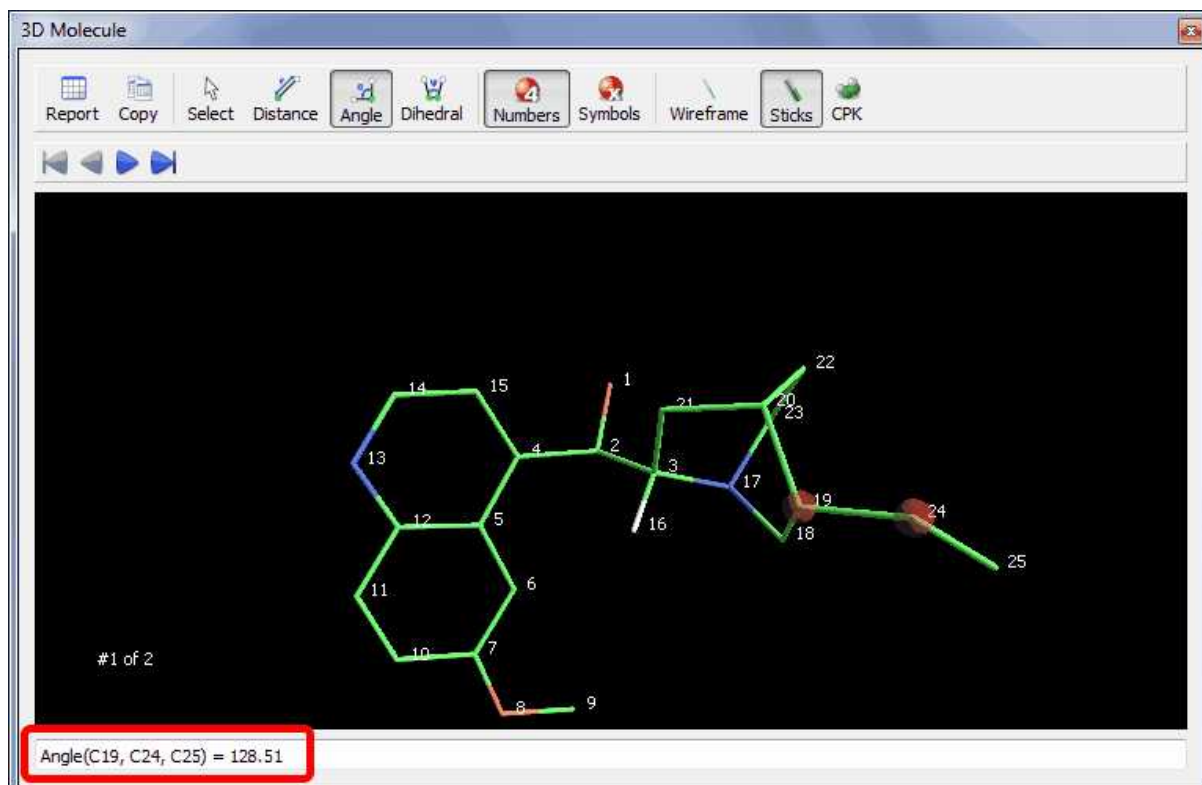

You will be able to navigate through the set of conformers by using the ‘Navigator toolbar’



Molecular 3D structures can be managed by:

- Clicking on the right mouse button and dragging (or scrolling up or down the mouse wheel) to zoom in/out the molecule structure.
- Clicking on the left mouse button and dragging to apply a *TrackBall Rotation* (the user is able to control the movement of a ball which contains the molecule).

From this panel, the user will also be able to select the rendering mode (Wireframe, Sticks and Ball Sticks).

The user will be able to measure the bond distance, the angles and the dihedrals by just clicking on

the corresponding buttons of the toolbar



and next selecting the desired atoms to analyze. As you can see in the screenshot above, we have measured the angle between the atoms C19-C24-C25.

9.9.1.7 Prediction Options

Following the menu Predict/Prediction Option will display a dialog box from where you will be able to select the chemical shift limits of the spectral window, as well as other parameters, such as number of points, frequency, Line Width, solvent and minimum coupling constant value. If you are going to predict a ¹H-NMR spectrum, you can also exclude the 'Labile Protons' from this window

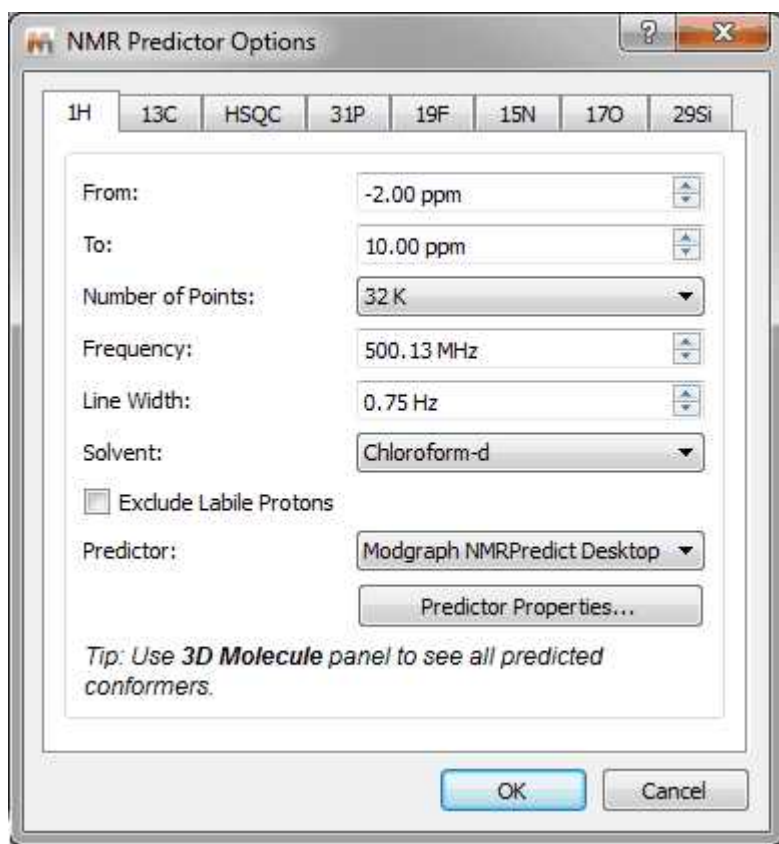

Clicking on the 'Predictor Properties' button will display a dialog box to allow you to select the location of the prediction [Databases](#) and also the algorithms to use (Best, Increments or Conformers) for the

shifts and Js in the 1H prediction:

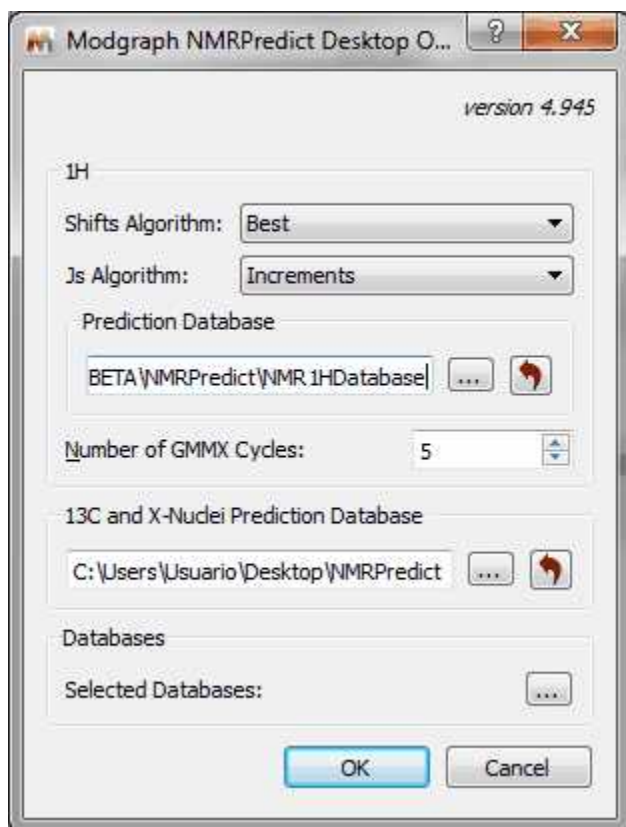

Clicking on the 'Selected Database' will allow you to select the 'Prediction Databases' that you want to use for your predictions:

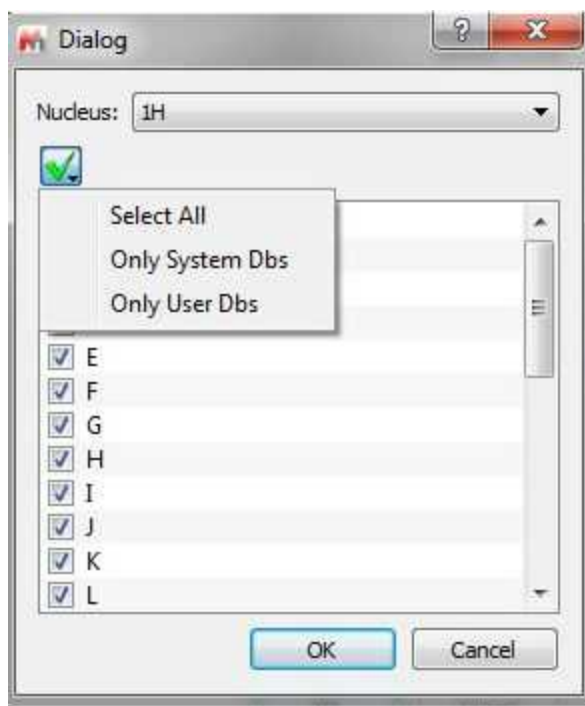

9.9.2 NMRPredict Server-Based

NMR Prediction: The handling of molecular structures within Mnova also allows the user to carry out **spectral predictions**. Although the process described here could be applied to predictions by means of any commercially available or in-house prediction package, currently Mnova will carry out predictions by using the prediction application **NMRPredict**, by Modgraph Consultants Ltd. Please note that this is a separate plugin which must be licensed in addition to Mnova.



A few notes on NMR Prediction Server-based

- ✓ As opposed to **NMRPredict Desktop**, **NMRPredict server-based** is a **client-server** application, so to carry out the predictions you will have to log in to the server via a dialog box shown by Mnova. Log in details will be provided to you when downloading **NMRPredict**. This login will only have to be carried out the first time you run a prediction with Mnova. After that, the software should remember your login details and do the log in in the background.
- ✓ Because it is a client-server application and the data are being sent over the internet to the server, industrial testers may wish to have an in-house installation of NMRPredict for security reasons. If this is the case, just write to us with your request at nmrpredict@mestrelab.com.
- ✓ Customers who have their own in-house prediction package are welcome to contact us to discuss a similar, seamless integration of their own prediction package. Please write to us at support@mestrelab.com.
- ✓ Please note that NMRPredict is a different software package to Mnova and therefore, in order to carry out predictions via this package, a license of NMRPredict must be held separately, once the NMRPredict evaluation has expired.

Carrying out of predictions in Mnova is very simple. With a molecular structure open in the active page of Mnova, just go to the 'Predict' menu and select Prediction Options; then a dialog box will open.

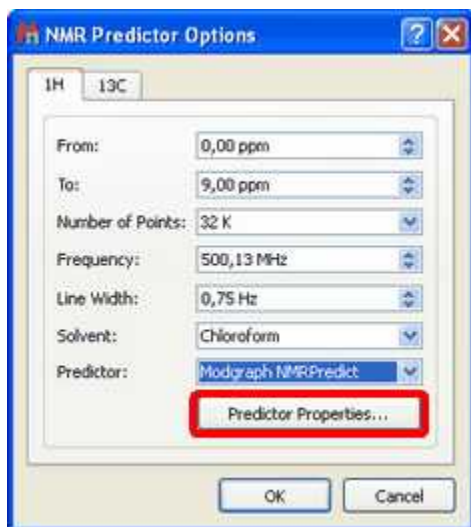

This open dialog allows the user to set a series of prediction parameters before carrying out the prediction: limits, number of points, frequency of the spectrometer, line width, solvent and the Predictor methodology. To carry out a server-based NMR prediction the user has to select 'Modgraph NMRPredict Server' in the 'Predictor' edit box.

Clicking on the 'Predictor Properties' (red square in the capture above), the user will be able to select the algorithm for the ^1H -NMR prediction (Increment or Charge):

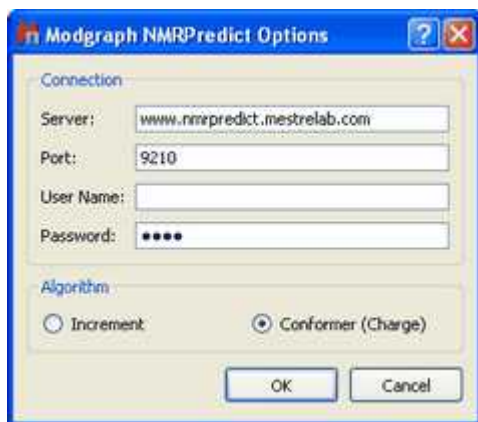

The Increment algorithm (based in Ernő Pretsch's NMR tables) is the same as NMRPredict Desktop uses to predict NMR spectra

The CHARGE program offers ^1H -NMR prediction based upon partial atomic charges and steric interactions. This program offers the **first** quantitative prediction of the proton chemical shifts of a variety of organic compounds.

The program works by first generating 3D conformers from a 2D structure through a choice of *force fields* and then predicting proton spectra for all the conformers. The program works by looking at functional groups which have parametrised by Professor Abraham.

To read more about the CHARGE theory, please visit the following link:

http://www.modgraph.co.uk/product_nmr_proton.htm



Please remember that:

NMRPredict is a **client-server** application, so to carry out the predictions you will have to log in to the server via a dialog box shown by Mnova. Log in details will be provided to you when downloading **NMRPredict**. This login will only have to be carried out the first time you run a prediction with Mnova. After that, the software should remember your login details and do the log in in the background.

Finally, just go to the 'Predict' menu and select 'Predict 1H Spectrum' or 'Predict 13C Spectrum'.

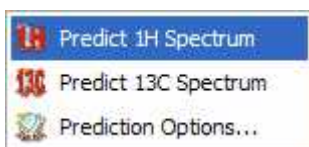

This will send a request to the server, which will run a prediction and return a set of values which Mnova will display as a spectrum on the screen. You will immediately notice that this will be an assigned spectrum, and therefore hovering of the mouse over the atoms will highlight the applicable peak on the spectrum and viceversa.

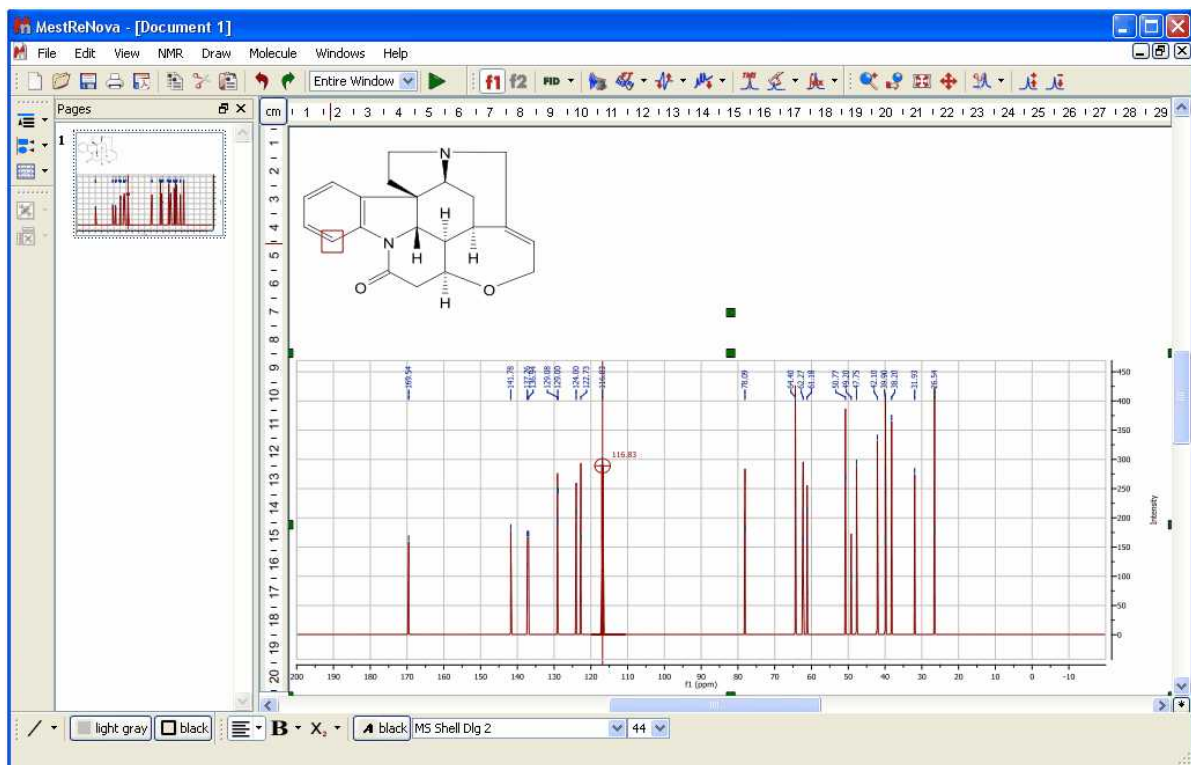



A few notes on the synthetization of NMR 1H spectra

- ✓ It is important to note that the simulation carried out by Mnova when displaying the predicted values as a spectrum **is not first order**. The software is carrying out the **full quantum-mechanics calculations** to arrive at the displayed spectrum. This is very computationally intensive and results in such simulation module having a limitation, for 1H spectra, which prevents it from simulating spin systems larger than 13 spins. However, we have developed a new algorithm to overcome this problem.

The prediction of the ¹³C-NMR is based on the HOSE code approach. The **HOSE** (Hierarchical Organisation of Spherical Environments) code approach starts at the carbon atom whose shift is to be predicted, looks one bond away from the carbon and tries to find this same environment in its database. If it is successful it moves two bonds away and tries again and so on until it either comes across something not represented in the database or it reaches the boundary of the molecule.

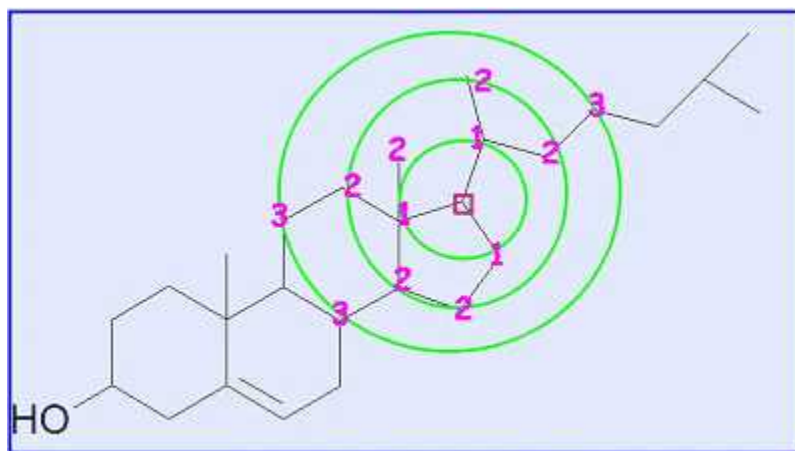

The HOSE code approach works very well for query structures which are well represented in the reference collection. If atoms can be predicted to three spheres or more (NMRPredict goes to a maximum of five spheres) the prediction can be considered to be very reliable.

However, if the query structure is not well represented in the database and the atom can only be predicted to one or two spheres the prediction cannot be relied upon at all. Also the HOSE code approach exactly reproduces the contents of the reference database – including every error within the reference database.

If atoms can only be predicted to one or two spheres the only solution traditionally was to add your own similar data and use that for prediction. This is now possible with NMRPredict by using NMRPredict DBA. However, NMRPredict also uses a unique Neural Network algorithm, which is much more general and error tolerant than the HOSE code approach and is much more accurate at predicting atoms it has not seen in its database.

9.10 Tables

Mnova groups all spectra relevant information into the so-called **Tables window**, available from the **View** menu or by right clicking on any toolbar.

	Range	Normalized	Absolute
1	7.85 .. 7.72	1.00	43685.19
2	6.73 .. 6.56	1.03	45026.66
3	5.91 .. 5.84	1.02	44492.10
4	4.30 .. 4.24	1.03	44850.78
5	4.17 .. 4.09	1.04	45349.12
6	4.08 .. 4.01	1.05	45707.23
7	3.92 .. 3.87	3.11	135900.60
8	3.87 .. 3.83	4.12	180070.53
9	3.83 .. 3.78	1.22	53170.47
10	3.72 .. 3.64	1.13	49431.41
11	3.20 .. 3.01	3.22	140585.40
12	2.88 .. 2.77	1.07	46792.28
13	2.74 .. 2.67	1.05	45756.58
14	2.67 .. 2.60	1.10	48210.60
15	2.38 .. 2.29	1.06	46387.96
16	2.01 .. 1.92	0.90	39331.89
17	1.92 .. 1.77	2.26	98611.68
18	1.49 .. 1.41	1.06	46151.39
19	1.29 .. 1.19	1.25	54462.08

From this set of tabbed pages, the user can find information, about:

- Elemental Composition (Mass plugin)
- Molecule Match (Mass Plugin)
- Mass Peaks (Mass plugin)
- Compounds
- GSD Peaks
- Arrayed Data (DOSY, T1/T2, etc... processing)
- Assignments
- Integrals
- Multiplets
- Parameters
- Peaks
- ¹H Prediction (Prediction plugin)
- ¹³C Prediction (Prediction plugin)
- X-Nuclei Prediction (Prediction plugin)

Spectral Parameters: This table shows information about:

- Experiment Title
- Data File Name
- Origin of the Experiment (type of spectrometer used)
- The Owner
- Solvent Used (CDCl₃ in the example below)
- The Frequency of the Spectrometer Used to Carry Out the Experiment

- Number of Acquired Data Points
- Spectral Width
- Spectrum Size After FT
- Lowest Frequency (in Hz) Used for Referencing Purposes, etc.

Please note that Mnova includes the ability to add more parameters into this list and customize the way it is displayed on the screen. See also: [Parameters Table](#)

The user can directly paste the spectral parameters table on the spectrum by clicking on the 'Report' icon (red square in the capture below). You can also export the table to another document by clicking on the 'Copy to Clipboard' icon  (green square in the screenshot below).

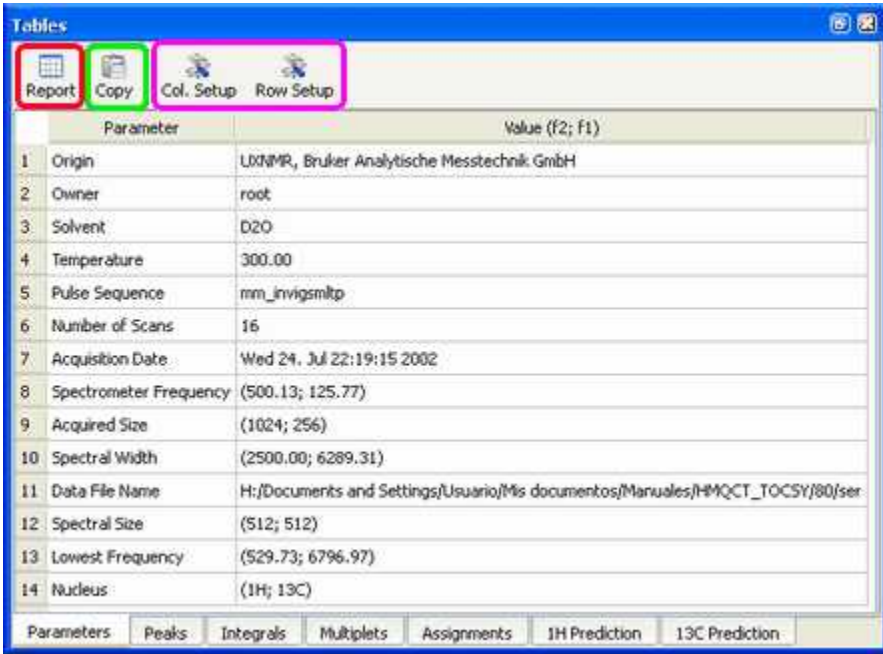

	Parameter	Value (F2; F1)
1	Origin	LUXNMR, Bruker Analytische Messtechnik GmbH
2	Owner	root
3	Solvent	D2O
4	Temperature	300.00
5	Pulse Sequence	mm_invigsm1tp
6	Number of Scans	16
7	Acquisition Date	Wed 24. Jul 22:19:15 2002
8	Spectrometer Frequency	(500.13; 125.77)
9	Acquired Size	(1024; 256)
10	Spectral Width	(2500.00; 6289.31)
11	Data File Name	H:/Documents and Settings/Usuario/Mis documentos/Manuales/HMQCT_TOCSY/80/ser
12	Spectral Size	(512; 512)
13	Lowest Frequency	(529.73; 6796.97)
14	Nucleus	(1H; 13C)

The user will be able to modify some of the parameters (Spectrometer frequency, Spectral Width, Lowest Frequency, Nucleus...) by just double clicking on the value as is shown in the picture below:

	Parameter	Value (f2, f1)
1	Data File Name	H:/Documents and Settings/Usuario/Escritorio/js1pmftalato/js1
2	Title	js1pmftalato
3	Origin	inova
4	Owner	
5	Solvent	CDCl3
6	Temperature	25.00
7	Pulse Sequence	gh5QC
8	Number of Scans	16
9	Acquisition Date	20071020T003052
10	Spectrometer Frequency	(399.97, 100.57)
11	Spectral Width	(3668.04, 25000.00)
12	Lowest Frequency	(-233.13, -1917.94)
13	Nucleus	f1: 1H f2: 13C
14	Spectral Size	f1: 1H
15	Acquired Size	13C

You can customize the table, by clicking on the **'Column or Row Setup'** icon . The 'Customize Table' dialog box will be displayed and will allow you to change the name of the columns, hide them, change the number of decimals as well as the horizontal alignment.



Once any table has been reported, it is possible to change its properties (position, size, fill and border) just by double clicking on it:

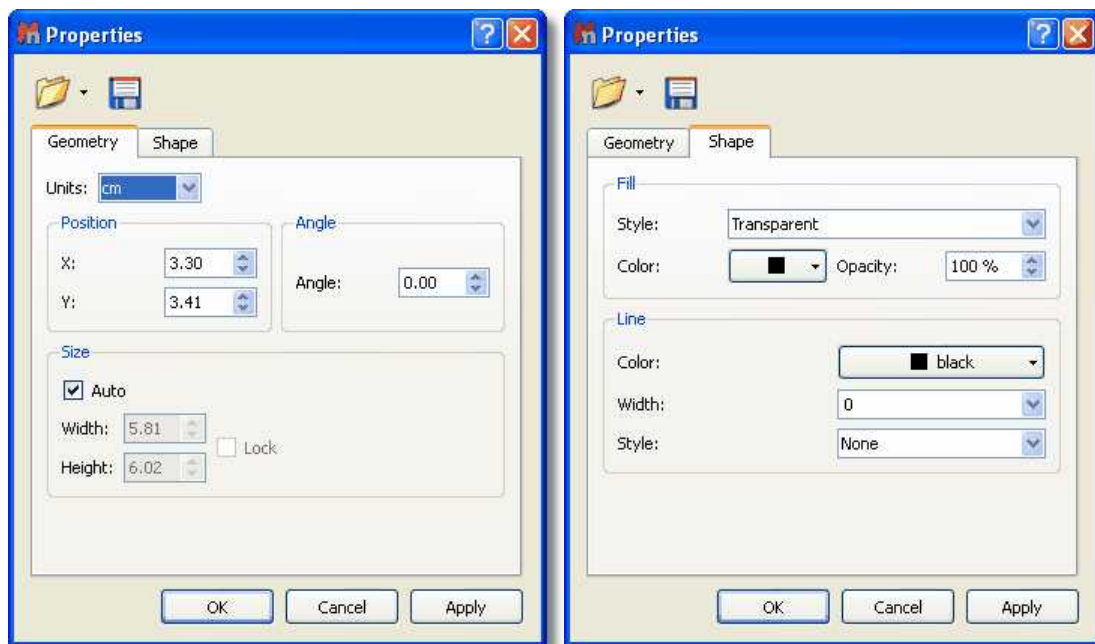

See also:
[Parameters Table](#)

Peak Table: By default, peak frequencies are listed directly on the spectrum but they can also be accessed via the *Peak Picking table* by following the menu 'View/Tables/Peaks'.

Peaks

Report Peaks Copy Peaks Setup Report Delete Select Peaks

Sync From Spec Filter Sync To Spec Set Flags Set Compound New Spectrum

	ppm	Hz	Intensity	Width	Area	Type	Flags
1	8.85	3539.1	29.2	1.32	294.19	Compound	Weak + C13_Sat
2	8.84	3534.6	29.3	1.22	270.32	Compound	Weak + C13_Sat
3	8.78	3512.9	21.9	0.92	153.96	Impurity	Weak
4	8.77	3508.4	23.6	0.85	162.98	Impurity	Weak
5	8.64	3456.9	40.6	1.42	500.00	Compound	Weak
6	8.64	3455.5	28.4	0.19	48.33	Compound	Weak
7	8.64	3454.5	37.3	3.14	955.56	Compound	Weak
8	8.63	3451.0	6203.9	1.00	46415.96	Compound	None
9	8.62	3446.6	6622.7	0.82	44958.30	Compound	None
10	8.60	3440.5	27.3	0.91	147.13	Compound	Weak
11	8.52	3406.5	7.0	0.86	46.67	Impurity	Weak
12	8.40	3361.2	26.8	1.32	252.49	Compound	Weak + C13_Sat

This table displays the list of peaks, including the following information: chemical shift in ppm and Hz, intensity (height), width (width, in Hz, at half maximum of the peak), type (the user can select between 'Compound', 'Artifact', 'Impurity' or 'Solvent') and 'Annotations'.

The user can report the Peak table directly on the spectrum by clicking on the **'Report Table'** icon  (under the Report Text scroll down menu) It is also possible to customize the appearance of this

report (an also of the table), by clicking on the **'Setup Table'** button  (under the Setup Text scroll down menu) to display the 'Customize Table-Peaks' dialog box:

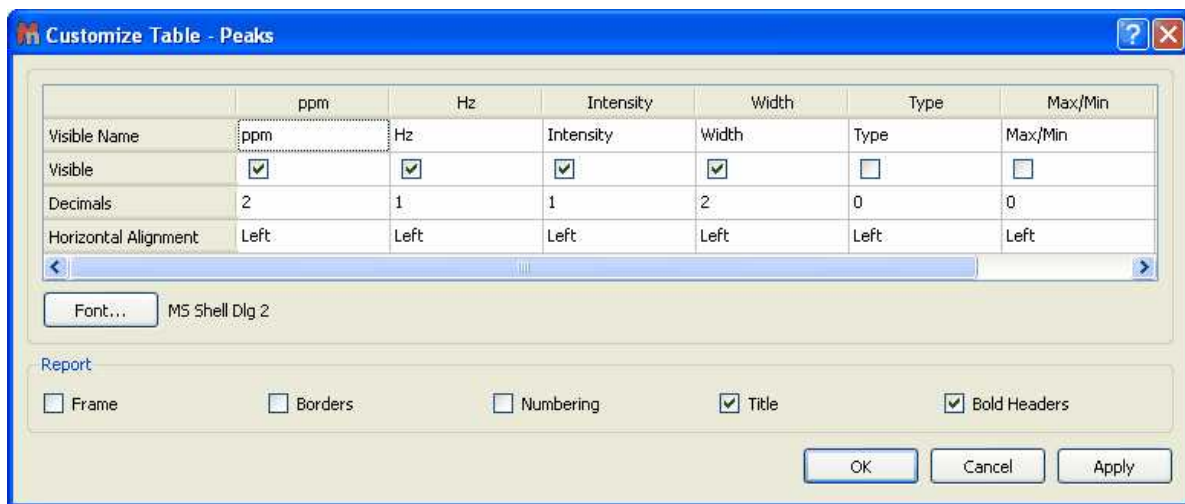

This dialog box will allow the user to change the name of the columns, hide them, change the number of decimals as well as the horizontal alignment. It is also possible to change the Font Family and also to customize the appearance of the table report (Frame, Borders, Numbering, Title and Bold Headers).

The user will also be able to select the multiplicity of the carbon signals, just by double clicking in the applicable cell, as you can see in the picture below:

	ppm	Hz	Intensity	Width	Multiplicity
1	164.59	20700.3	14829.9	3.63	C
2	164.51	20691.3	15192.3	3.46	C
3	150.55	18935.1	17656.2	3.74	C
4	150.44	18920.5	58586.9	3.49	CH
5	138.03	17360.2	58763.0	3.36	CH
6	128.32	16138.7	18100.4	3.51	C
7	124.40	15646.3	60696.7	3.41	CH
8	52.91	6654.4	55386.2	3.30	CH3
9	52.48	6600.8	55978.5	3.29	CH3

Para... Inte... Multi... Assi...

light gra black

Unknown
C
CH
CH2
CH3

To delete an undesired peak, click on the **'Delete'** icon  of the Peak List, or select 'Delete Manually' on the Peak Picking scroll bar icon

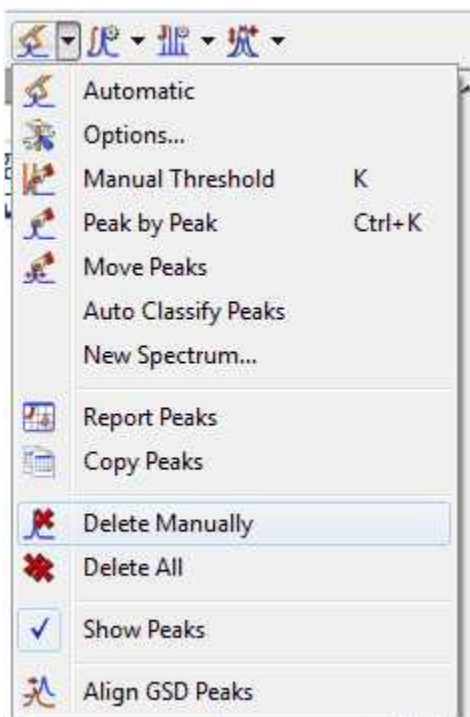

By default, peak frequencies are listed directly on the spectrum but they can also be accessed via the

Peak Picking table and also as a **'Peak List'** by clicking on the **'Report Text'** icon . The user will be able to select the 'Peak Report Template' between several journal formats by selecting 'Setup Text' in the 'Report Special' scroll down menu.

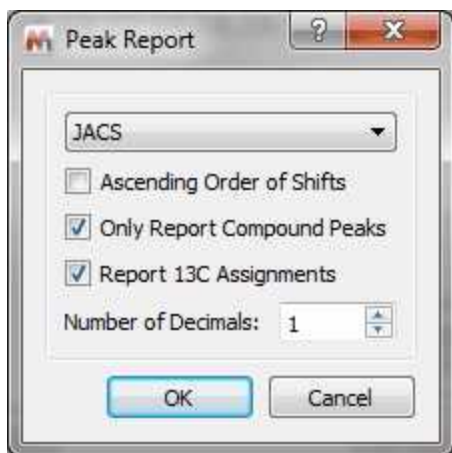

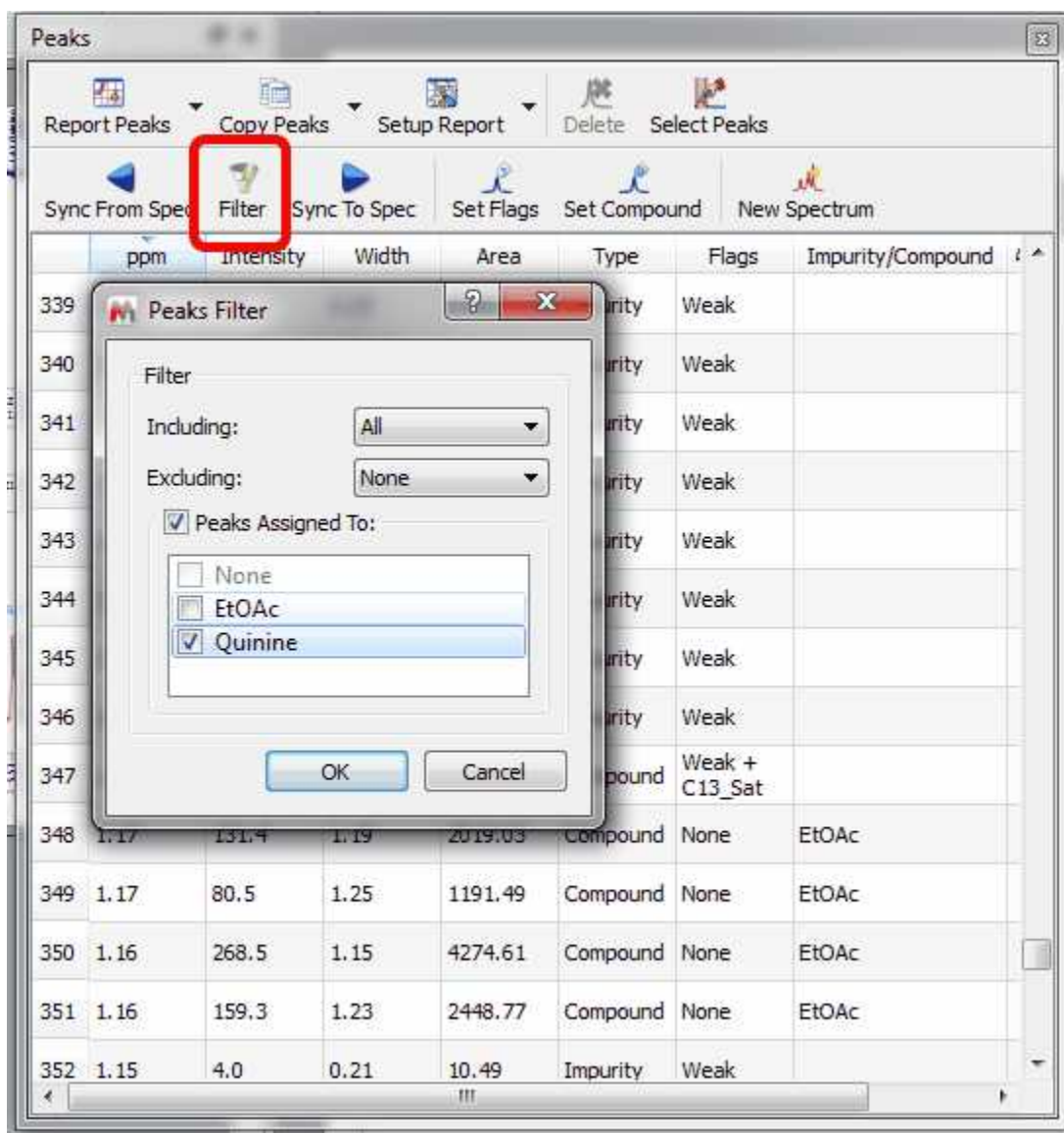

From here you can select the order of the report or only report the compounds peaks.

From the Peaks table it will be possible to apply some filter (by clicking on the applicable button) to show for example only Compounds Peaks:



It will be also possible to synchronize the type of the peaks in the table (i.e: only Compounds peaks) with the peaks showed in the spectrum (by using the button 'Sync from Item') or viceversa, to synchronize the spectrum peaks with the peaks showed in the table ('Sync to Item' button).

Integral List: The Integrals Table includes information about the integral range (in ppm) and the normalized and absolute values of each integral. In this table the user can normalize the integrals by double clicking on the normalized value of the integral which the user would like to set (in the red square on the capture below). Once it is highlighted, the user has to overwrite the desired value, press return, and all integrals will update with reference to the chosen one. You will obtain the same effect by double clicking directly on the integral label on the spectrum.

The user can also delete an integral from this table by clicking on the 'Delete' icon  when the undesired integral is highlighted. To paste the integral list on the spectrum, just click on the 'Report' icon .

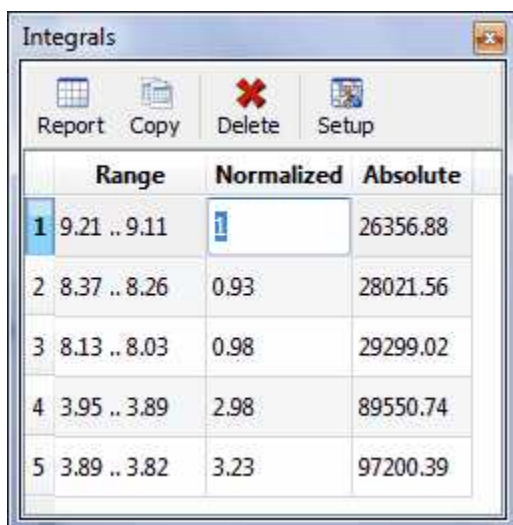

	Range	Normalized	Absolute
1	9.21 .. 9.11	1	26356.88
2	8.37 .. 8.26	0.93	28021.56
3	8.13 .. 8.03	0.98	29299.02
4	3.95 .. 3.89	2.98	89550.74
5	3.89 .. 3.82	3.23	97200.39

Multiplets: The multiplet table includes information about the name (by default Mnova named the multiplets following the alphabetical order, but the user is able to change it in the multiplet manager), the chemical shift (ppm), the range (ppm), number of hydrogens, integral value, type of multiplet and coupling constant values (Hz).

Multiplets



Report Multiplets Copy Multiplets Setup Report Delete

¹H NMR (400 MHz, CDCl₃) δ 8.62 (d, *J* = 4.4 Hz, 1H), 7.95 (d, *J* = 9.4 Hz, 1H), 7.46 (d, *J* = 4.5 Hz, 1H), 7.30 (dd, *J* = 9.3, 2.7 Hz, 1H), 7.21 (d, *J* = 2.7 Hz, 1H), 5.73 (ddd, *J* = 17.5, 10.3, 7.6 Hz, 1H), 5.48 (d, *J* = 4.3 Hz, 1H), 4.99 – 4.84 (m, 2H), 3.87 (s, 3H), 3.38 (dddd, *J* = 13.4, 10.5, 5.6, 2.5 Hz, 2H), 3.17 – 2.99 (m, 2H), 2.63 (dddt, *J* = 10.7, 6.0, 4.3, 2.0 Hz, 2H), 2.30 – 2.18 (m, 1H), 1.83 – 1.62 (m, 3H), 1.61 – 1.34 (m, 2H).

	Name	Shift	Range	H's	Integral	Absolute	Class	J's
1	C (d)	7.46	7.51 .. 7.43	1	0.86	92585.19	d	4.51
2	A (d)	8.62	8.67 .. 8.58	1	0.80	86101.39	d	4.39
3	N (m)	1.71	1.83 .. 1.62	3	3.29	352791.56	m	
4	M (m)	2.24	2.30 .. 2.18	1	0.96	103210.06	m	
5	L (dddt)	2.63	2.69 .. 2.55	2	1.97	211502.68	dddt	2.01, 2.01, 4.29, 6.03, 10.73
6	K (m)	3.09	3.17 .. 2.99	2	2.31	247987.14	m	
7	J (dddd)	3.38	3.46 .. 3.31	2	1.90	203318.84	dddd	2.54, 5.56, 10.50, 13.36
8	I (s)	3.87	3.90 .. 3.85	3	3.08	330582.25	s	

See also ['Multiplets Table](#).

¹H Prediction: In this table, the user can visualize the ¹H assignments of the predicted shifts (in NMR Predict mode). As you can see in the picture below, the carbon atoms are labeled to make easy the proton assignment. The user can also select the frequency of the desired predicted spectrum (on the frequency edit box) as well as do (or not) groups magnetically equivalents (by clicking on the

suitable icons: ) and also expand or collapse the predicted values by clicking on the applicable buttons 

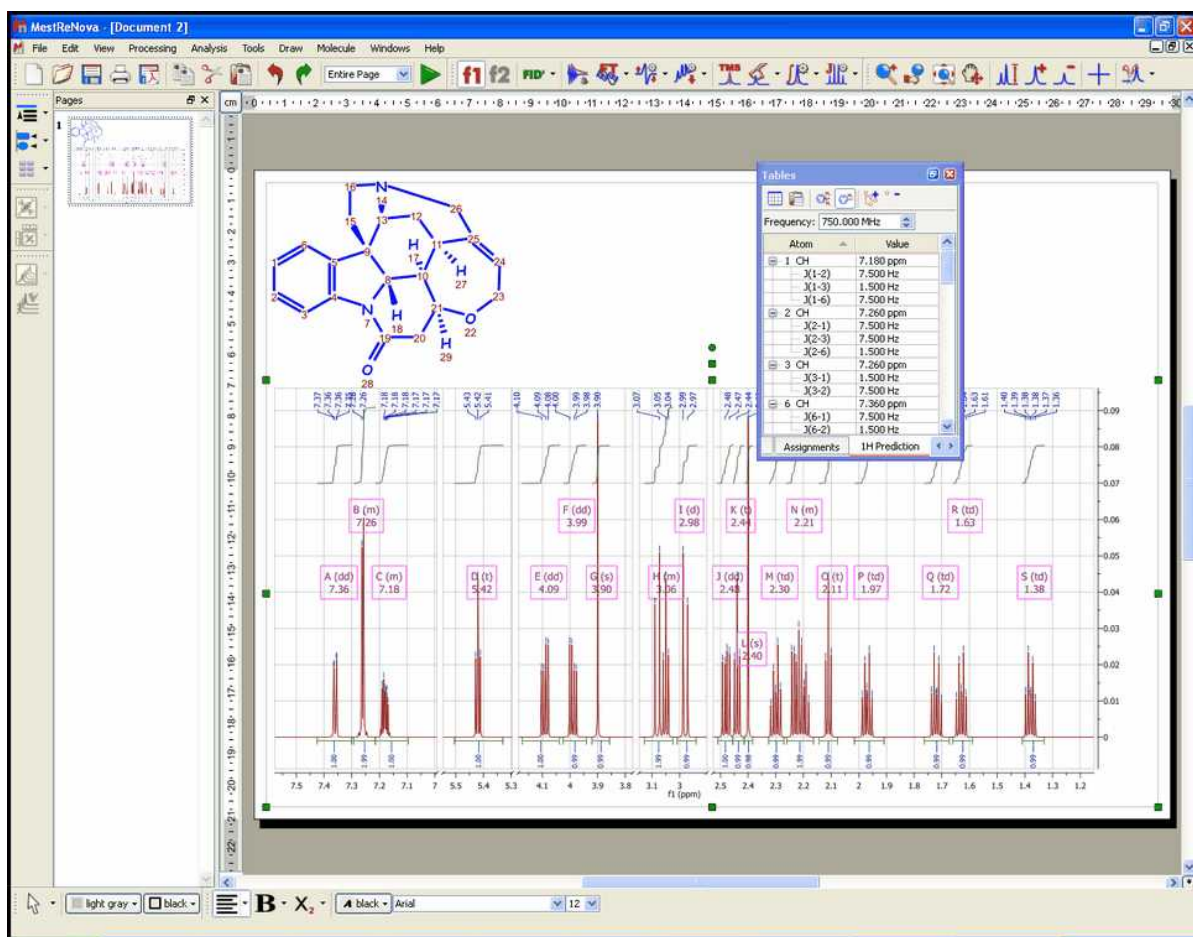

You can also modify the chemical shift and coupling constant values directly from this tables, just by double clicking on the applicable box and entering the desired value.



The screenshot shows the 'Tables' window for a 300.000 MHz frequency. The table is as follows:

Atom	Value
1a CH2	3.960 ppm
J(1a-1b)	-12.400 Hz
J(1a-6)	7 Hz
1b CH2	3.710 ppm
J(1b-1a)	-12.4 Hz
J(1b-6)	7 Hz
3 CH	4.500 ppm
J(3-4)	7.000 Hz
J(3-21)	7.000 Hz
4 CH	4.65 ppm
J(4-3)	7.000 Hz
J(4-5)	7.000 Hz
5 CH	5.250 ppm
J(5-4)	7.000 Hz
J(5-6)	7.000 Hz
6 CH	4.660 ppm

Please bear in mind that you can also put the table on the 'Page Navigator' just by clicking on the table

and dragging it to the 'Page Navigator', as you can see in the picture below:

	ppm	Hz	Intensity	Width	Type	Annotation
5	141.93	14275.41	194.0	3.77	Compound	
6	131.59	13235.55	177.8	4.39	Compound	
7	126.65	12738.65	93.0	4.31	Compound	
8	121.49	12219.60	174.0	4.60	Compound	
9	118.39	11907.57	187.3	4.26	Compound	
10	114.30	11496.19	195.2	4.62	Compound	
11	101.31	10189.51	186.2	4.71	Compound	
12	77.32	7776.84	4410.5	5.05	Solvent	
13	77.00	7744.89	4496.6	5.04	Solvent	CDCl3
14	76.68	7712.95	4450.2	5.09	Solvent	
15	72.27	7269.40	198.9	4.58	Compound	

¹³C Prediction: In this table, the user can visualize the ¹³C assignments of the predicted shifts (in NMR Predict mode). You can also select the frequency of the desired predicted spectrum (on the frequency edit box). The user can paste the ¹³C Prediction table directly on the spectrum by clicking on the 'Report' icon  or copy it to the clipboard by clicking on the applicable icon . You can also customize this table by clicking on .

Atom	Value
1 C	144.91 ppm
2 C	147.95 ppm
3 CH	101.52 ppm
4 C	142.32 ppm
5 C	124.140 ppm
6 CH	110.00 ppm
8 C	170.12 ppm
9 CH2	38.16 ppm
10 CH	78.08 ppm
12 CH2	64.08 ppm
13 CH	126.59 ppm
14 C	138.68 ppm
15 CH2	54.58 ppm
16 CH	31.36 ppm
17 CH	49.89 ppm
19 CH2	27.40 ppm

1H Prediction 13C Prediction

Compounds: This table will show all the molecules present in the document, with information about the chemical formula and molecular weight, name.

Molecule	Molecular Formula	Average Mass	isotopic	Name	Label	Description	Color
	C ₄ H ₈ O ₂	88.11	88.05	Ethyl Acetate	Ethyl Acetate	Impurity: residual solvent	Orangered
	C ₂₀ H ₂₄ N ₂ O ₂	324.42	324.18	Quinine	Quinine	Main compound	Dodgerblue

You can copy any molecule from this table to another page just by selecting it and clicking on the 'Report' button. Please bear in mind that the information about predictions and assignments is linked to the molecule and will be kept after having pasted it to another slide.

You will be able to dock any table to the right or left side of the spectrum just by clicking on it and dragging to the desired place:

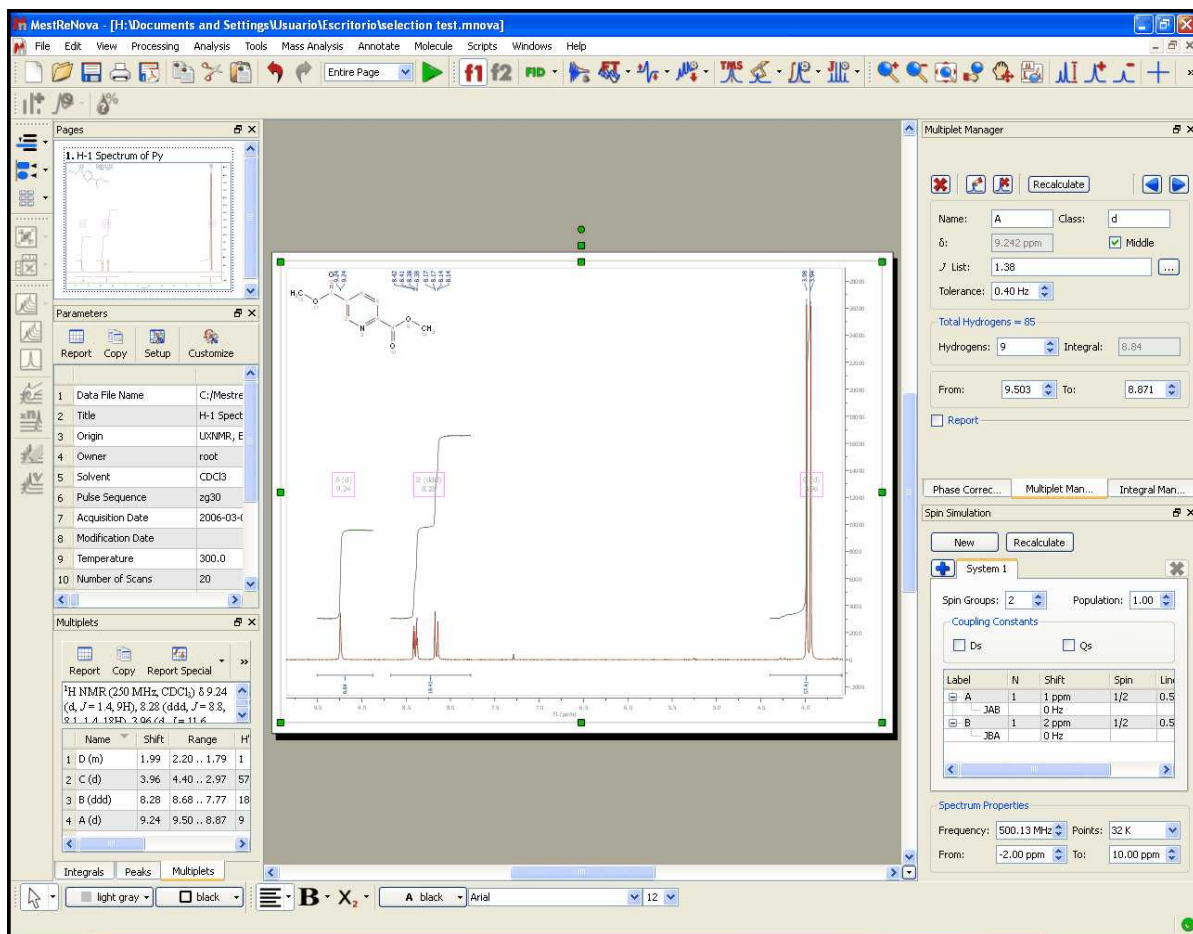

Part



10 Advanced Menu

You will find under this menu some advanced tools for the more expert users, such as GSD, Line Fitting, Data Analysis, DOSY transform, Arithmetics, Verification, qNMR etc...

10.1 Line Fitting (Deconvolution)

When the spectrum is crowded with peaks, or affected by excessive noise, deconvolution may be the only way to measure the compounds ratio; but please bear in mind that this feature does not make miracles and it can not be a substitute for higher magnetic fields, more concentrated samples or longer acquisitions.

The name “deconvolution” means (more or less): “removing the shape”. The theoretical shape of an NMR peak is given by the Lorentzian equation. Field inhomogeneity and weighting functions can however yield partial Gaussian line-shapes. From a merely graphical (and practical) point of view, they are two complementary shapes, in the sense that most symmetrical peaks can be approximated with suitable combinations of Lorentzian and Gaussian components. For your convenience, Mnova defines a mixed function, for which you can vary at will the percentages of Lorentzian and Gaussian character.

MestReNova includes a fully interactive interface for the deconvolution of experimental spectra into individual lines.

This module includes options for locking any of the parameters during optimization and the ability to compare the resulting calculated spectrum, as a sum of the individual components, with the experimental spectrum.

It is really easy to run the Line Fitting feature. Just click on the 'New Fit Region' icon  (or follow the menu 'Advanced/Line Fitting/New Fit Region') and next click and drag over the desired region of the spectrum. (Please make sure that you have corrected the baseline of the experiment)

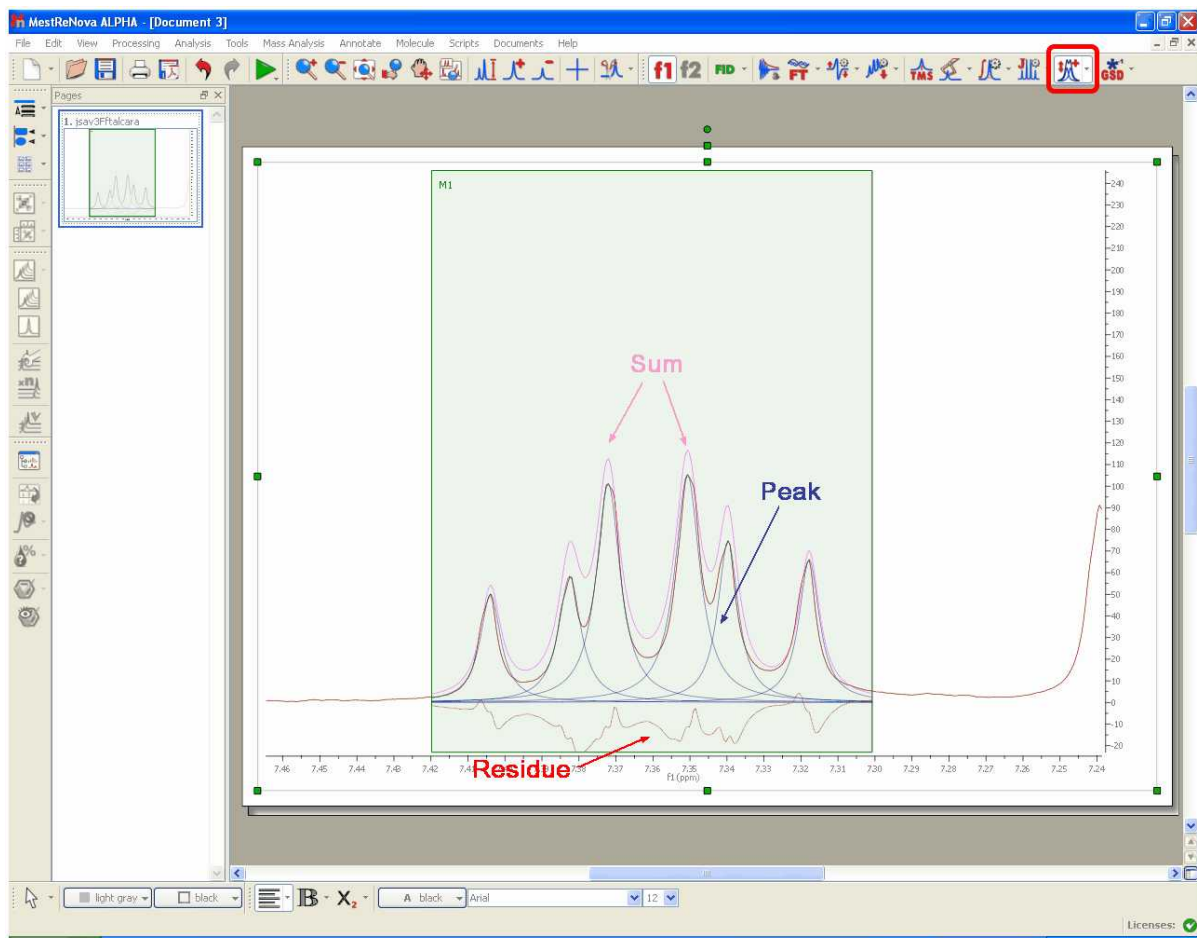

You can see in the picture above a blue line which corresponds with the fit peak, a red line which corresponds which the fitting residue and a magenta line which corresponds with the sum.

Next, select Fit under the scroll down menu to carry out the Fitting:

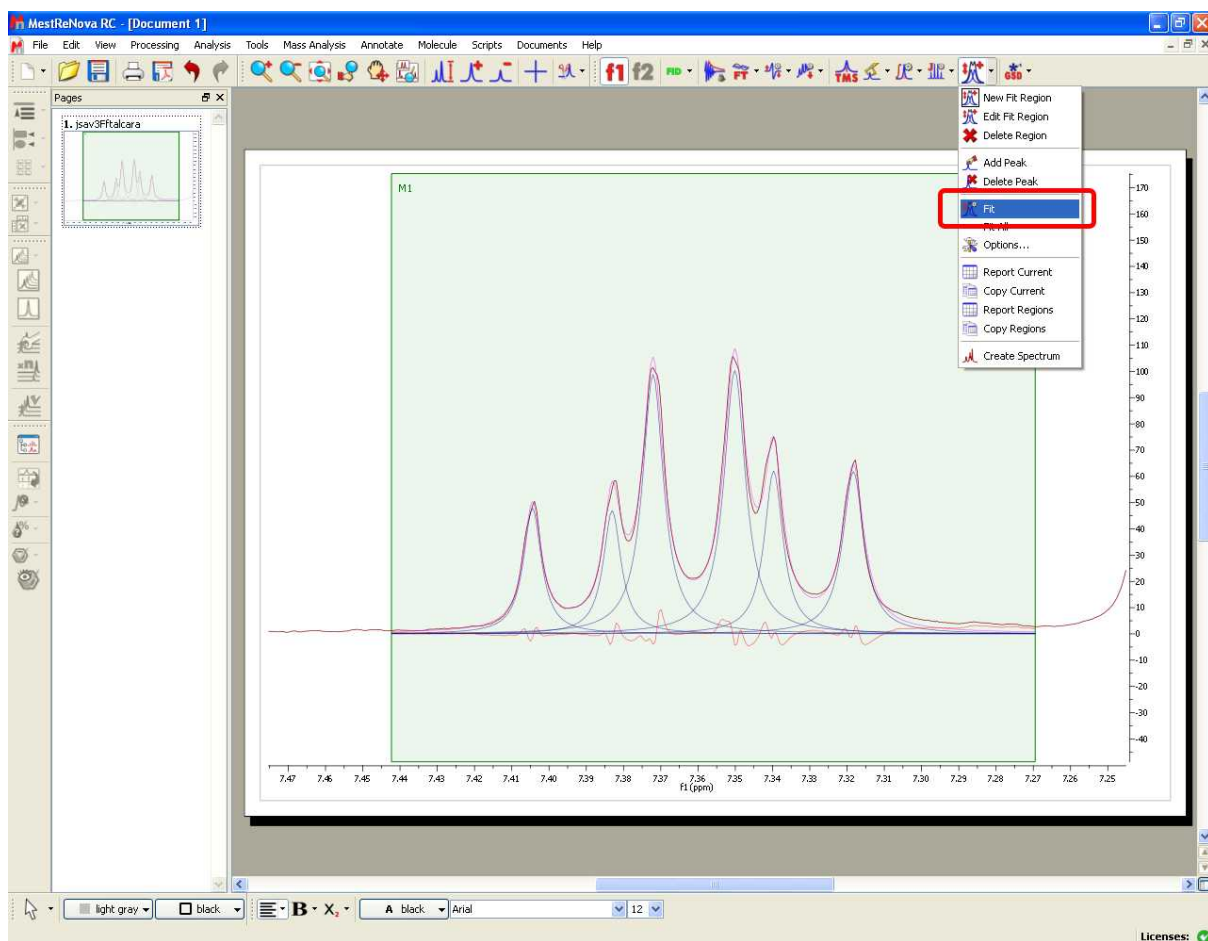

You will notice that the residue, the fit peak and the sum lines have changed. They constitute a starting point for the fitting (unless you are happy with the first fitting). If you are not happy with the initial fitting; you can add/remove components and change their parameters, just by selecting 'Edit Fit Region' in the 'Line Fitting' scroll down menu. This will display the 'Line Fitting' panel, where you will find information about the peaks of interest (the chemical shift, in ppm; the Height, the Width, in Hz; the Lorentzian /Gaussian ratio and the Area).

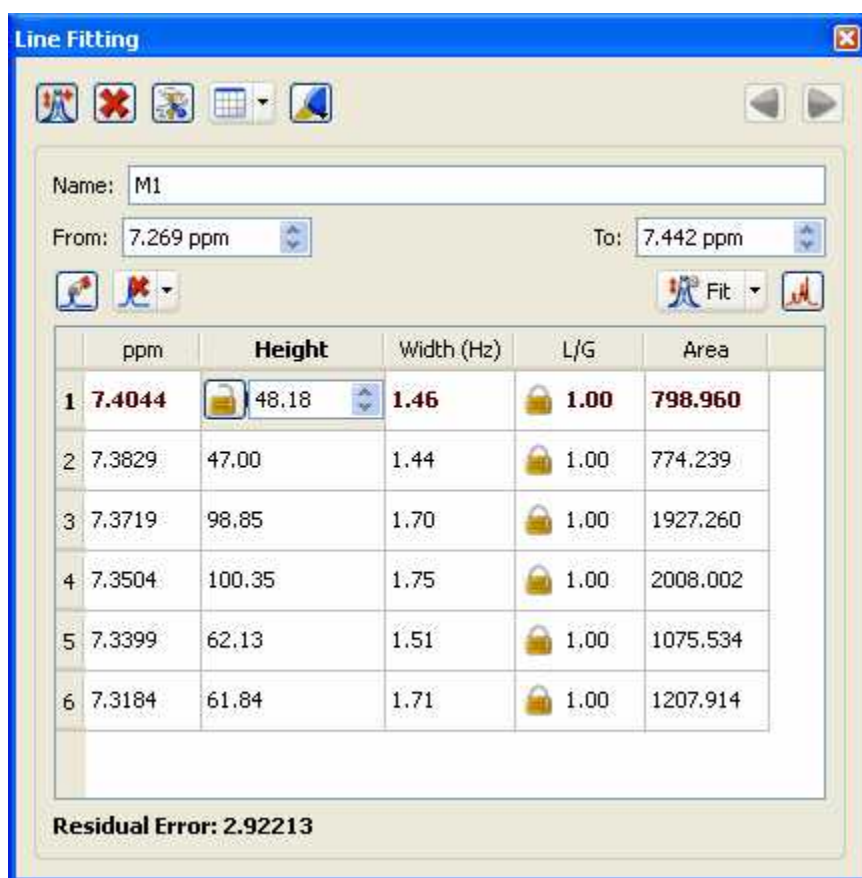

These parameters can be changed interactively over the spectrum (just by clicking and dragging over the green little squares) or by double clicking on each cell of the Line Fitting panel. Changes on any parameter will obviously affect to the 'Residual Error' (the smaller error, the better). For each point of the region, Mnova calculates the difference between the experimental and theoretical points, this value is powered by two and Mnova calculates the average of all the errors in the region of interest.

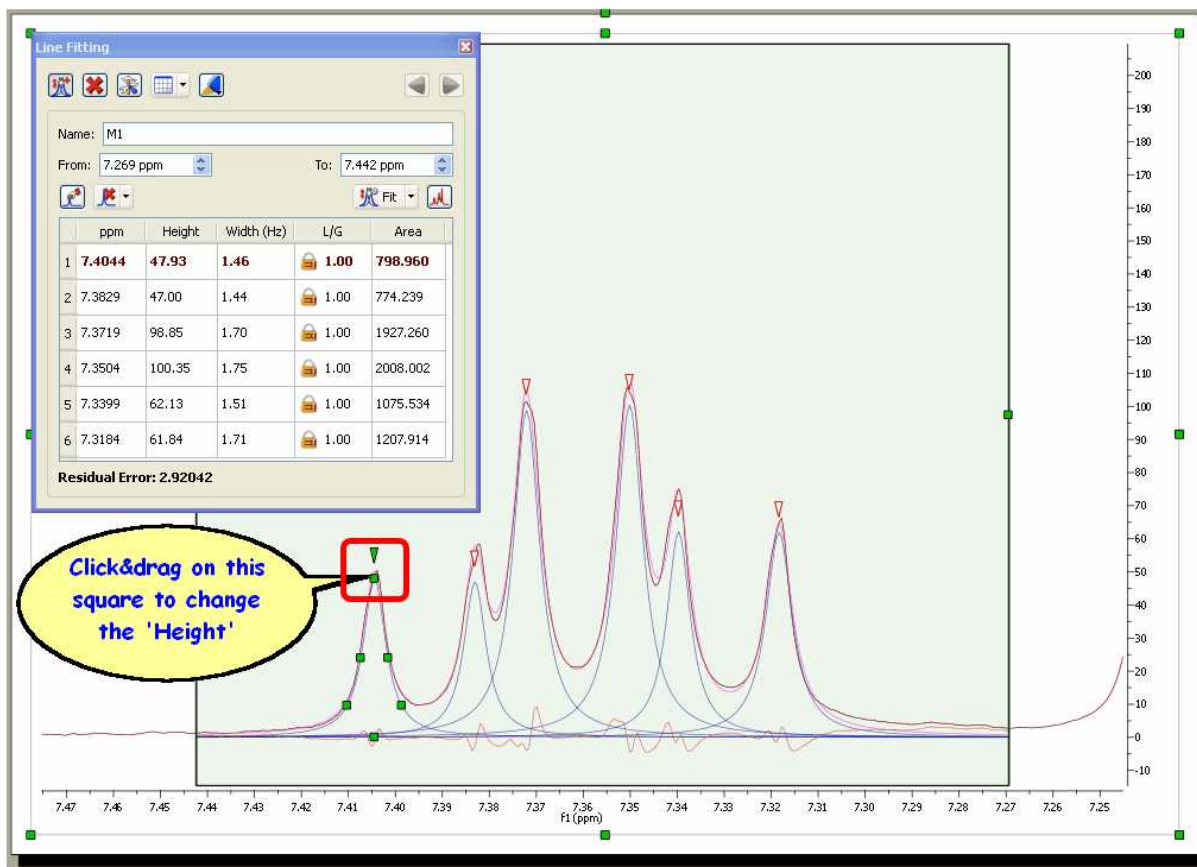

Clicking and dragging the green square at the top of the peak, will change the Height of the peak. The squares at the mid-height of the peak can be used to modify the Width of the peak:

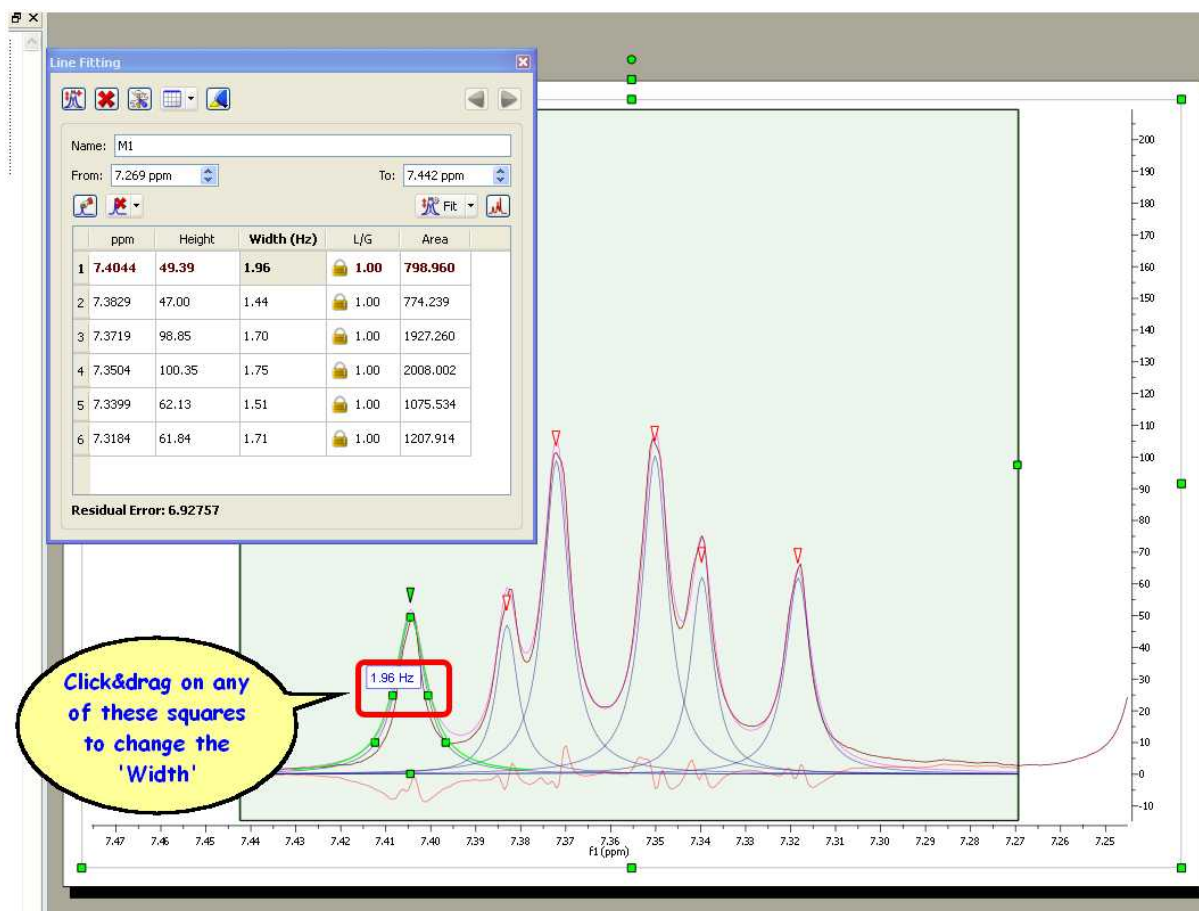

Clicking and dragging on the next two squares will modify the Lorentzian/Gaussian ratio of the signal and finally the last square will be used to modify the chemical shift of the signal.

Clicking on the red triangles will set the active peak:

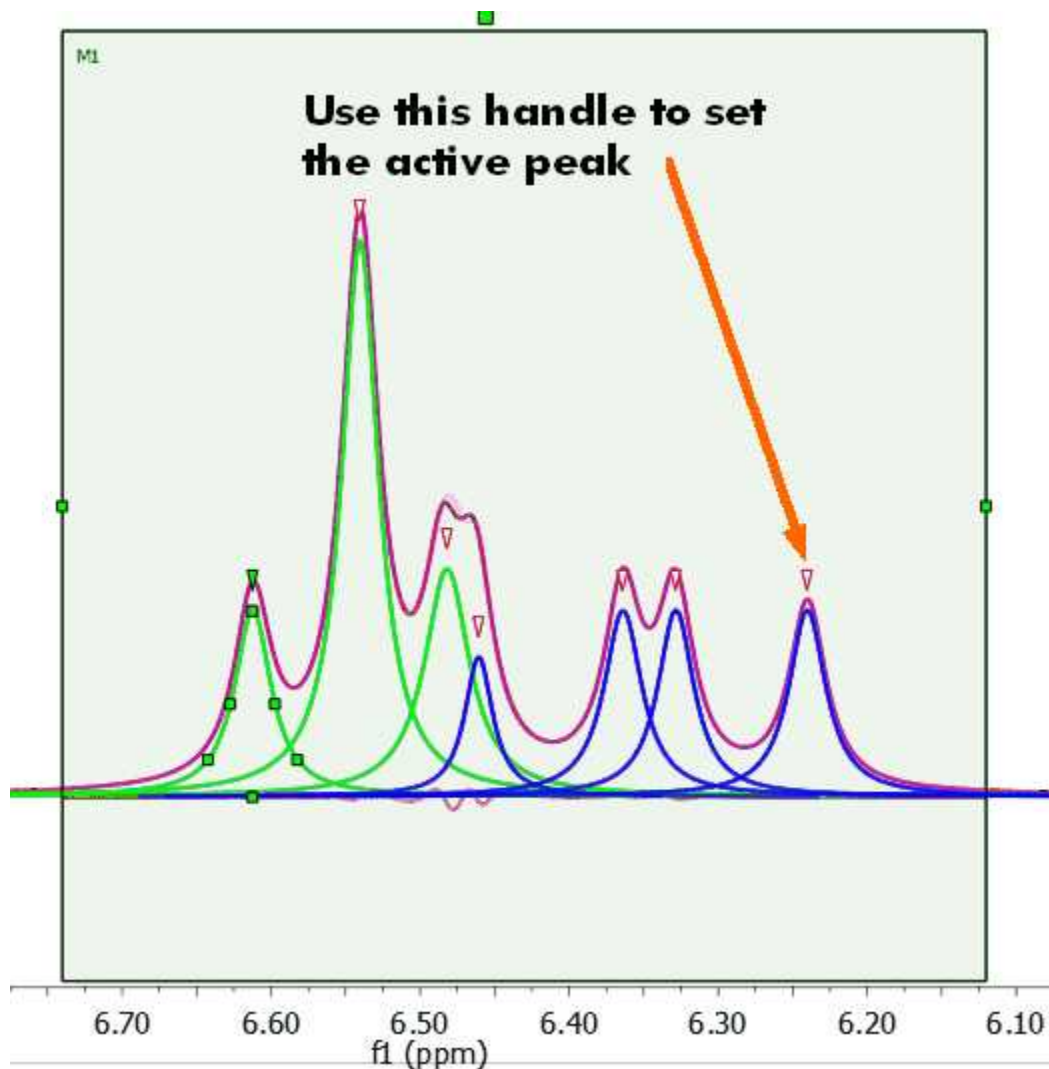

Any of these parameters can be locked for the Fit, just by double clicking on the applicable cell of the panel and closing the lock which appears. In the picture below it is shown how we have locked the width parameter of the peak 1 and also the L/G ratio of all the peaks, so these parameters will not change when the fitting will be applied. So a lock in front of a value indicates that it will not be optimized in the fitting.

L/G ratio: it does not pretend to be a mathematic representation. It is like a ratio between L and G.

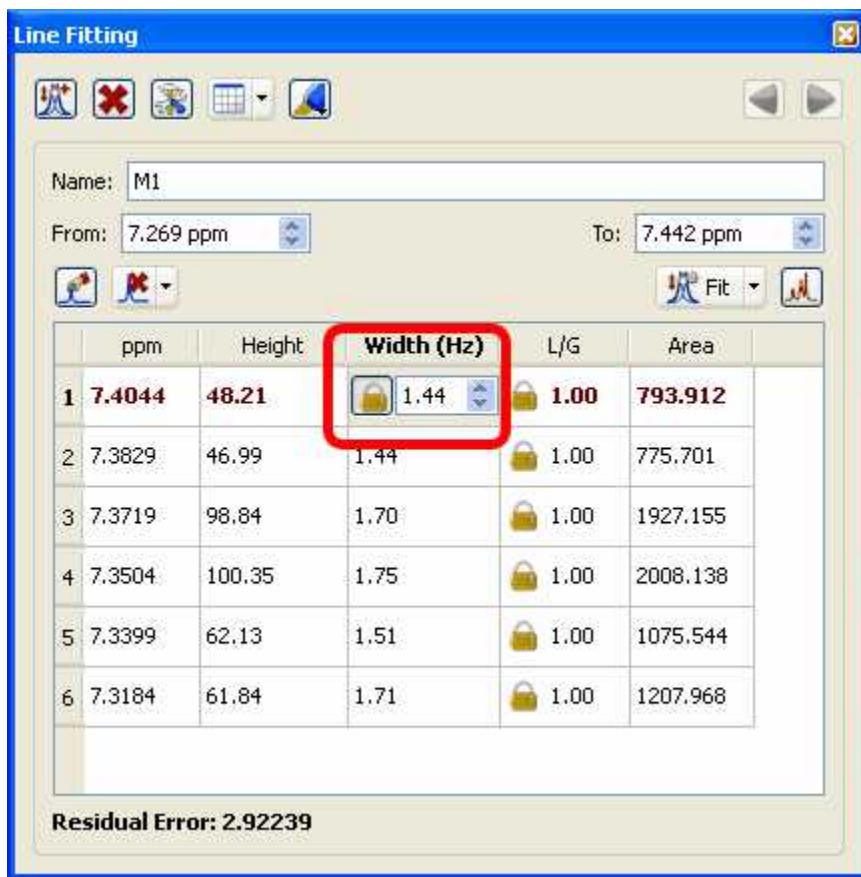

The value of the function to be fit would be:

$$LG(x) = LGFactor * L(x) + (1-LGFactor) * G(x)$$

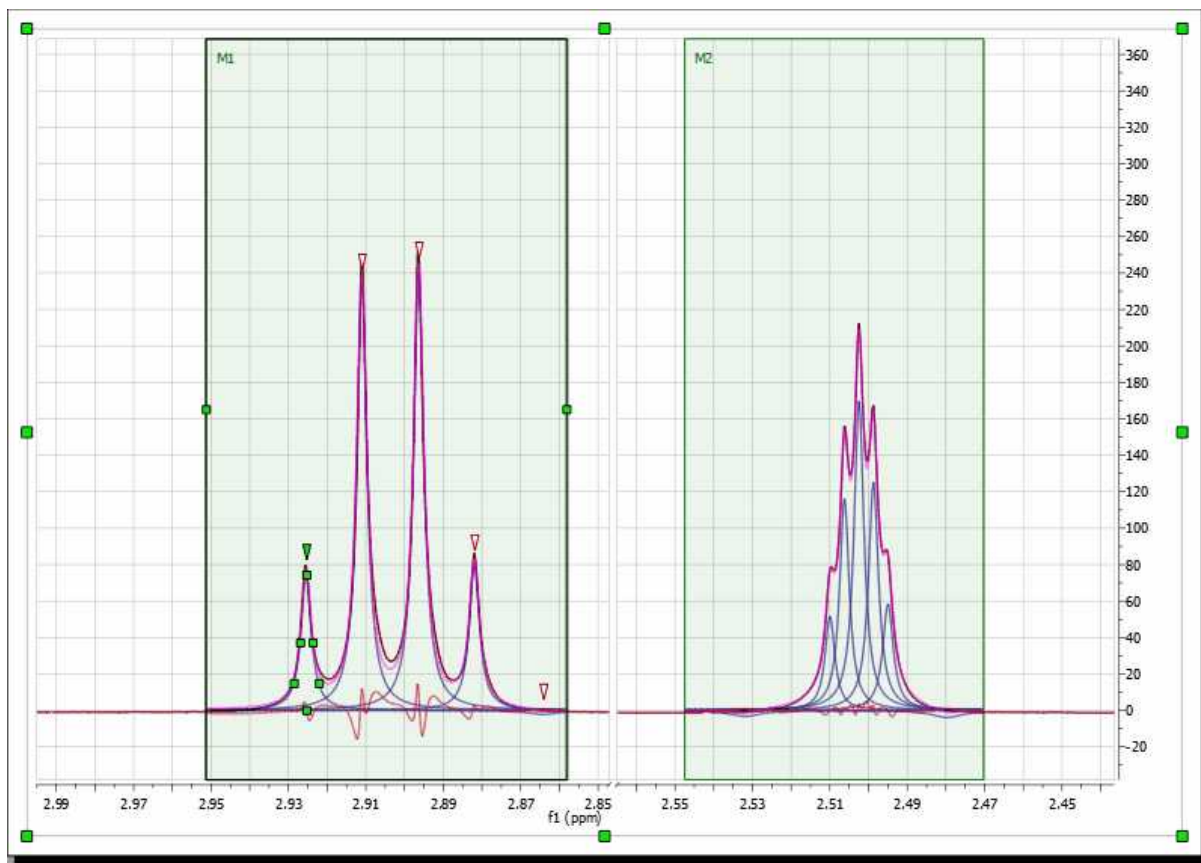

Of course you can fit several regions within a single spectrum, just by selecting a 'New Fit Region':



Once you are happy with all the parameters, you will only need to apply a new Fit, just by clicking on this icon . If you have several regions, you will need to select 'Fit All' in the Fit scroll down menu. Once the fitting has been made, if you want to get the Fitted spectrum just click on the 'Create spectrum' icon .

You can also use the Line Fitting feature for the simultaneous fitting across arrayed spectra. Just select the region and the fitting will take place along all the arrayed spectra:

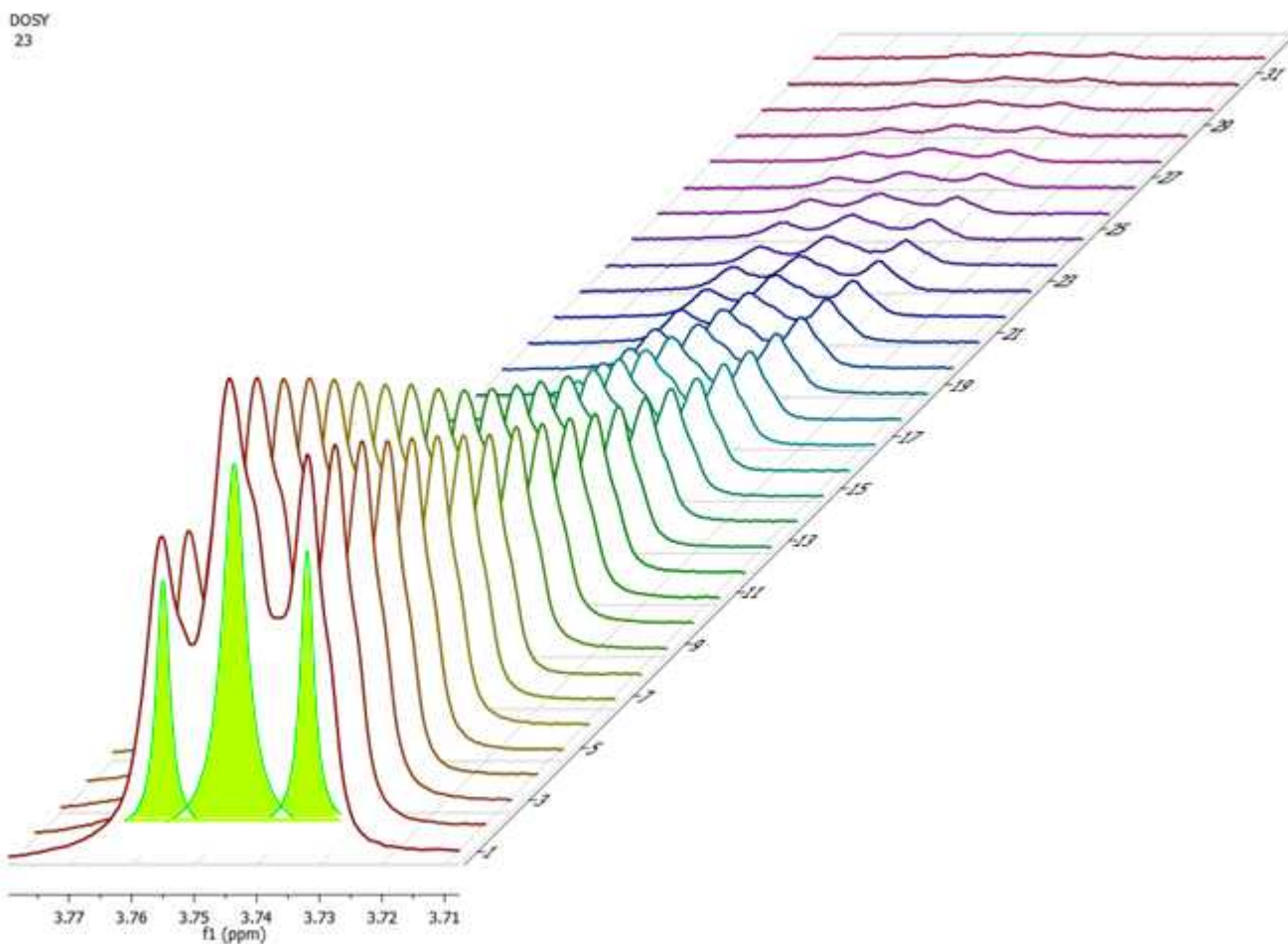



It will be possible to export the results in a .txt file by following the menu 'Scripts/Export ASCII/Fit Regions'.

Other Options of the Line Fitting panel

The Line Fitting panel includes other tools, let's see the meaning of them:

New Fit region:  use this icon to create another region to be fit.

Delete region:  to delete the current region.

Fitting Options:  to display the Fitting Options window where the user will be able to establish some constraints for the fitting. Line Widths and Chemical Shift parameters can be constrained within user-defined values:

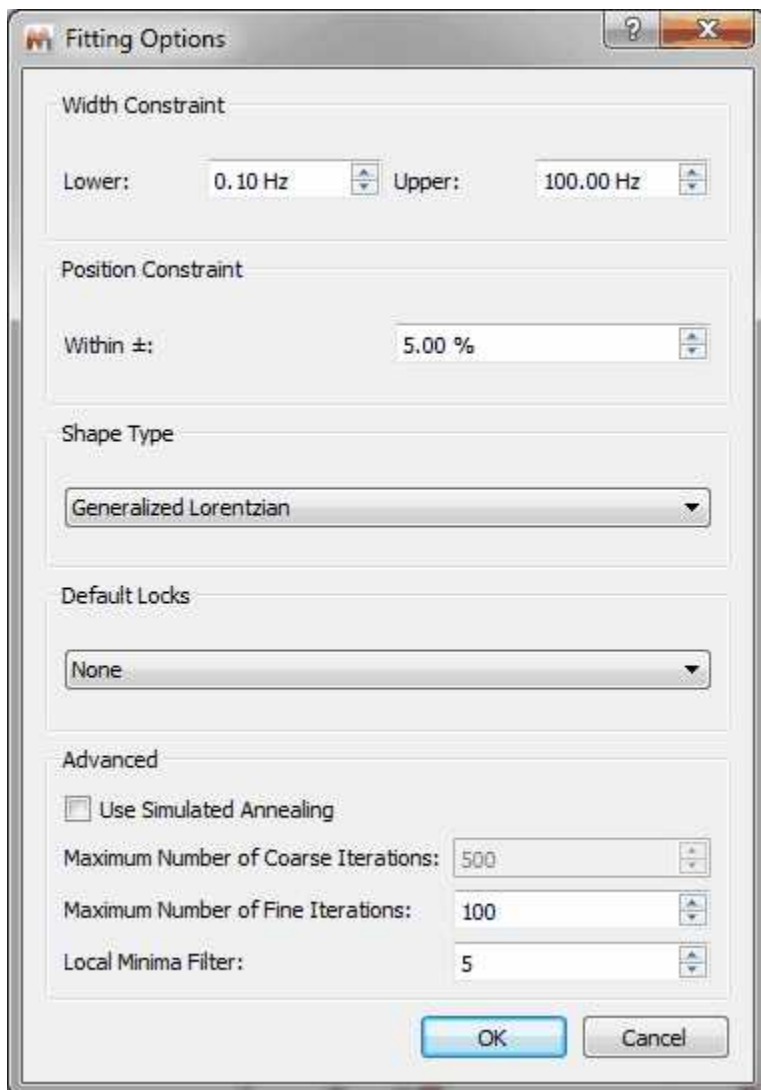

If the spectrum contains broad signals, just increase the Width Constraint to get good results. In the example below the Upper width constraint has been increased to 100 Hz:

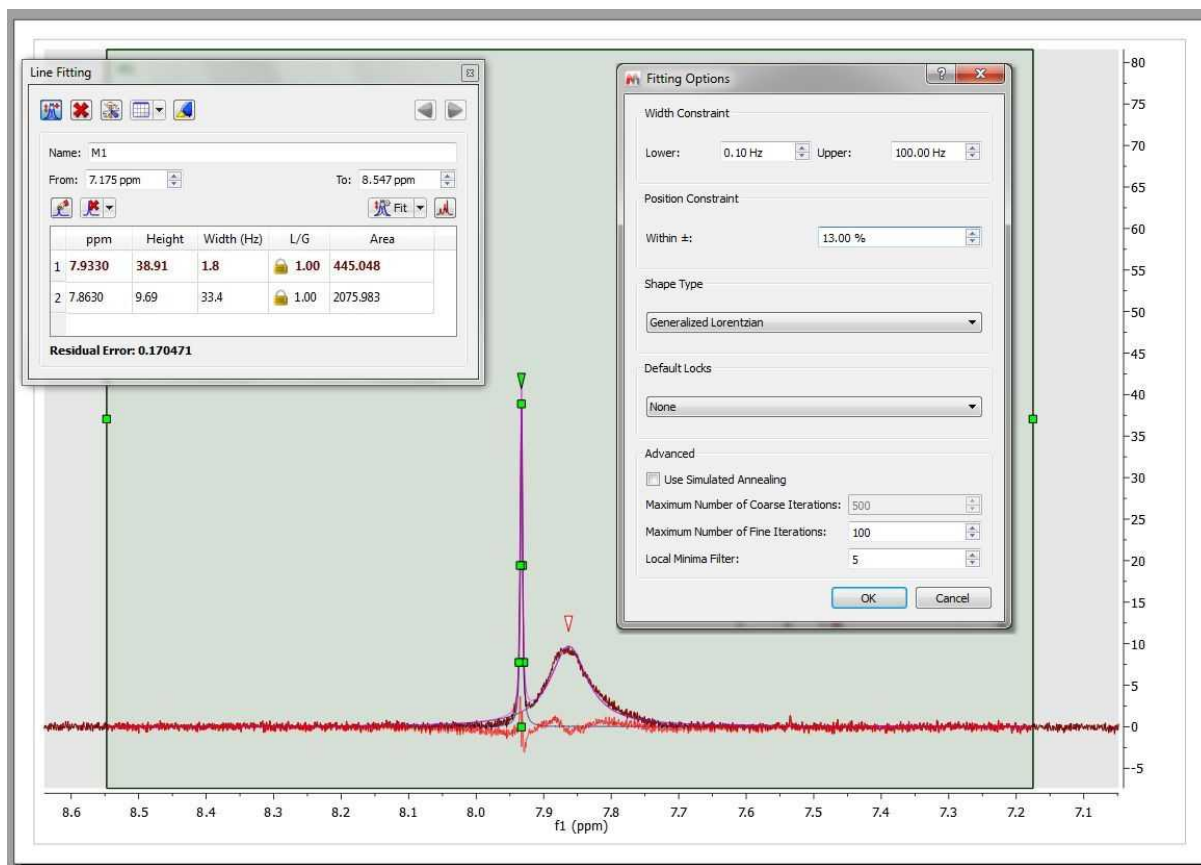

Position Constraint: it takes into account the values outside the range ($p=\text{shift}$) $p*(1-\text{pos_constraint}*p)$. A big value of the algorithm will 'shift' the peak far. Normally, you will not need to change the default value, because the peak should be close to the original position.

Shape Type: you can select between 'Generalized Lorentzian' or 'Lorentzian-Gaussian'.

'Generalized Lorentzian': The new generalized NMR peak shape profile proposed (which is a Lorentzian plus a factor by another function), generalizes the ubiquitous Lorentzian shape. The mathematical expression for the profile function contains only one extra parameter in addition to the three parameters of the Lorentzian line (location, height, and width). The new parameter does not interfere with any of the three 'classical' parameters (orthogonality) but affects the peak's kurtosis (for this reason we call it the kurtosis parameter). It is a-dimensional and has a 'natural' physical range of -1.0 to 2.0 (beyond these limits the formula is still operative but the peak profile starts splitting into a doublet or triplet). There are strong physical and conceptual reasons to expect that the new family of shape profiles will be much more useful in NMR spectroscopy than any of the often-used mixtures of Lorentzian and Gaussian shapes. In particular, we expect it to improve the quality of quantitative assays through NMR spectra and help the process of automatic editing of NMR peaks prior to structure verification.

The equation used for the 'Generalized Lorentzian' is shown below:

$$GL(x; p) = (1 - p)L(x) + pG(x)$$

where: $G(x) = \frac{1 + x^2/2}{1 + x^2 + x^4}$ and p is the kurtosis parameter.

NOTE: When a GSD peak picking is done the assumed peak shape is the Generalized Lorentzian.

Default Locks: you can select from here what parameters you want to lock by default.

Use Simulated Annealing: coarse fitting algorithm which will look for random solutions, keeping the best one as starting point for the *Fine Line Fitting* in order to get a better solution. The user will need to select the Maximum Number or coarse iterations (to find the initial starting point). This algorithm will be faster but less precise than the Fine Line Fitting.

Local Minima Filter: the algorithm uses a variation method to find the solution. With the initial parameters, it calculates the difference between the result and the real curve; after that, it modifies a little these parameters to achieve the real curve.

The iterations stop when you reach the maximum number of iterations, when the difference with the real curve is too small (this is not customizable), or when after several iterations, the variation of the parameters does not improve the fitting result. This parameter controls how much the parameters vary on each iteration. A high value means that the parameters change a lot on each iteration, which will be very useful in those cases where the initial curve is really different with the real curve. The user should not need to change this value.

Report Current:  to report the Line Fitting panel. This icon includes a scroll down menu to copy the report to the clipboard, report or copy the fit regions or customize the format of the report.

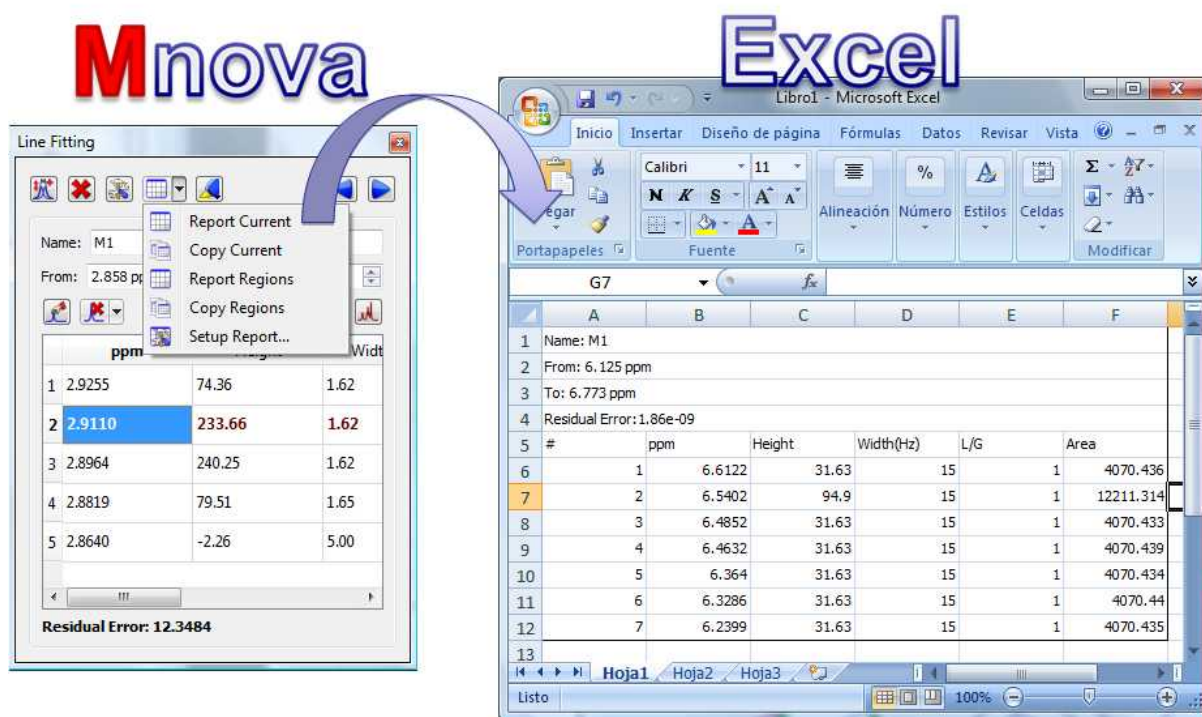

It will be also possible to export the results in a .txt file by following the menu 'Scripts/Export ASCII/Fit Regions'.

The format of this report can be also customized by following the menu 'Advanced/Line Fitting/Setup Report'. You can also create reports by using the 'Line Fitting' scroll down menu:

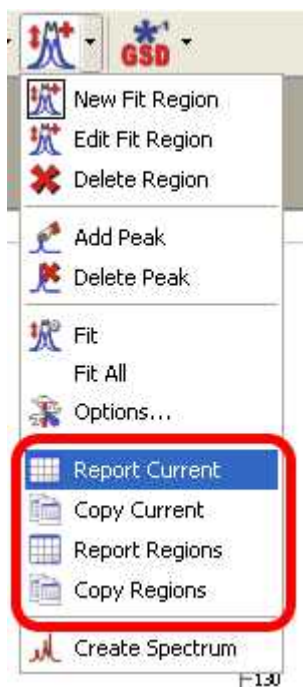



Select Lines to Show:  toggle button to show or hide the fitting lines (peaks, sums or residues)

Previous/Next Region :   to navigate through the fit regions.

Name: to change the name of the fit region.

From/To: to change the range of the fit region.

Add Peak:  to add a new peak to the region

Delete Peak:  to delete the current peak of the region (or all peaks at the same time)

Create spectrum:  To generate a new spectrum from the fit regions.

10.1.1 Line Fitting Properties

It is possible to customize the colours (and transparency) of the Fit regions, label and lines (Peaks, Sum and residue) from the 'Properties' dialog box, which can be accessed by double clicking on the spectral window and selecting 'Fitting' in the left tabbed menu

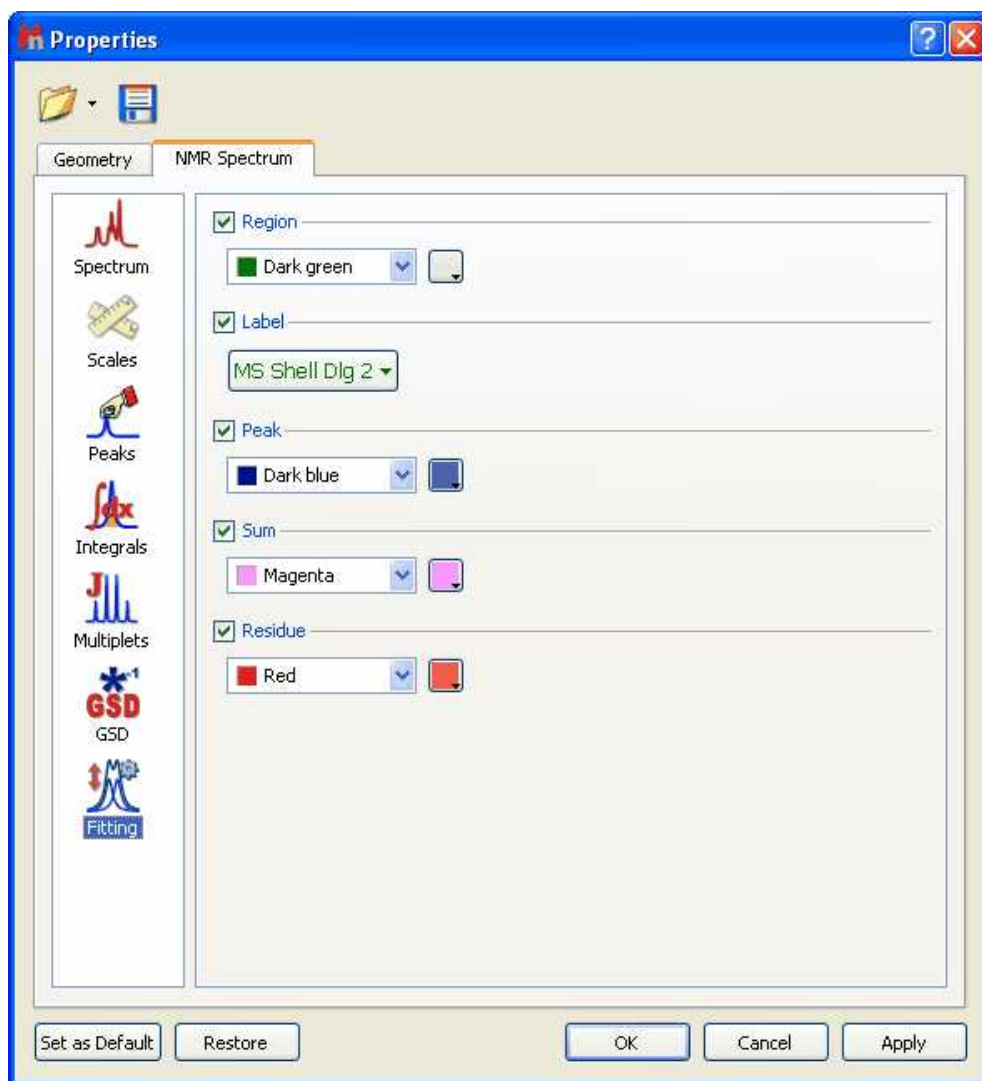

10.2 Bayesian DOSY Transform

(Not available in Mnova Lite)

NMR diffusion experiments provide a way to separate the different compounds in a mixture based on the differing translation diffusion coefficients (and therefore differences in the size and shape of the molecule, as well as physical properties of the surrounding environment such as viscosity, temperature, etc) of each chemical species in solution. In a certain way, it can be regarded as a special chromatographic method for physical component separation, but unlike those techniques, it does not require any particular sample preparation or chromatographic method optimization and maintains the innate chemical environment of the sample during analysis.

The measurement of diffusion is carried out by observing the attenuation of the NMR signals during a pulsed field gradient experiment. The degree of attenuation is a function of the magnetic gradient pulse amplitude (G) and occurs at a rate proportional to the diffusion coefficient (D) of the molecule. Assuming that a line at a given (fixed) chemical shift f belongs to a single sample component A with a diffusion constant D_A , we have

$$S(\mathbf{f}, \mathbf{z}) = S_A(\mathbf{f}) \exp(-D_A \mathbf{z}) \quad (1)$$

where $S_A(\mathbf{f})$ is the spectral intensity of component A in zero gradient ('normal' spectrum of A), D_A is its diffusion coefficient and \mathbf{z} encodes the different gradient amplitudes used in the experiment.

Depending on the type of experiment, there are various formulae for \mathbf{z} in terms of the amplitude \mathbf{G} of the applied gradient and one or more timing parameters such as Δt (time between two pulse gradients, related to echo time) and τ (gradient pulse width). In the original Tanner-Stejskal method using two rectangular gradient pulses, for example,

$$\mathbf{z} = 2G^2 \Delta t \tau^2 \quad (2)$$

The above equation holds strictly for simple PFG-NMR experiments, and is modified slightly to accommodate more complicated pulse sequences.

In practice, a series of NMR diffusion spectra are acquired as a function of the gradient strength. For example, the figure below shows the results of a series of ^1H -NMR diffusion experiments for a mixture containing caffeine, 2-Ethoxyethanol and water.

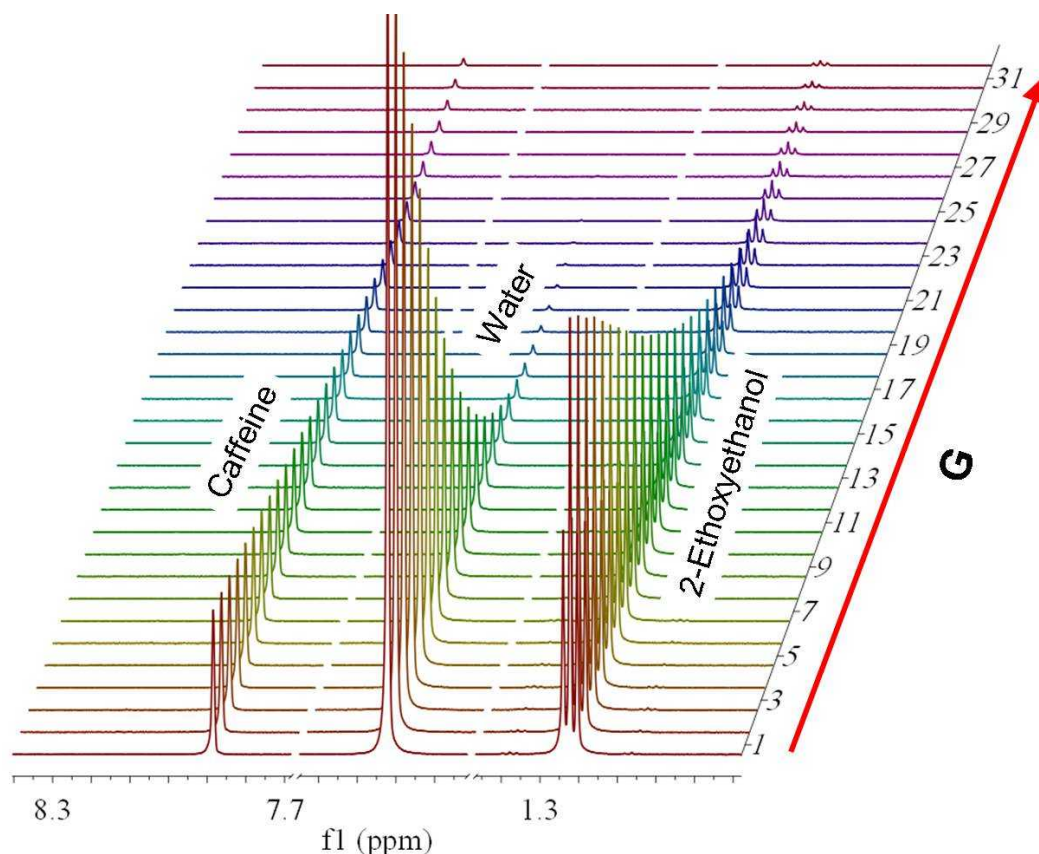

It can be observed that the intensities of the resonances follow an exponential decay. The slope of this

decay is proportional to the diffusion coefficient according to equation (1). All signals corresponding to the same molecular species will decay at the same rate. For example, peaks applicable to water decay faster than the peaks of caffeine and 2-Ethoxyethanol

The DOSY transformation

As far as data processing of raw PFG-NMR spectra is concerned, the goal is to transform the $N \times M$ data matrix S into an $N \times R$ matrix (2D DOSY spectrum) as follows:

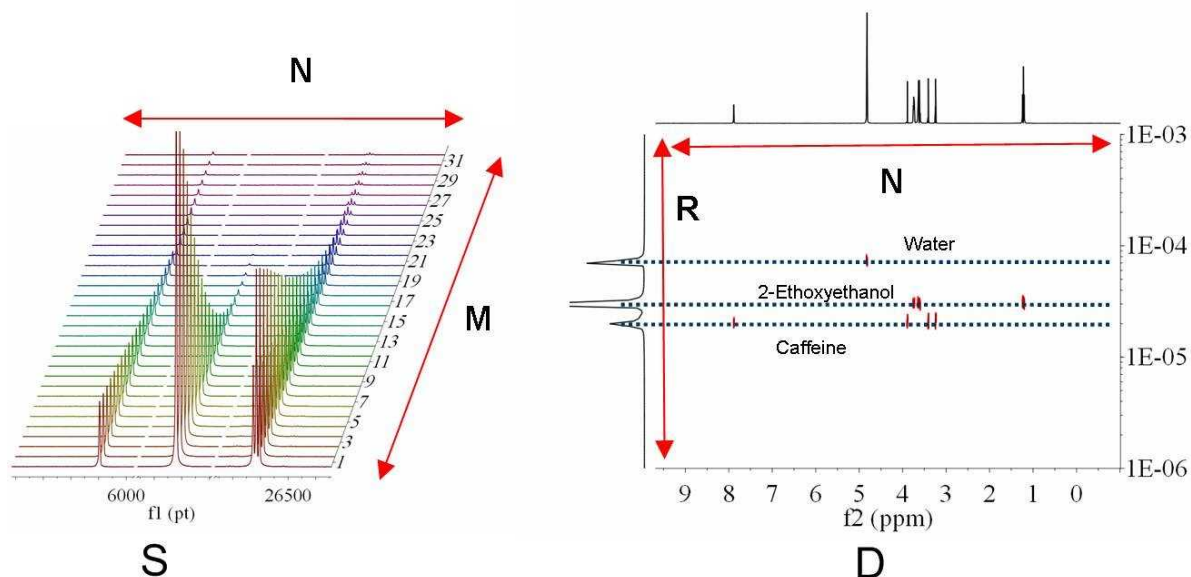

The horizontal axis of the DOSY map D is identical to that of S and encodes the chemical shift of the nucleus observed (general 1H). The vertical dimension, however, encodes the diffusion constant D . This is termed **Diffusion Ordered Spectroscopy** (DOSY) NMR. In the ideal case of non-overlapping component lines and no chemical exchange, the 2D peaks align themselves along horizontal lines, each corresponding to one sample component (molecule).

The horizontal cut along such a line should show that component's 'normal' spectrum. Vertical cuts show the diffusion peaks at positions defining the corresponding diffusion constants.

The **mapping $S \Rightarrow D$** will be henceforth called the DOSY transformation. This transformation is, unfortunately, far from straightforward. Practical implementations include mono and biexponential fitting, Maximum Entropy, and multivariate methods such as DECRA.

We have recently developed a brand new method for DOSY processing which has been included in [Mnova](#).

Bayesian DOSY Transform

Let's see how this feature works step by step:

1. **Import your raw data:** for example by dragging the spectrum folder into Mnova:

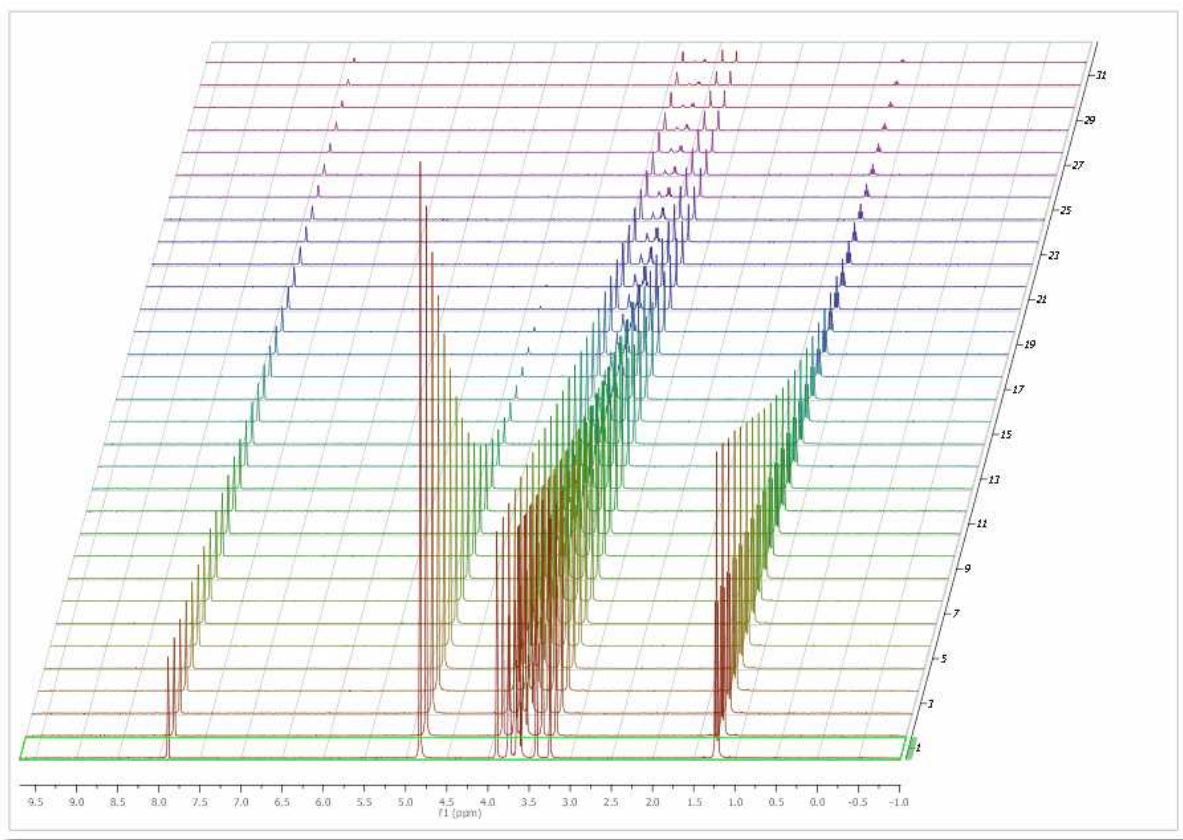

2. Process the spectrum: Mnova processes the spectrum automatically for you. However, it might be necessary to apply some further processing, usually manual phase and baseline correction

You can do that directly on the stacked plot mode, but it's recommended to use the 'Active Spectrum' mode as depicted below:



Within the 'Active Spectrum' mode, correct any phase distortion and apply an automatic baseline correction (use Bernstein polynomials). These corrections will be applied to the whole dataset. You can also apply the [Align](#) tool (under the Advanced menu) if the traces are not aligned.

3. Setup Diffusion-related exp. values: Make sure that the big and little delta values have been correctly read from the experiment files by following the menu 'View/Tables/Arrayed Data' (or Stack 'Show Arrayed Data Table'). It is possible that these values cannot be properly read (we are still working on this issue).

**NOTE**

The gradient values are read from the difflist, whilst the small delta values are taken from Pulse Width (from P30 and PULPROG) in acquis file. A formula has to be used to calculate the value: $p30 \cdot 1.0e-6$. When the pulprog is bipolar (pulse sequence containing 'bp'), the value is multiplied by 2.

These values should be entered in seconds:

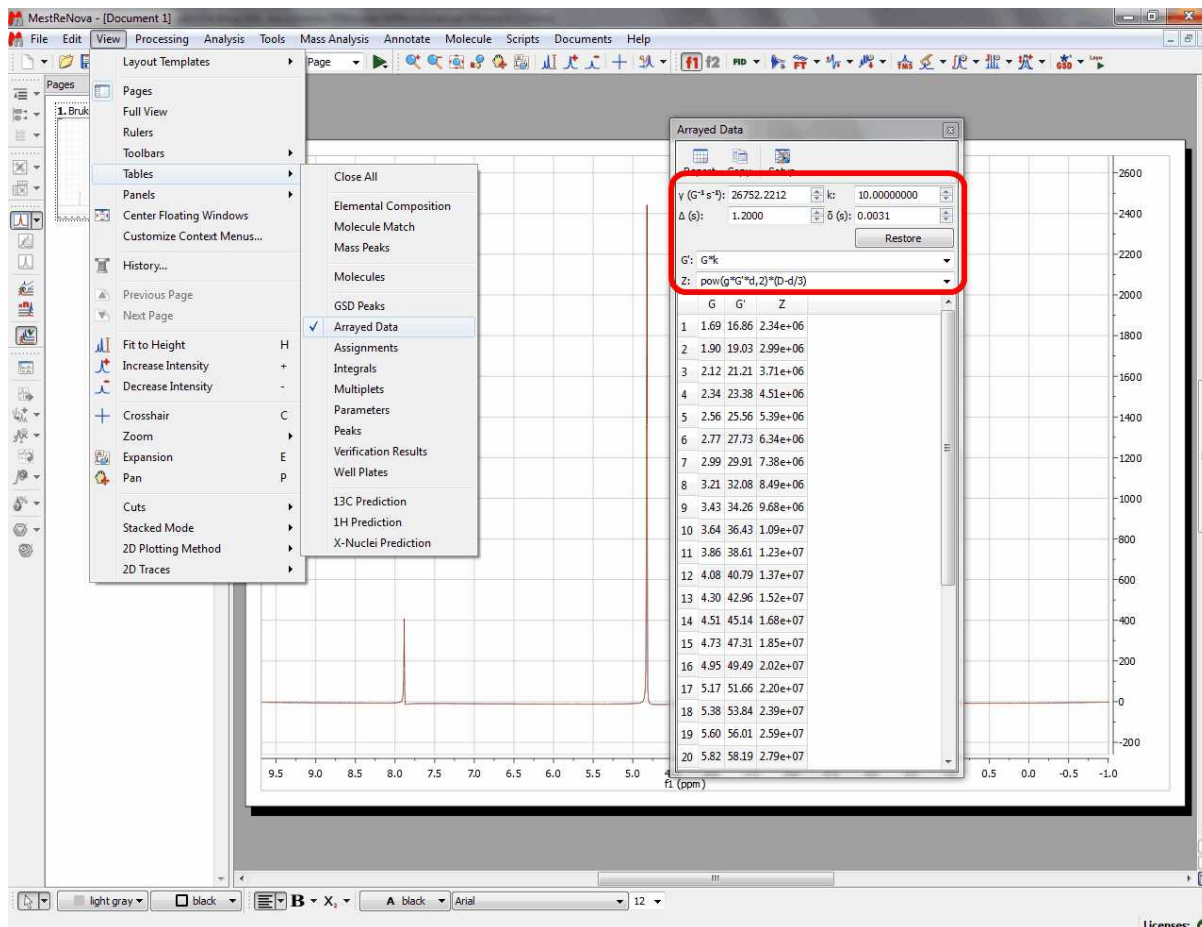

By means of the bayDOSY transform (BDT) we are fitting a model of the type

$$S(f,z) = S_A(f) \exp(-d_A z)$$

where $S_A(f)$ is the spectral intensity of component A in zero gradient ('normal' spectrum of A) and d_A is its diffusion coefficient. Z values corresponding to the expression above are displayed in the third column which are calculated according to the formula highlighted in the figure.

It's assumed that the gradient strength comes in G/cm. Note that the values used by the algorithm are those listed in the G' column which are in turn obtained from G column after multiplying these values by the k factor.

**NOTE**

Mnova will read the arrayed parameter directly from the metadata. However, it's possible that in some cases, the units are not in the correct format and thus Mnova gives the user the opportunity to scale the values parsed from the metadata by simply scaling those values by a factor k .

So what Mnova reads directly from the metadata is column G (or t in the case of Reaction-Monitoring or metabonomics examples), whilst column G' is the result of scaling G by the scaling factor k . Column Z is the final arrayed parameter, parameter which will be used in several other places such as DOSY transform, Data Analysis, etc.

4. **Run the Bayesian DOSY Transform:** Just by following the menu 'Advanced/Bayesian DOSY Transform'

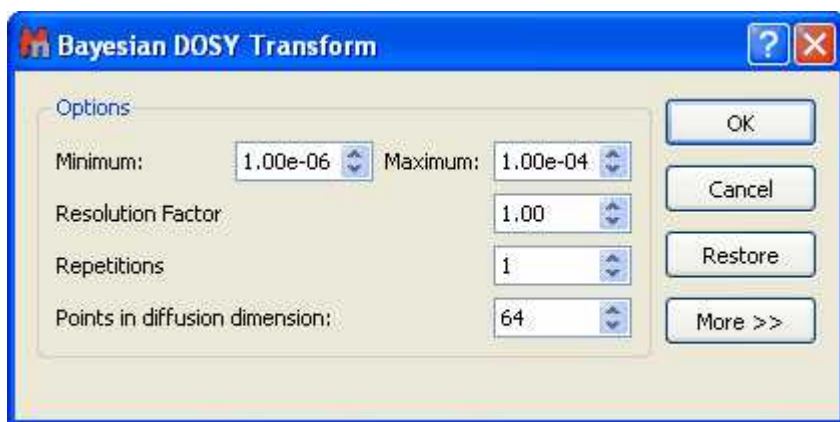

a) Enter the minimum and maximum expected diffusion values. If the gradient strengths have been introduced in G/cm, the resulting diffusion coefficients will be in cm^2/s

b) To start with, use a resolution factor of 1 (or 0.1). Higher values will increase the resolution along the diffusion dimension (vertical). However, small peaks can be missed when the resolution factor is too high

c) The number of repetitions should be kept to 0 for the first try. Next, if you want to further increase the vertical resolution, set this value to 1 or 2. This should drastically increase the resolution, though some artifacts might appear.

This is the result obtained. As you can see the 3 compounds (water, ethoxyethanol and caffeine) are perfectly separated.

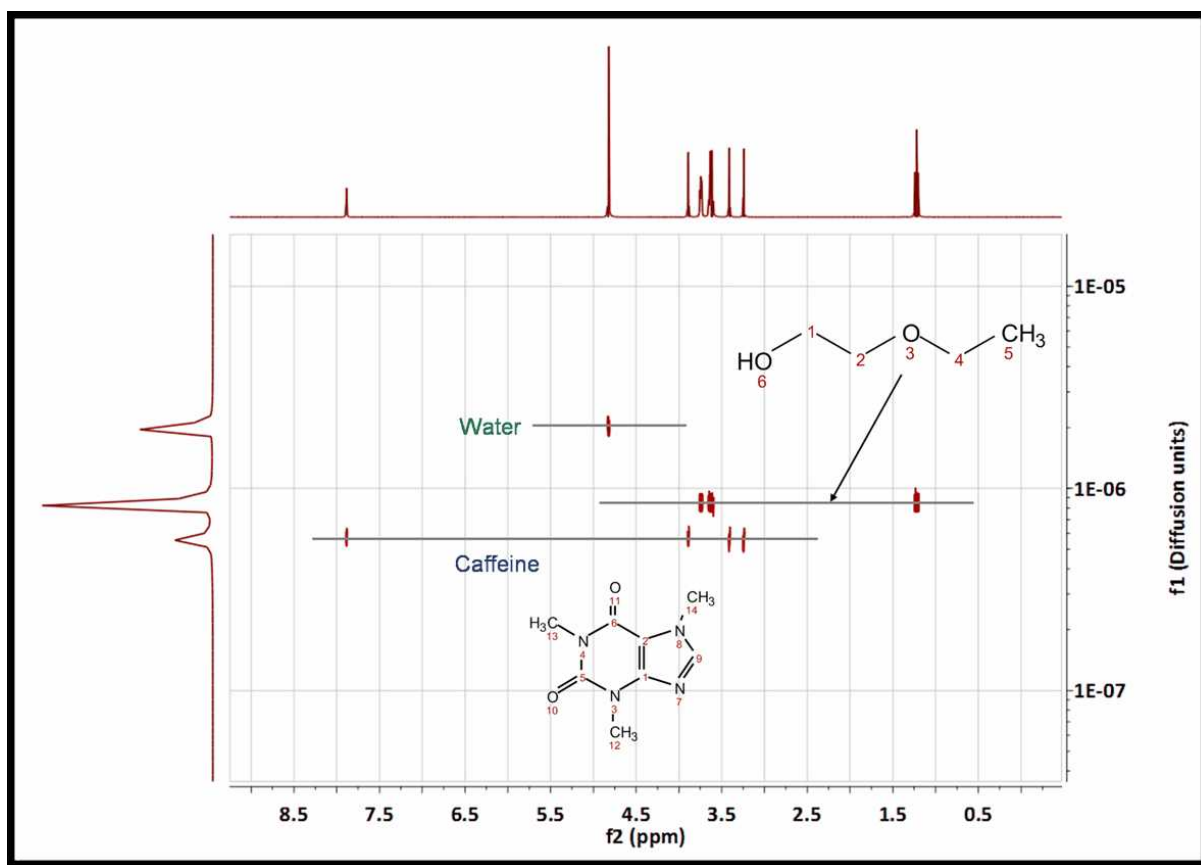

You can use the '[Crosshair](#)' to measure the Diffusion values.

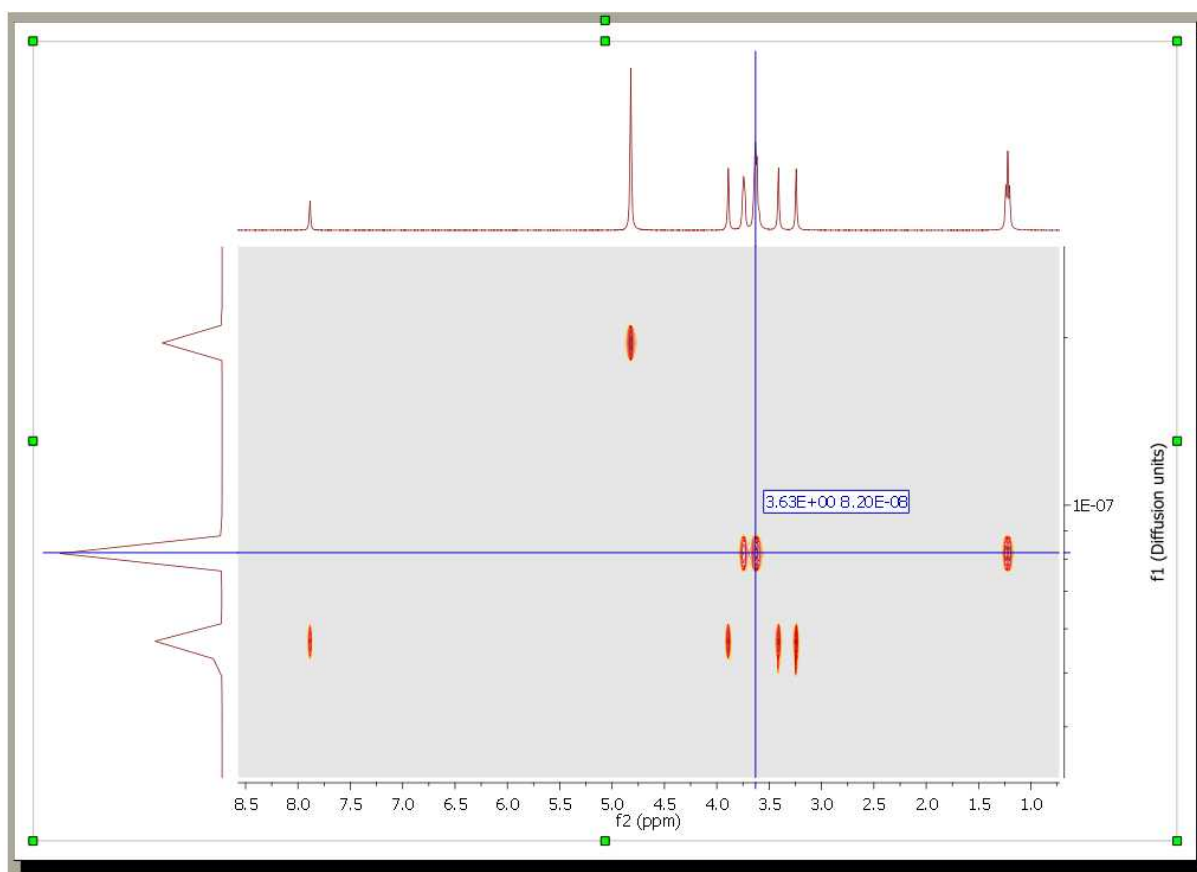

Please bear in mind that Bayesian DOSY Transform is a **quantitative method**. This will allow you to obtain the relation of each compound by just integrating the diffusion trace.

To do that, just right click on the trace and select 'Setup' in the contextual menu to display the 'Setup Traces' dialog box. Once there click on the 'blue arrow icon to extract the 'Vertical Trace'. Please make sure that this trace is the 'Internal Projection' (Sum)

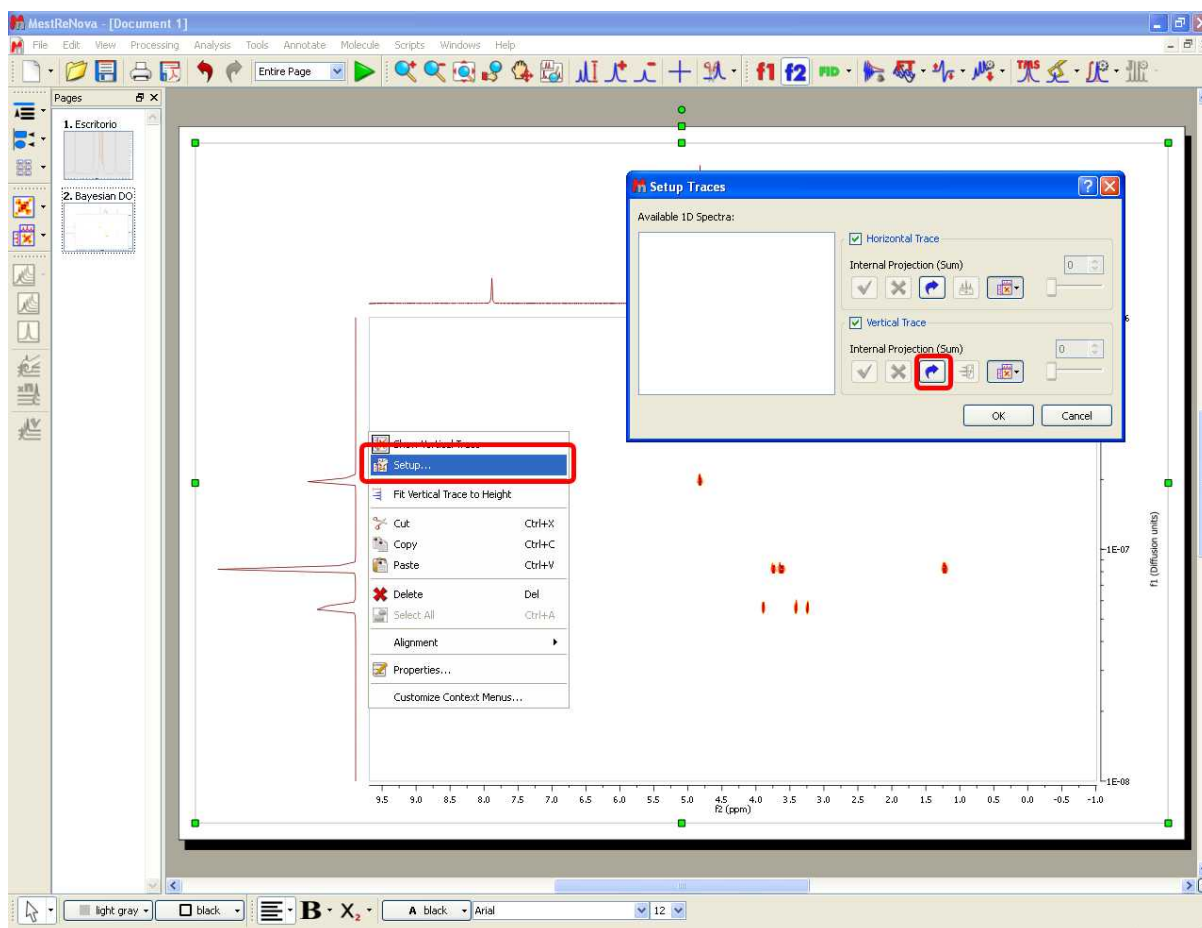

This will extract the trace to a new page. Finally integrate the signals of this trace to get the applicable ratio of the compounds:

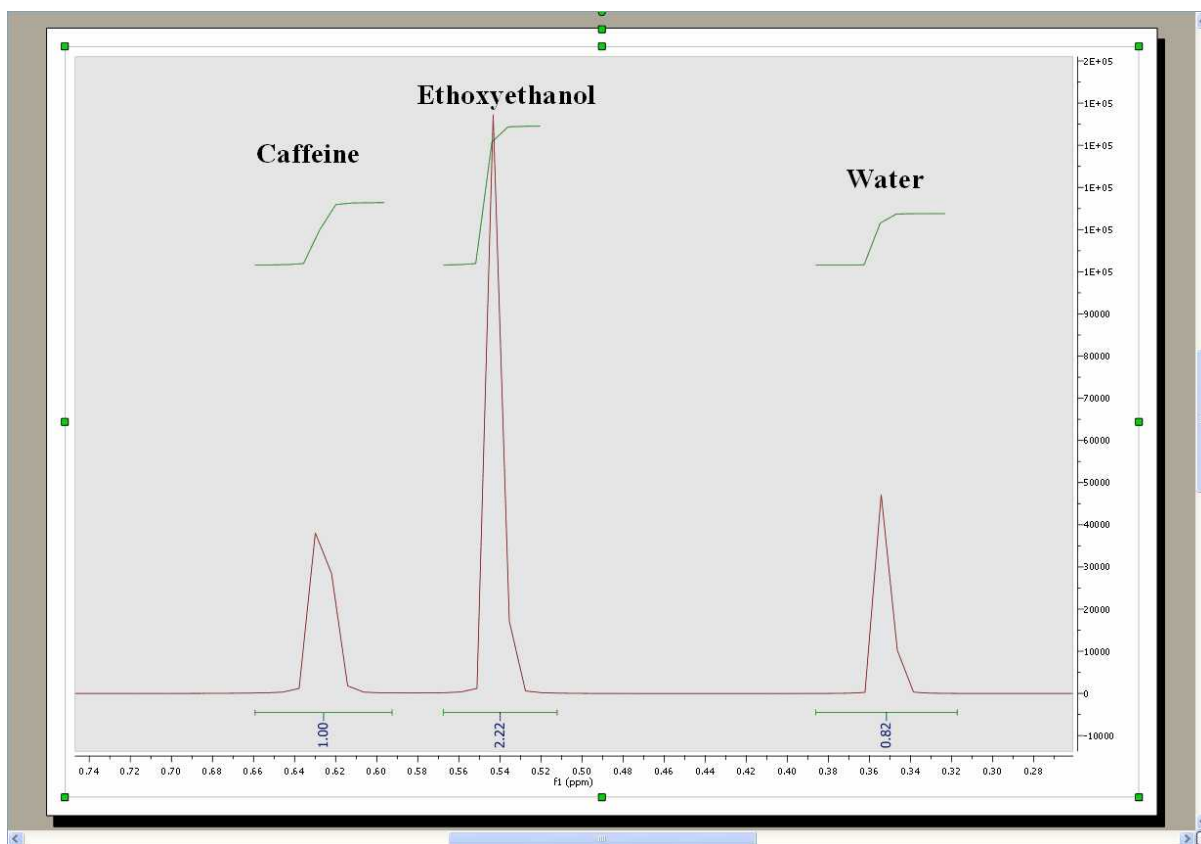

See an application of the GSD algorithm for DOSY processing [here](#)

10.3 Data Analysis Quick Start Guide

Let's see how this feature works. Just load your experiment into Mnova:

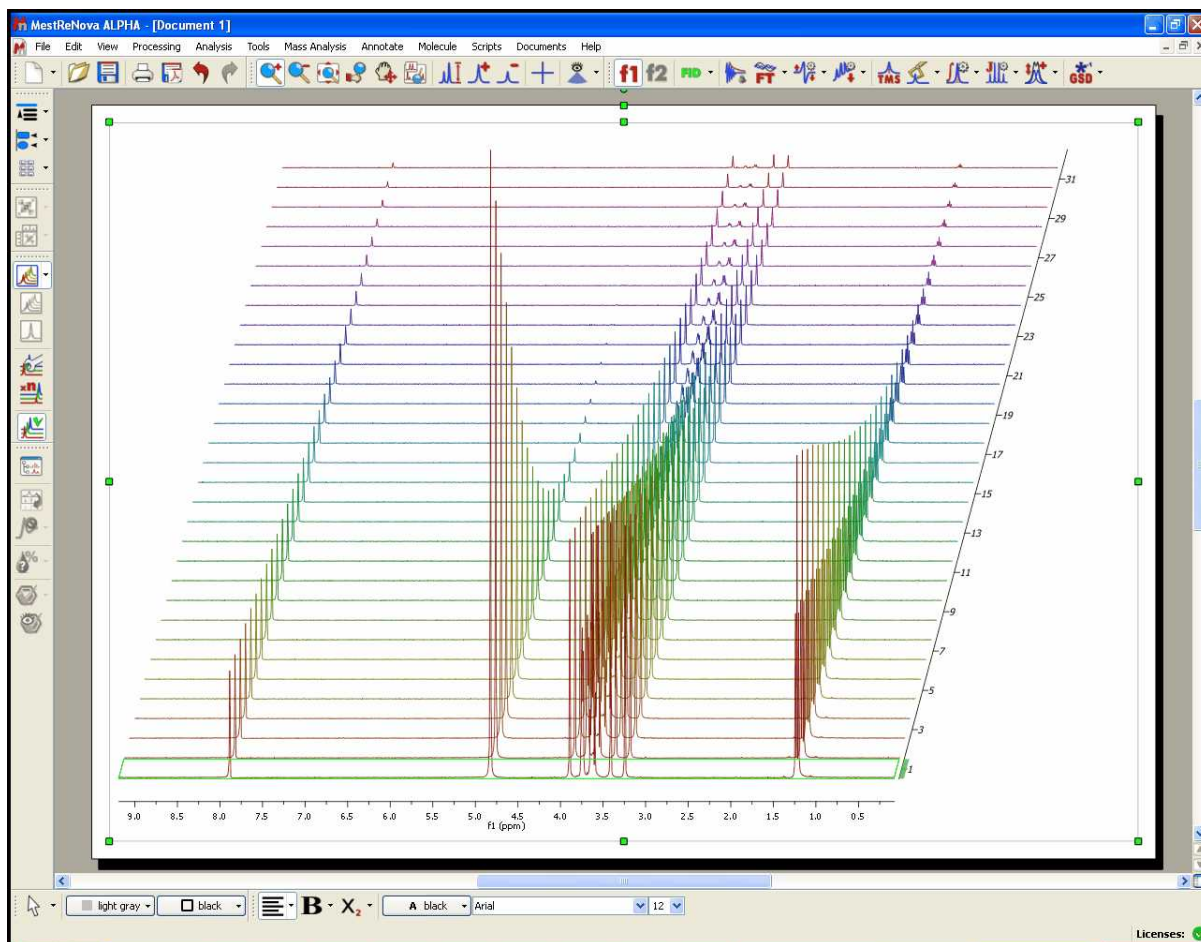

Follow the menu 'Advanced/Data Analysis/Create' and select the desired graphical representation. In that case 'Integrals Graph':

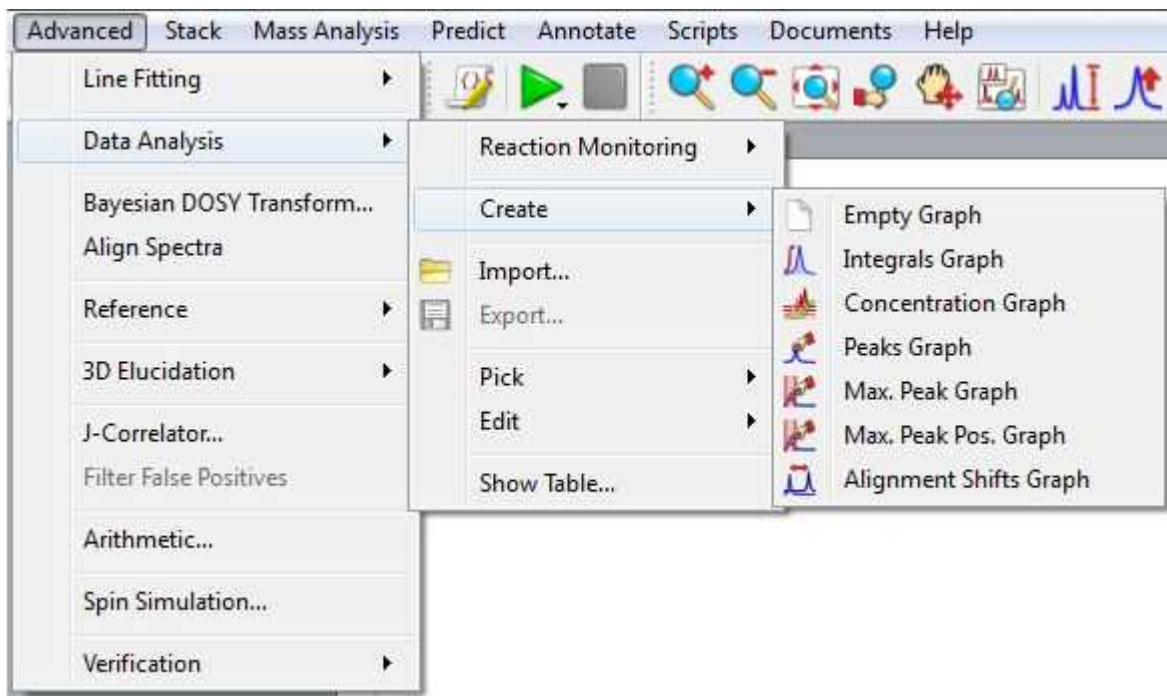

You will notice how the cursor will change to a blue integral. Now you will only need to integrate the desired signal (in this case, we will select the signal at 1.20 ppm). Once you have integrated the desired region, you will notice how the graphical will change according with the decay of the signal. Please bear in mind that all values will appear in a tabulated form in the [Data Analysis panel](#)

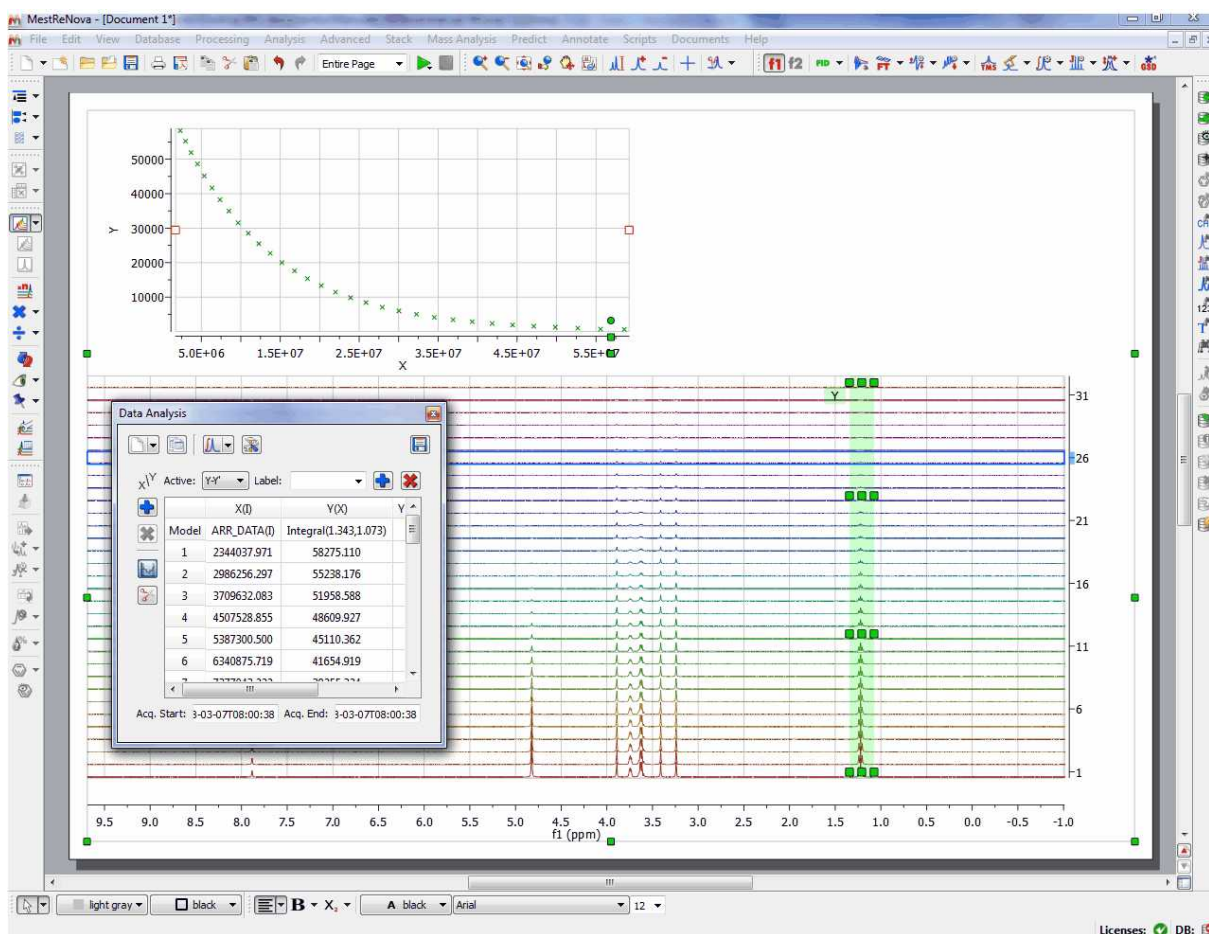

Finally, allow Mnova to try to guess the order of the reaction, fitting the data to standard equations and comparing the mean square error. To do it just follow the menu ' Advanced/Data Analysis/Edit/Fit to Best'.

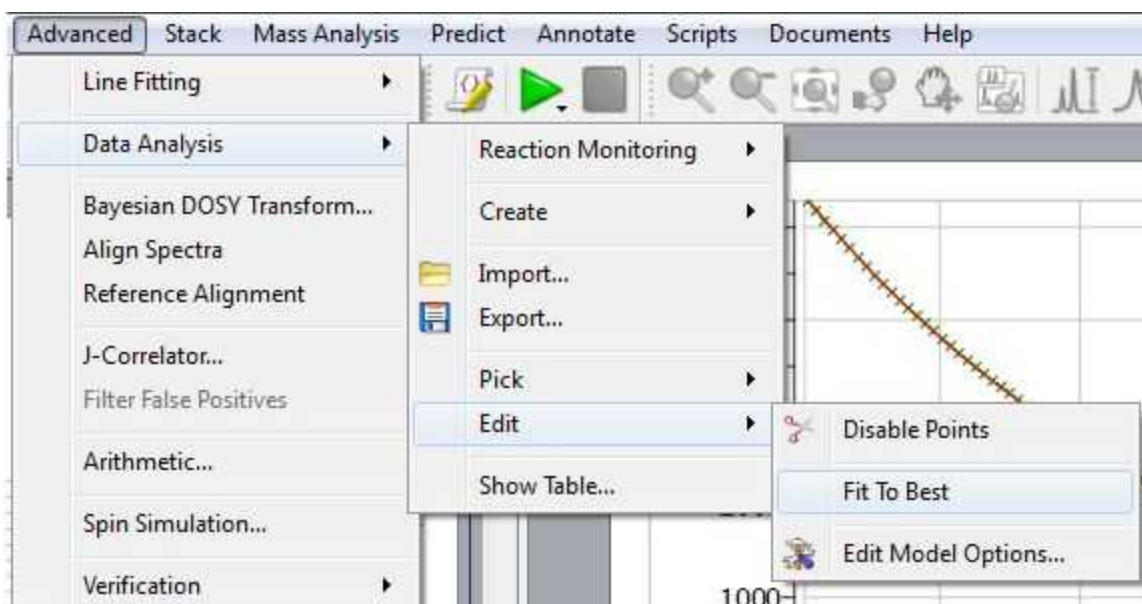

You will find the result of the fitting in the ['Data Analysis' panel](#) (View/Panels/Data Analysis). In that case, the best fit would be a 'Three Parameter Exponential'. If you are not happy with the fitting, just click on the first cell of the column Y'(X) to select any other function:

The **Data Analysis** panel displays the following data:

	X(t)	Y(X)	Y'(X)
Model	ARR_DATA(I)	Integral(1.345925,1.062739)	$B + F \exp(-x \cdot G)$ B= 150.298 F= 70557.2 G= 8.31648e-08
1	2.34404e+06	58320	58210.6
2	2.98626e+06	55281.8	55190.9
3	3.70963e+06	51992.5	51977.3
4	4.50753e+06	48643.1	48649.9
5	5.3873e+06	45142.2	45228.1
6	6.34088e+06	41687.3	41791.3
7	7.37704e+06	38291.3	38353.2
8	8.4863e+06	34952.7	34986.7
9	9.67886e+06	31601.7	31697.4
10	1.09438e+07	28526.6	28547.3
11	1.22928e+07	25541.4	25533.8

The **Y-Column Model Function** dialog box shows the following functions:

Name	Function	Initialization	Report	Description
1 Linear Fit	$A + B \cdot x$	A= 0, B= 0		Zero Order Reaction Rate
2 Mono-exponential Fit	$B \cdot \exp(-x \cdot F)$			Exponential Decay, First Order Reaction Rate
3 Three Parameter Exponential Fit	$B + F \cdot \exp(-x \cdot G)$			Exponential Decay, First Order Reaction Rate With Offset
4 Inverse Linear Fit	$1 / (A + B \cdot x)$	A= 1, B= 0		Second Order Reaction Rate
5				

Fitted Parameters:
 B= 150.298, F= 70557.2, G= 8.31648e-08
 Error= 8.97541e-11, probno= 1

10.3.1 Data Analysis

Mnova incorporates a **'Data Analysis'** feature for the analysis of diffusion experiments. This feature covers also relaxation (T1/T2) experiments, kinetics, reactions monitoring, etc.

With this feature, it will be possible to extract the peak intensities and integrals in a tabular form from series of 1D NMR experiments. The user will be able to draw graphical representations of the extracted values as well as any fit results. It will be also possible to get data modeling (fitting) of the extracted values to a user customizable analytical function.

Let's see how this feature works in the case of a diffusion sample. Just load your experiment into Mnova:

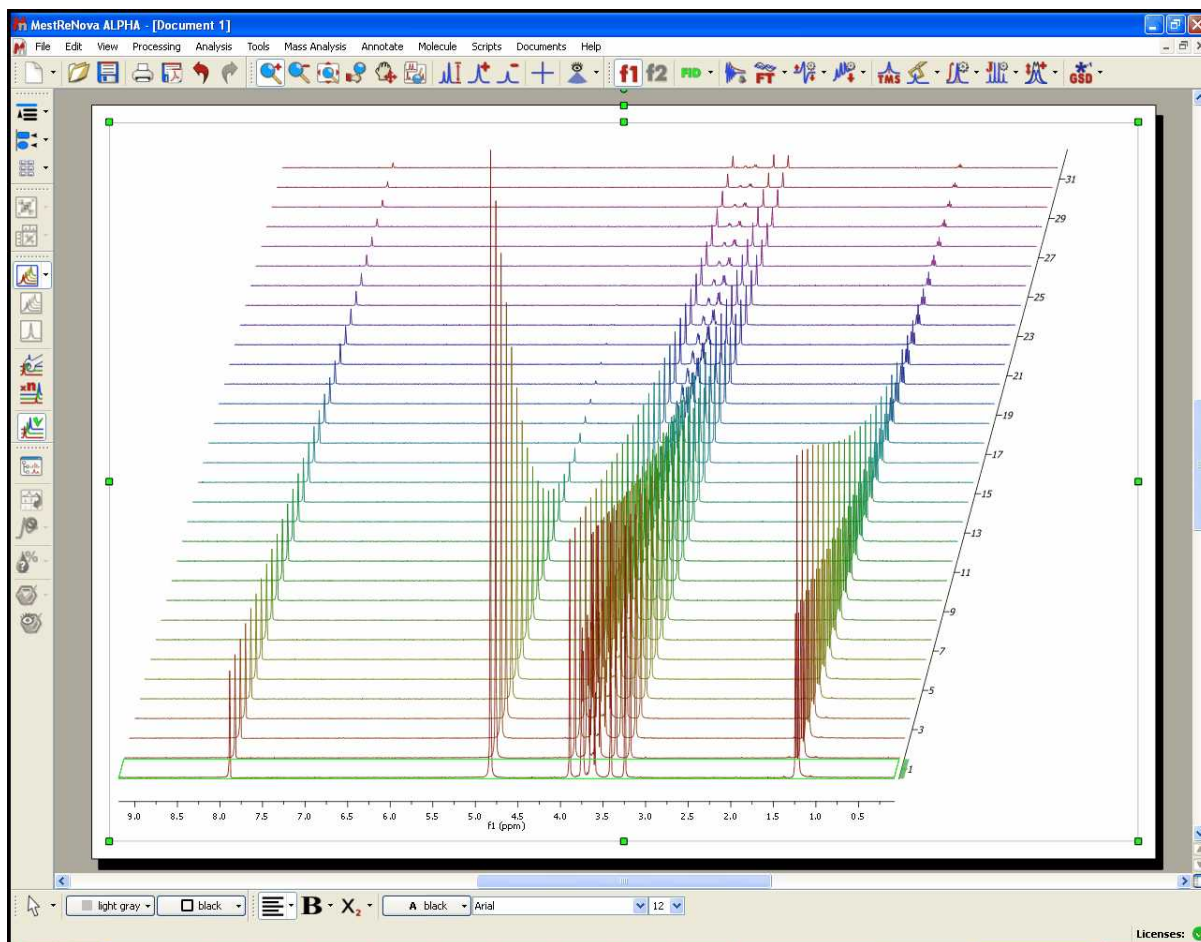

Follow the menu 'Advanced/Data Analysis/Create' and select the desired graphical representation

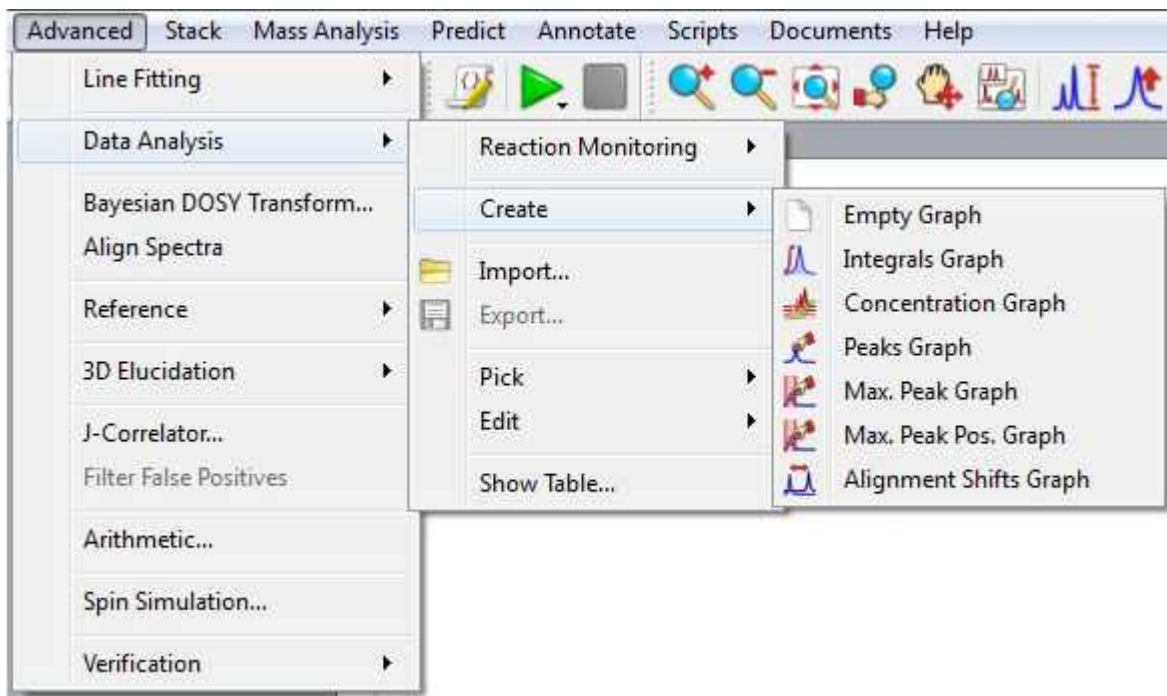

Let's select for example the 'Integrals Graph' option; you will notice how the cursor will change to a blue integral. Now you will only need to integrate the desired signal (in this case, we will select the signal at 1.20 ppm). Once you have integrate the desired region, you will notice how the graphical will change according with the decay of the signal. Please bear in mind that all values will appear in a tabulated form (in this case the integral values) and you will be able to export them to 3rd party apps

for further post-analysis or reporting (just by clicking on the 'Copy to Clipboard' button  of the table or by saving as XML files). Notice also that, if you integrate another region of the spectrum, the curve will be updated.

Go to this [chapter](#) to see a fully description of the [Data Analysis panel](#)

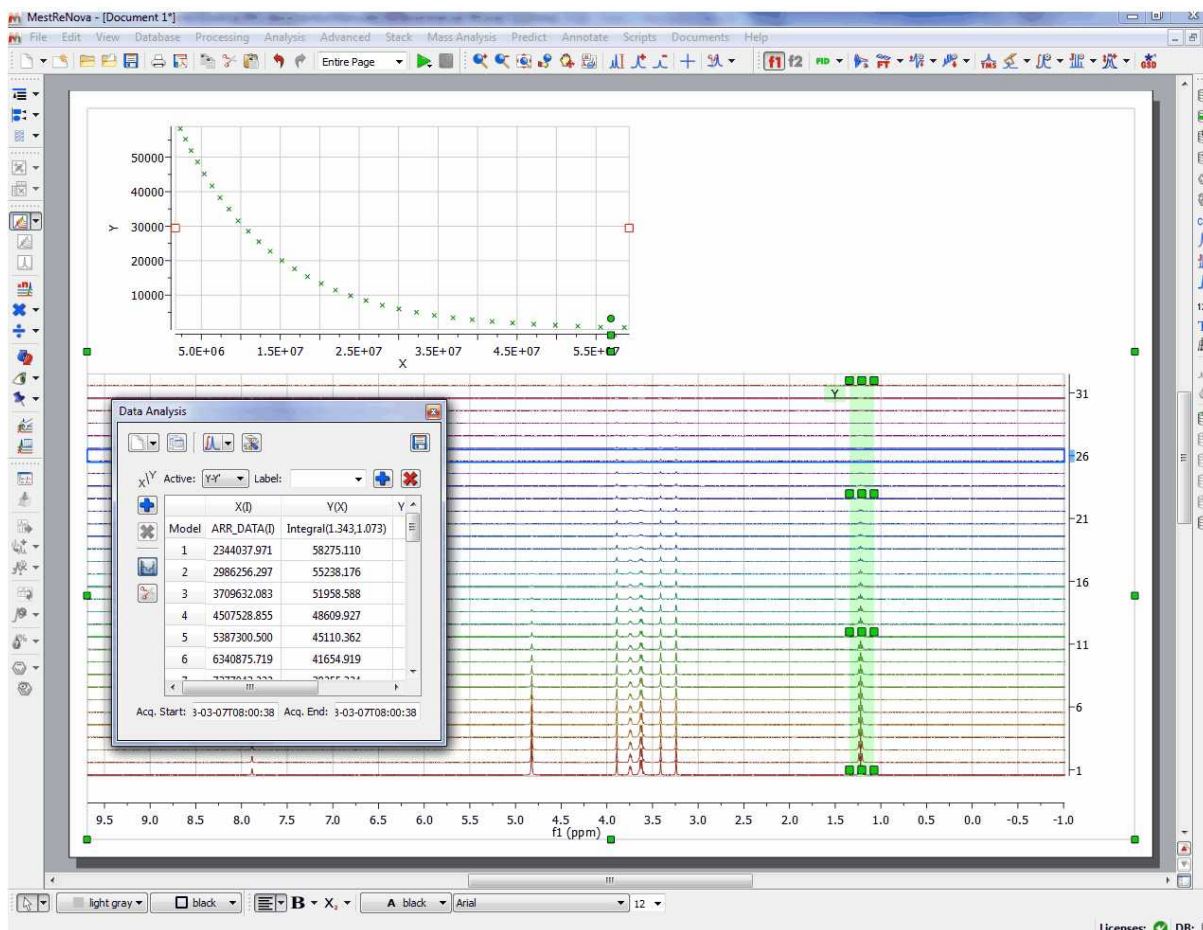

Please notice, that the integrated region will be highlighted in green and will contain several handlers to modify the ranges of the integration just by clicking&dragging them (which will be really useful for 'reaction monitoring' in order to account for peaks movements). Holding down the 'shift' key, whilst you click and drag on any of the handlers, will shift all the handlers together of the same vertical.

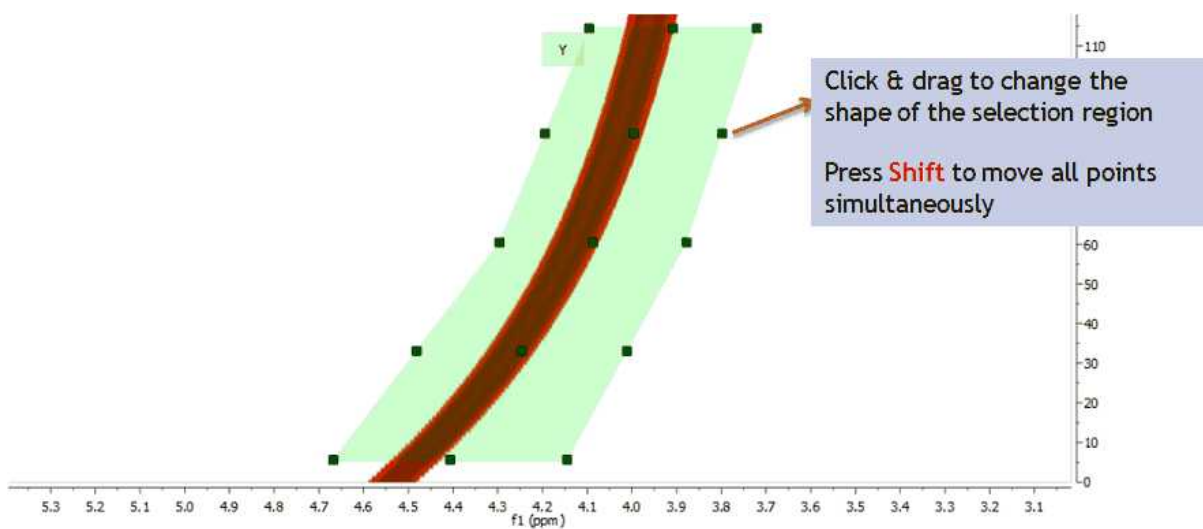

This new selection method works with any displaying mode: bitmap, stacked, active spectrum ... The

picture below shows this with the stack mode

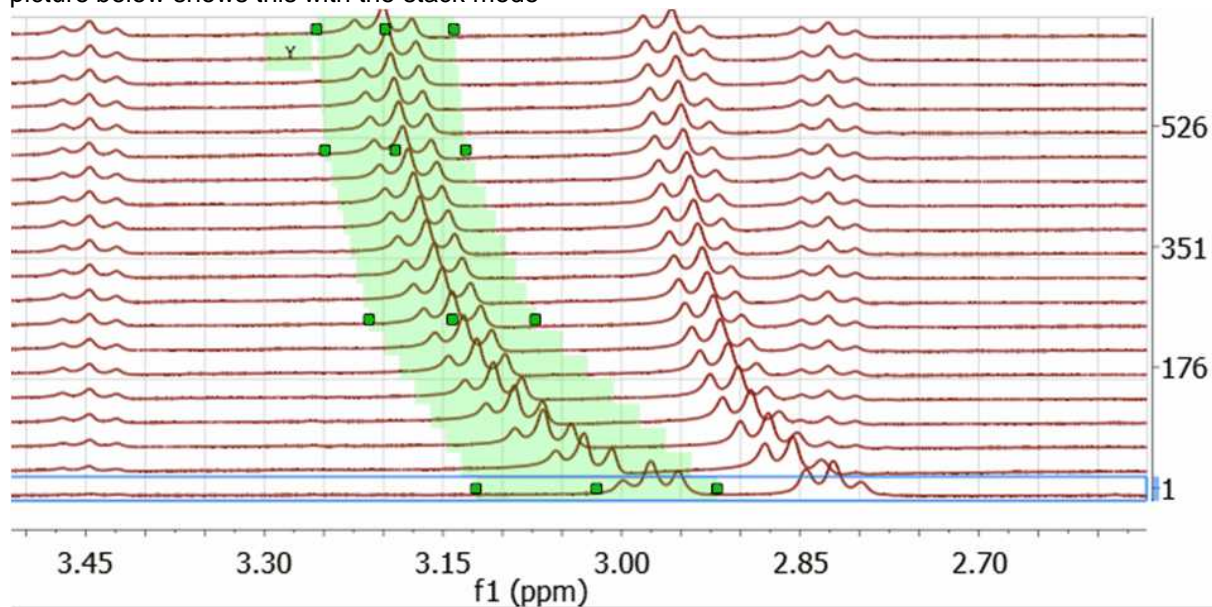

Here you can see another example, where the graphical tool can be very useful to follow the evolutions of the signals:

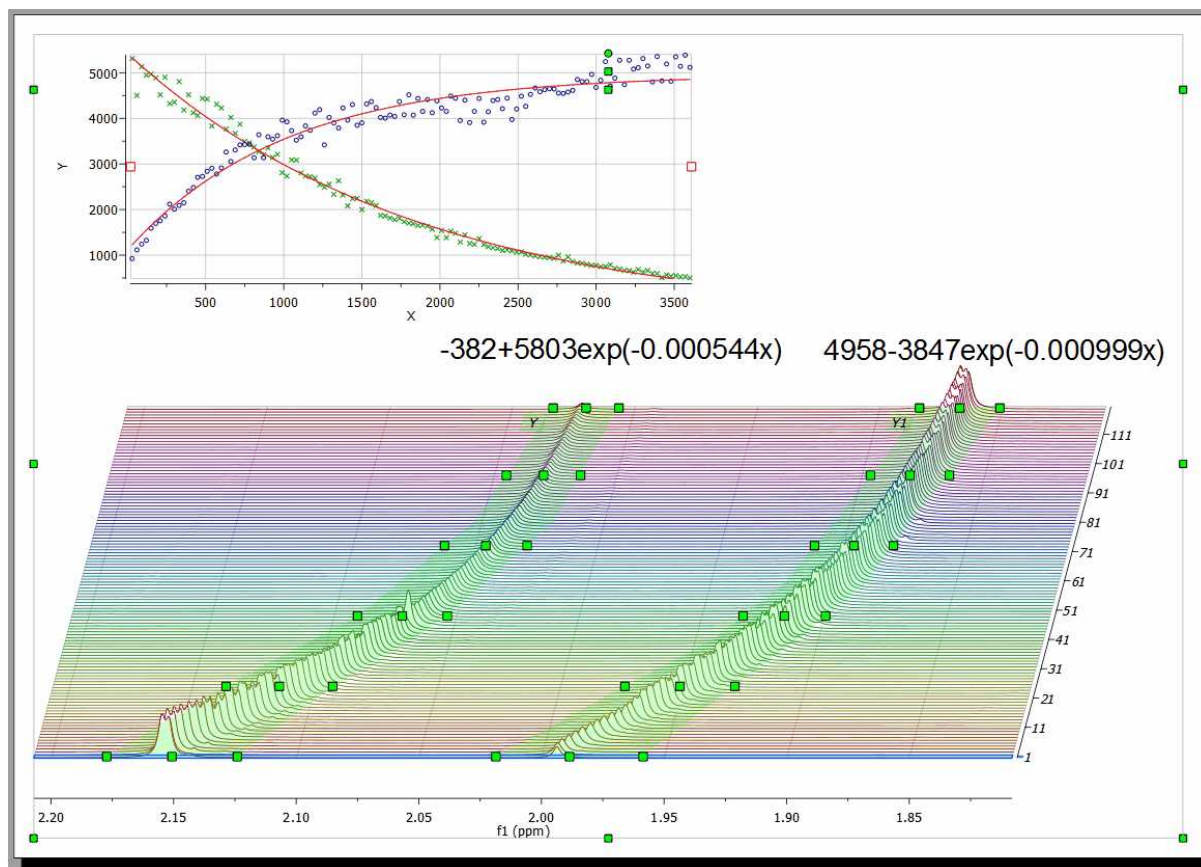

Clicking on the first cell of the column Y'(X) will allow you to fit the curve. In this case, we will fit it as a mono-exponential curve.

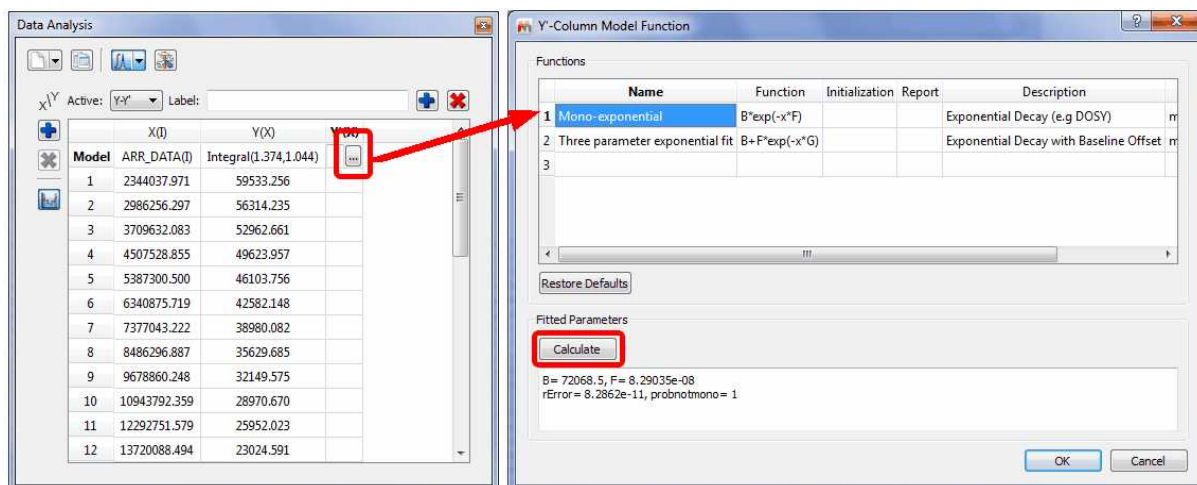

Next, click on the 'Calculate' button to generate the error and the parameters of the fitting and finally click on the OK button to draw the fitting curve.

**NOTE**

Probn ot monoparameter is very important and deserves some more information: it gives the probability (0-1) that the decay is NOT monoexponential. For example, probn ot mono >0.7 can be read as 'thi

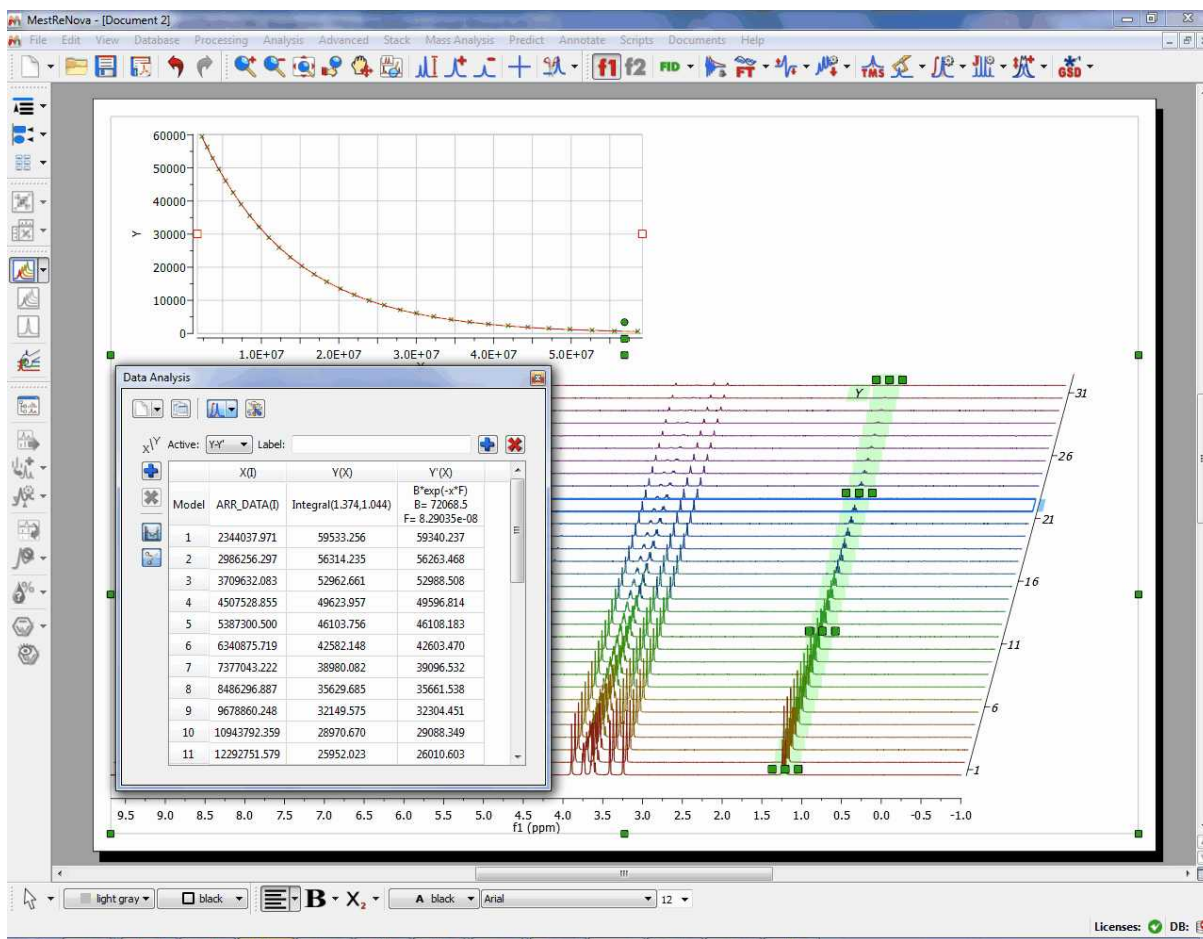

It will be also possible to allow Mnova to try to guess the order of the reaction, fitting the data to standard equations and comparing the mean square error. To do it just follow the menu 'Advanced/Data Analysis/Edit/Fit to Best'.

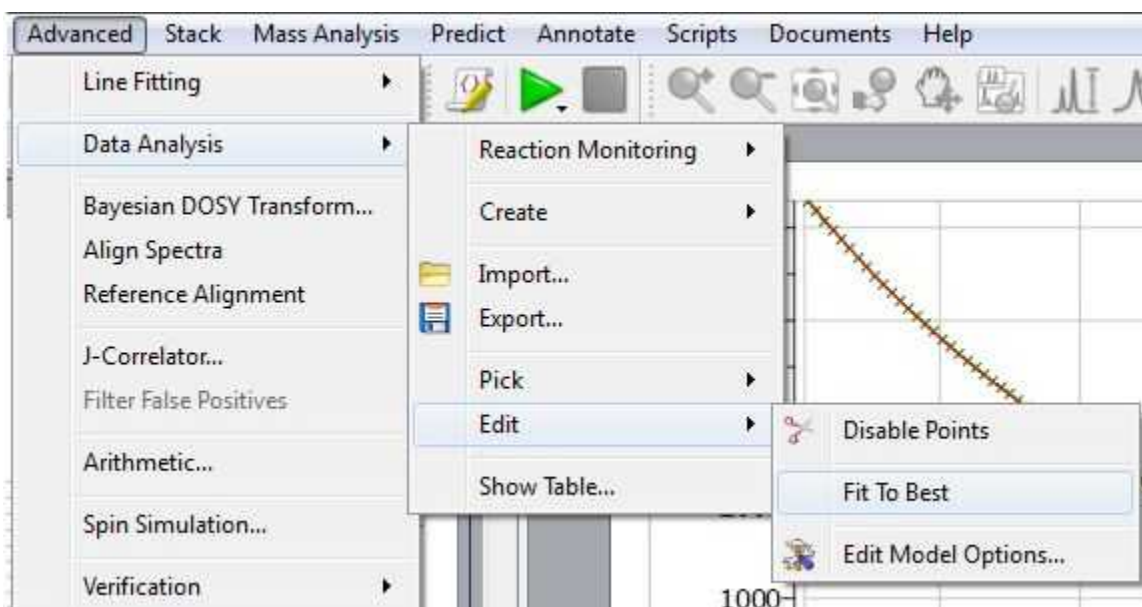

From the menu above, you will also be able to disable points (either directly from the XY graph or from the table):

The screenshot shows the 'Data Analysis' window with a table of data points. The table has columns X(T), Y(X), and Y'(X). The data points are as follows:

Model	ARR_DATA(I)	Integral(3.432,3.085)	Y'(X)
1	2344037.971	49836.629	
2	2986256.297	47734.018	
3	3709632.083	45809.814	
4	4507528.855	43953.771	
5	5387300.500	41705.769	
6	6340875.719	39105.769	
7	7377043.222	37105.769	
8	8486296.887	35105.769	
9	9678860.248	33105.769	
10	10943792.359	31105.769	
11	12292751.579	29105.769	
12	13720088.494	27105.769	
13	15218717.215	25105.769	

The context menu over the table shows the following options:

- Enabled (checked)
- Use as Time Origin
- Edit Dilution Compensation...
- Edit Pulse Width Correction...
- Integrals
- Concentration
- Peaks
- Pick Max. Peak
- Max. Peak Pos.

The context menu over the XY graph shows the following options:

- Delete Point
- Delete Point of All Series
- Use as Time Origin
- Edit Dilution Compensation...
- Edit Pulse Width Correction...
- Save to Database...
- Save to Record...
- Structure Search
- Substructure Search

This can be done either by right clicking on the point in the XY plot ...

... or directly from the table (right click on the cell and select 'enabled')

You can also disable points directly from your arrayed dataset, just by clicking on this icon  and then selecting the undesired signals on the dataset. You will notice how the applicable points in the XY graph will disappear and the signals on the stack plot will be highlighted in grey.

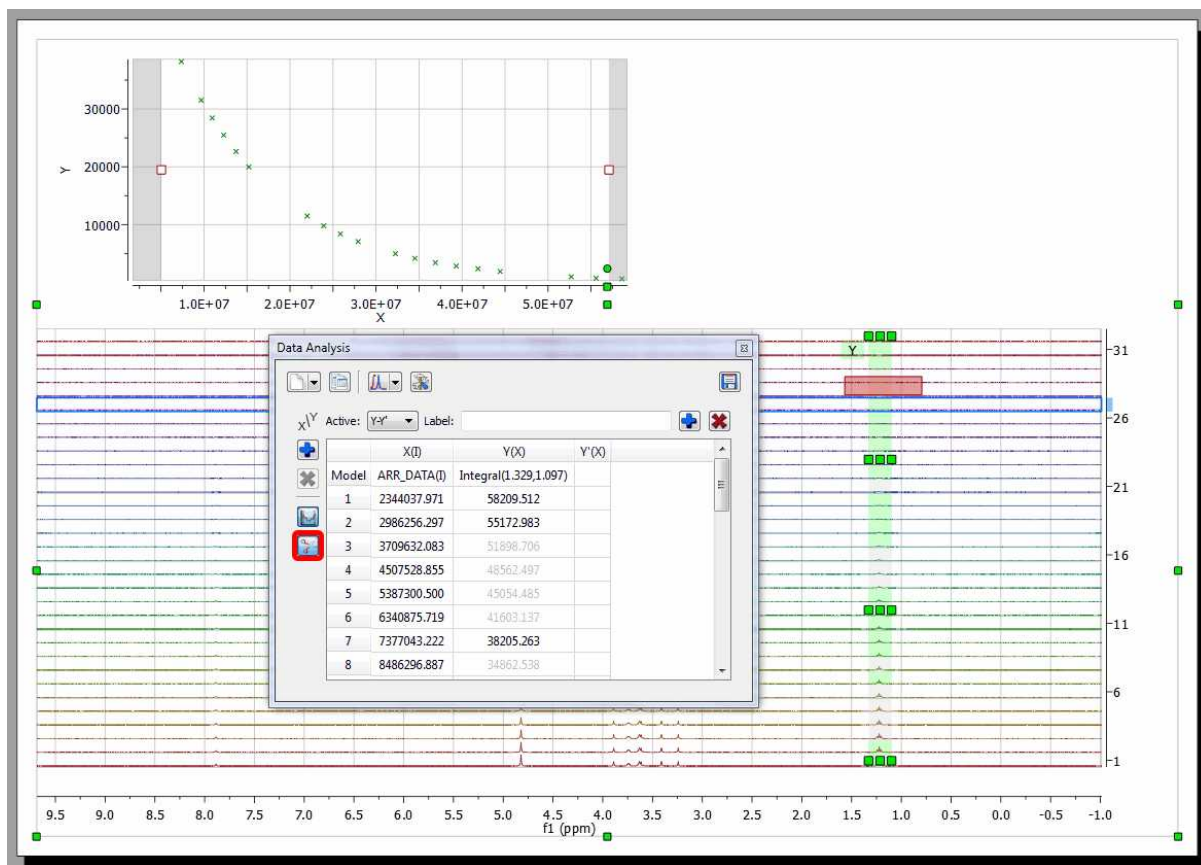

For convenience, it's possible to **exclude points from the left and right edges** of the graph:

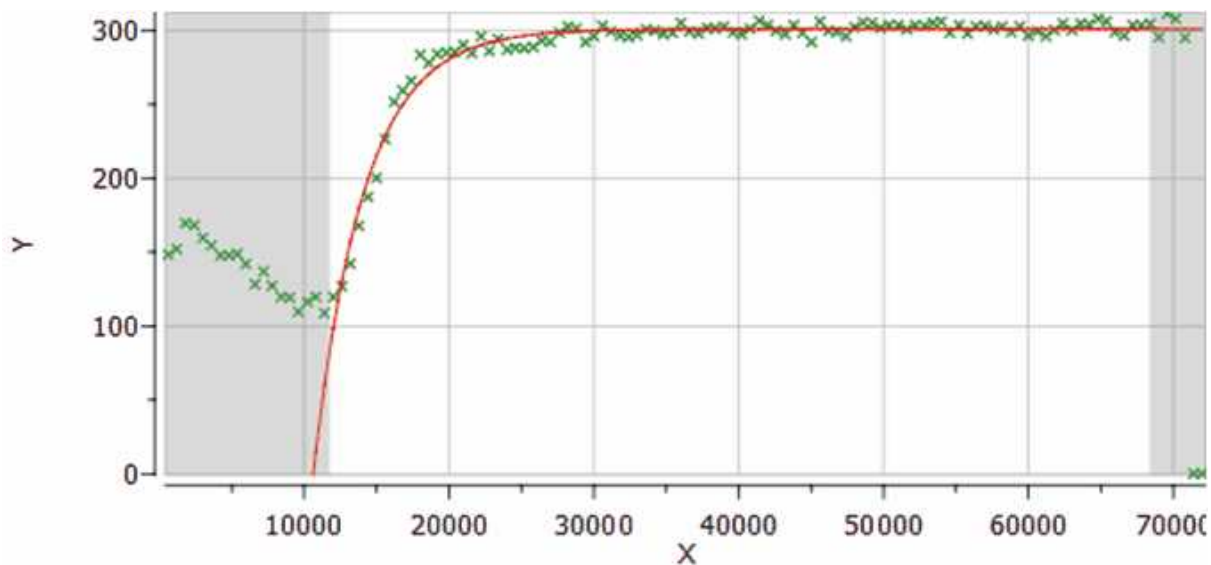

If you want to disable this option, just uncheck this button on the Data Analysis panel:

Rows	Y(X)
	Model integral(3.222,2.602
1	148.137

IMPORTANT: Every time a point is excluded, Mnova will **dynamically** recalculate the fitting function.

With the *Reaction Monitoring* plugin enabled, if you right click on any point of the Data Analysis Graph (or Table), you will be allowed to 'use that point as time origin', or to set the Dilution Compensation Parameters' and 'Pulse Width Correction':

The screenshot displays the 'Dilution Compensation' dialog box with the following settings:

- Reagent Added: NaOH
- Volume:
 - Initial Volume: 0.50 ml
 - Volume Added: 0.15 ml
- Time:
 - Start Time: 2155.0 s
 - End Time: 2185.0 s
 - Addition Rate: 0.300 ml/min

The 'Pulse Width Correction' dialog box shows the following settings:

- Start Time: 3176.00
- End Time: 3651.00
- pw90: 10.00 µs
- pw90: 15.00 µs
- Probe Retuned
- Pulse Width Factor (pw/pw90): 1.00

Please note, that it will be possible to customize your NMR model by adding any other fitting formula just by double clicking on the applicable cell and entering the desired values:

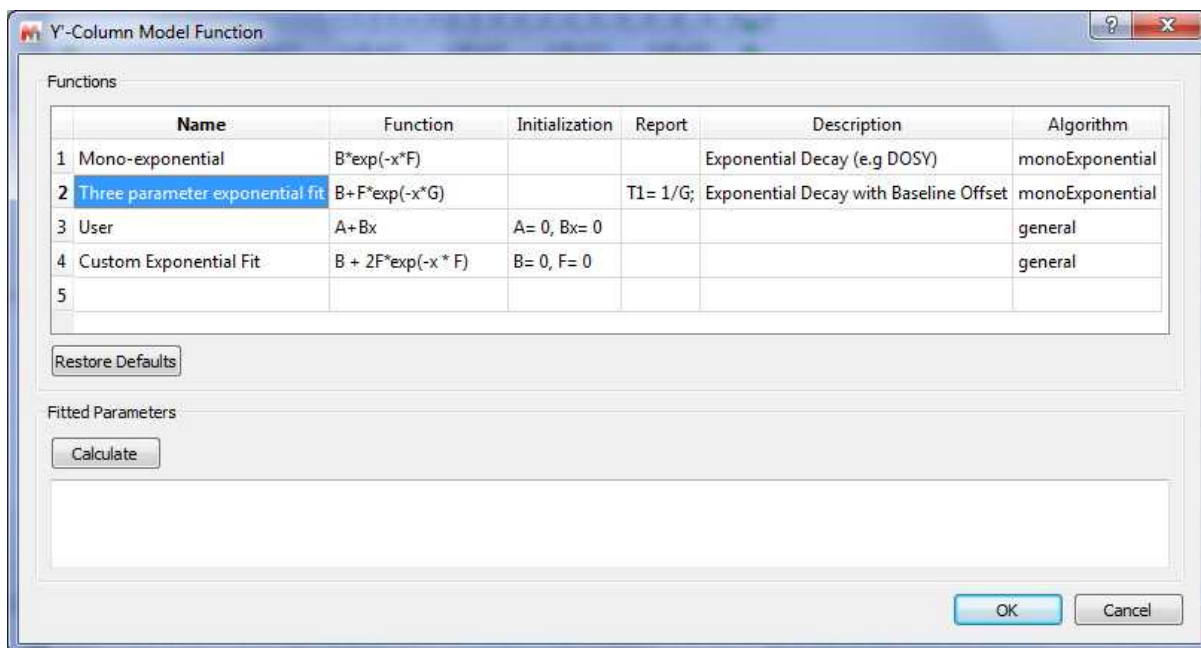

Crossing over of peaks

Crossing over of peaks is a very common event in Reaction Monitoring (RM) experiments. When this happens, the [automatic alignment algorithm](#) might not work properly. To illustrate this issue, we have simulated using Mnova a very simple data set comprised by a triplet and a singlet in such a way that the chemical shift of the triplet moves from 1.4 ppm to 0.7 ppm and having an exponential decay from spectrum to spectrum. This is depicted in the figure below, both as a stacked and a bitmap plot:

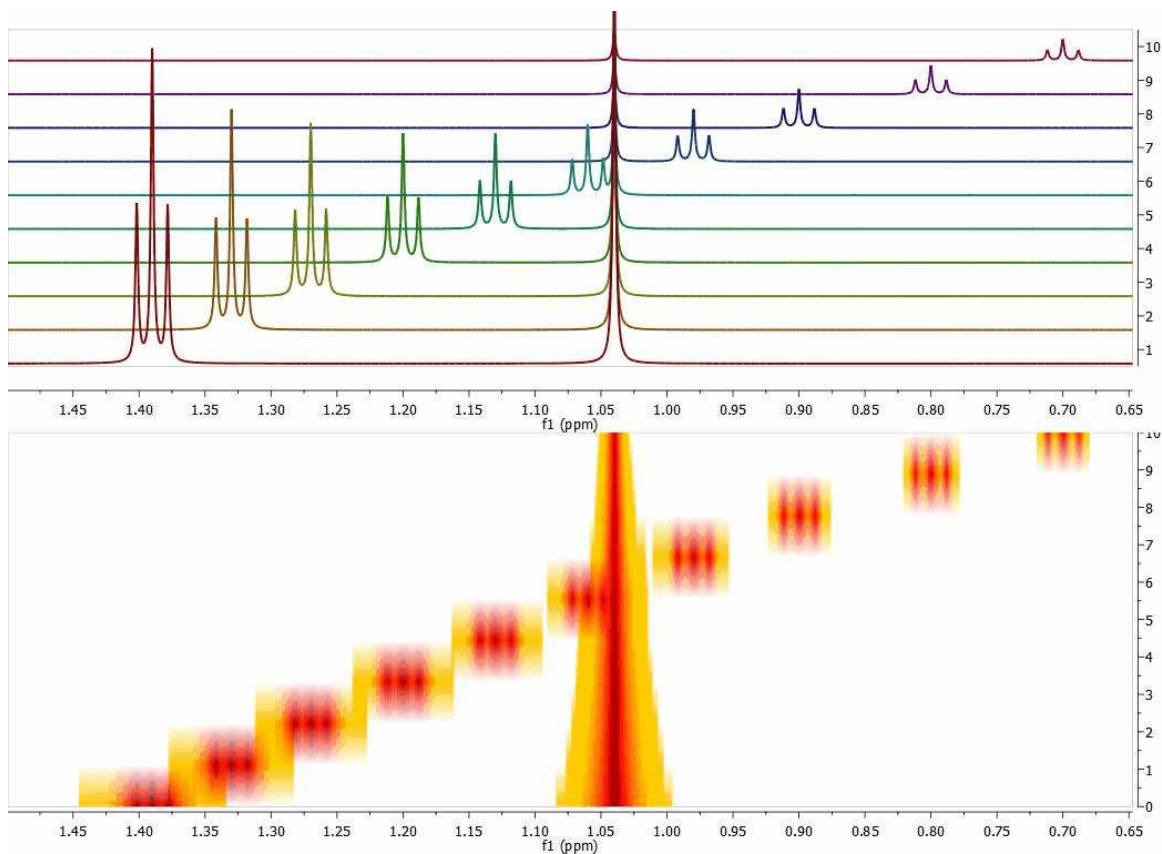

Now let's say you are interested in extracting the intensities of the triplet as the reaction progresses. There is actually no need to pre-align the spectra algorithmically; it is much simpler to have some kind of graphical tool to instruct the software which peaks (or multiplets) need to be used for the reaction monitoring analysis. Let me show you how this works in Mnova:

First of all, in the Data Analysis module you select the region to be analyzed. As a starting point, the region will have a rectangular shape (green rectangle in the figure below):

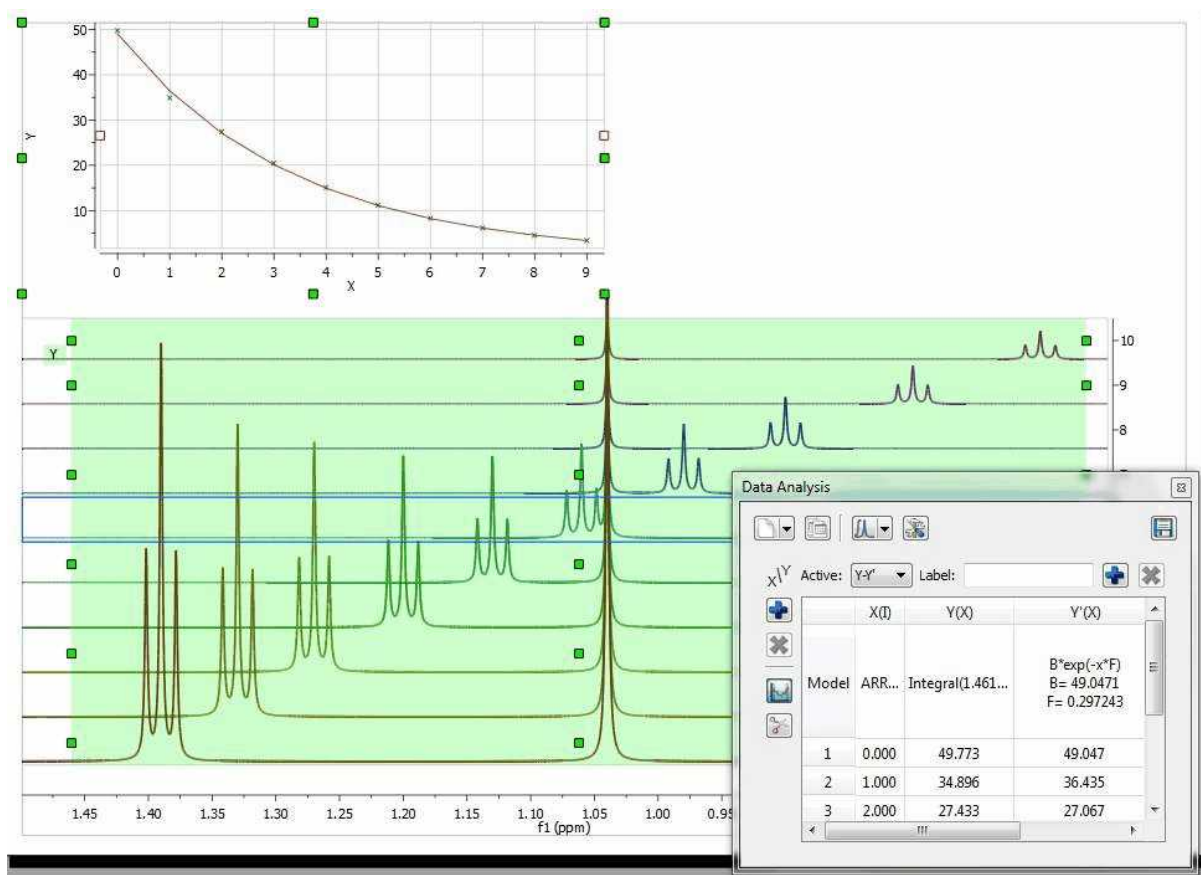

It can be noted that the graph shows an exponential decay, but the actual values must obviously be wrong as the values calculated, using the green rectangle as a boundary for the integration, include peaks from both the triplet and singlet, and we are interested in the analysis of the triplet resonances only.

The selection rectangle has a number of handlers (small green boxes). You can drag and move them freely so that you can adjust the selection feature to follow the triplet (the number of handlers can be adjusted in the Data Analysis options). In the figure below, the result of adjusting the handlers to follow the triplet is shown:

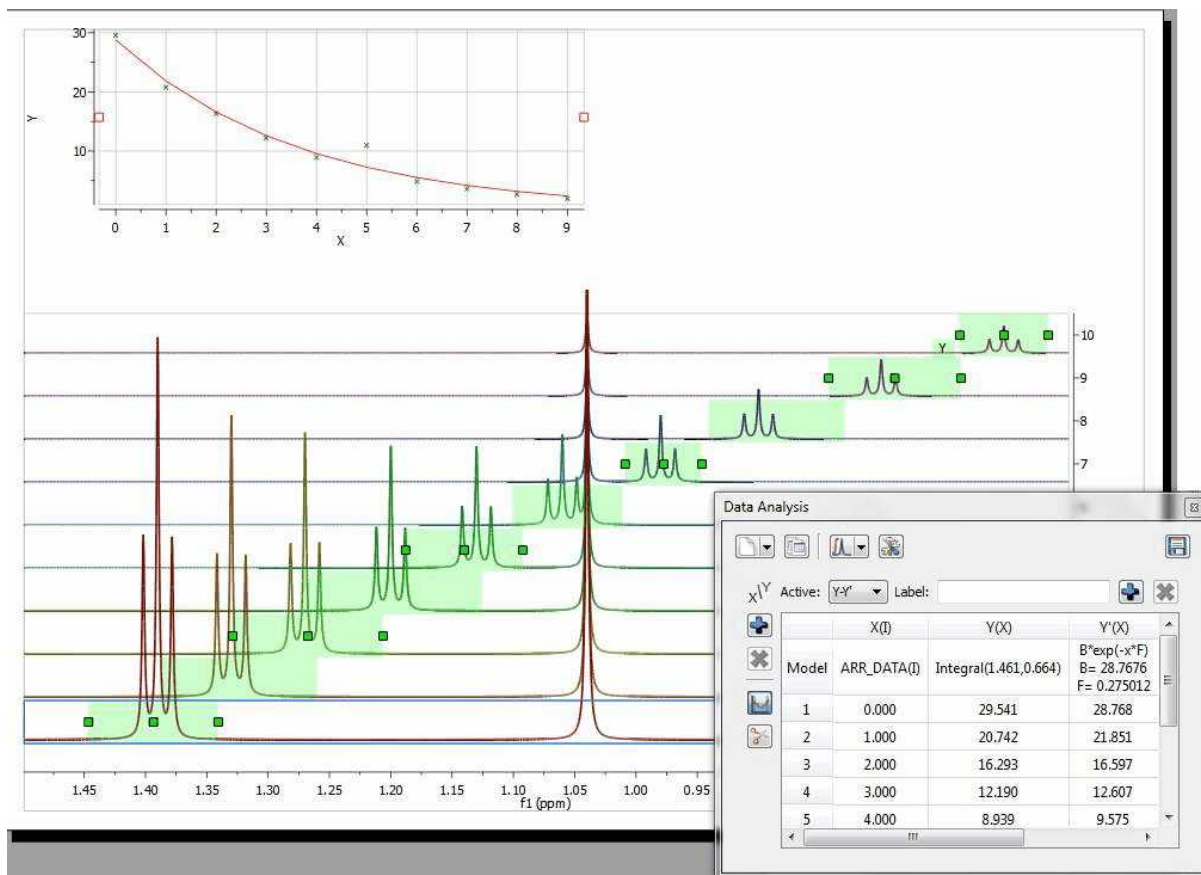

Now you can see that there is an outlier in the exponential curve which, obviously is caused by the singlet which overlaps with the triplet (spectrum number 6 which corresponds to data point #5, as in the graph the numbering starts from zero). Figure below shows that particular spectrum showing the singlet overlapping with the triplet:

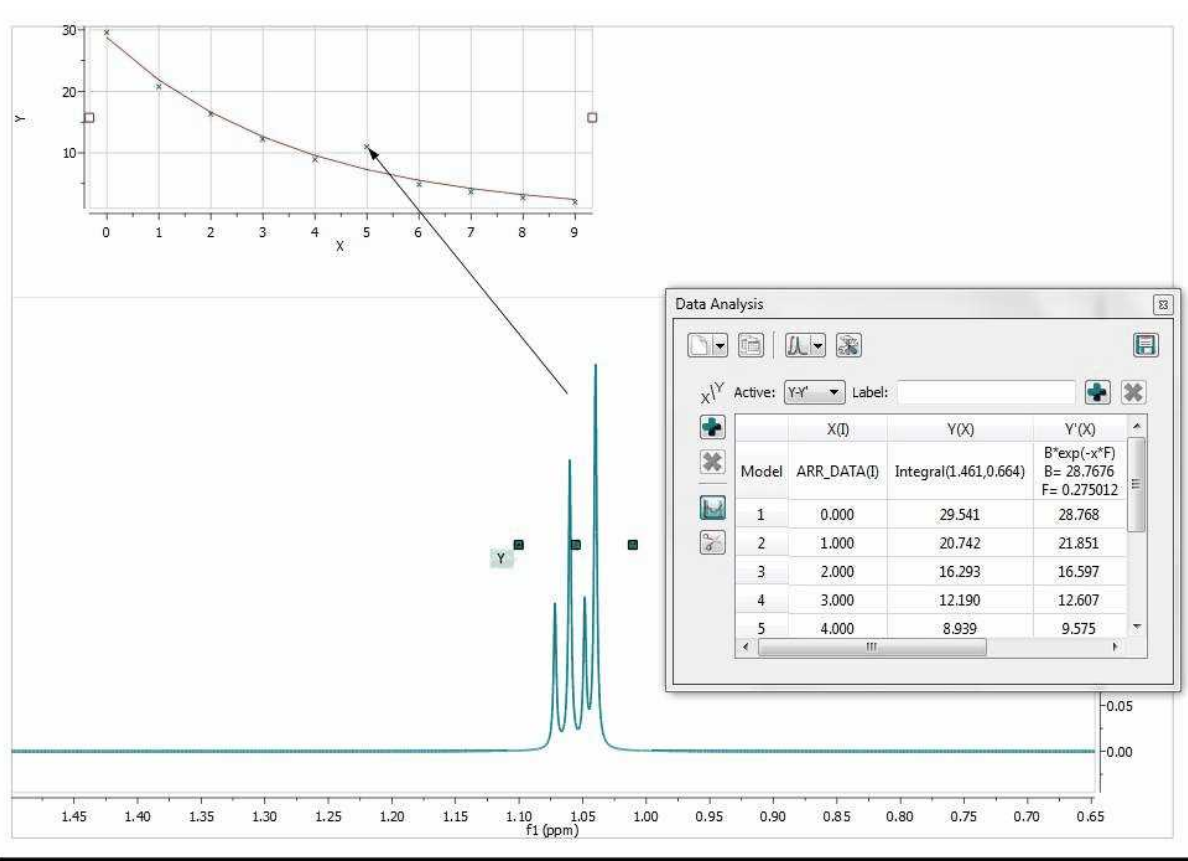

At this stage, there are several approaches. The simplest one is to just discard that point for the analysis, for example, by right clicking on that point in the graph and disabling it:

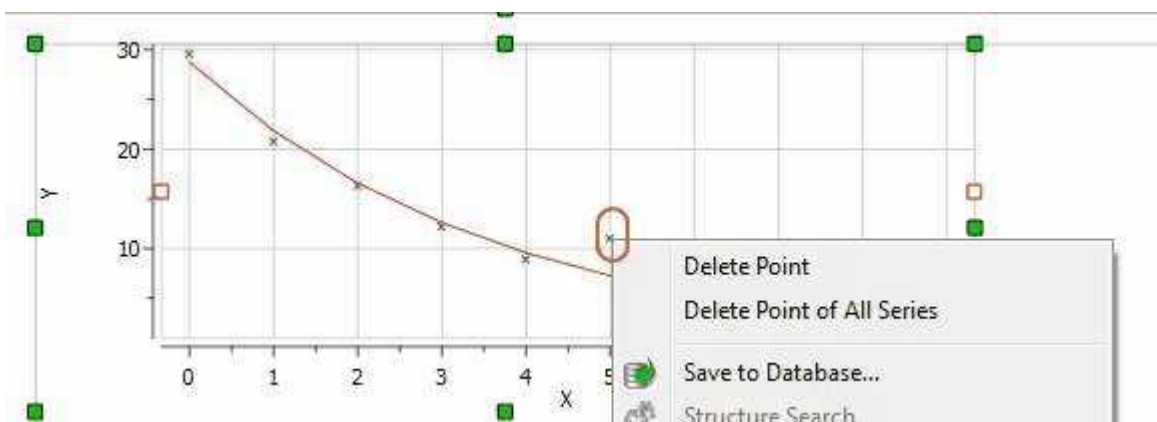

As soon as that point is deleted / disabled, Mnova will update the graph automatically. This is the new result:

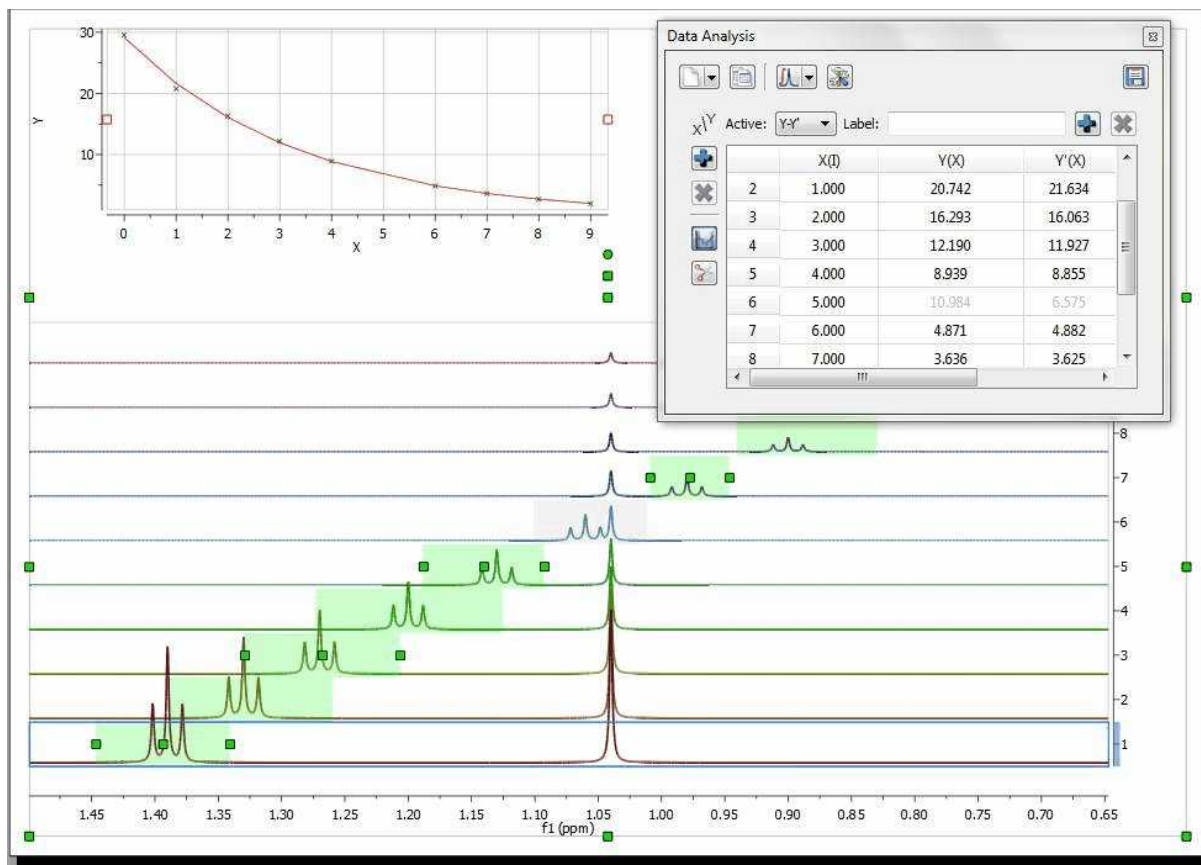

Another approach would involve using GSD to eliminate the singlet from the triplet so that it would not be necessary to discard the information from that particular spectrum.

10.3.2 Data Analysis panel

The Data Analysis panel contains several options to create your graphs. You can import a .txt or .csv file (via File/Open dialog) to fill the Data Analysis panel with X,Y values and generate the applicable graphical representation.

It will be also possible to select any graph from the scroll down menu below and then a region of interest in the arrayed spectrum:

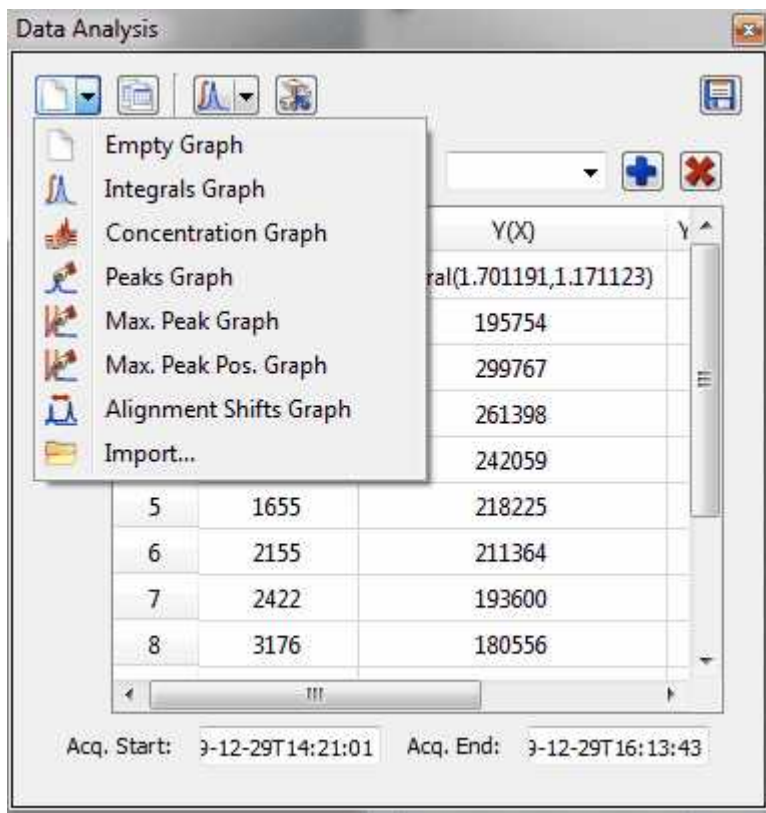

If you select the Concentration Graph, a new dialog box will appear to ask you for the number of nuclides of the selected region

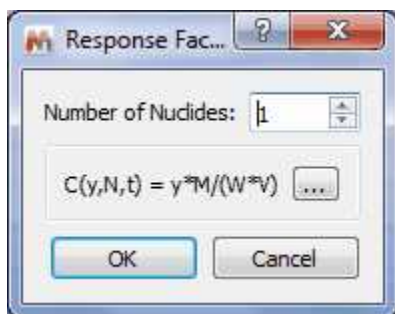

Clicking on the 3 dots button, it will be possible to customize the formula:

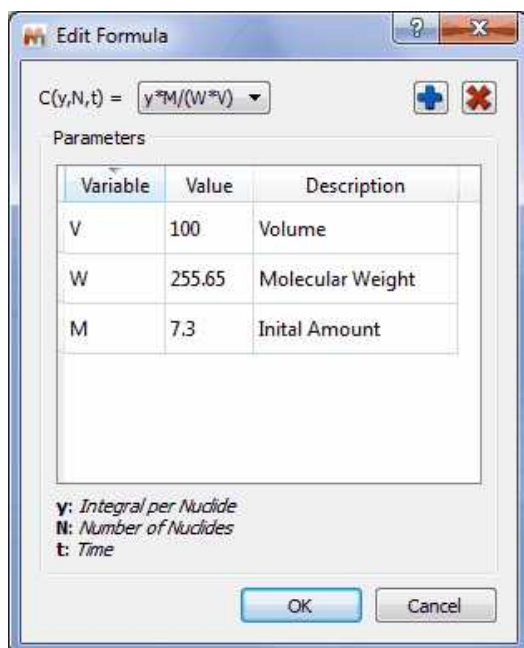

The terms in the equation and table are as follows:
 N=Number of nuclides
 W = molecular weight of chemical species (g/mole)
 M = initial amount, or mass
 V = volume

So if M is in grams, and V is in litres, then the equation calculates concentration in Molar. (Obviously the user can introduce factors to convert this to mM or whatever is convenient).

With the '*Reaction Monitoring*' plugin enabled you will be able to select 'PULCON' or 'Initial Concentration' modes:

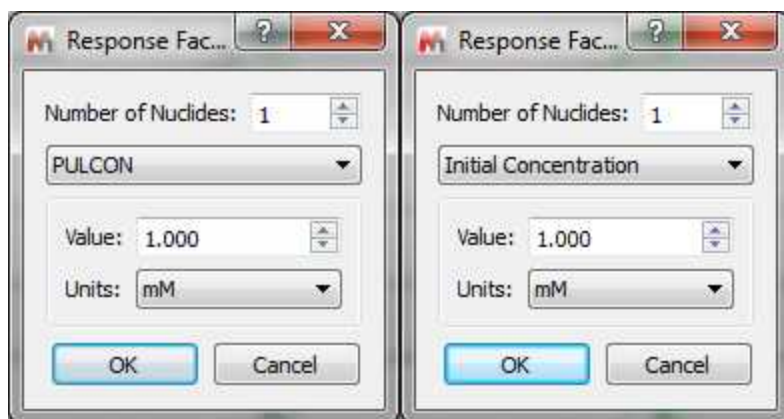

NOTE: If the X column in Data Analysis is filled with zeros or you need to change the function, just double click on the model cell to derive t' not only from t but also from i-spectrum index:

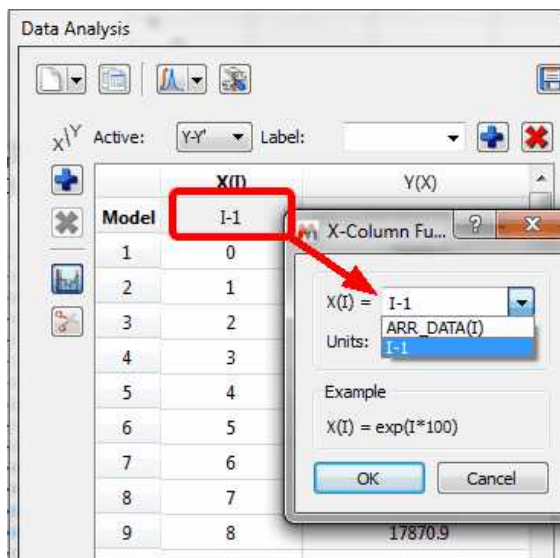

Clicking on the 'Interactive Y Filling' scroll down menu will allow you to select between different peaks selection modes (Peak Integrals, Concentrations, Intensities, or Maximum Peak Intensity, Alignment shifts or import YY' File), in order to generate the applicable plot.

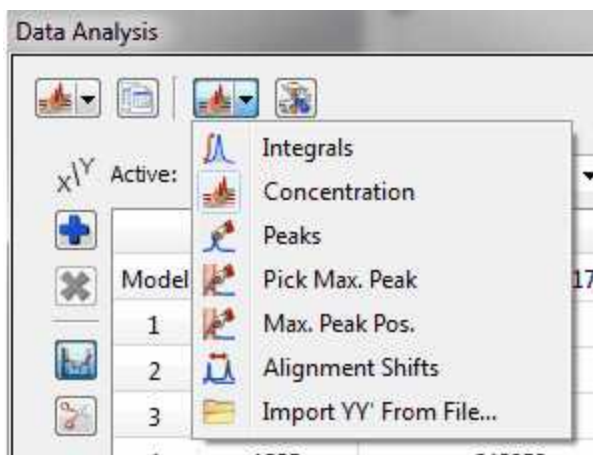

Please note that you can also change those options by double clicking on the '...' button of the Model cell under the Y(X) header of the Data Analysis panel:



The 'Alignment shift' option will measure the change of chemical shift of the peak across the spectra, after having used the Alignment algorithm to align the peaks of interest.

It will be also possible to add additional curves to the representation, just by clicking on the 'Add New Data Serie' icon  (of the 'Data Analysis' dialog box) and integrating (or applying the Pick Peaking analysis) the desired region of the spectrum. Let's add the integration of the signals at about 7.9 ppm (a new curve will be drawn with blue circles in the representation):

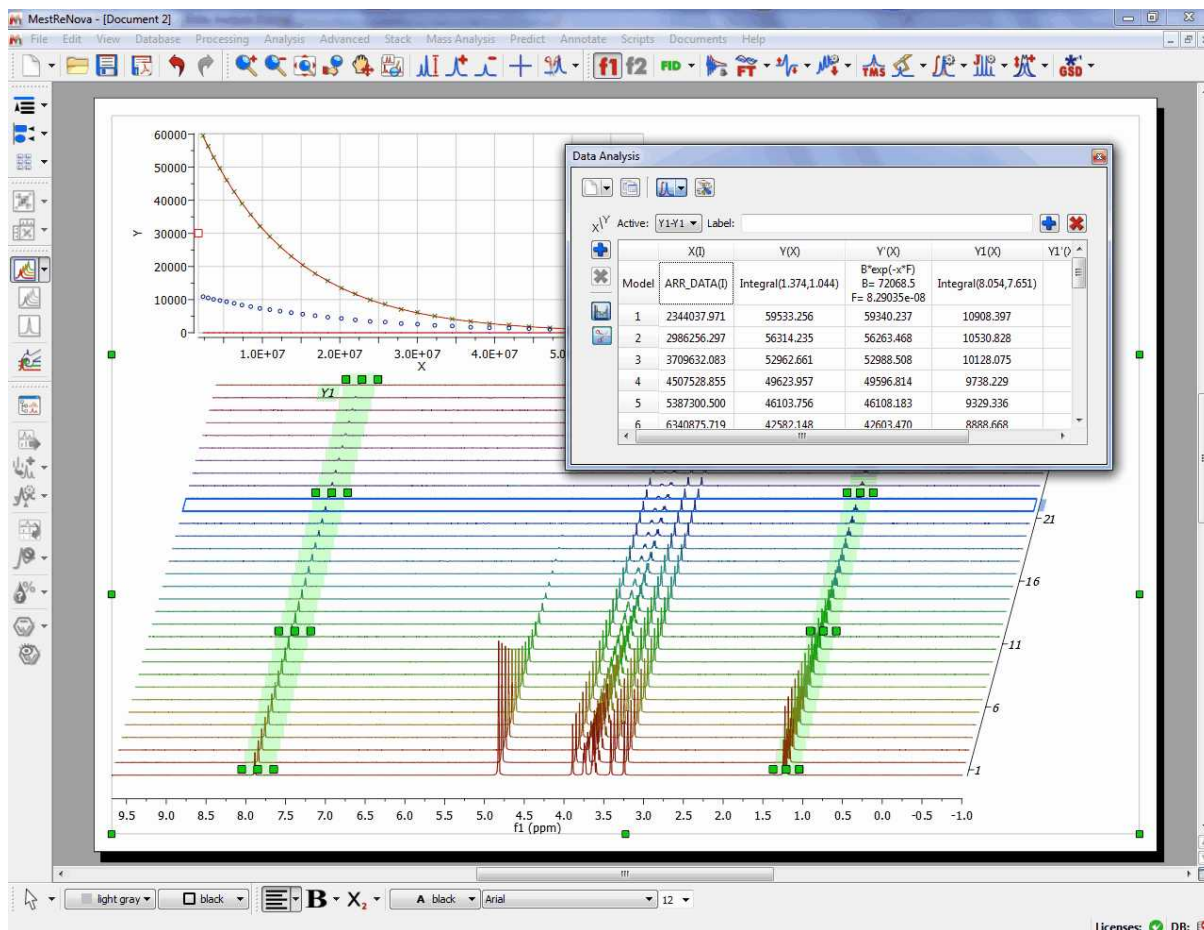

Clicking on the 'Options' button, will allow you to change some defaults, such as the capability to replace the active column (or to create a new one); number of handlers of the selected regions, the Fit function for the Y'-Filling column or use a 'Parabolic Interpolation for the 'Peak intensities'.

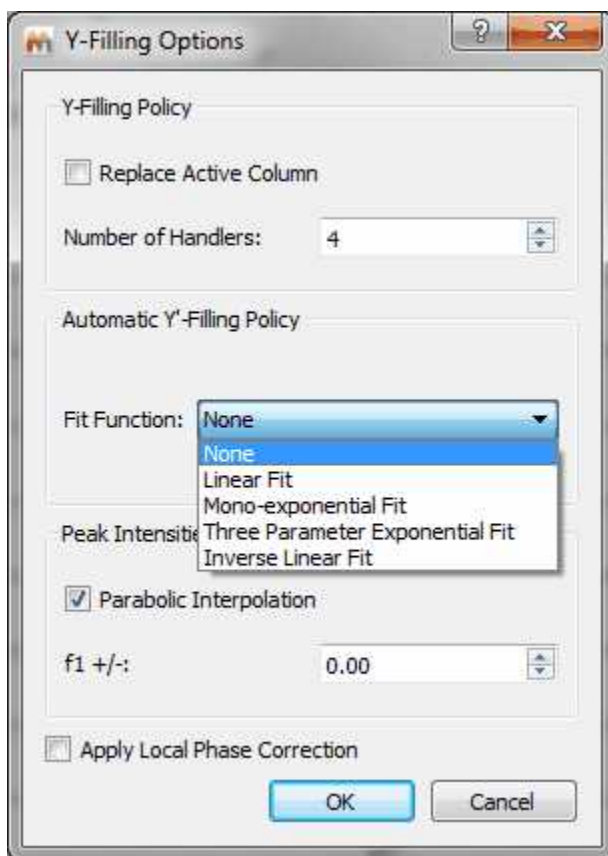

- It is possible to export the graphical dataset to an ASCII file just by selecting the 'Data Analysis graphic' and following the menu 'File/Save as/ASCII Text File (*.txt).
- Rows corresponding to spectra which have been removed from the dataset will be marked with **red** color in the Data Analysis table.

Right clicking on the Data Analysis Graphic, will allow you to update the graph after having made changes in the Stacked Spectra Table or directly on the stacked spectra (very useful, for example if you invert the order of the spectra). If you have more than one curve, you will be able to select/deselect available "series" (curves) on the plot.

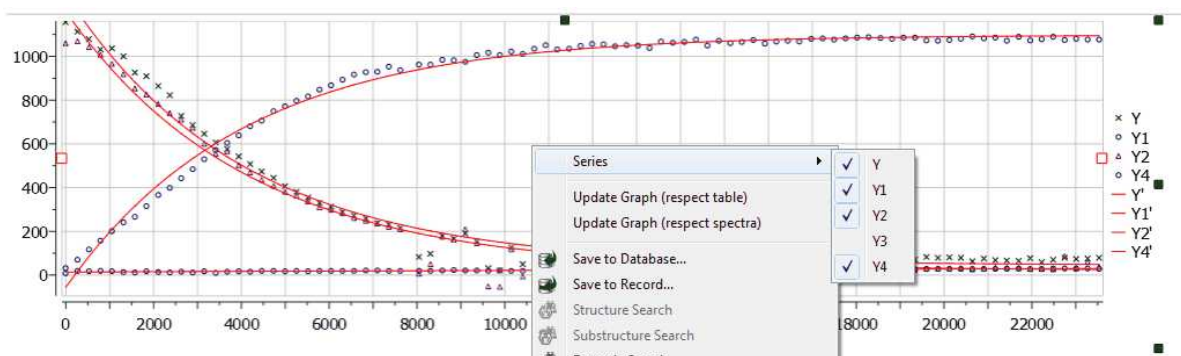

It will be possible to add [blind regions](#) to your arrayed experiment, just by following the menu 'Processing/Blind Regions/Add Blind Regions'

10.3.3 Reaction Monitoring (R-M)

Right now, this plugin is on **limited release**. If you want to try it, please email us to support@mestrelab.com

You will need to install the RM plugin apart, by following the menu 'Edit/Advanced Plugins' and clicking on the 'blue plus' button.

Many experiments require obtaining a series of FIDs, related to each other through the variation of one or more parameters.

For example, in a kinetics or reaction monitoring (R-M) experiment, a series of spectra are recorded at predetermined time intervals to follow the progress of the reaction.

There are two ways to acquire these kind of experiments:

- Acquiring all spectra at different times and storing those individual spectra
- Instead of acquiring separate data sets, it is very common to keep all acquired spectra into a single NMR experiment, the so-called **Arrayed mode**

In general, arrayed mode is the most commonly used, although sometimes, acquiring the spectra as individual spectra can offer more flexibility. Of course, **Mnova supports both modes**.

10.3.3.1 Importing Datasets

Importing of R-M data sets acquired on individual basis

Mnova includes a powerful script which makes it possible to import all spectra contained in a folder and automatically stack them for forthcoming R-M analysis. This script is under the Scripts menu and it is called 'Directory Spectra Stack'. It will allow the user to select the directory where the spectra are contained. Then Mnova will open and process all those spectra (FIDs) automatically in bunches of 20 spectra and finally will stack all of them.

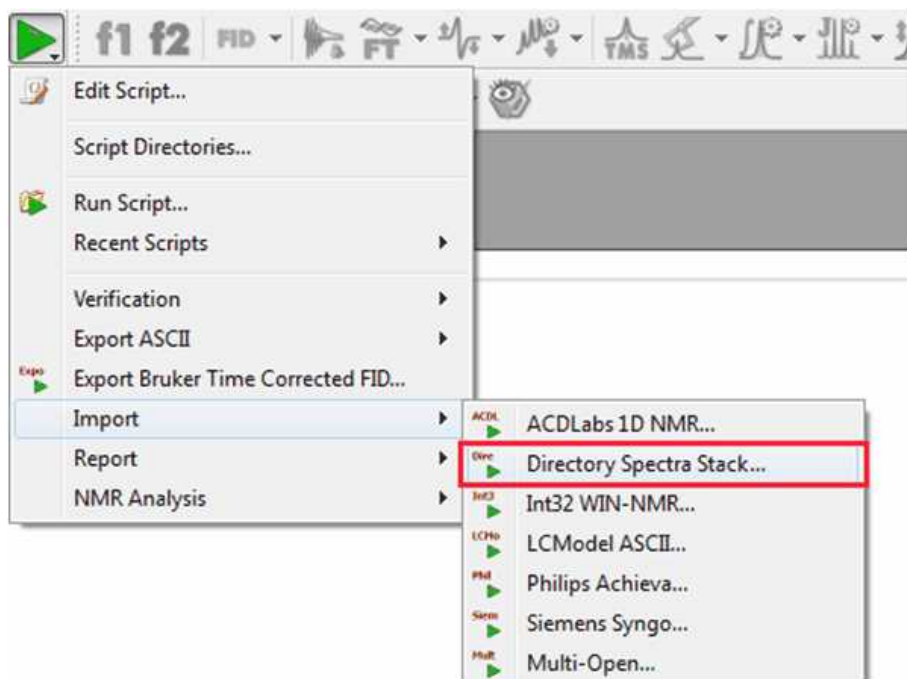

Note: This script has also the option to decimate the spectra while loading (i.e. the program can skip every 10 spectra in the data set) and to apply a processing template (or to load the 1r processed data):

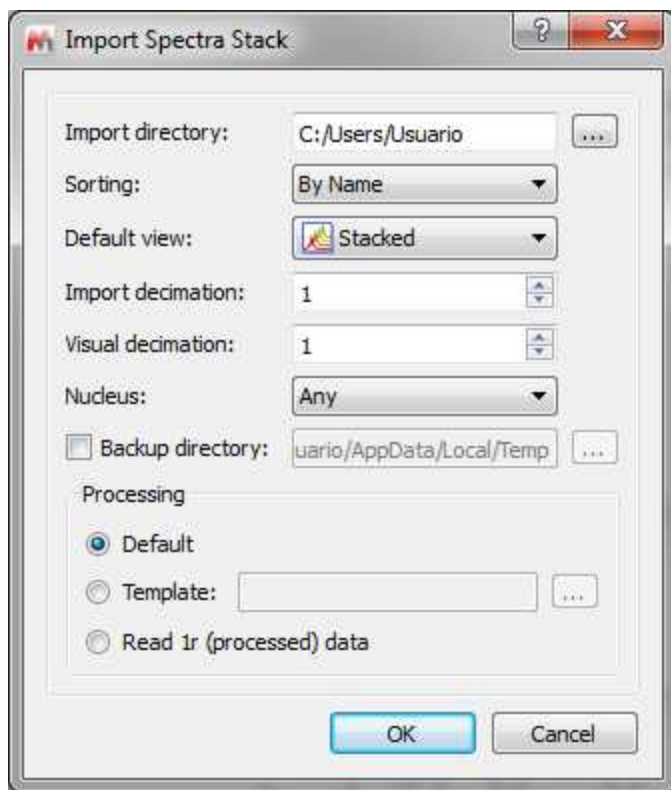

With the Reaction Monitoring plugin enabled, you will be also able to import your datasets by following

the menu 'Advance/Reaction Monitoring/Import RM Dataset':

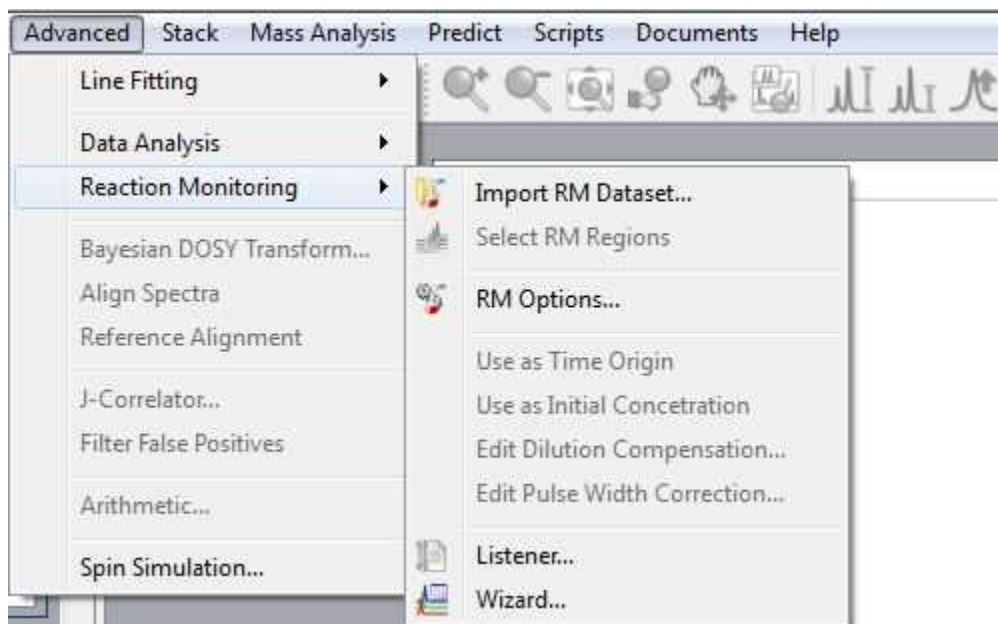

Or by using the applicable button  of the RM toolbar:



This toolbar contains and also a button to open a wizard and a listener.

Reaction Monitoring Wizard  :

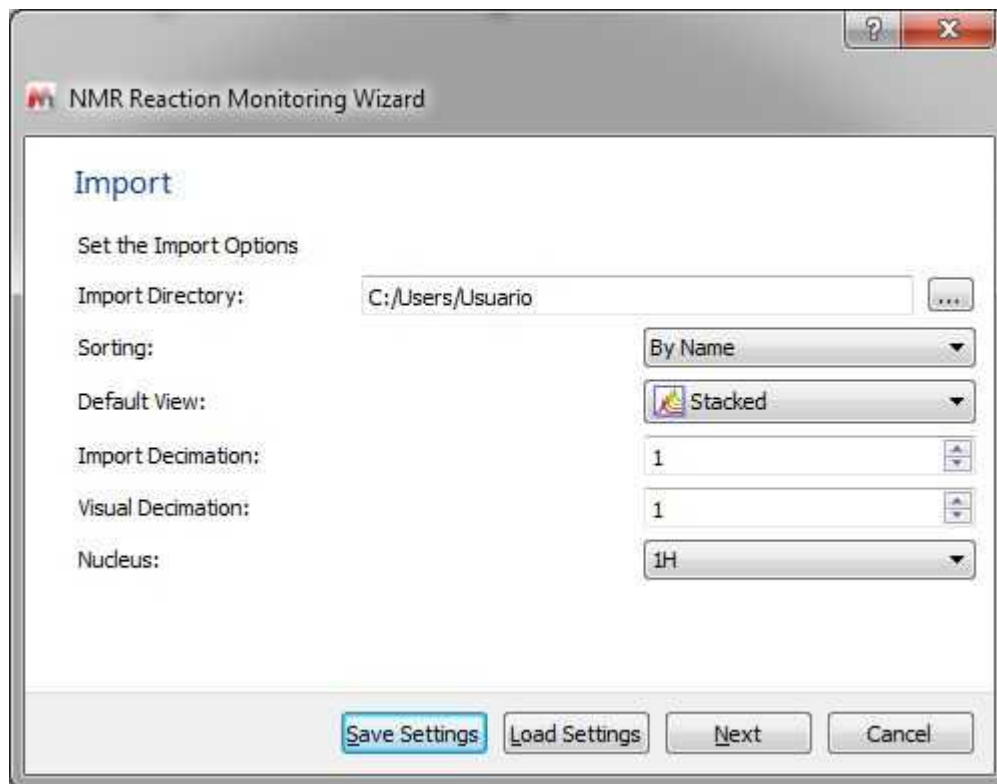

This wizard will allow you to select the directory of your dataset, to sort them by name or date, to display them in stack or superimposed mode and to use decimation. You can also 'Save or Load Settings' from this dialog box. Clicking on the 'Next' button will display the dialog below:

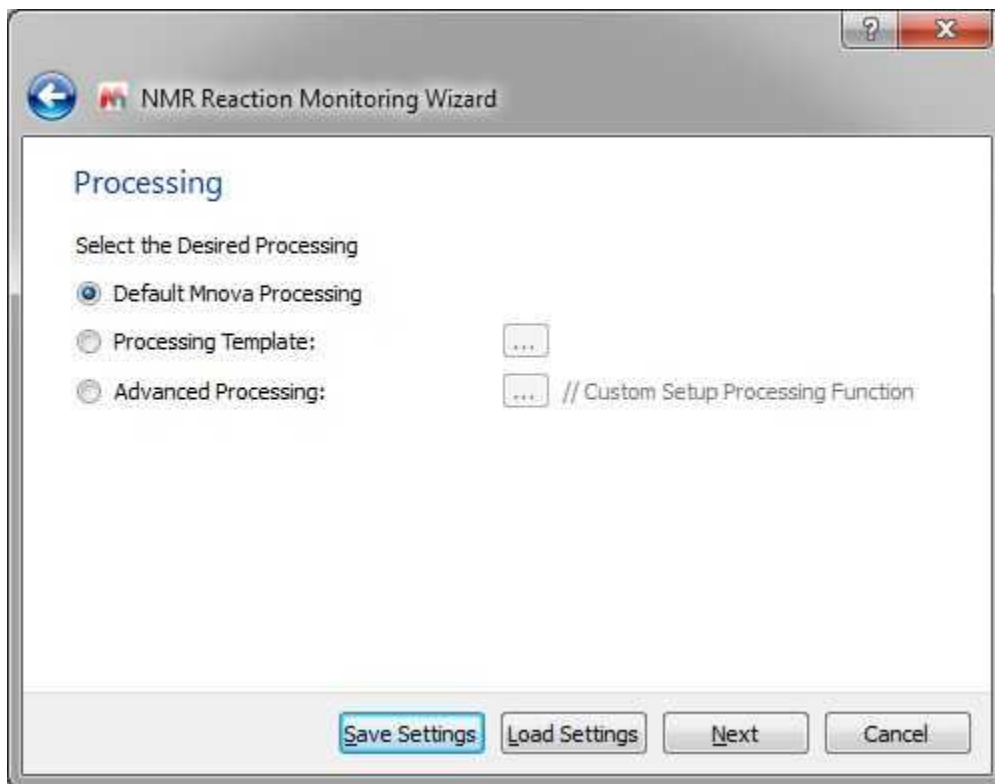

This new window will allow you to apply [processing templates](#) to your datasets. Clicking on the 'Next' button will display the 'Extraction' dialog:

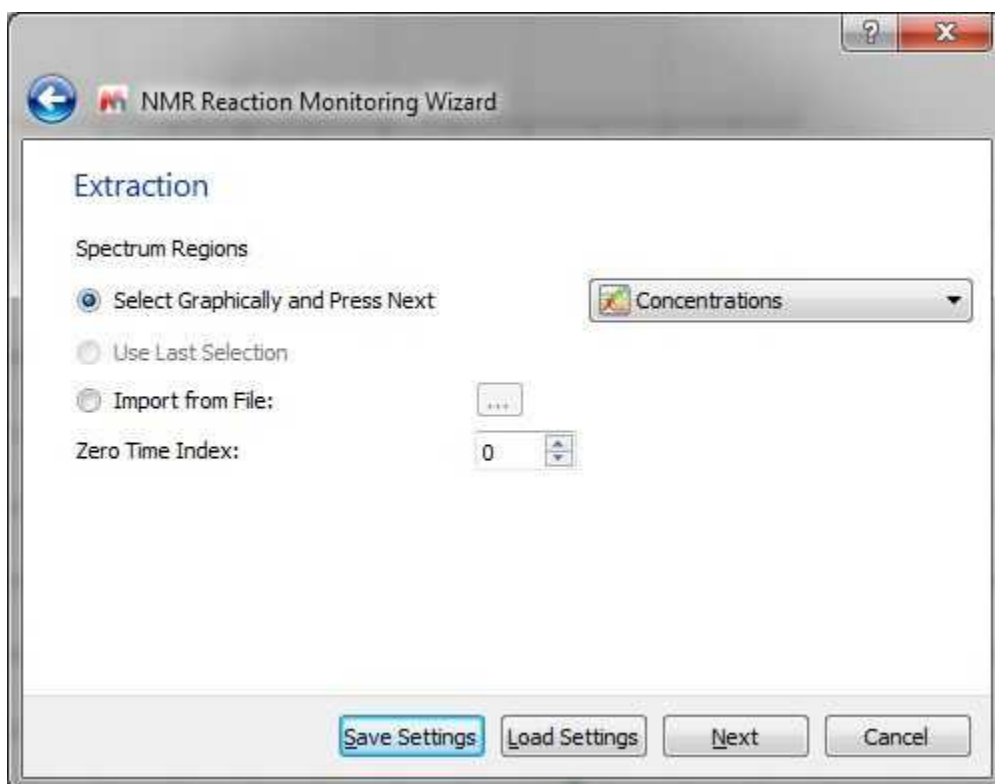

From the dialog above, you will be able to select graphically the regions (with concentrations or integrals), import a XML file with the regions of interest or use the latest selection. From here you can also select the Zero Time Index. Clicking on the 'Next' button will display the 'Fit Options' dialog:

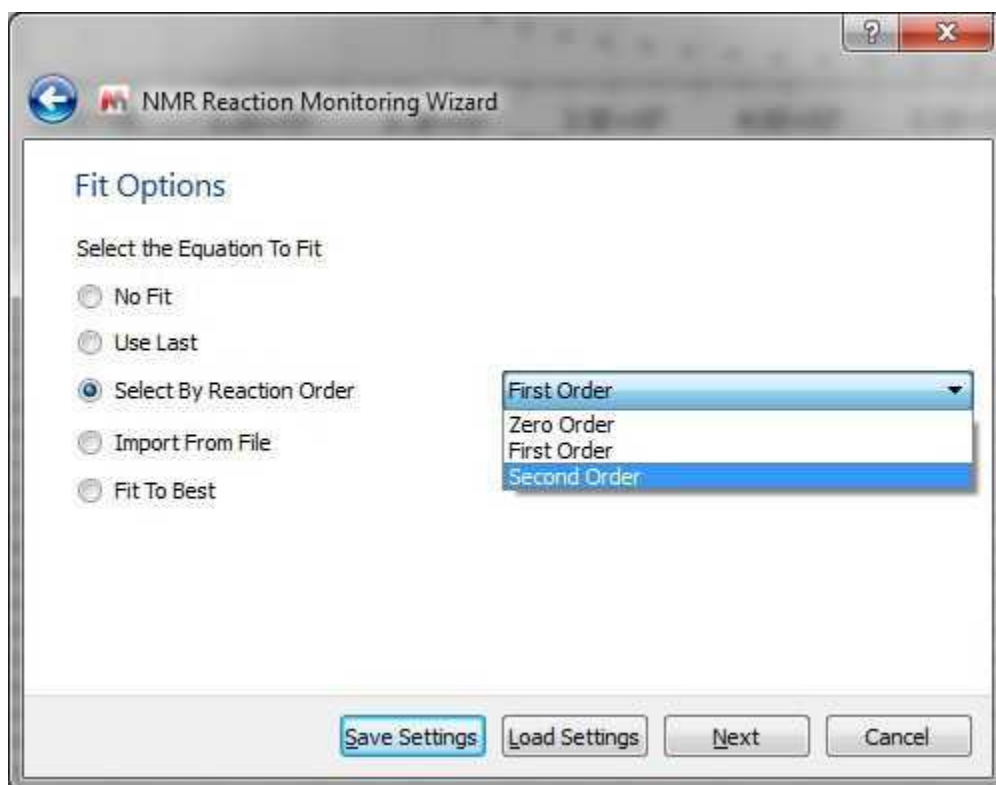

Finally, click on the Next button to display the Report dialog box which will allow you to save the document in Mnova or PDF format:

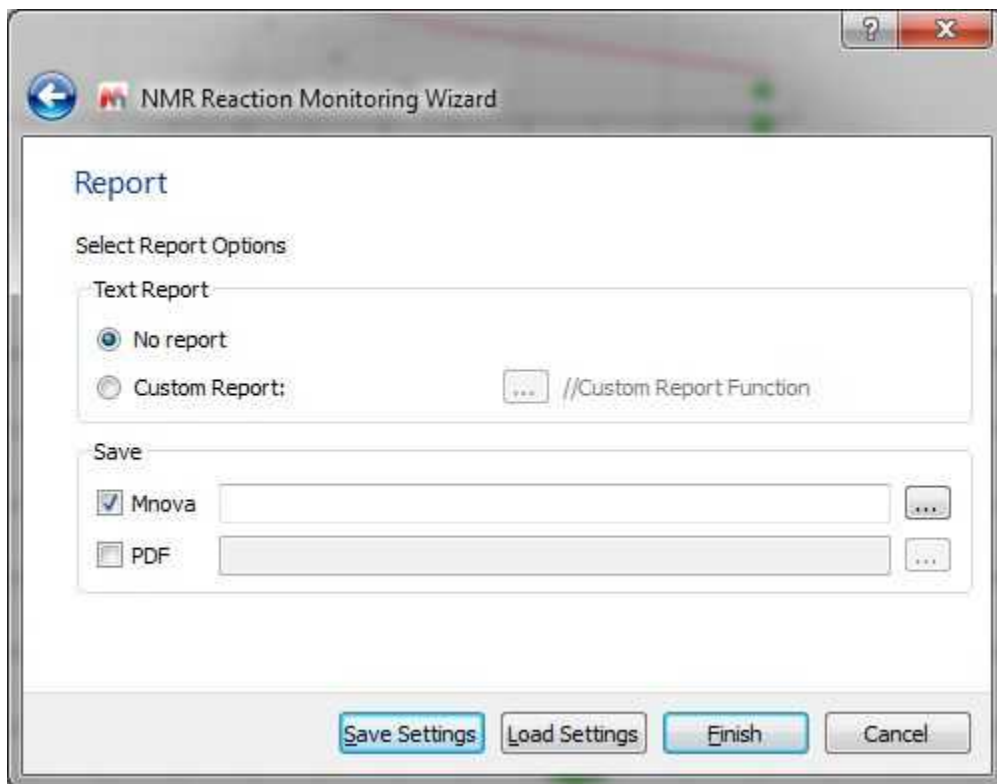

Reaction Monitoring Listener: The listener will automatically import, stack and save any dataset that arrive to the selected folder

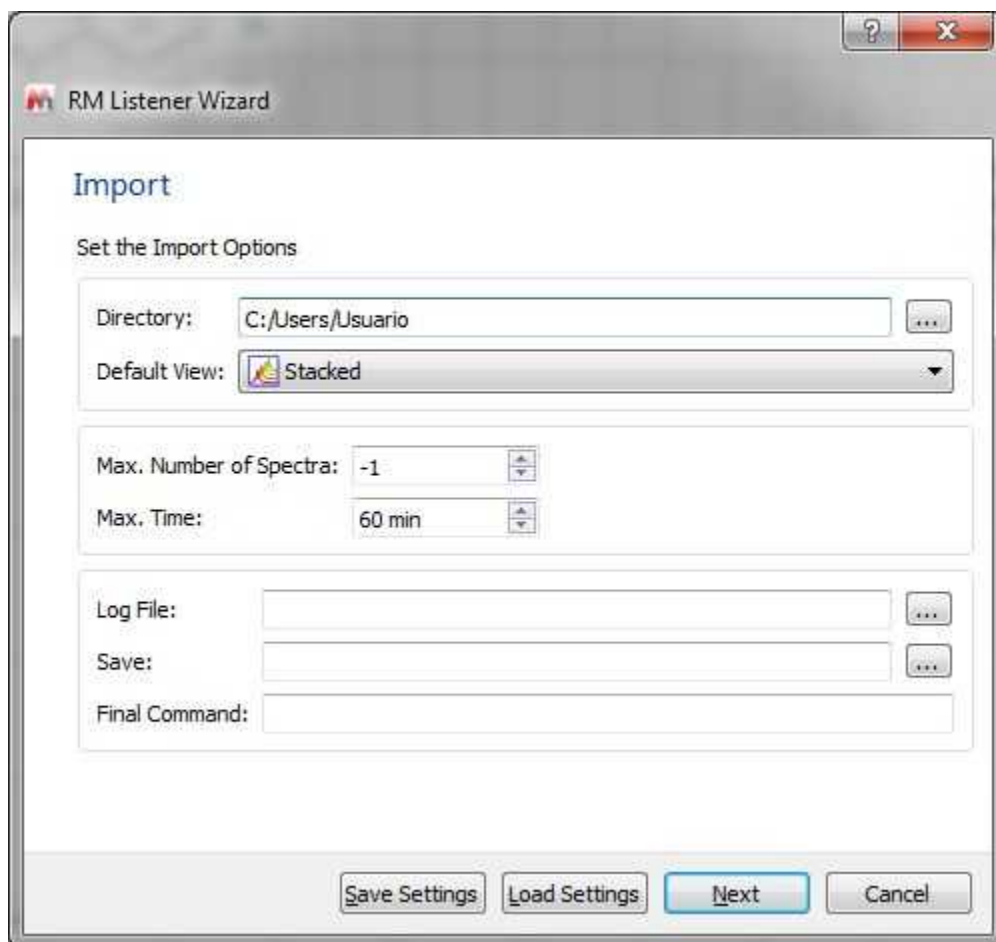

Importing of R-M data sets acquired in arrayed mode

If your dataset has been acquired in arrayed mode, it will be enough to drag&drop the FID (Varian) or SER file (Bruker) to Mnova.

Mnova supports, in addition to Reaction Monitoring, Relaxation (T1/T2) and PFG (DOSY) experiments (in other words, it will parse the arrayed parameter automatically).

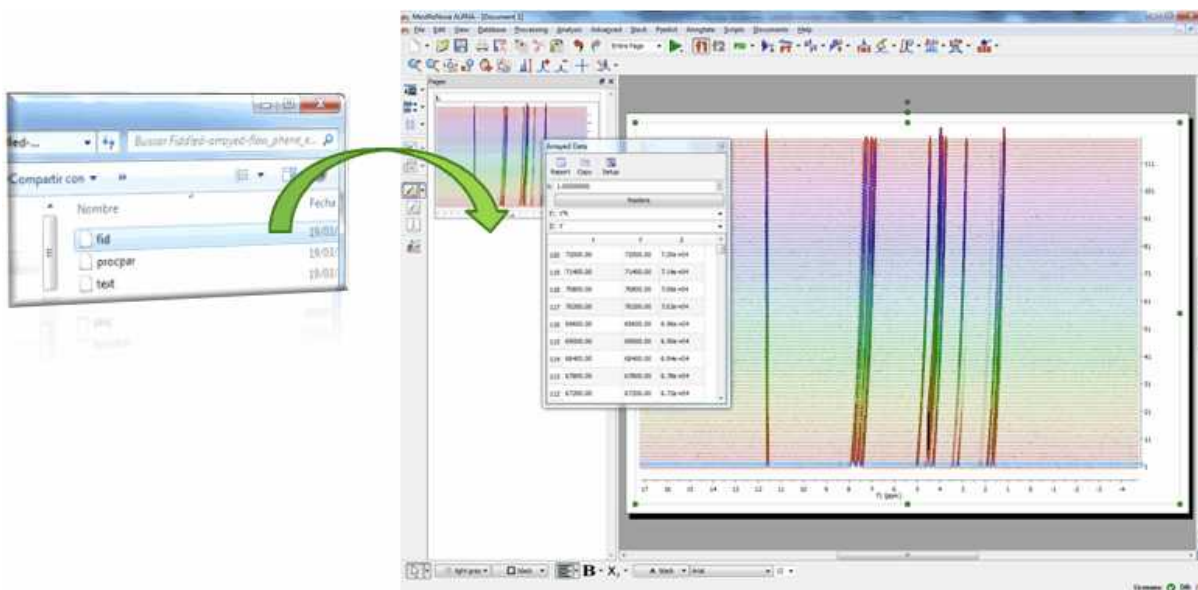

In either case, Mnova will automatically read the values of the arrayed parameter, e.g. time stamp and populate the corresponding arrayed data table

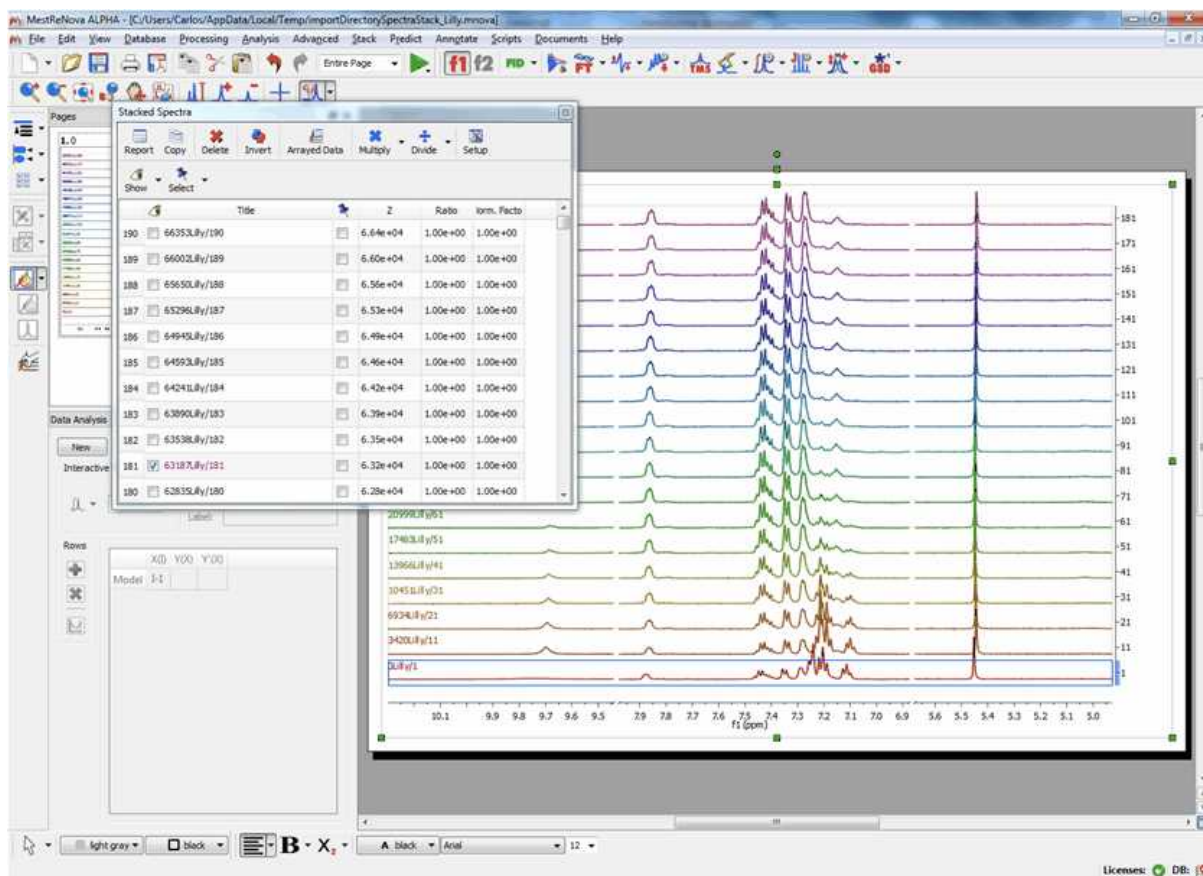

10.3.3.2 Selecting Regions

Once you have imported your datasets, you can select the 'Reaction Monitoring' regions of interest by following the menu 'Advanced/Reaction Monitoring/Select RM Regions' or by clicking on the applicable button of the toolbar

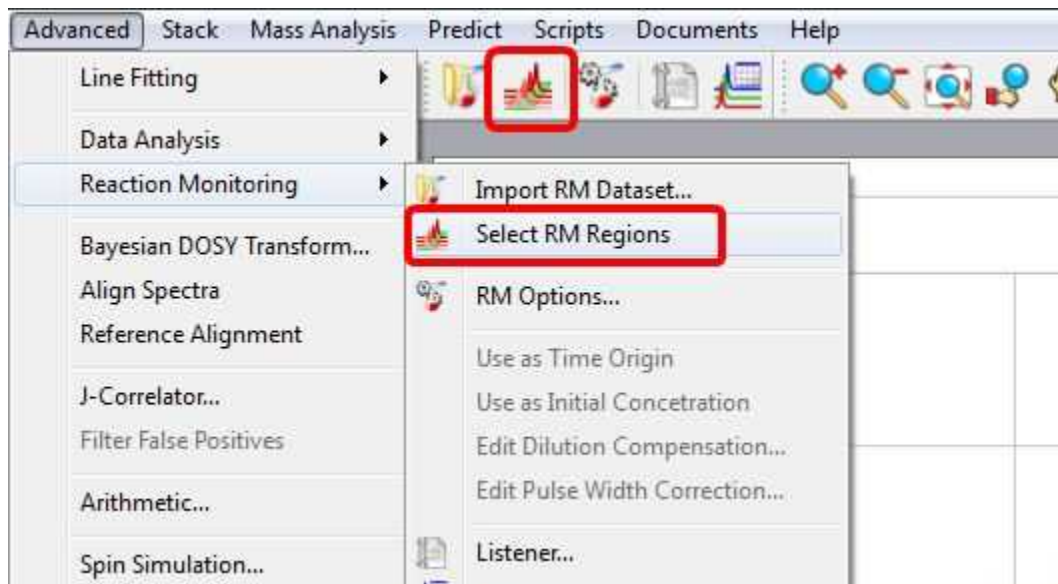

Once you have selected the first region in your stacked plot, you will be asked to type the number of nuclides and concentration value. Once you have typed the values, the Data Analysis panel will be filled.

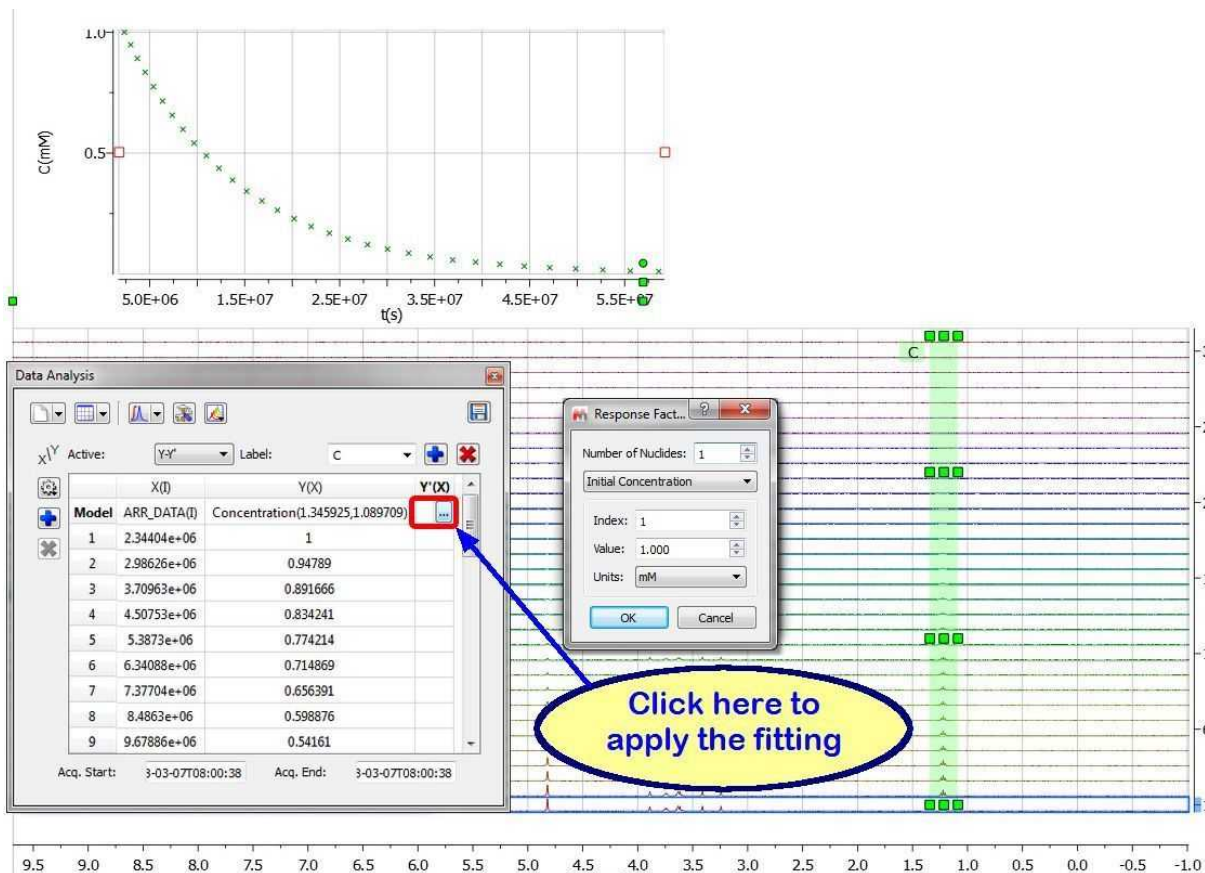

Next click on the '3 dots' button of the Y'(x) column to select the desired fitting (Mono-Exponential in the picture below). Next, click on the 'Calculate' button to generate the parameters of the fitting and finally click on the OK button to draw the fitting curve.

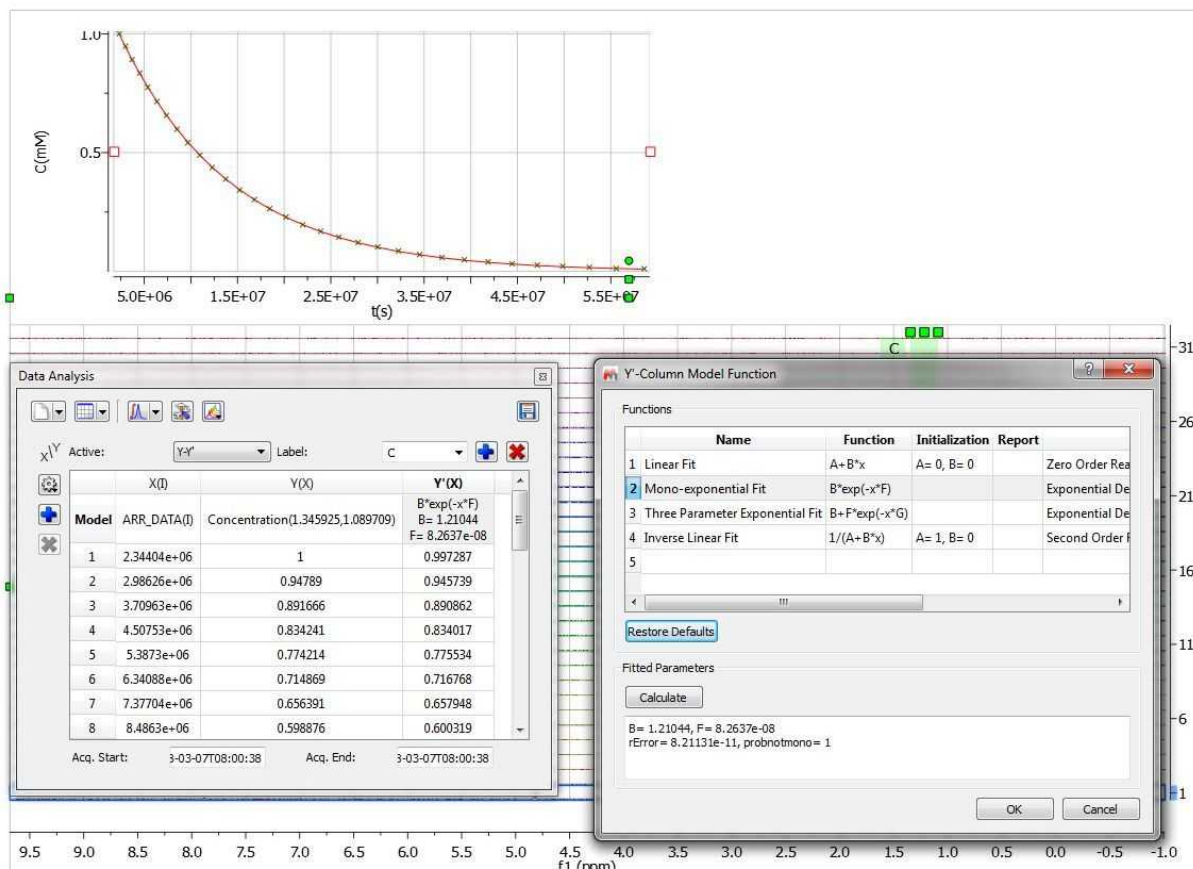

You can easily report the result by selecting any of the options under the 'Report' scroll down menu of the Data Analysis panel:

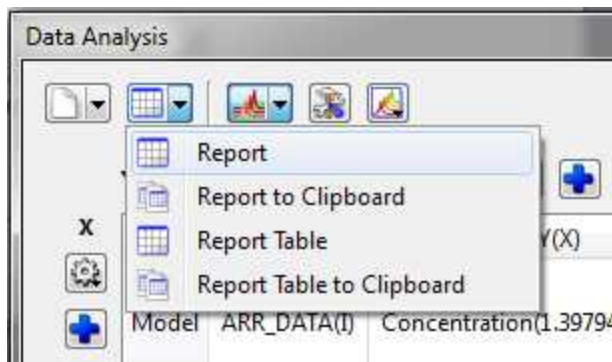

In this panel; you will also find a button ("Reaction Monitoring") which contains all Show and Select options from Stacked Spectra table, and options to show/hide Stacked Spectra and Arrayed Data tables. The button is only visible when RM plugin is installed and licensed:

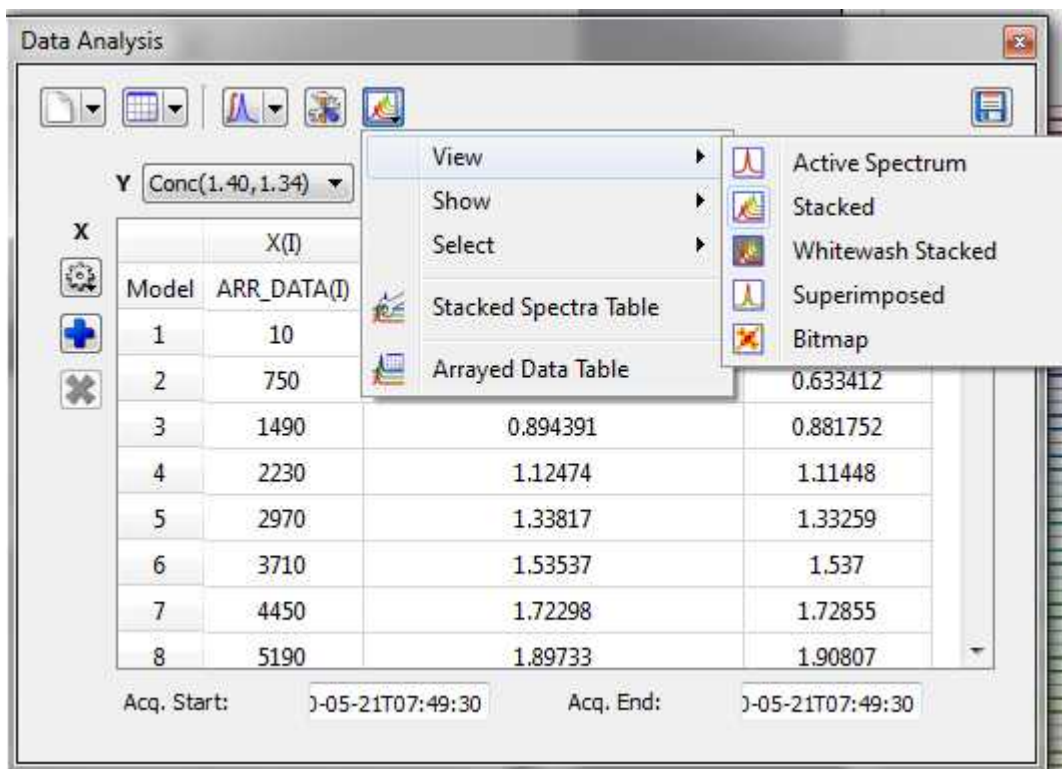

You will also find the options related to X and Y models grouped in two buttons:

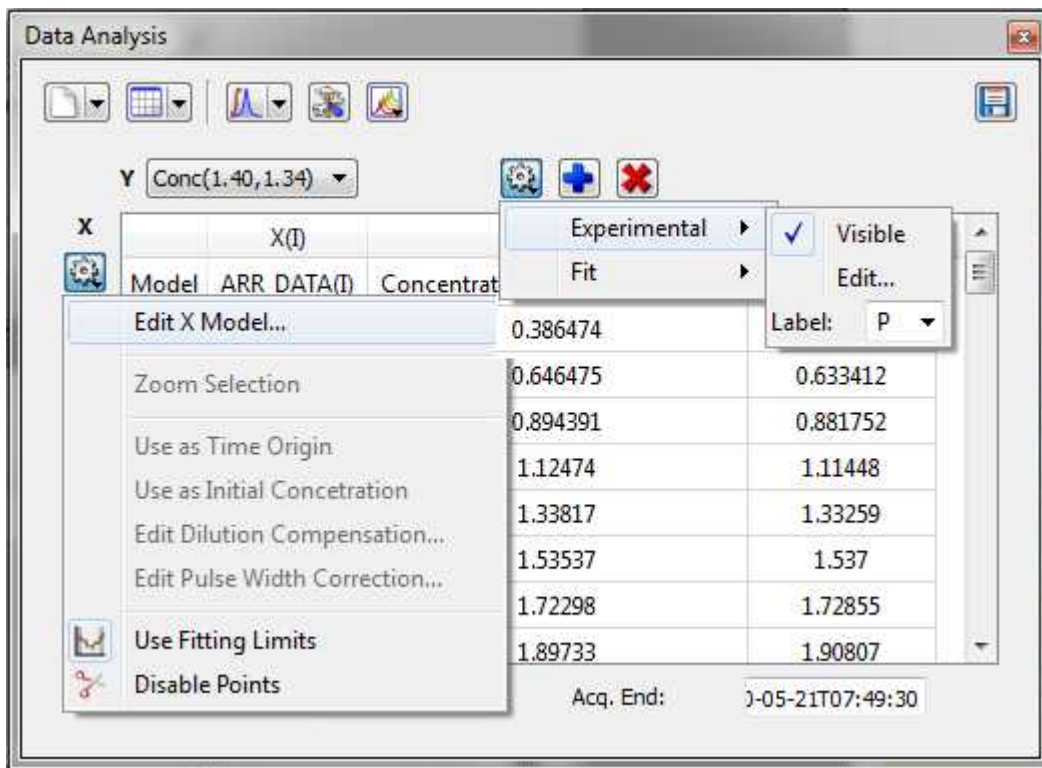

It will be possible to allow Mnova to try to guess the order of the reaction, fitting the data to standard equations and comparing the mean square error. To do it just follow the menu 'Advanced/Data Analysis/Edit/Fit to Best'.

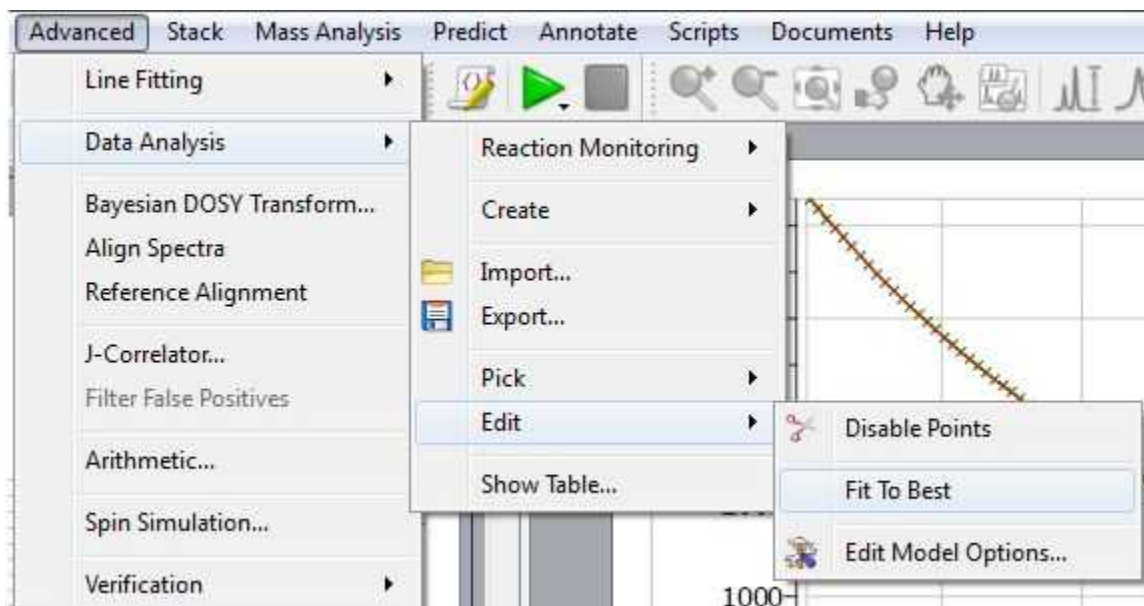

With the *Reaction Monitoring* plugin enabled, if you right click on any point of the Data Analysis Graph (or Table), you will be allowed to 'use that point as time origin or as 'Initial Concentration', or to set the Dilution Compensation Parameters' and 'Pulse Width Correction':

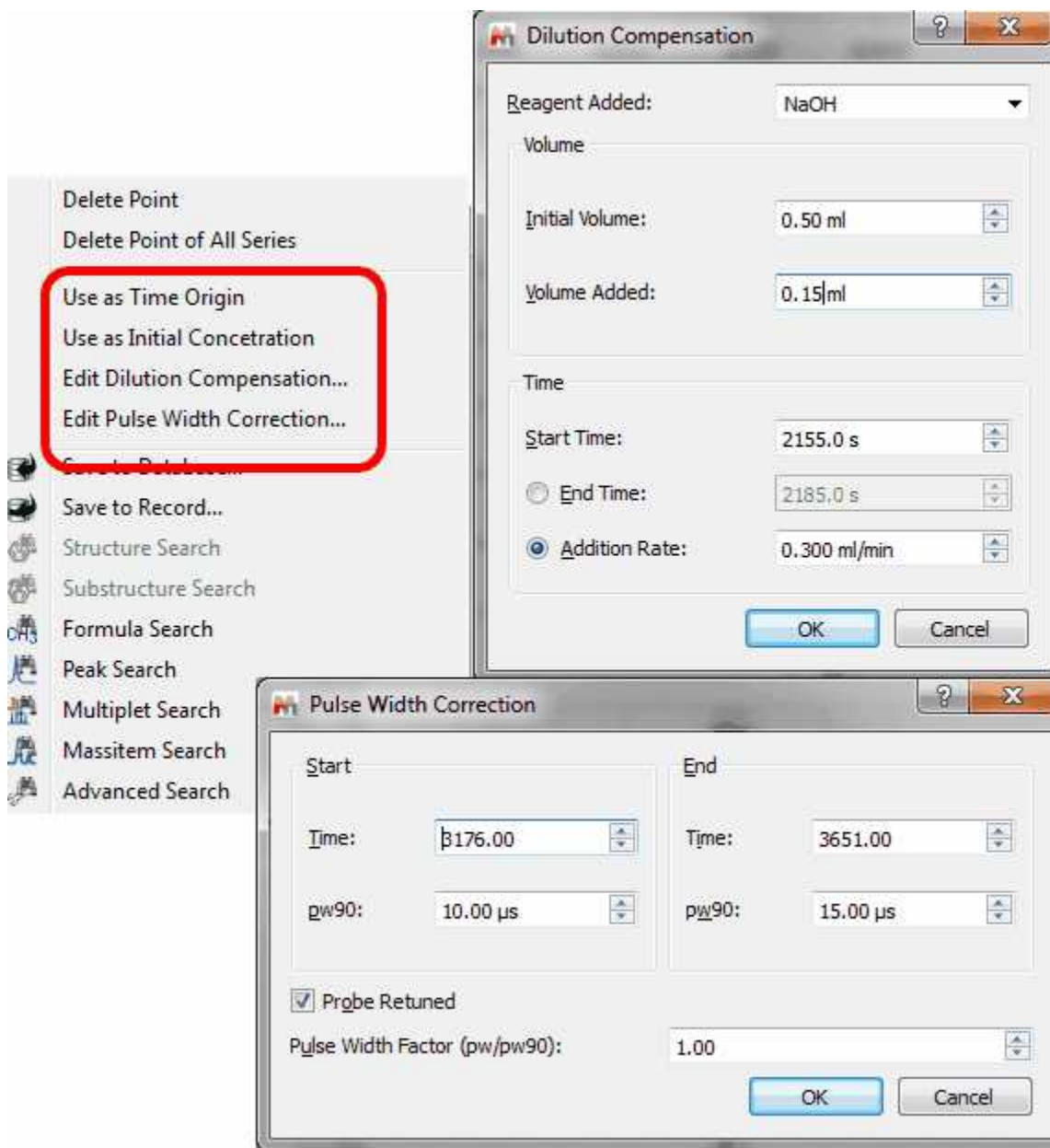

10.3.3.3 RM Options

Following the menu 'Advanced/Reaction Monitoring/RM Options', you will be able to select the desired option for your analysis:

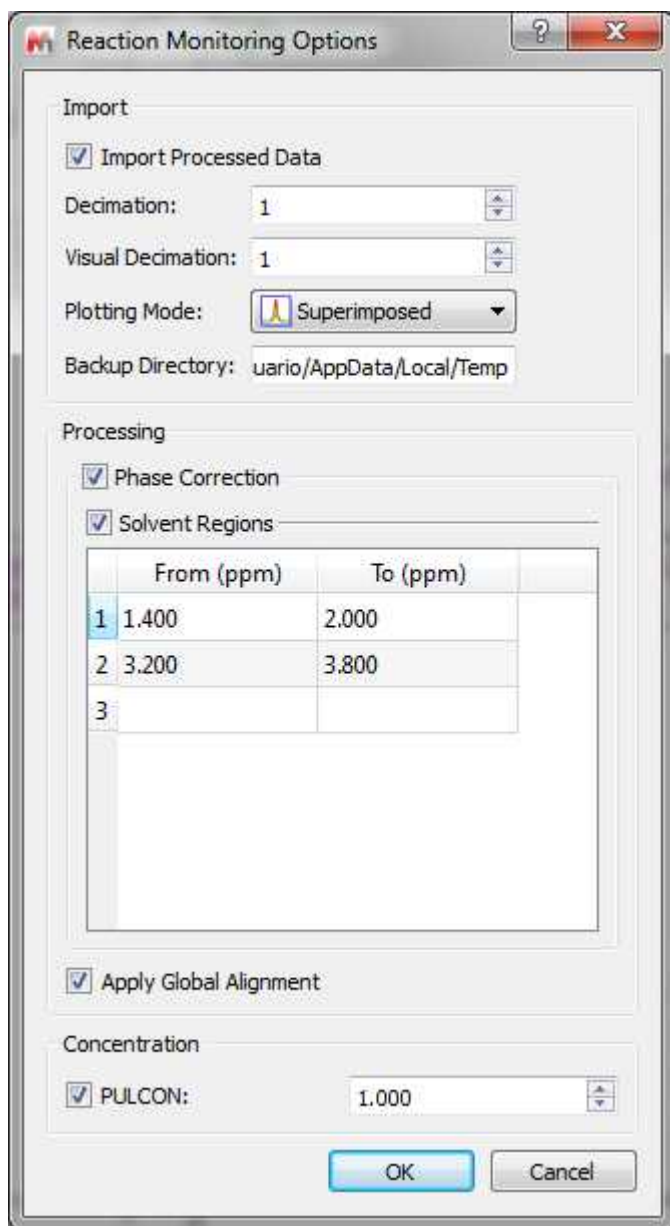

10.3.3.4 Handling of Arrayed Spectra

The main features to handle arrayed spectra will be described below:

- Multiple display modes: Stacked, superimposed, active, bitmap
- Ability to select multiple spectra and apply processing only to those selected spectra
- Ability to hide any number of spectra
- Multiple selection can be done either graphically in the stacked plot mode or by means of a table
- New powerful algorithm for the automatic alignment of arrayed spectra
- Ability to automatically import any number of spectra and automatically stack them
- New selection mode to extract NMR descriptors (e.g. integrals) with the ability to adapt its shape to any profile (useful when peaks are not aligned)

As you well know there are several display modes of arrayed datasets, as stacked, superimpose, active or bitmap. You can select the mode by using the scroll down menu of the vertical toolbar:

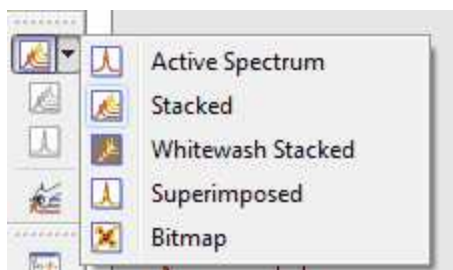

'Active Spectrum': to see only the highlighted spectrum. Within this mode, it's possible to navigate along all spectra in this stack by using Shift+Mouse wheel (or arrow keys up&down).

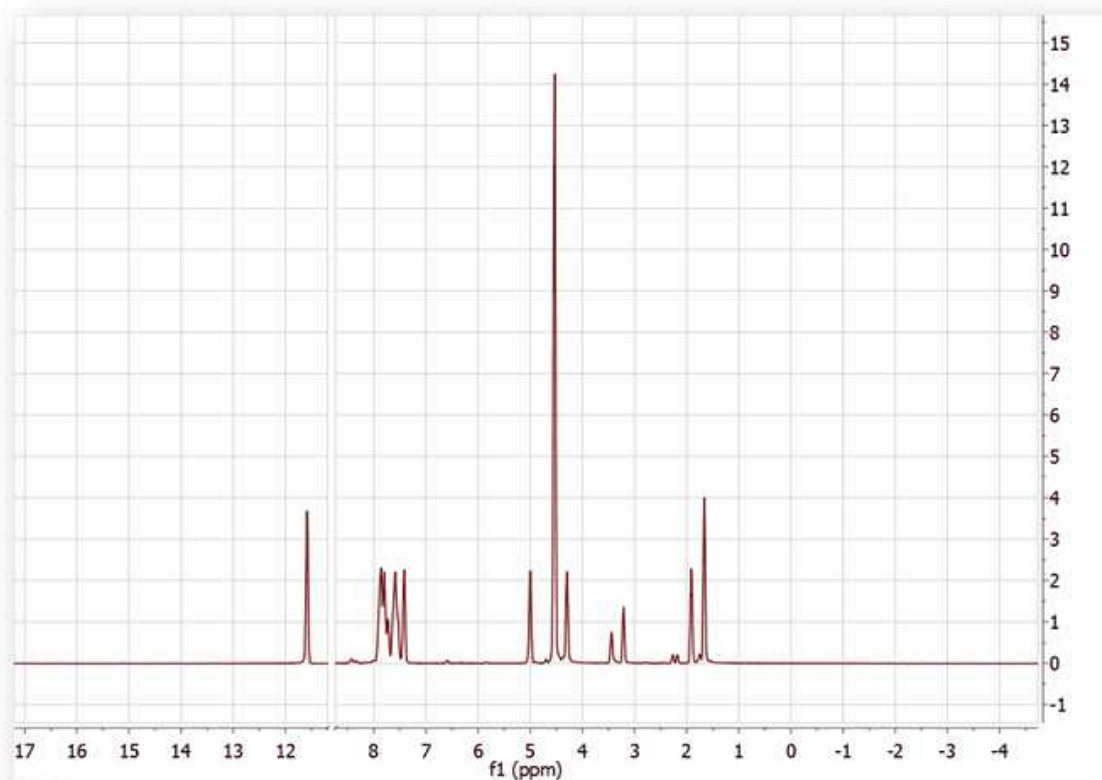

'Stacked': to see all the spectra in arrayed mode. It is possible to change the angle from the Properties dialog box.

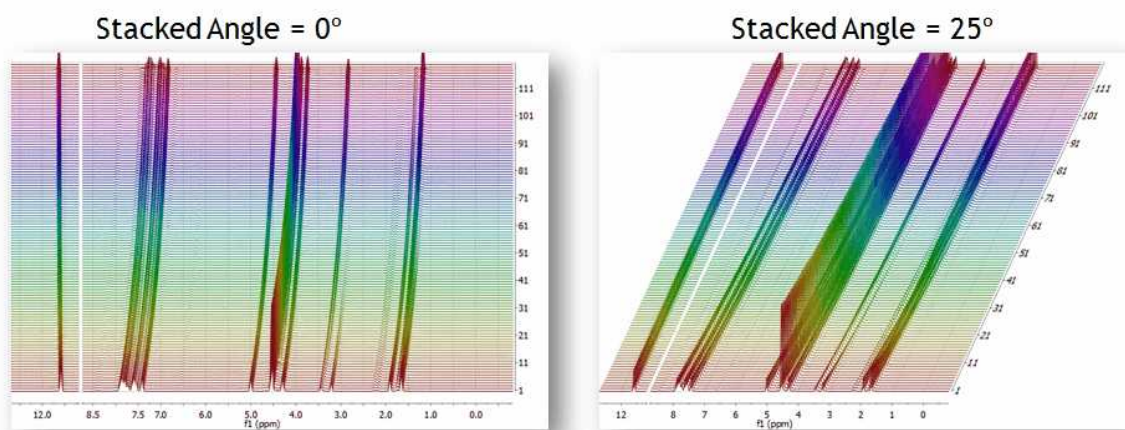

'Superimposed': to see all the spectra overlaid (one over another).

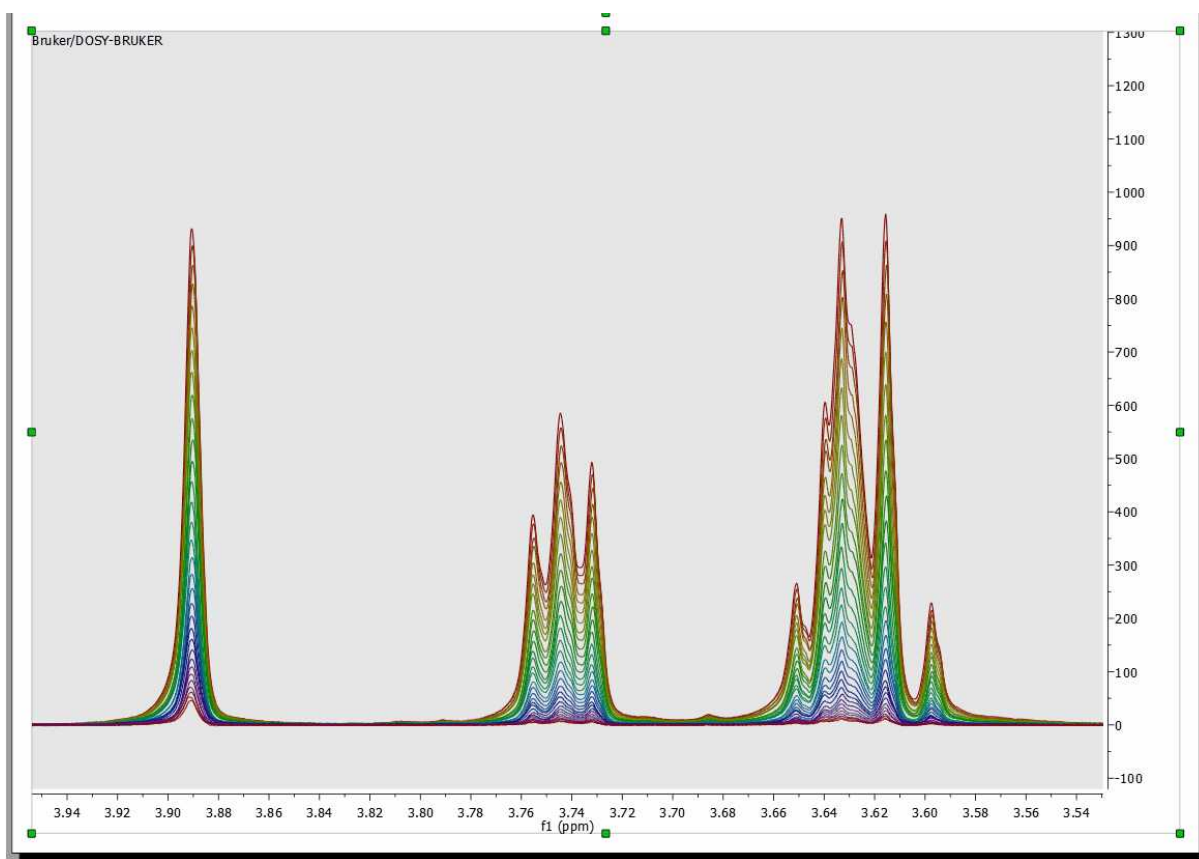

'Bitmap': to see all spectra in a bitmap mode.

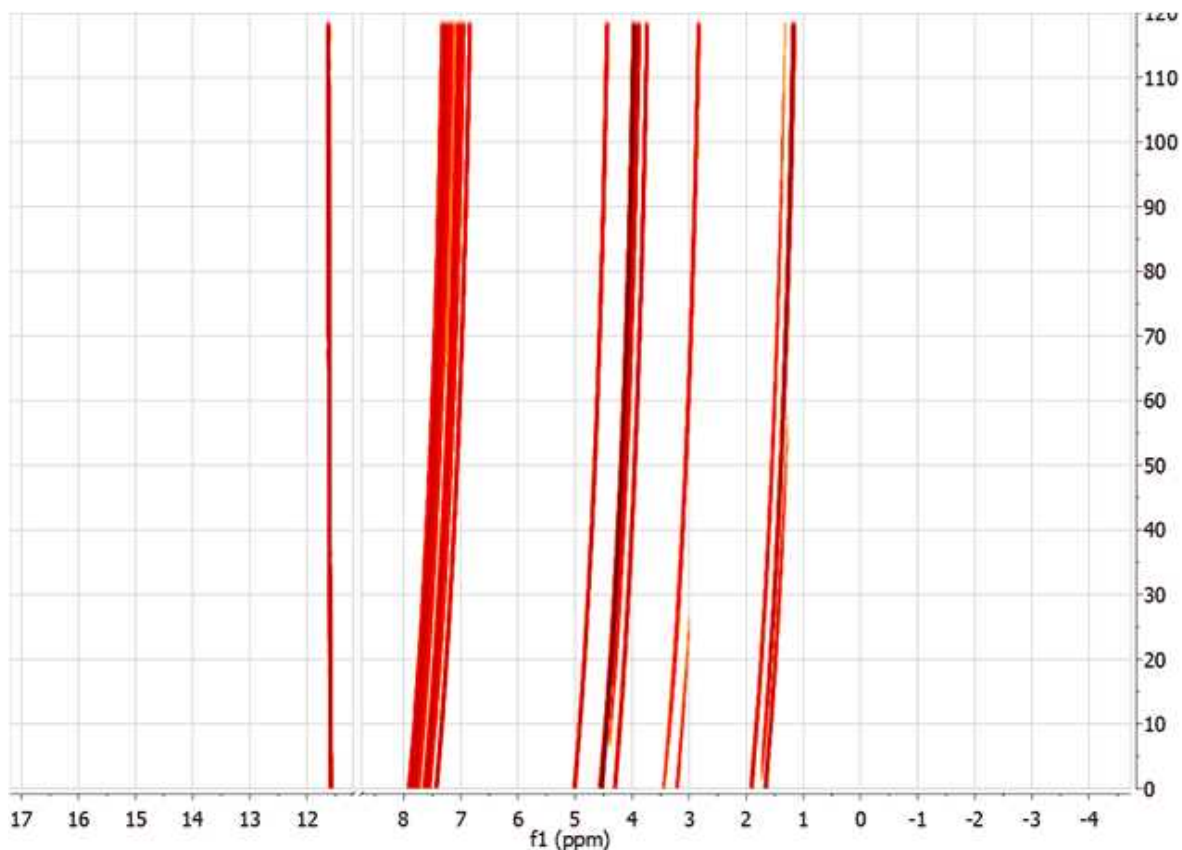

Multiple Spectra Selection

Up until now, Mnova had the ability to apply any processing operation to all spectra or just to active spectrum in an arrayed item (stack)

Now Mnova includes a powerful, yet easy to use **multiple spectral selection** mode, which allows the user to optimize the processing of groups of spectra by selecting a bunch of spectra and applying any processing (e.g. manual phase correction to the selected group)

Multiple spectra selection can be done either graphically from the stack or directly from a table

In addition, Mnova now offers the ability to hide any number of spectra in an arrayed item.

Graphical selection of spectra

In order to be able to select a bunch of spectra **graphically** with the mouse, it is necessary to display the spectra in the stacked plot mode

To select a single spectrum, **left click** on the spectrum trace while keeping pressed the **Alt key**

To deselect a spectrum: **left click + Ctrl + Alt**

In order to select multiple spectra, follow the same operation as above while keeping pressed **Ctrl and/or Shift keys**.

The following slide will show how to select several groups of spectra

Some important concepts: Active spectrum vs Selected spectrum/spectra

Selected spectra: when the spectra are selected, they are highlighted with a light blue background. Any processing operation will take place only for those selected spectra

Active Spectrum: active spectrum is marked with a blue box and it indicates the spectrum which will be displayed in the *active spectrum* display mode. It's also the reference spectrum used in some processing operations (e.g. alignment)

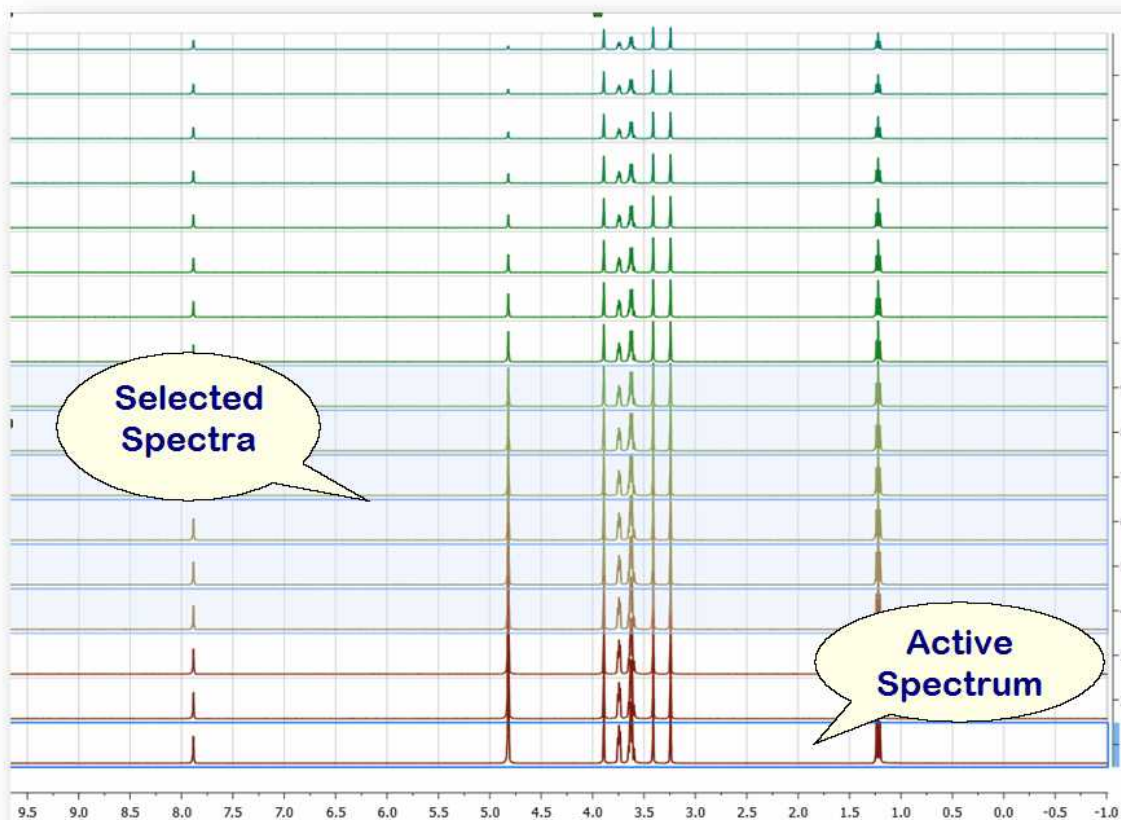

Example #1:

If there are no spectra selected and the active spectrum is not either selected (i.e. no spectra have a blue background) then **any processing operations will be applied to ALL spectra** (Active spectrum is not selected)

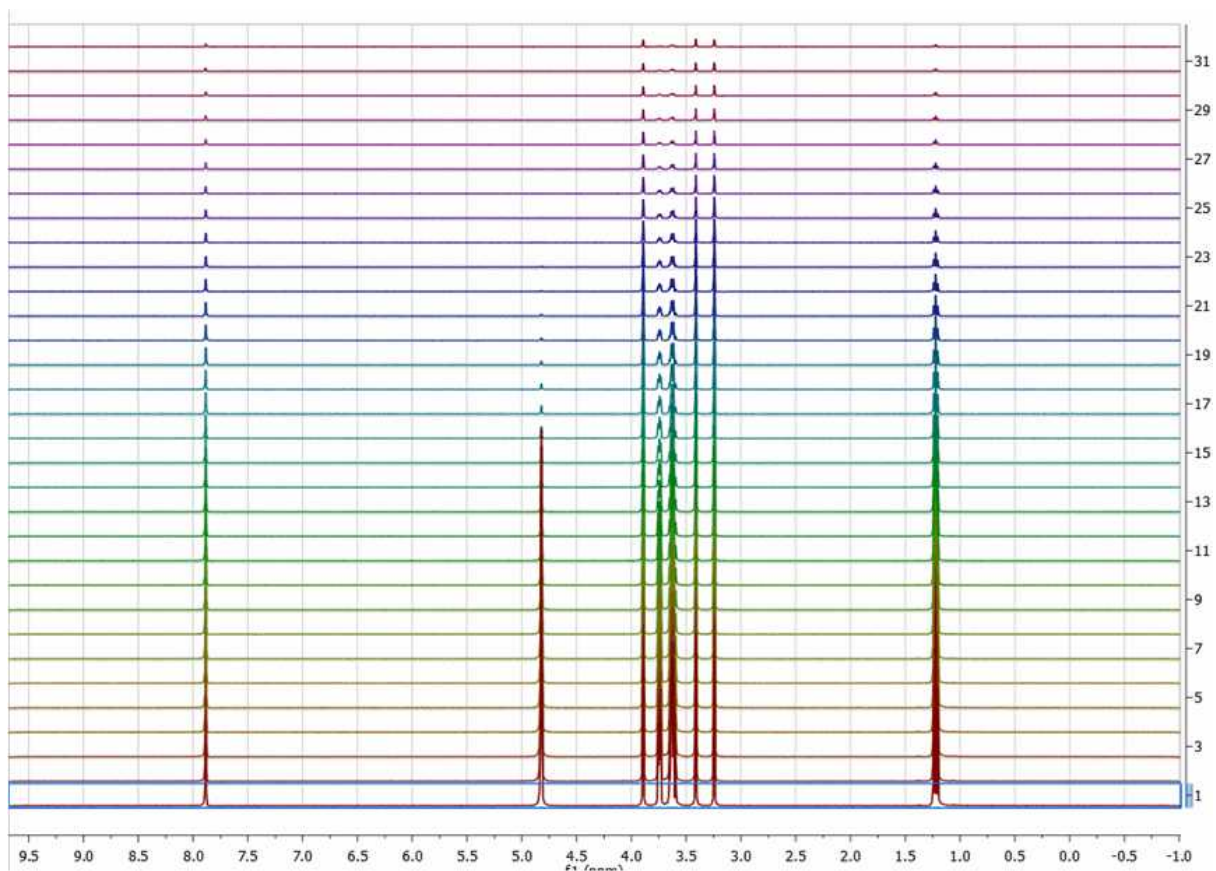

Example #2:

If only the active spectrum is selected, **any processing operations will be applied ONLY to the active spectrum.** (Remember, to select a spectrum: left click + Alt)

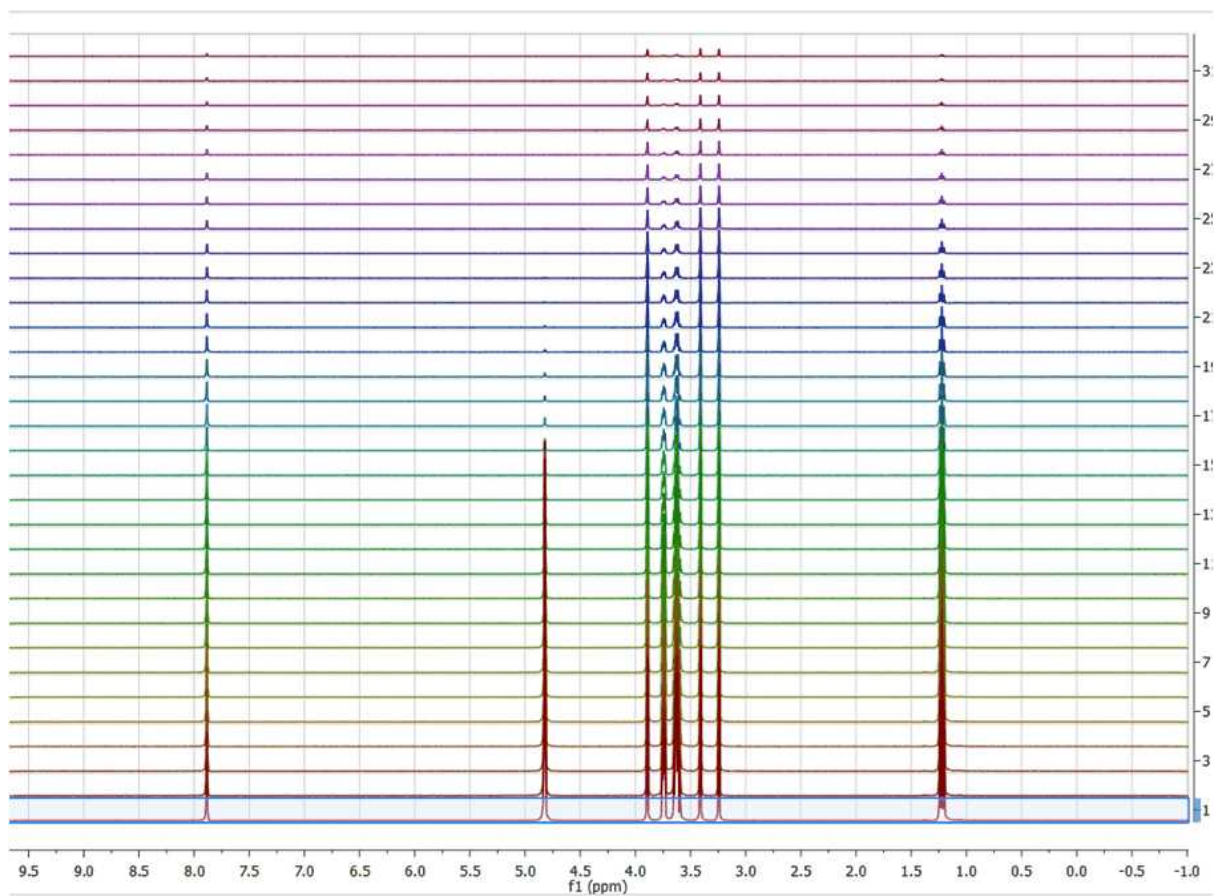

Example #3:

In general, **any processing operation will be applied only to the selected spectra** (and remember that if no spectra are selected, All spectra will be processed):

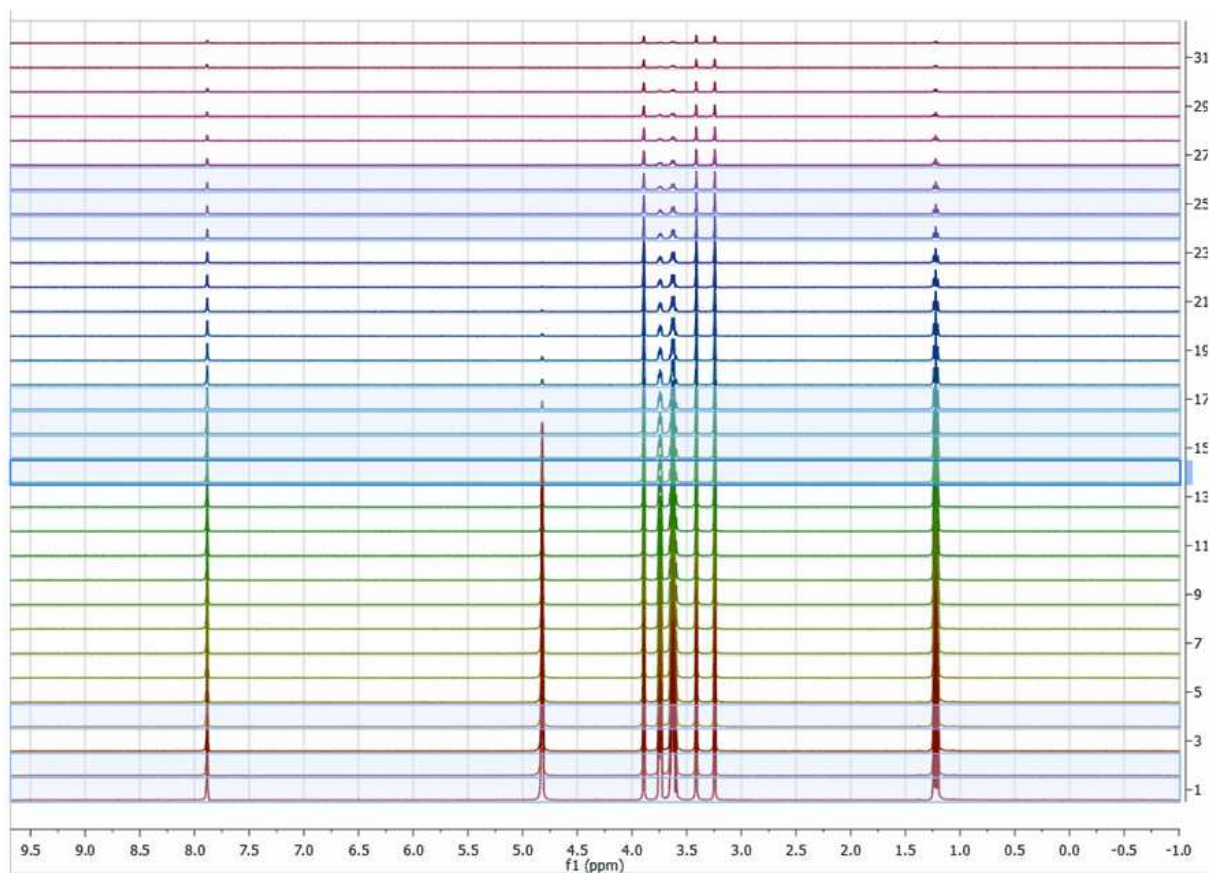

See also ['Table of stacked spectra'](#)

10.3.4 T1 Analysis

Let's see how to use the Data Analysis feature to calculate the T1 value of a 1H-NMR dataset.

Firstly, load your dataset into Mnova and make sure that the phase is right (if not correct it by using the 'Manual Phase Correction tool):

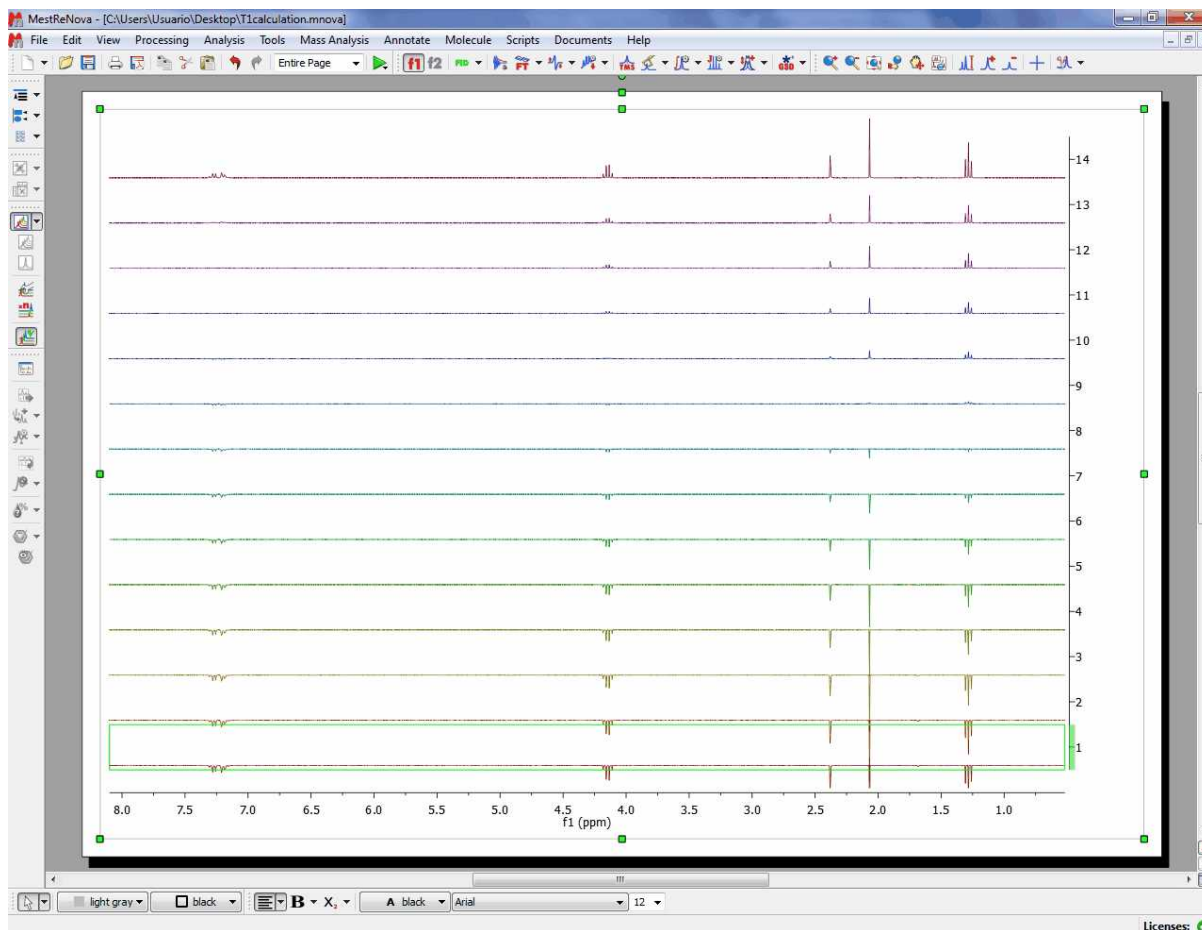

Follow the menu 'Advanced/Data Analysis/Create/Integrals Graph' and select the desired signal to analyze (i.e. the singlet at 2.38 ppm). You will notice how the graphical plot will be updated with the integral values:

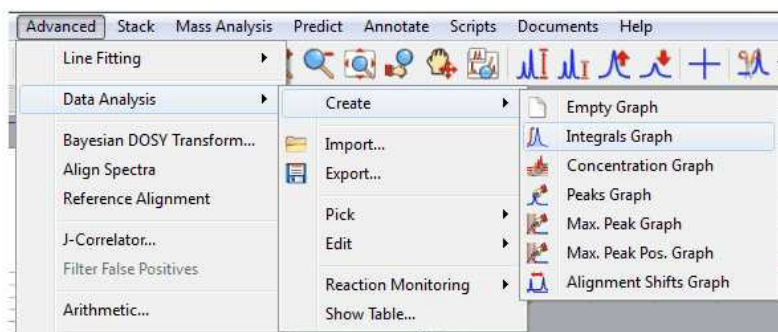

Finally double click on the Y'(X) cell, select the 'Three parameter exponential Fit' ($B+F \cdot \exp(-x \cdot G)$) and click on the Calculate button

The image shows two overlapping dialog boxes from the MestreNova software. The top dialog, titled "Data Analysis", contains a table with the following data:

	X(I)	Y(X)	Y'(X)
Model	ARR_DATA(I)	Integral(2.294,2.428)	
1	0.250	-54705.074	
2	0.300	-52173.328	
3	0.500	-47078.699	
4	0.800	-39973.512	

The bottom dialog, titled "Y'-Column Model Function", displays a list of functions:

Name	Function	Initialization	Report	Description	Algorithm
1 Mono-exponential	$B \cdot \exp(-x \cdot F)$			Exponential Decay (e.g DOSY)	monoExpone...
2 Three parameter exponenti...	$B + F \cdot \exp(-x \cdot G)$		T1= 1/G;	Exponential Decay with Baseline ...	monoExpone...

Below the function list, the "Fitted Parameters" section shows the following values:

B= 73534.4, F= -134007, G= 0.205373
rError= 0.00141019, probnotmono= 0.999909

The T1 value will be the inverse of the G value, so in that case the T1 value for the proton at 2.38 ppm will be 4.87 seconds. Here you can see the result:

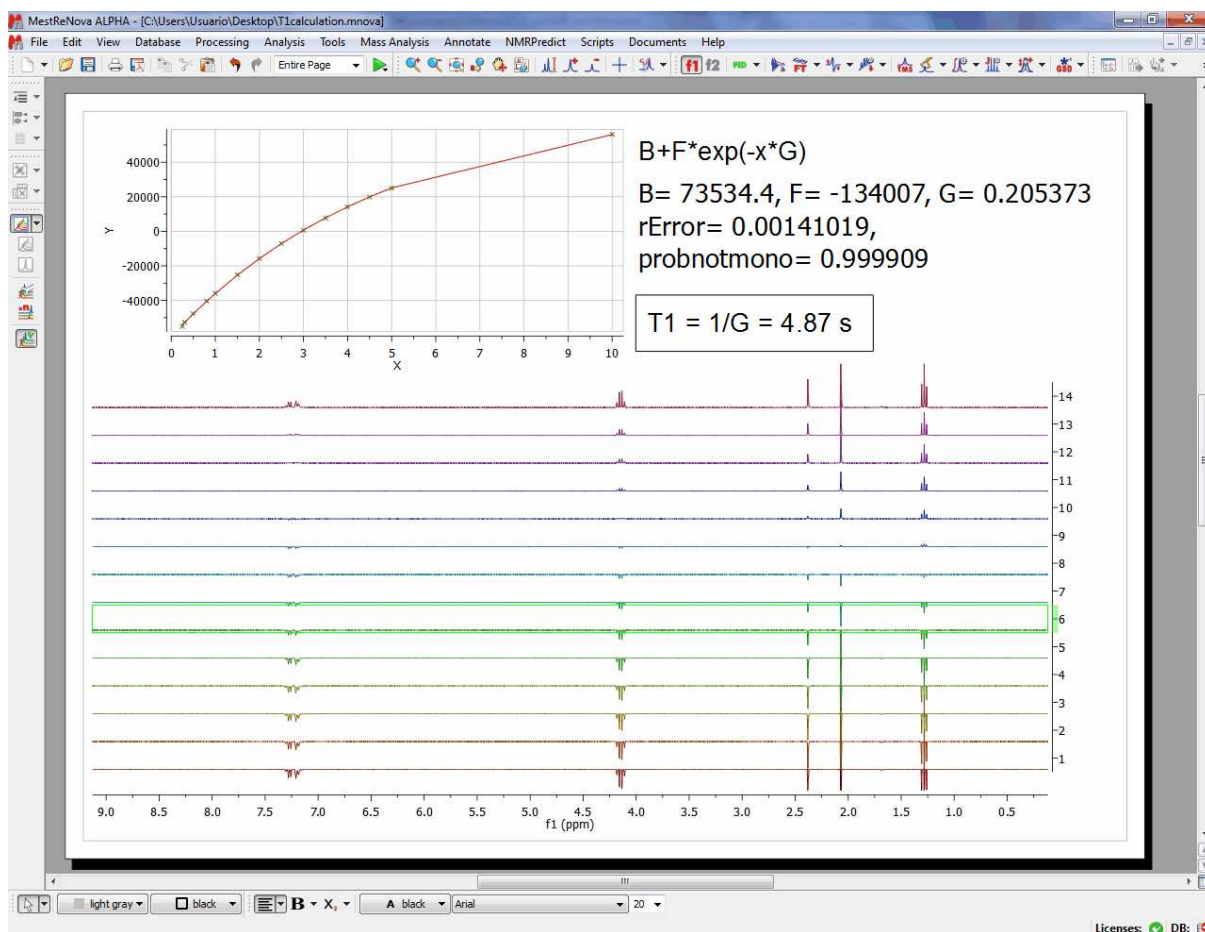

10.3.5 Data Analysis Properties

It is possible to modify the properties of the graphic representation, just by double clicking on it to display the 'Properties dialog box' which contains three labels (Y/Y', Axes and Basic). In the first label you will be able to change the style, color and width of the Experimental and Fitted lines

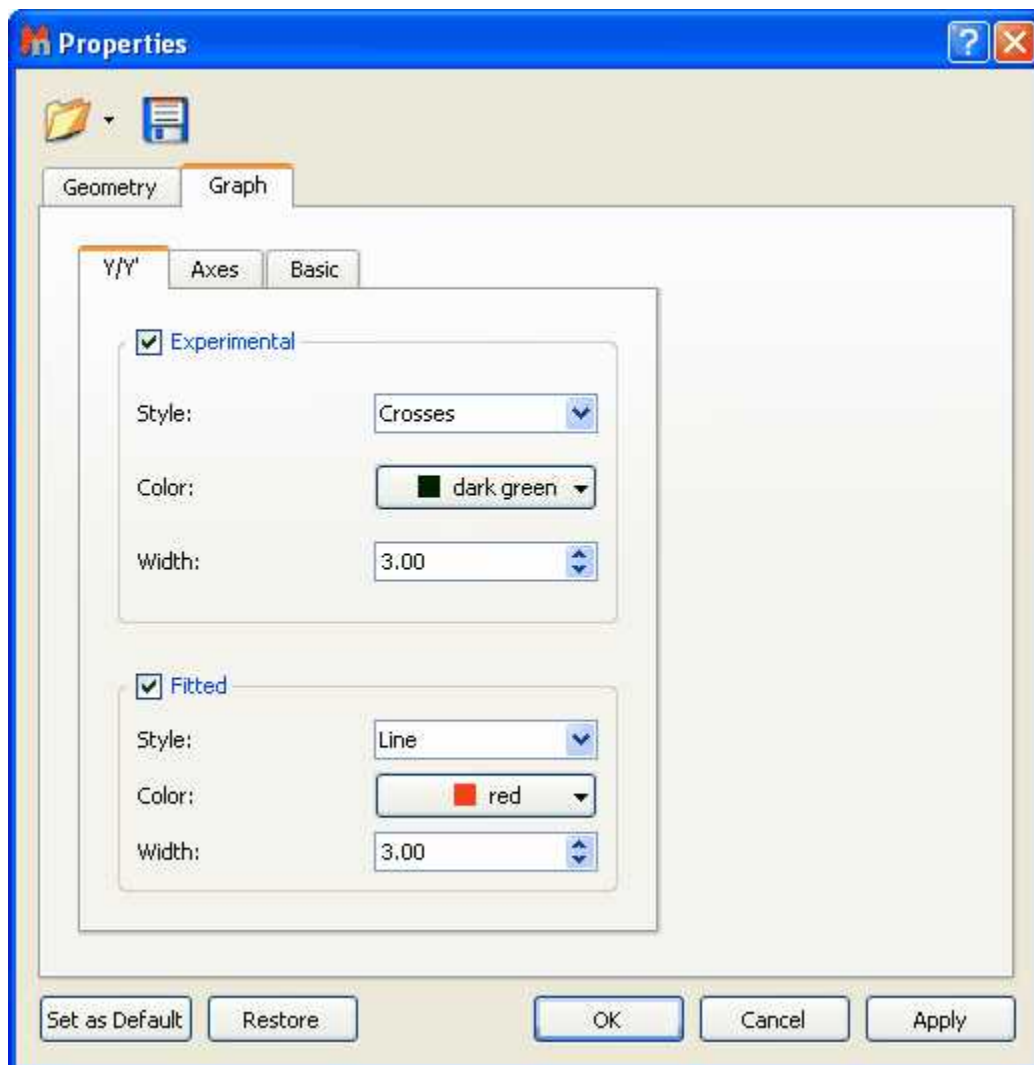

Selecting the Axes label will allow you to change the color, font and margin of the axes and also to select the units scale (seconds, minutes, hours, points) and the capability to select Logarithmic values or to change the label of each axis:

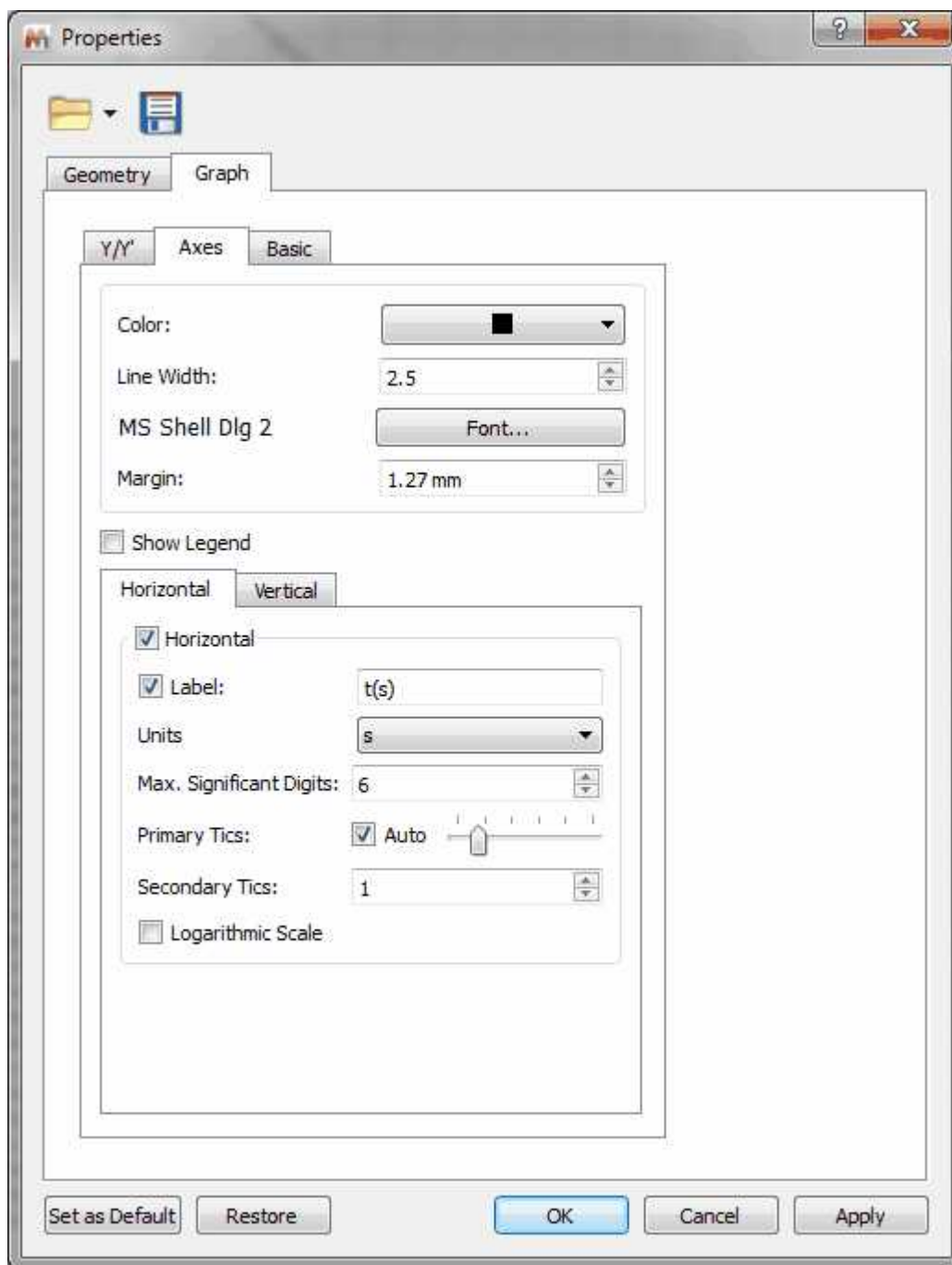

Clicking on the Basic label will allow you to change the background, the grid and also to show the corresponding legend:

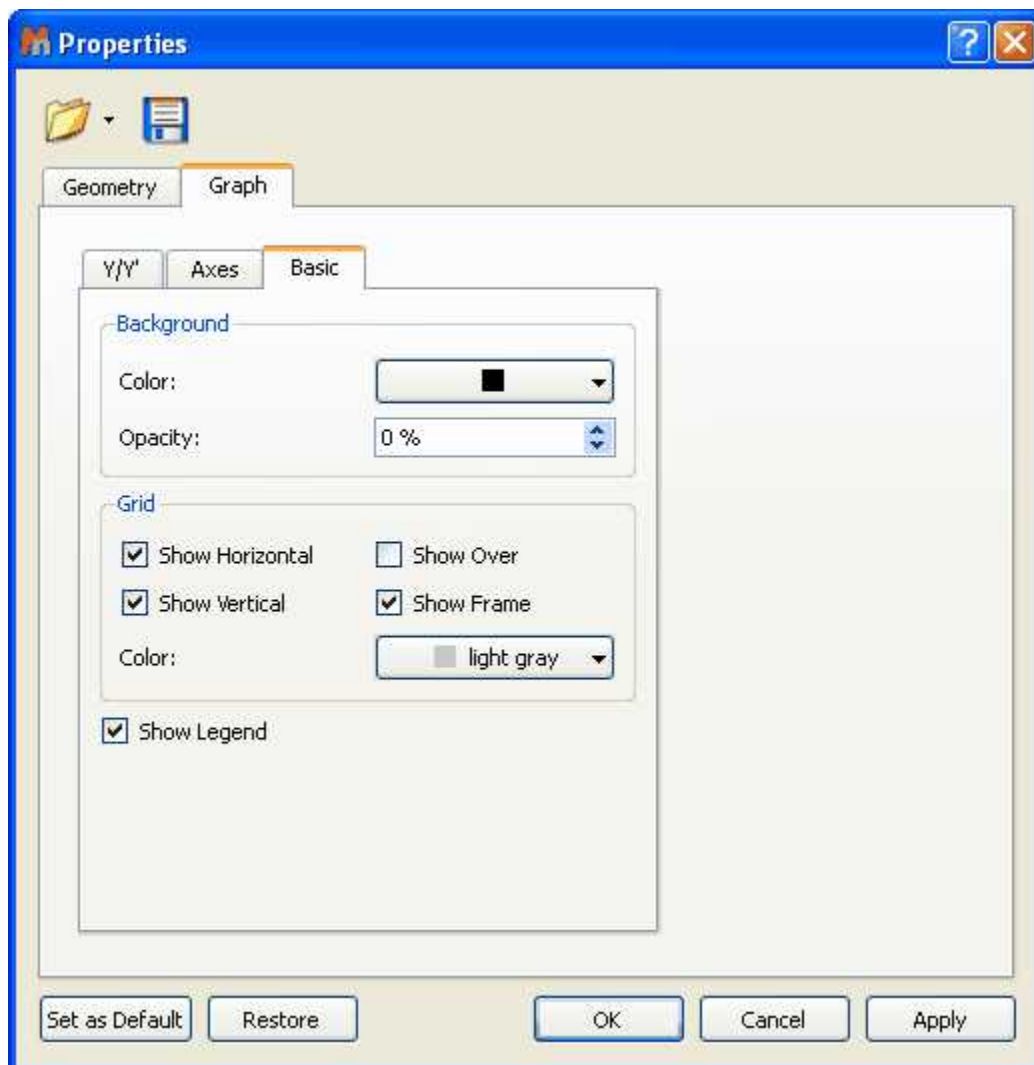

10.4 Reference Alignment

This feature will be used to manually align the chemical shift of 1D or 2D spectra (very helpful in Metabonomics), that is, to correlate signals of 1D or 2D spectra.

Just select, in the page navigator, the spectra that you want to align and follow the menu 'Advanced/Reference Alignment'. All the spectra will be aligned with the first one.

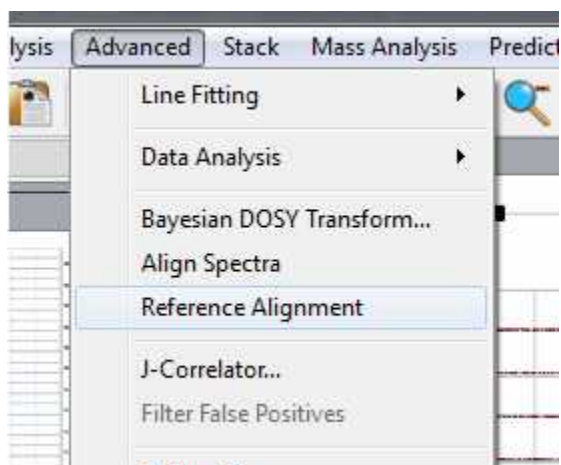

You can also use this feature to align stacked spectra. In that case, the method uses the active one and then aligns all remaining spectra by maximizing the cross-correlation between the reference spectrum and the spectra to be aligned:

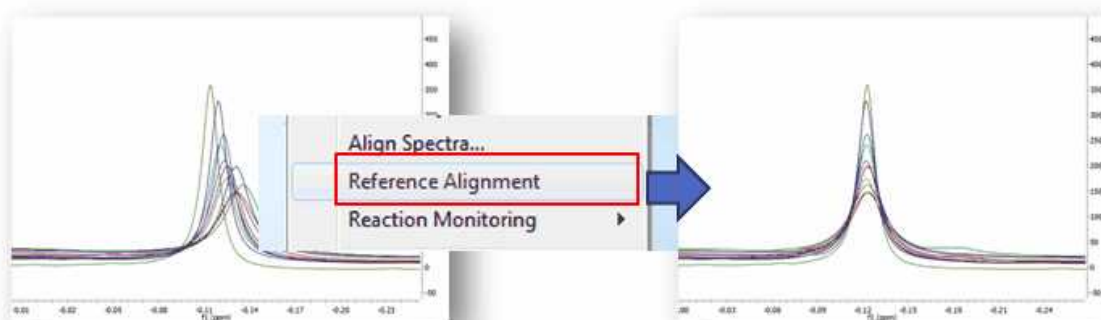

The idea of global alignment is very simple and corresponds to the well-known chemical shift referencing method in which the user sets the internal reference peak (e.g. TMS, DSS, TSP, etc) of each spectrum to e.g. 0 ppm. In order to cope with small fluctuations in chemical shifts, this method seeks for the highest peak within a narrow (user-defined, auto-tuning option in Mnova) interval, as depicted in the figure above.

See also [Align Spectra](#).

10.5 Align Spectra

The **chemical shift** is of great importance for NMR spectroscopy because it reflects the chemical environment of the nuclides under observation providing detailed information about the structure of a molecule.

Although the chemical shift of a nucleus in a molecule is generally assumed to be fairly stable, there are a number of experimental factors (pH, salt concentration, solvent, field inhomogeneity –bad shimming, etc) which might produce slight or even quite significant variations in chemical shifts.

This is particularly important in **metabonomics/metabolomics** NMR where shifts of NMR peaks due to differences in pH and other physico-chemical interactions are quite common in NMR spectra of biological samples. For example, some important metabolites, such as citrate or taurine, have peaks whose chemical shifts fluctuate in an uncontrolled way from sample to sample. These variations can cause spurious grouping of samples in chemometric models.

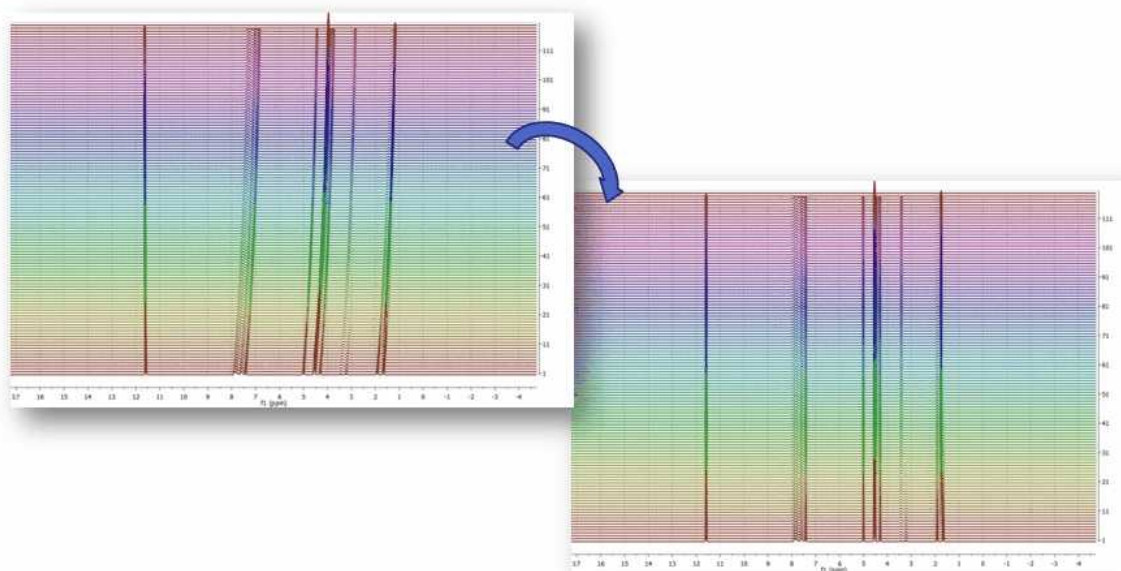

This problem is also very common in **kinetics** or **reaction monitoring** experiments by NMR. For example, consider the following reaction monitoring example:

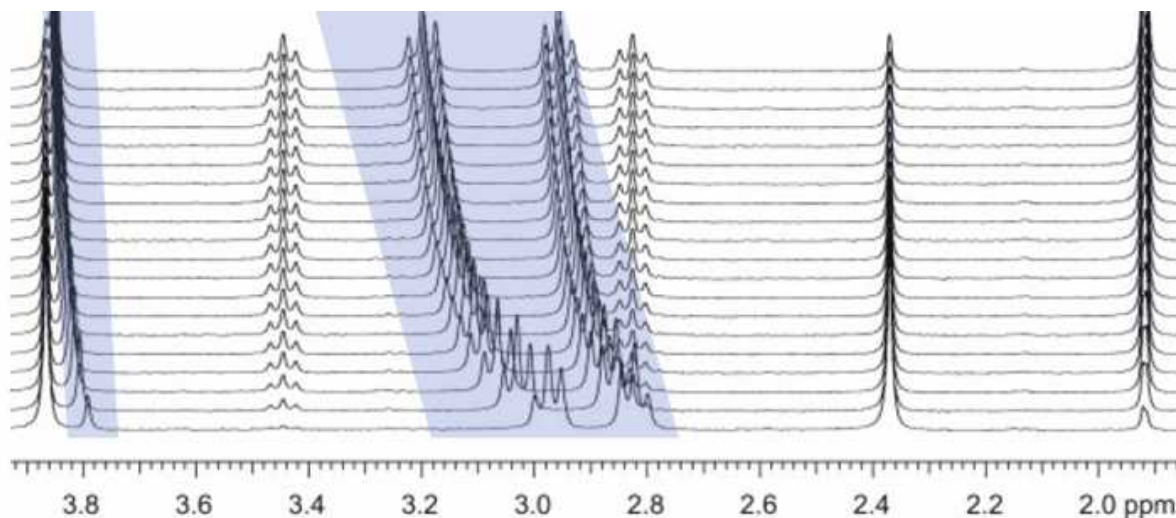

It can be appreciated that during the course of the reaction, the chemical shifts of highlighted signals change as a result of the change in pH (in this case, as a hydrolysis proceeds).

Although characterizing these chemical shifts fluctuations can be sometimes important (pH or drug binding-induced chemical shifts, for example) in general they obscure the process of pattern recognition and impede the performance of data analysis (e.g. selection of the peaks whose intensities/heights need to be monitored can be more difficult).

Whilst it is critical to setup the experimental conditions in the best way to minimize these chemical shift fluctuations (for example by using an appropriate buffer); spectral misalignments may still occur and special post-processing methods have to be employed.

In order to cope with this misalignment issue, Mnova includes several methods, namely:

- Manual (semi-automatic) global spectral referencing
- Fully automatic global spectral referencing
- Spectral alignment (including global and regional-wise spectral alignment)

The first two methods can be regarded as simple, global methods for peak alignment as they shift the entire spectrum by some constant amount, whilst the third method is much more sophisticated making possible both the global and local alignment of different spectral regions

These three methods are explained below:

1) Manual (semi-automatic) spectral referencing

This method corresponds to the well-known chemical shift referencing method in which the user sets the internal reference peak (e.g. TMS, DSS, TSP etc) of each spectrum to e.g. 0 ppm. The particularity of Mnova is that it contains an **auto-tuning** parameter which makes it possible the automatic referencing of many spectra by simply seeking for the highest peak within a narrow (user-defined) interval.

The figure below (left) shows 26 superimposed misaligned peaks. [Manual Referencing](#) using an auto-tune parameter of 0.1 ppm yields the result depicted in the figure on the right:

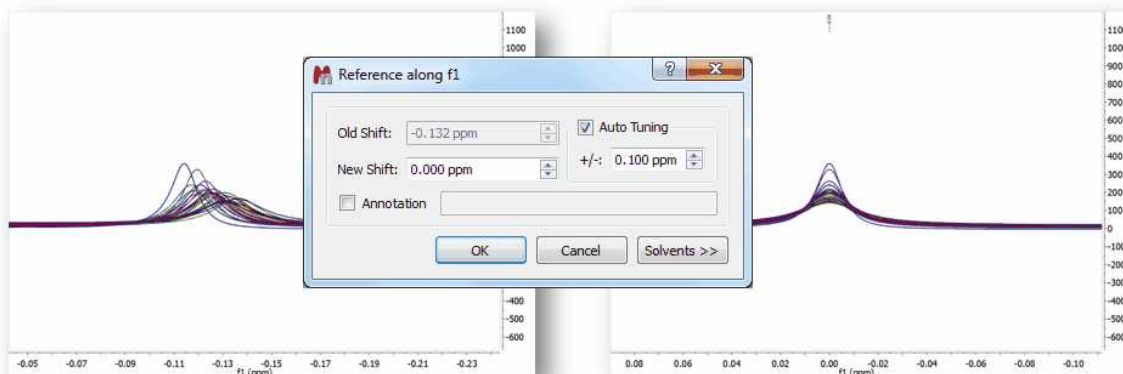

Clearly, this method will not work properly in those data sets with local misalignments, that is, when signals of one metabolite fluctuates in one direction whilst the peaks of a different metabolite move differently). As an example, let's consider a simulated data set of Taurine:

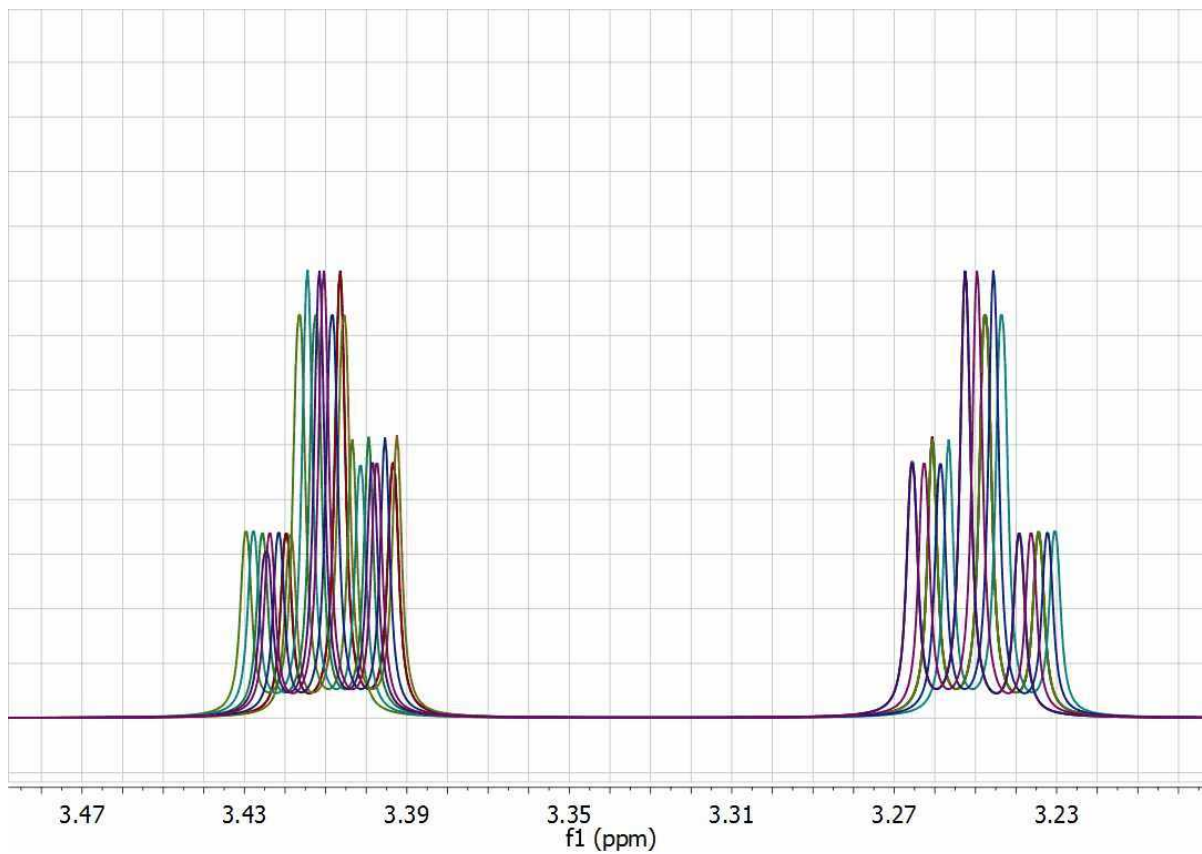

This data set has been generated by randomly changing the chemical shifts of the two CH₂ groups. Now, let's apply the global alignment procedure using as chemical shift reference at a value of 3.25 ppm as shown in the picture below:

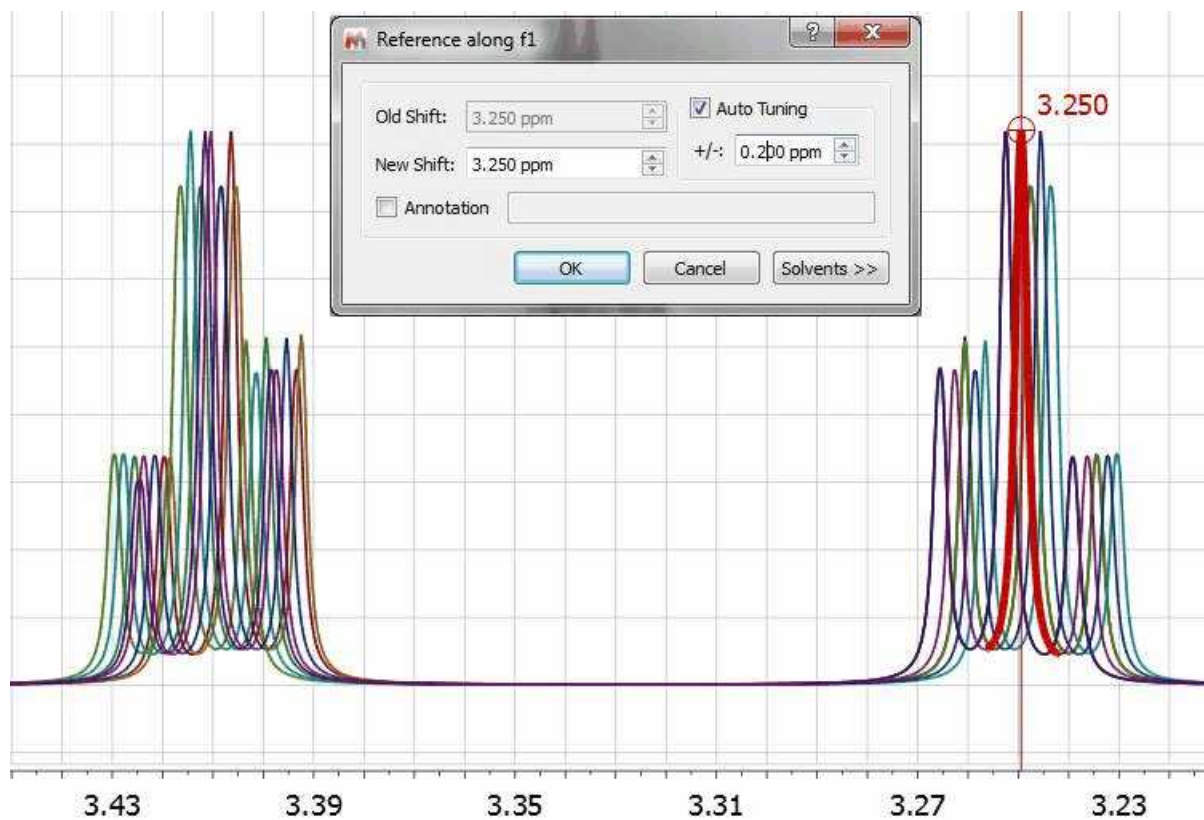

As expected, all peaks corresponding to the triplet at 3.25 get perfectly aligned, but the other multiplet remains misaligned:

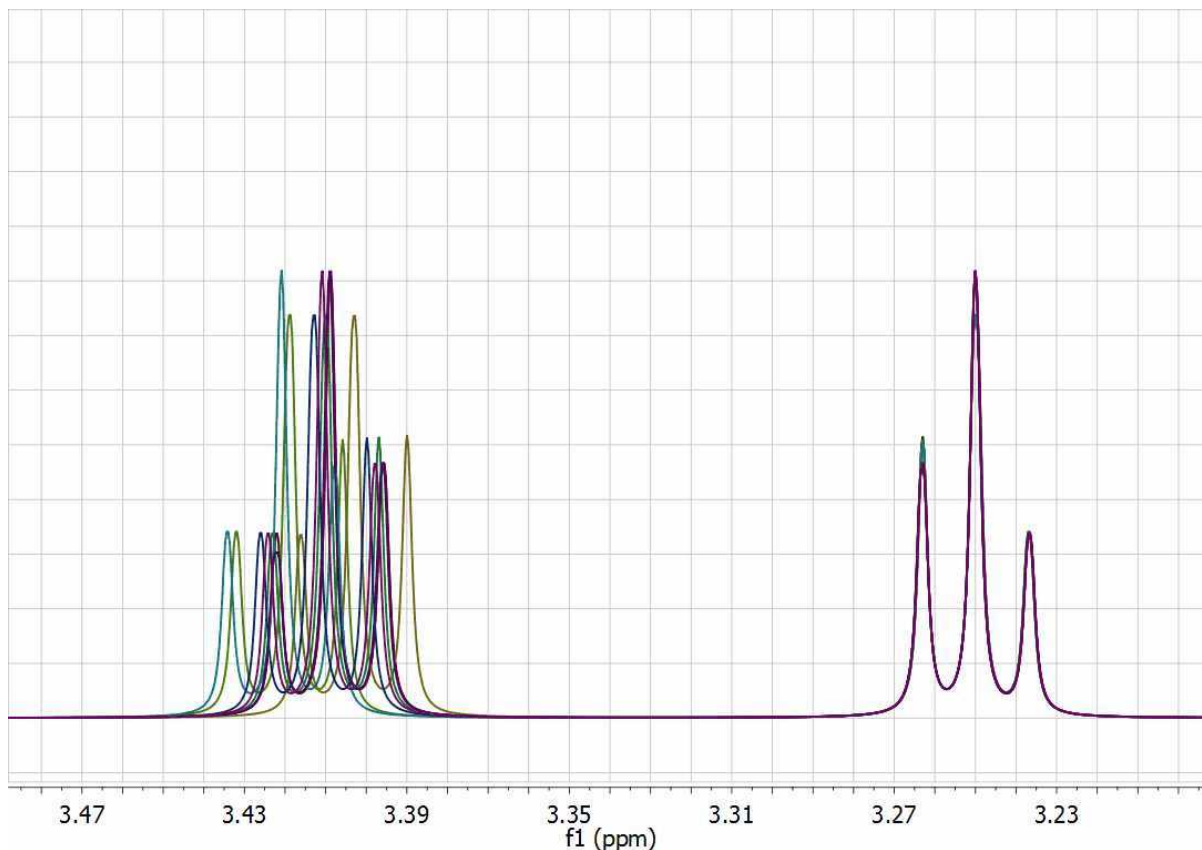

One could devise an extension to this global alignment procedure in which the same procedure is applied to different segments of the spectrum. In this particular case, one could select two different windows, one for each triplet and apply the same algorithm locally to each segment. However, having to manually select the chemical shift reference for each segment is not very practical and, in addition, relying only on the simple search of the maximum peak within each segment is not a very robust method for automatic alignment.

2) Fully automatic global spectral referencing

In the previous method, the user needs to select a peak as a reference for the alignment process, together with the window width for the auto-tuning parameter.

Mnova provides an alternative, fully automatic method which [aligns](#), **globally**, all spectra in a stack. This method uses one spectrum as a reference (the active spectrum) and then aligns all remaining spectra by maximizing the cross-correlation between the reference spectrum and the spectra to be aligned:

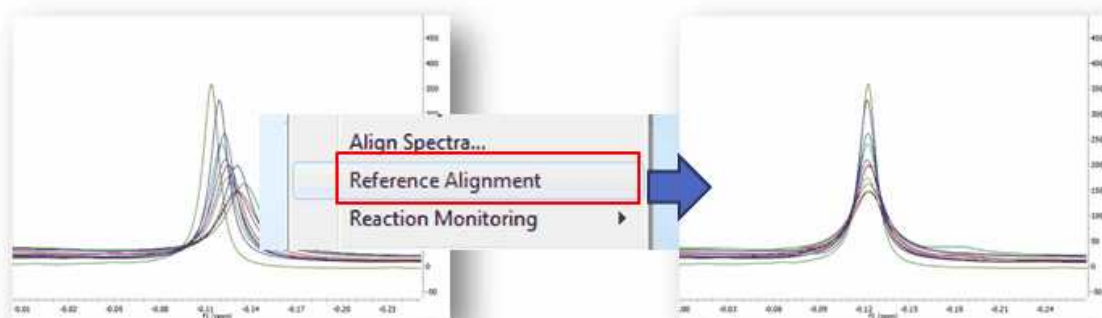

3) Spectral alignment (including global and regional-wise spectral alignment)

The magnitude of ***misalignments*** within a single sample may be ***nonlinear***, making it challenging to apply a simple alignment correction across an entire spectrum.

An example of this nonlinear misalignment is shown in the spectrum below (intensity map or bitmap plotting mode). It can be noticed that the peaks at about ca 11.6 ppm do not move whilst the peaks at higher field move very significantly.

It's evident that correcting the data using a single reference peak (or a global shift) is not sufficient:

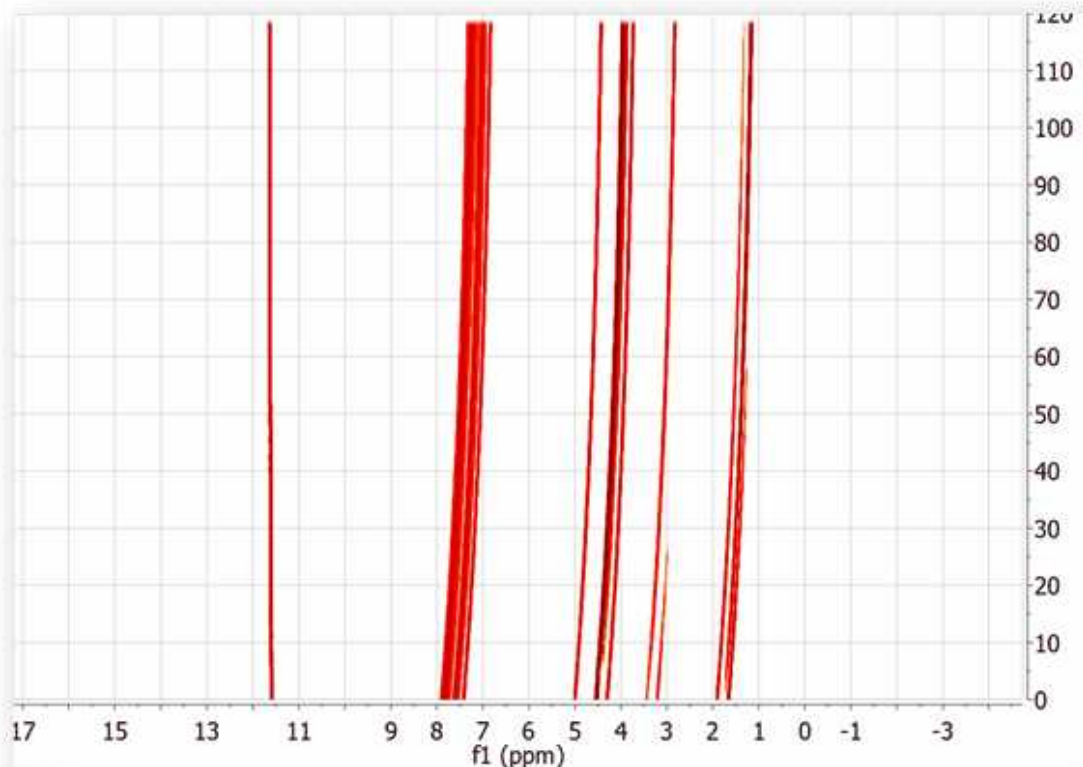

Resorting back to the synthetic data set used in the previous section, let's see a semi-automatic method designed specifically to align spectra having local chemical shift variations. From a practical point of view, the user needs to select the spectral regions to be aligned and then the program will automatically align those regions separately. The picture below shows the spectrum before alignment and the two selected regions (top) and the result obtained after applying the alignment algorithm (bottom):

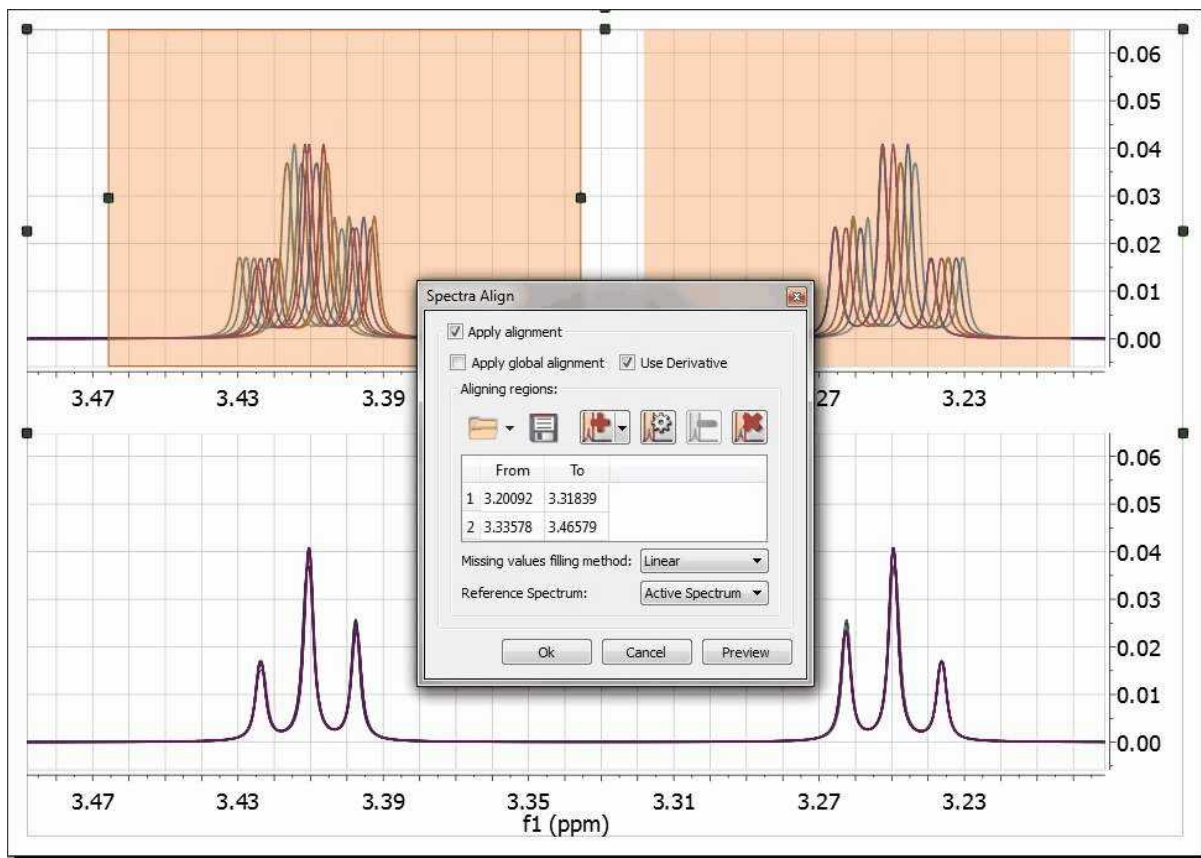

Mnova provides a powerful and flexible approach to dealing with misalignments based on a segment-wise peak alignment with the option to apply a global alignment as a pre-processing stage. The algorithm allows the user to select the boundary locations using an interactive display, but the process is also amenable to automation.

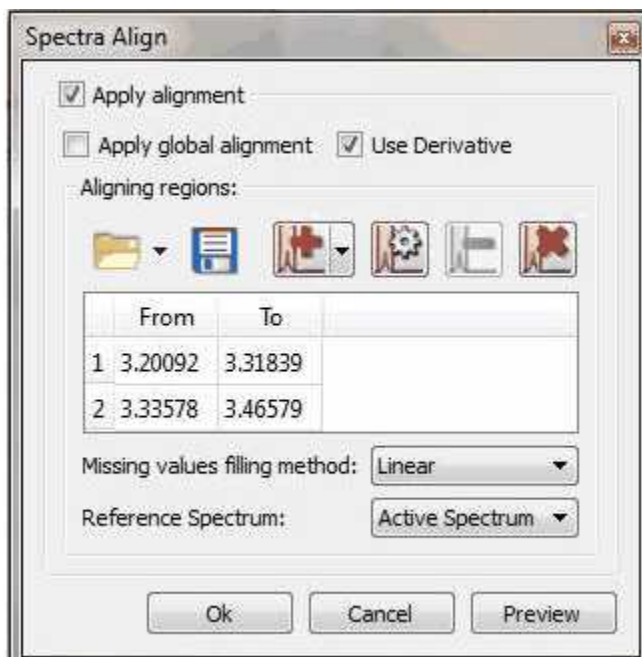

It will be possible to load and save alignment regions in XML format by using the applicable buttons in the dialog box above.

We have improved the traditional cross-correlation algorithm by working on the first **derivative** domain calculated using an improved Savitzky-Golay routine in which the order of the smoothing polynomial is automatically calculated. The idea is to minimize potential problems caused by baseline distortions or very broad peaks.

We have found this method to be very useful not only in the context of metabonomics, but also in the alignment of Reaction Monitoring data sets.

This comprehensive spectral alignment toolkit is available in Mnova in the Advance menu. It can work on the entire spectrum (Global Alignment) as well as on intervals of arbitrary length in sequence. Based on these options, different strategies can be employed.

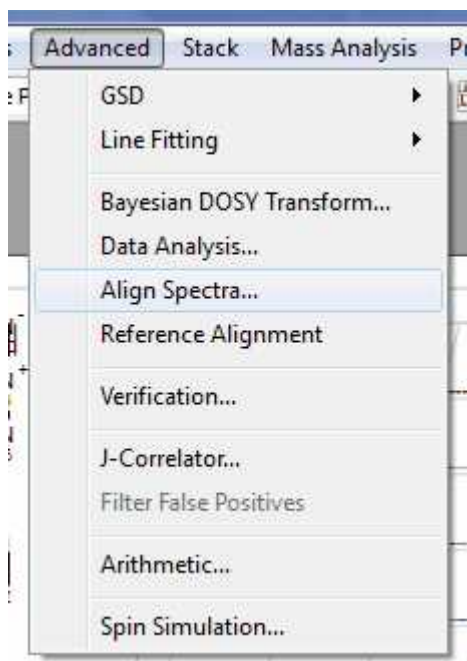

Two examples (strategies) will be shown below:

Strategy 1

Starting with raw spectrum (1), it is possible to perform a full-spectrum correction before the single intervals are aligned

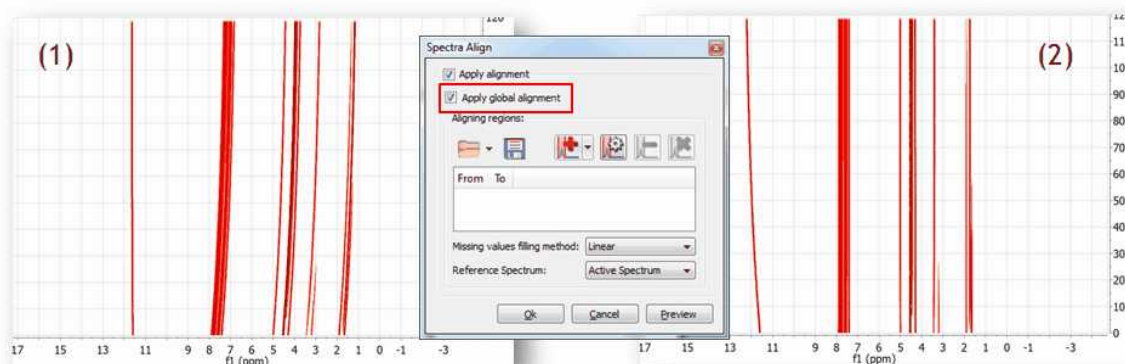

It can be appreciated that after applying the global alignment, most of the peaks in (2) are now properly aligned, except the peaks at the left which were previously aligned but after this operation get misaligned. This problem will be cured in the next step.

Strategy 2

A different, although analogous strategy, would consist in aligning two different spectral intervals separately without resorting to a global alignment as shown in (1). Note that the peaks in the interval on the left are already well aligned.

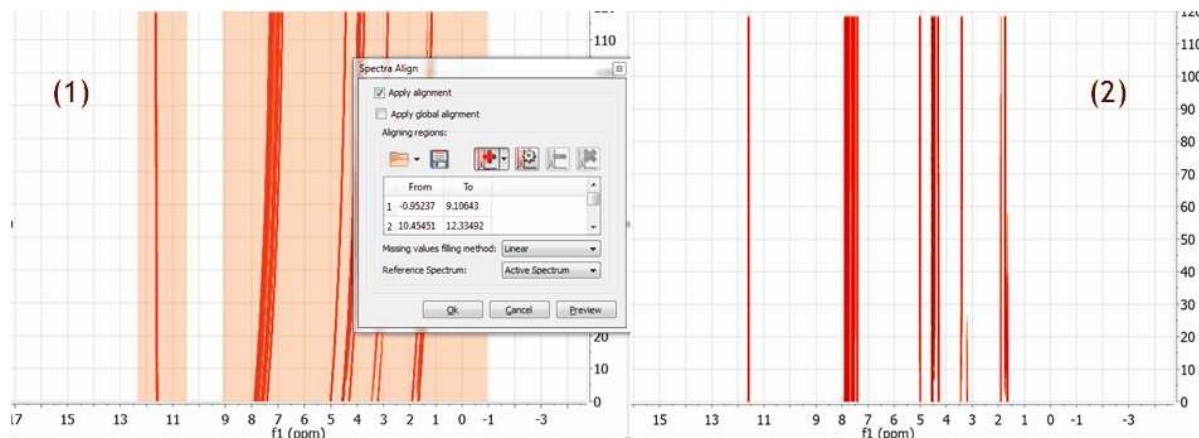

Figure (2) shows the final result after the two intervals have been aligned. It's completely equivalent to the result obtained with Strategy 1

[See also our blog](#)

10.6 J-Correlator

J-Correlator (Not available in Mnova Lite): is a new method for detecting spin connectivities in ^1H NMR spectra. The main goal of this method is to convert a 1D spectrum into a 2D-like plot in which it is easy to correlate multiplets containing the same **splitting**. Its main purpose is to rule out couplings between multiplets. It is suitable for human inspection.

The basic idea is to generate a 2D plot from a ^1H NMR spectrum in such a way that the horizontal dimension conveys the chemical shifts whereas the vertical one represents the separation between peaks in the spectrum (**splittings** from now on). Basically, it is a special kind of 2D ^1H - D experiment (where D = splitting).

Just load your ^1H NMR spectrum and follow the menu 'Advanced/J Correlator' to display the J

Correlation dialog box to select the desired algorithm and display options:



As usual, a picture is worth a thousand words:

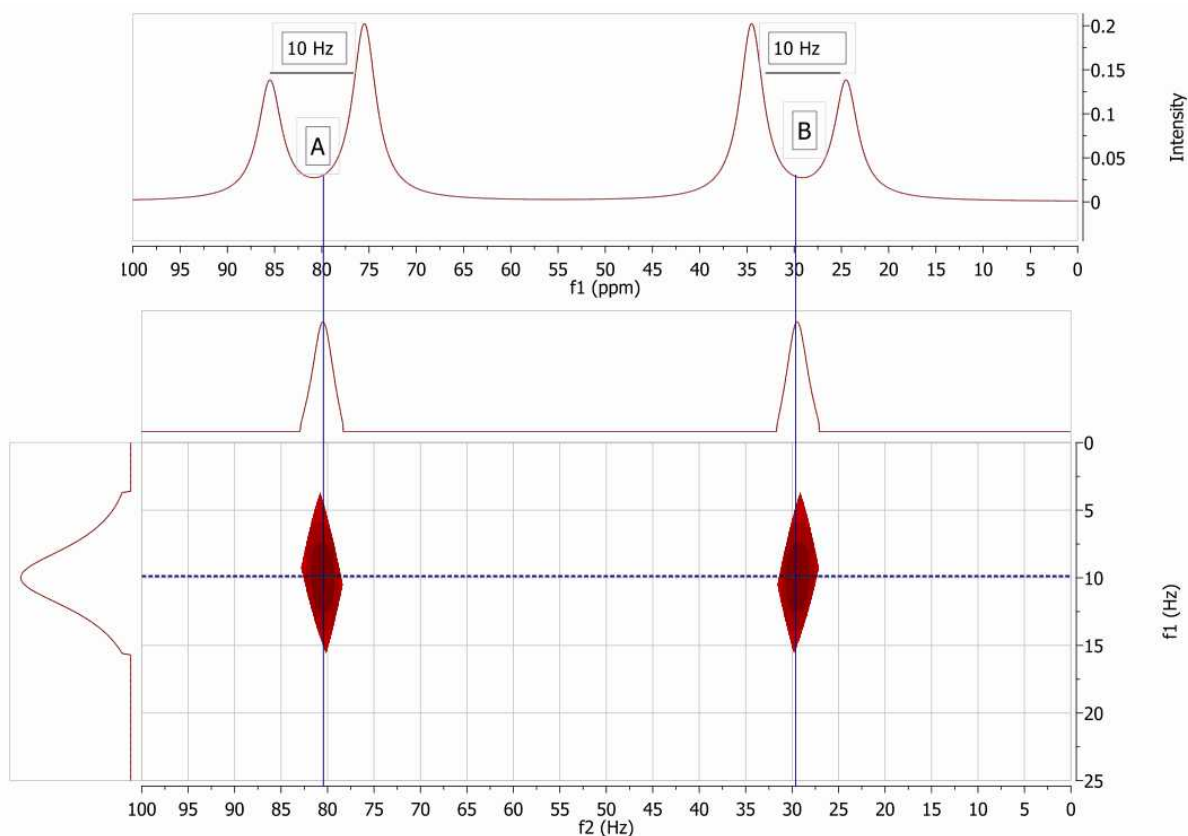

In this figure we have simulated 1D spectrum with two coupled spins, $A = 80$ Hz and $B = 30$ Hz. $JAB = 10$ Hz.

In the new 2D plot (JCorr from now on) we can see two cross peaks at the positions of A and B respectively and at the same d-trace (vertical dimension or splitting dimension).

It's very important to remember that what we see in the JCor plot are just splittings, not Coupling Constants, even though in some cases these splittings can coincide with coupling constants.

10.7 Arithmetic

Arithmetic (Not available in Mnova Lite):

This feature is used to carry out arithmetic operations with 'fid's or processed spectra. Typically, you will use the arithmetic module implemented in MestReNova to sum 'fid's' acquired under the same measurement conditions in order to improve the signal-to-noise ratio.

This tool is also very useful to **remove impurities** or solvent signals from a spectrum, to **analyze DEPT experiments**. This feature will be enhanced in the oncoming versions of the software to be able to **subtract FIDs of Selective Experiments** (such as NOE or ROE).

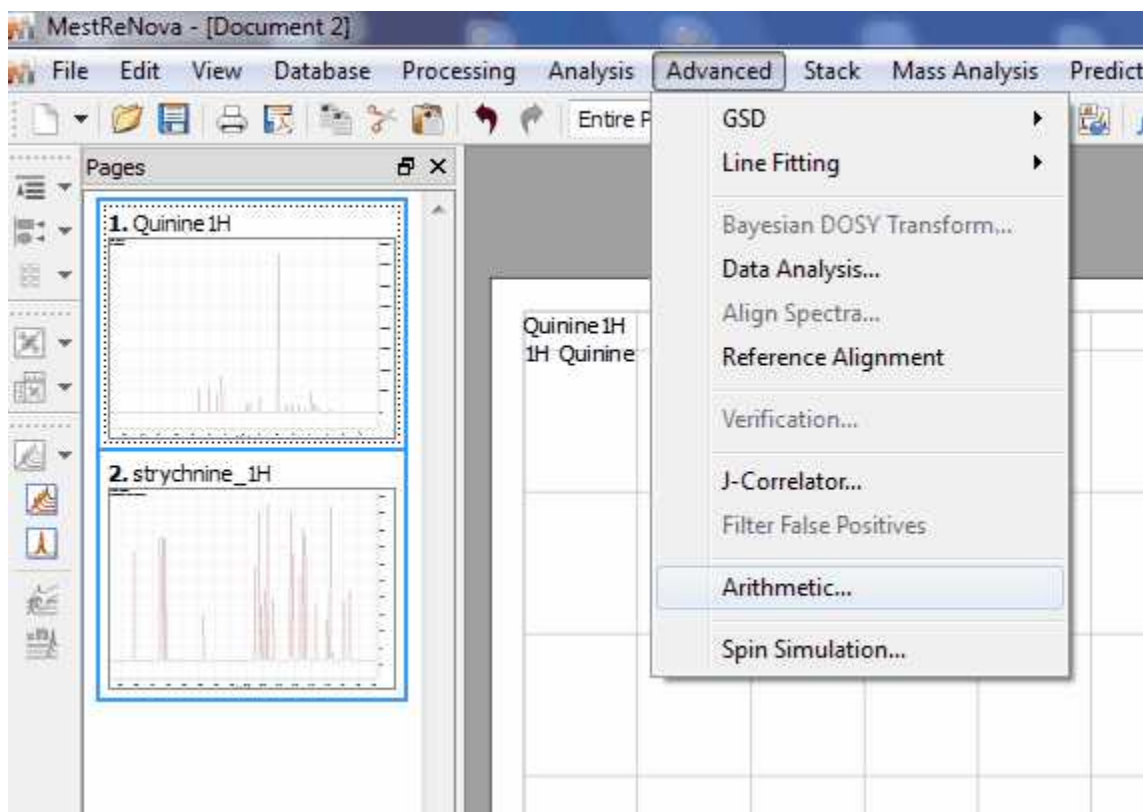

How to sum or subtract spectra?

Application of Linear Combinations (sums, subtraction and multiplication) to spectra in the MestReNova interface is extremely simple. Just select the desired spectra (make sure they are acquired under same conditions) on the Page Navigator (by holding down 'CTRL key' or 'Cmd key' while clicking on each spectrum) and follow the menu 'Advanced/Arithmetic':

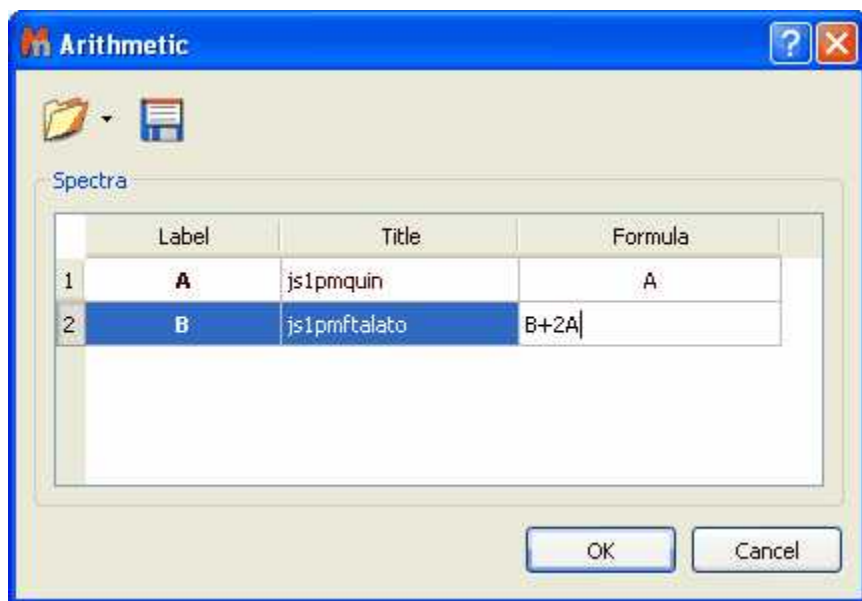

This will display the 'Arithmetic' dialog box on screen. In this example, we want to add two times spectrum A to spectrum B, so we shall type the formula 'B+2A' in the applicable cell.



The 'Save Formulas' icon  will allow the user to save formulas, which can then be loaded by using the 'Load Formulas' icon .

On pressing 'OK', the result is a new spectrum which will consist of the sum of spectrum B plus two times spectrum A.

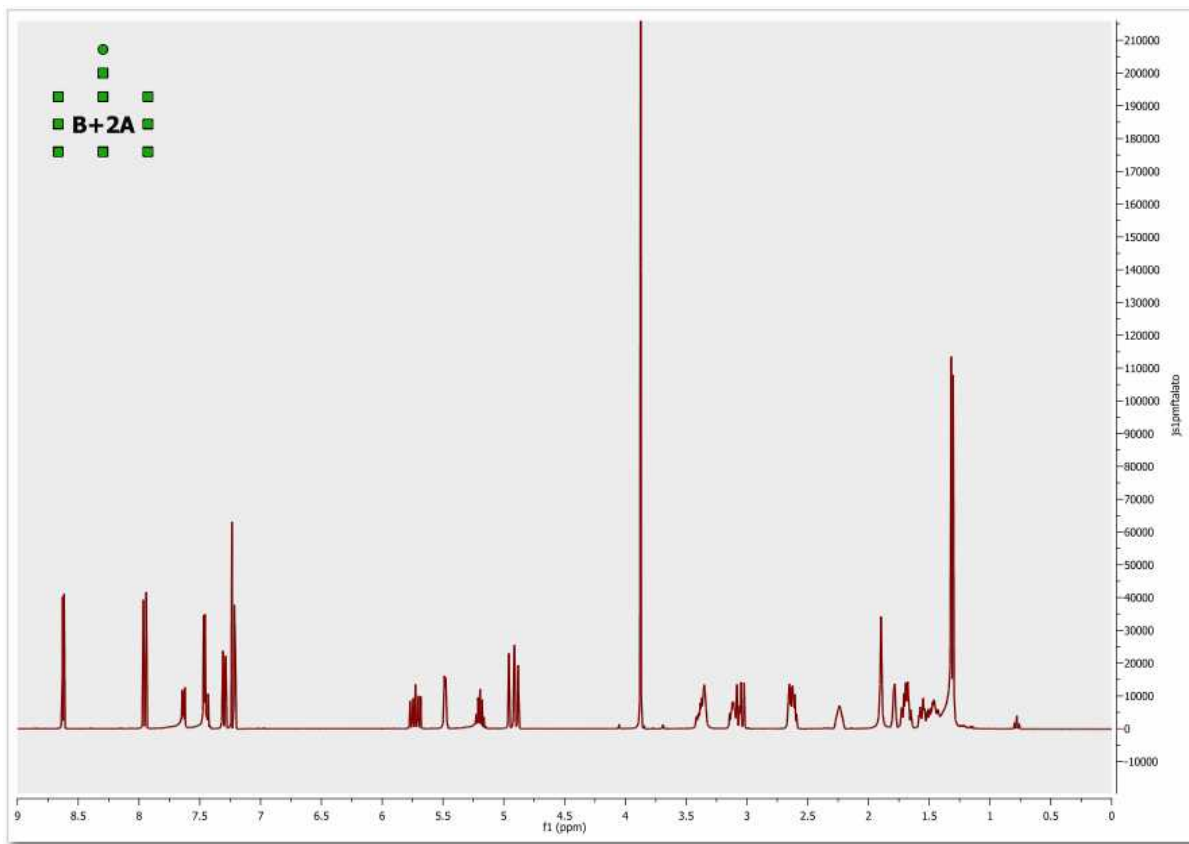

It is also possible to subtract spectra, but in this case it is important that the user calculates the intensity ratio of both spectra. For example, in this spectrum we have a sample contaminated with a solvent.

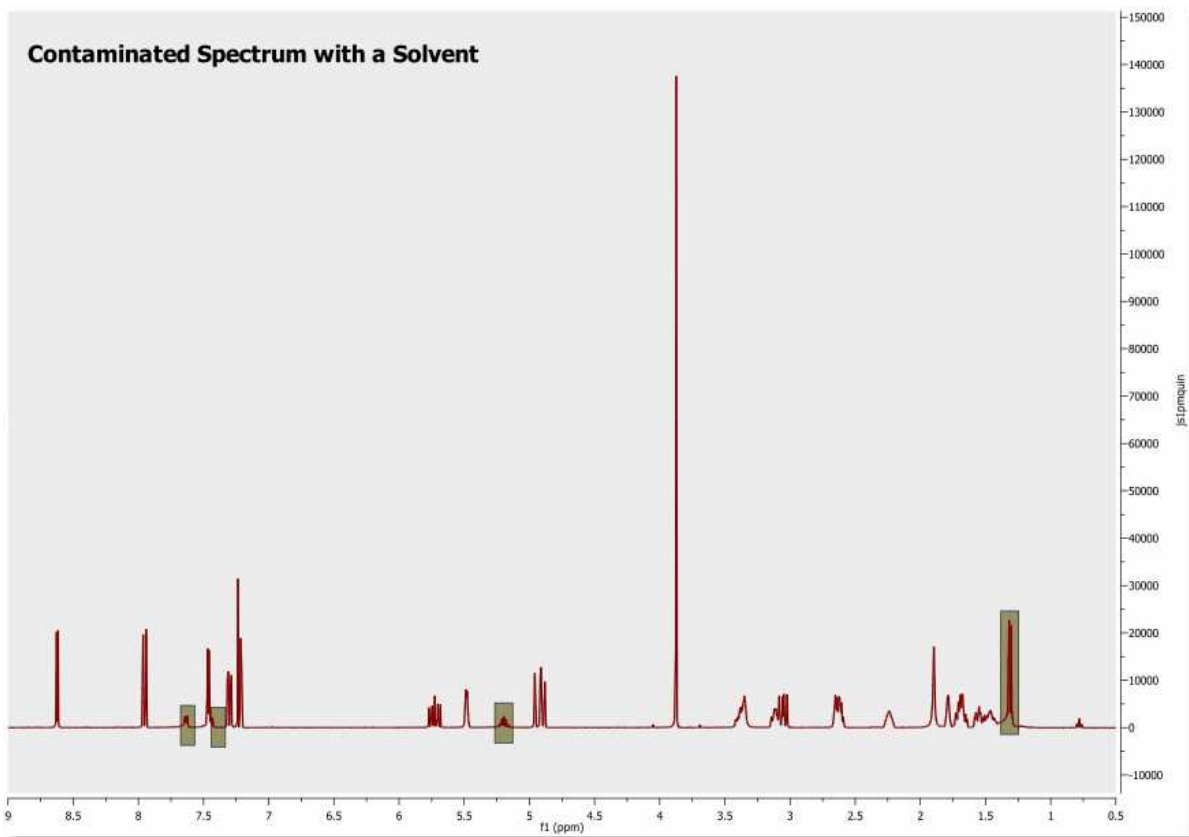

Whilst the spectrum below corresponds to the solvent which we need to eliminate from the sample.

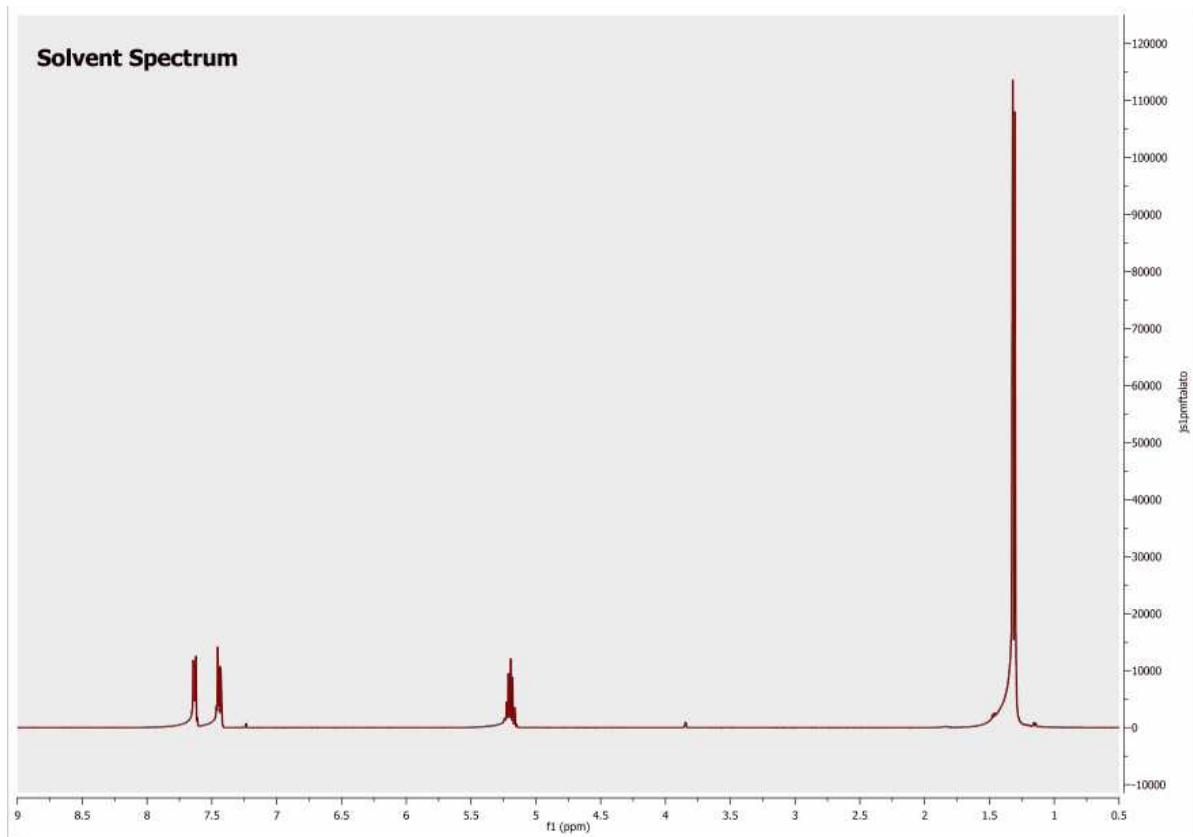

To successfully carry out the subtraction, we need to calculate the intensity ratio between the contaminated spectrum and the solvent spectrum. To obtain this ratio we can measure the intensity of a signal present in both spectra (by applying the command 'Peak by peak' and getting the result on the applicable table). For example, we measure the intensity of the singlet which appears at 1.32 ppm. For the first spectrum, we obtain an intensity of 22617 and for the second, 115031, indicating the intensity ratio to be 1/5, or 0.2.

Typing the formula '**A-0.2B**' (or '**A-0.2*B**') in the 'Arithmetic' dialog box, we shall obtain the spectrum below, where the solvent signals have been removed:

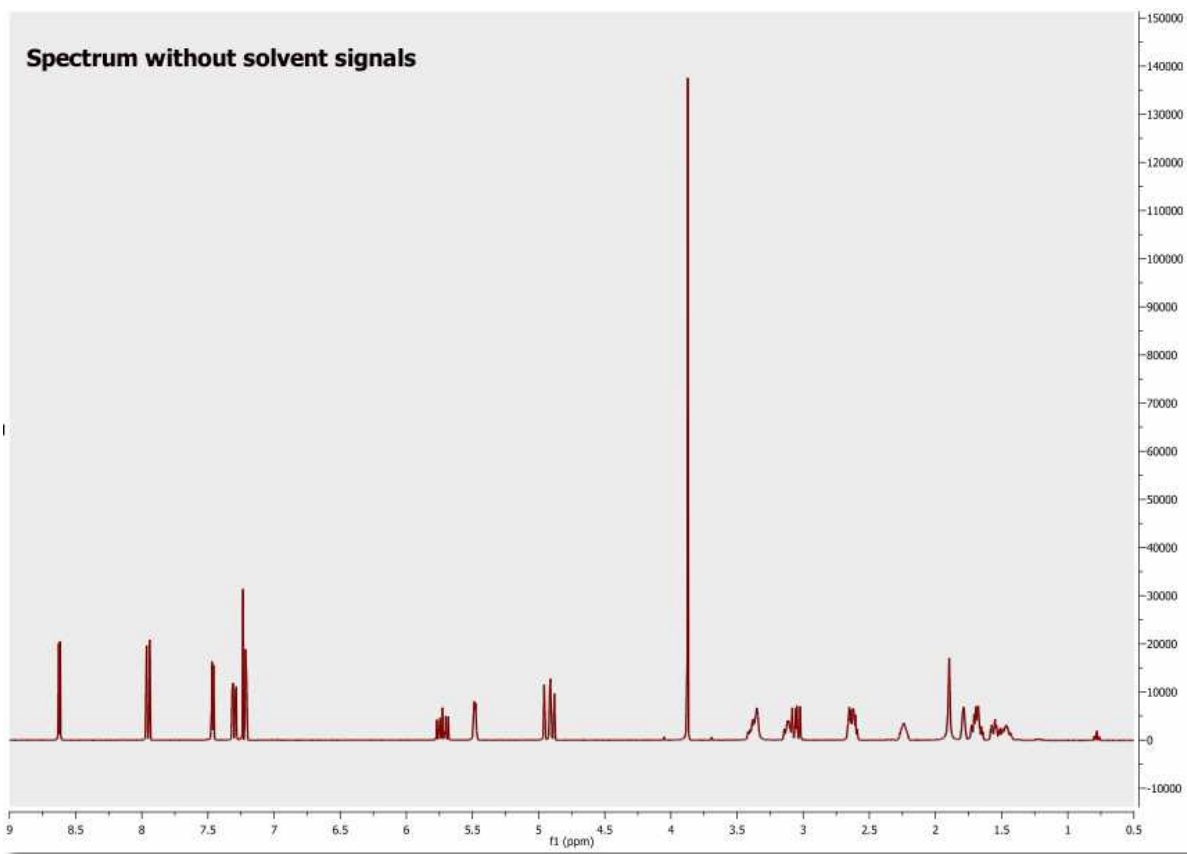

Arithmetic and Covariance NMR

2D NMR spectra are simply 2D matrices (Note: these matrices can be real, complex or hypercomplex, but for the sake of simplicity, we will consider real matrices only) which can be subject to standard matrix algebra operations. You can read the [Covariance NMR](#) chapter where it is shown how Indirect and Direct Covariance NMR can be applied by proper matrix algebra. These methods are incorporated in Mnova as a dedicated module which also makes the filtering of spurious resonances possible. In order to show you that Covariance NMR actually involves these matrix operations, you can use Mnova's powerful Arithmetic module which we have recently completed. This module has been designed in such a way that it operates as a simple spectral calculator. You enter the equation which the program parses and produces the expected result. For example, if we have a HSQC-TOCSY spectrum (**A**), we can enter the Indirect Covariance formula like this:

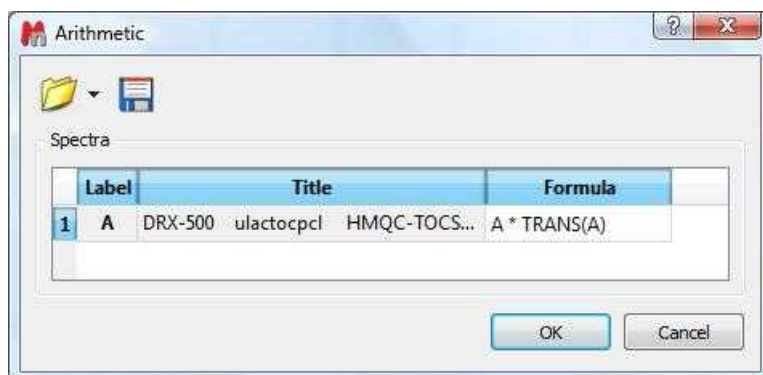

Where **A** corresponds to the real part of the original spectrum and **TRANS** indicates the transpose operation. This operation will produce the (unnormalized) Covariance NMR spectrum, in this case the ^{13}C - ^{13}C correlation spectrum. Of course, in order to better approximate the covariance spectrum to the applicable standard 2D FT counterpart, it's necessary to calculate the square-root using, once more, matrix algebra. This is again very simple with our arithmetic module by just adding the square root operation (**SQRT**) into the equation:

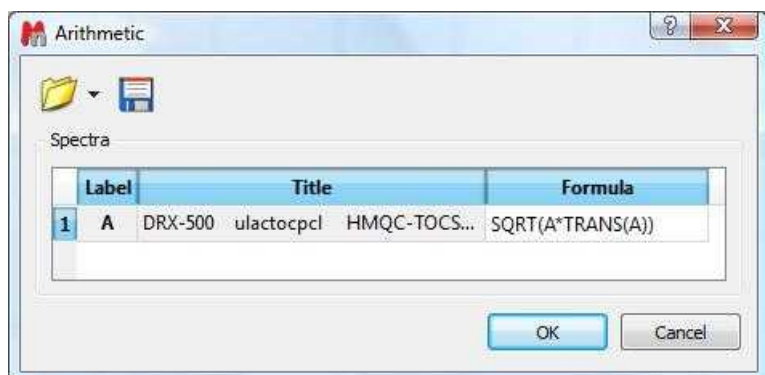

This arithmetic module is not restricted to matrix operations within a single spectrum. We can freely combine as many spectra as we want. For instance, if we have, in the one hand a COSY spectrum and in the other a HSQC spectrum, we can combine both in an analogous way so that the indirect covariance NMR spectrum yields a HSQC-COSY 2D spectrum.

10.8 Spin Simulation

This module of MestReNova is an efficient simulator for high resolution NMR spectra which can be used by following the menu 'View/Panels/Spin Simulation (or Advanced/Spin Simulation)' which will display the applicable dialog box:

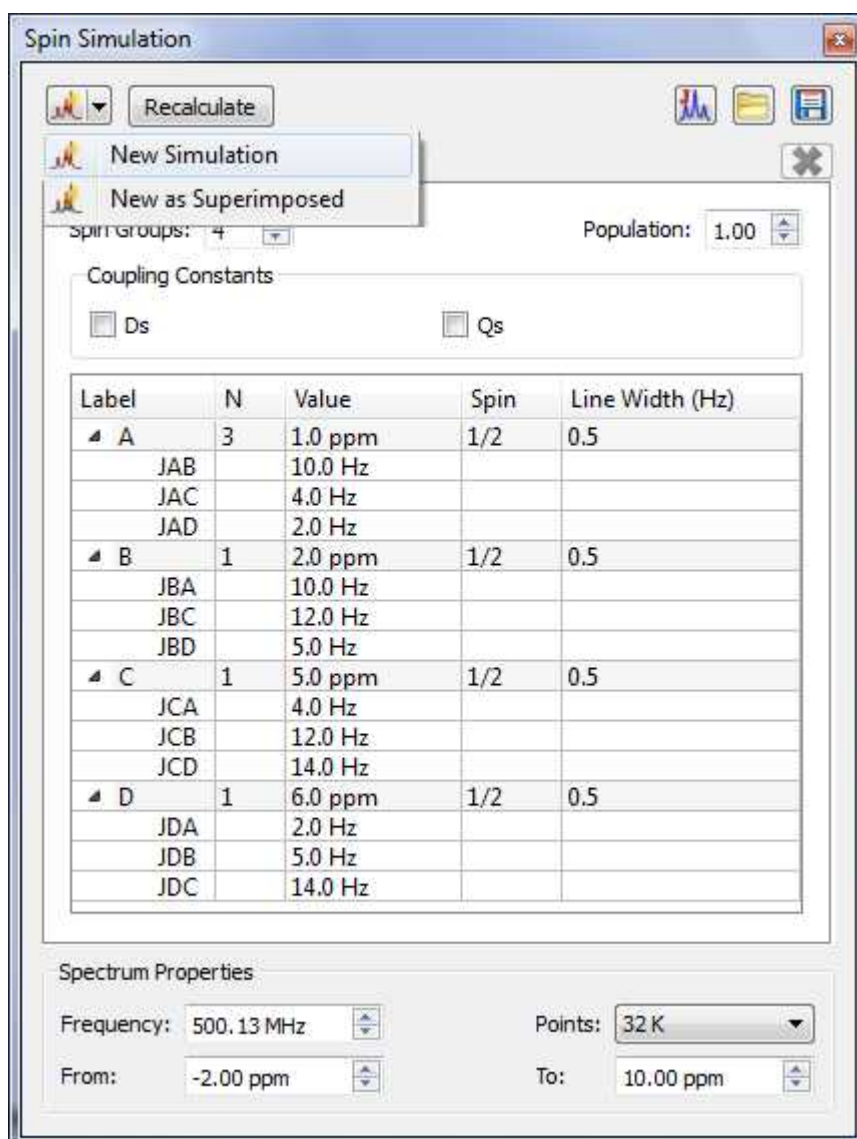

Once there, we can easily simulate a spectrum by entering the desired values. For example, imagine 3 protons (3 spins Groups) called A, B and C, with chemical shifts 1, 5 and 7 ppm respectively. Their coupling constants were $J(AB) = 3\text{Hz}$, $J(BC) = 5.5\text{Hz}$ and $J(CA) = 3.4\text{Hz}$. Finally select the number of points and the spectral limits and click on the 'New Simulation' button to generate the corresponding spectrum:

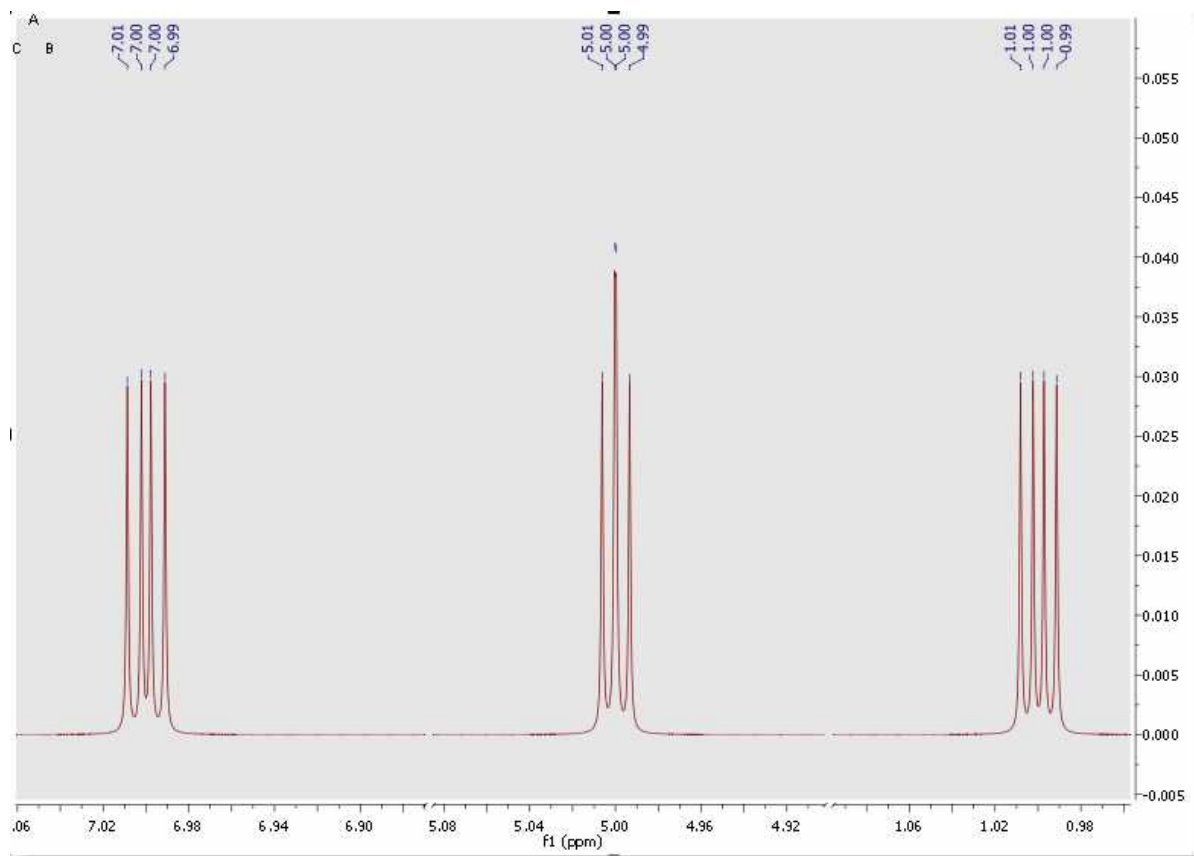

Once you have simulated the spectrum, you can easily modify any value in the table and obtain the new spectrum by clicking on the 'Recalculate' button. It will be also possible to introduce 'Dipolar' or 'Quadrupolar' coupling constants and to change the 'number of nuclei', 'Spin' and the 'Line Width' values just by clicking and entering the desired values on the corresponding boxes. Finally click on the 'Recalculate' button to update the changes in the spectrum.

It will be also possible to change the chemical shift of any signal of the spin-simulated spectrum, just by clicking&dragging the assignment label:

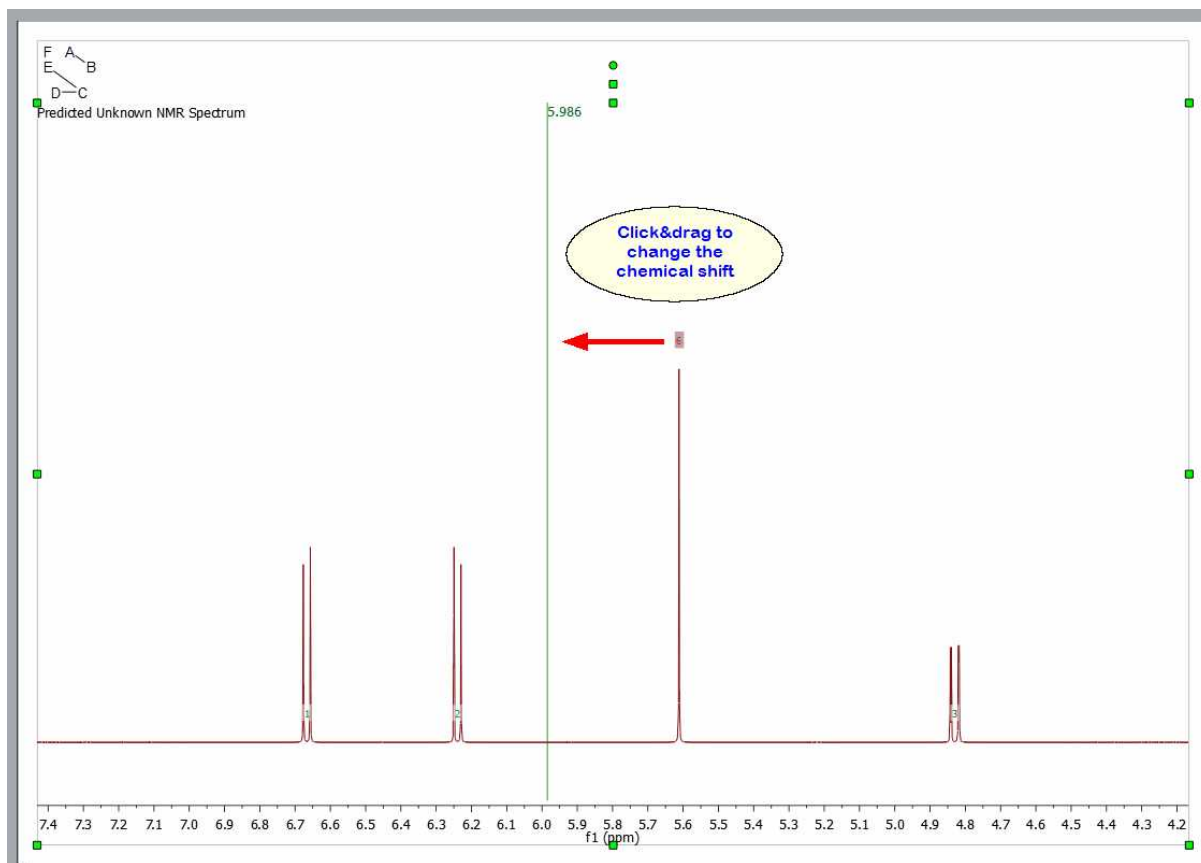

Traditionally, Spin Simulation algorithms were limited to 11-12 magnetic nonequivalent coupled particles. However, this is completely insufficient to tackle the 'small molecules' of today. Consequently, simulation nowadays calls for brand new approximate algorithms involving, for example, fragmentation techniques.

Mnova SpinSimulation toolkit includes such sophisticated fragmentation algorithms which makes it possible the simulation of any spin system regardless of its size.

It will be possible to 'Load/Save' the spin systems (in XML format) just by clicking on the applicable buttons of the panel .

You can see below the simulated spectrum of the 'ortho-dichlorobenzene'; which is a AA'BB' system:

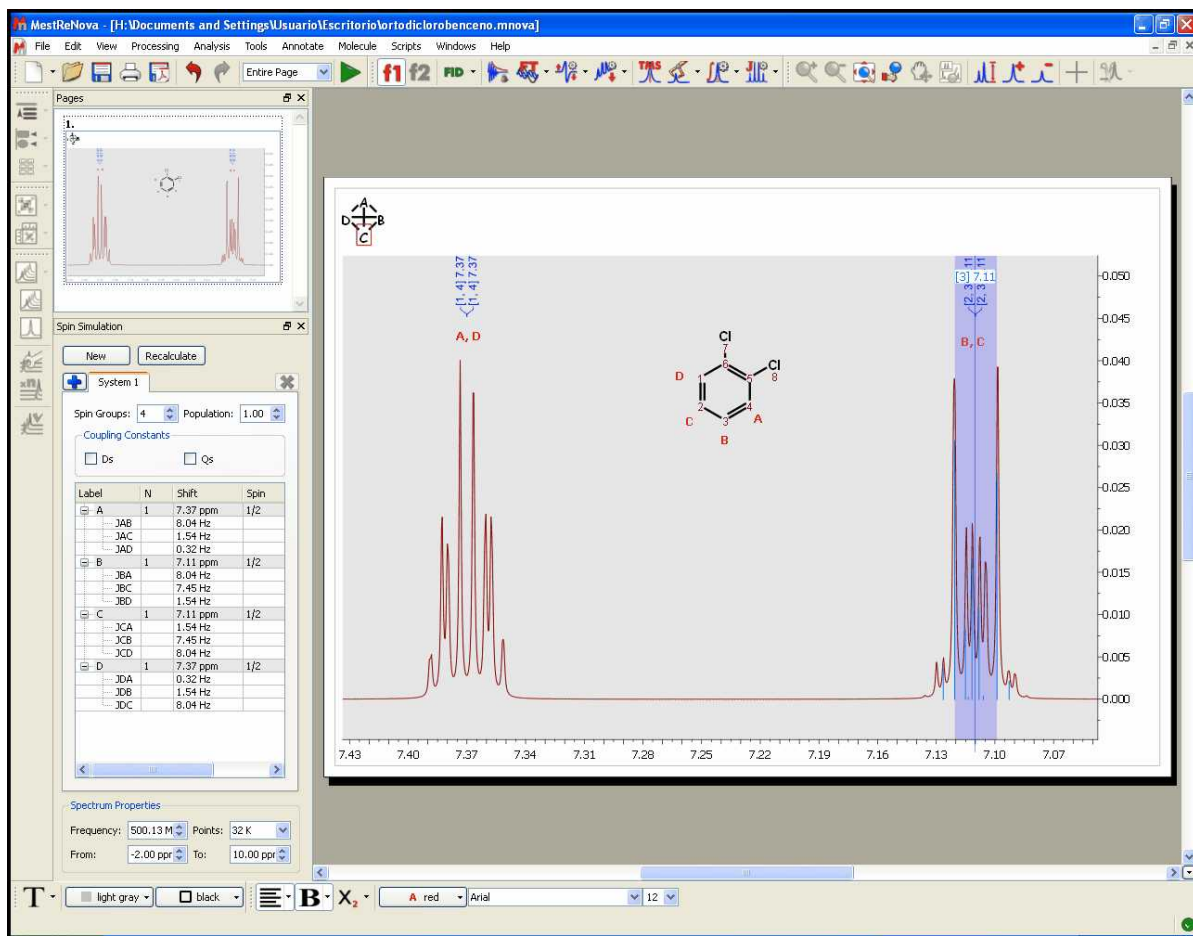

How can I simulate an A3BXY system?

Here you can see an example of an A3BXY system:

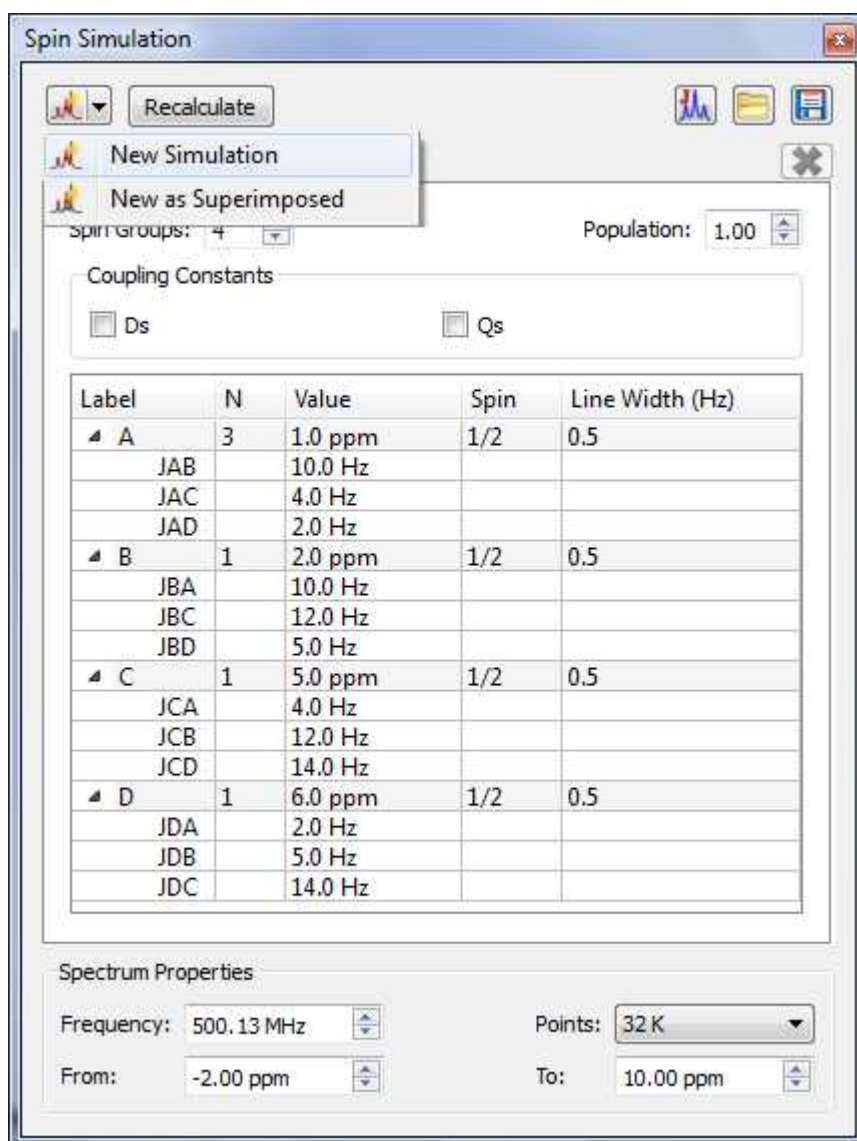

To get the table above just follow this procedure:

1. Firstly, create a system with 4 spin groups. Please bear in mind that A3 is a unique spin group with 3 magnetic equivalent spins, so you will need to type N=3 in the label A..
2. Then, type the desired values for the other nuclei (B, C, D) with N = 1 for all of them (enter also the desired chemical shift value). Please bear in mind that Mnova does not need to know if the coupling is strong or weak, because Mnova makes the quantic calculations by using a rigorous method taking into account the chemical shift and the coupling constants
3. Once you have entered all the values and selected the Larmor Frequency and number of digital points, Linewidth for each nuclei, etc..., just click on the 'New' button to get the synthesized spectrum.

How can I add new systems?

It is also possible to add several systems just by clicking on the 'Add System' button . A new system will be a fragment of the molecule that can be simulated separately since its protons do not interact with the rest. In other words, a set of nuclei that are related through their coupling constants.

Once you have added a new system, you can change the population of the system by using the 'Population' edit box.

As an example, consider the case of a small molecule, ethyl acrylate $\text{CH}_2\text{CHCOOC}_2\text{H}_5$

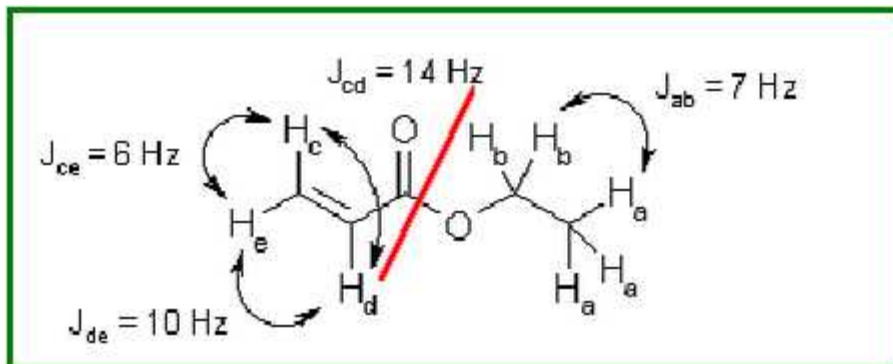

As you can see, a standard simulation of the ^1H -NMR spectrum of this molecule would require eight frequencies to be introduced, one for each proton. Moreover, you should introduce nine coupling constants as well. However, even a brief study of this spin system suggests us a more elegant solution.

Why not treat this spin system as two 'subsystems'? One 'subsystem', corresponding to the ethyl group, is composed of five protons with only two distinctive frequencies labeled a (the methyl group) and b (the methylene group), and only one coupling constant, J_{ab} . Other 'subsystem' is composed of the three remaining protons (those of the vinyl group), with three frequencies, c, d and e, and three coupling constants, J_{cd} , J_{ce} and J_{de} . This decomposition of the spin system in two subsystems is possible because they are not connected in any way. The decomposition of a spin system into subsystems can be carried out in many molecules, and is, for example, the conceptual basis of the NMR spectroscopic data tables.

You can see below, the synthesized spectrum of the ethyl acrylate; after having created two different systems; system A (vinyl protons) in red, and system B (ethyl group) in green:

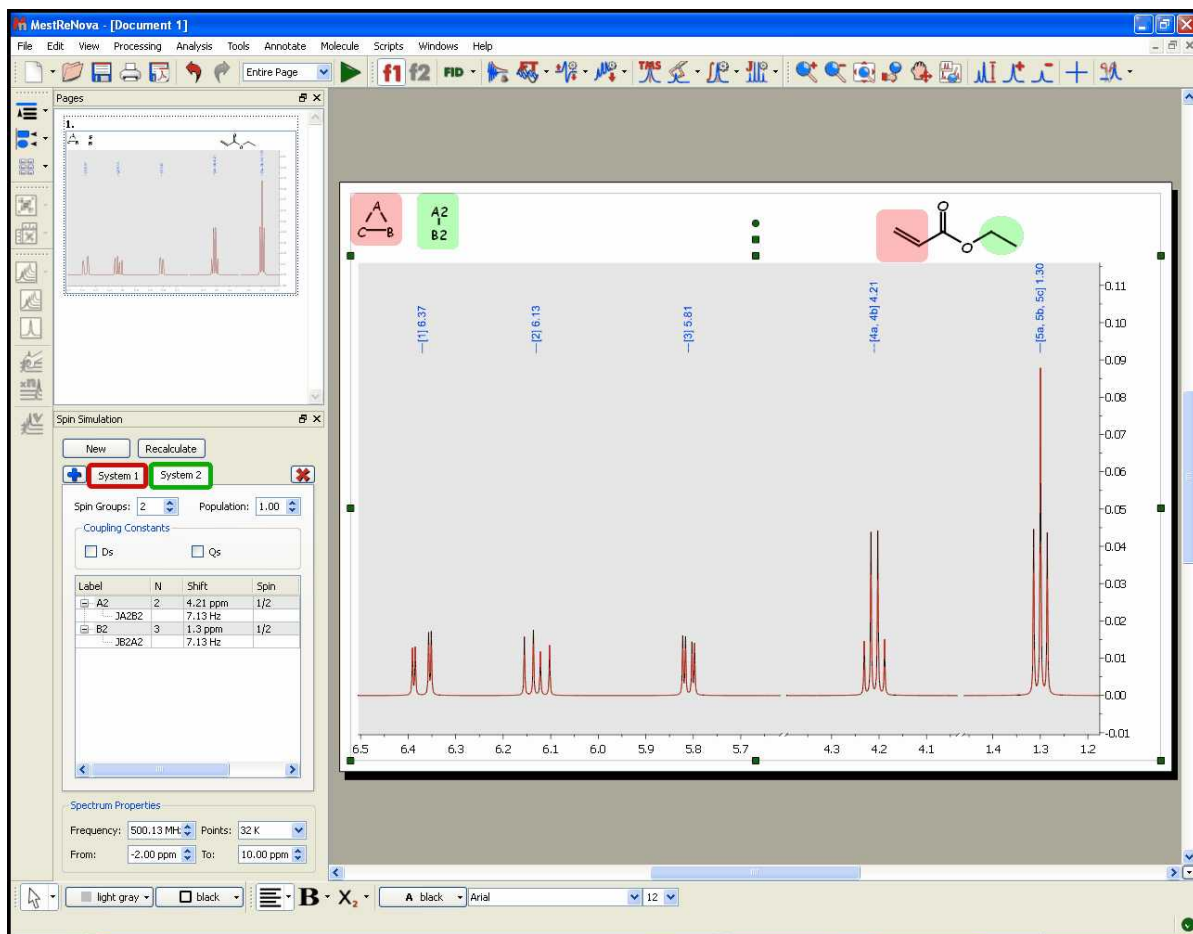

This decomposition method represents a great advance in terms of calculation speed, because the complexity of the calculation grows exponentially with the number of spins (nuclei) considered. However, we can perform even faster calculations and achieve greater flexibility going one step further.

Why not introduce only five frequencies, and tell the program how many protons correspond to each frequency? The introduction of magnetic equivalence allows the calculation to be performed using five spin groups, labeled from a to e, with their corresponding frequencies. The two first spin groups, a and b, have three and two protons respectively, while the other three spin groups have only one proton each. Of course, we need then only four coupling constants, J_{ab} , J_{cd} , J_{ce} and J_{de} . This process can be carried out in many molecules, and is more intuitive than the classical one.

Here you can see another example comparing an experimental dataset with the simulated one:

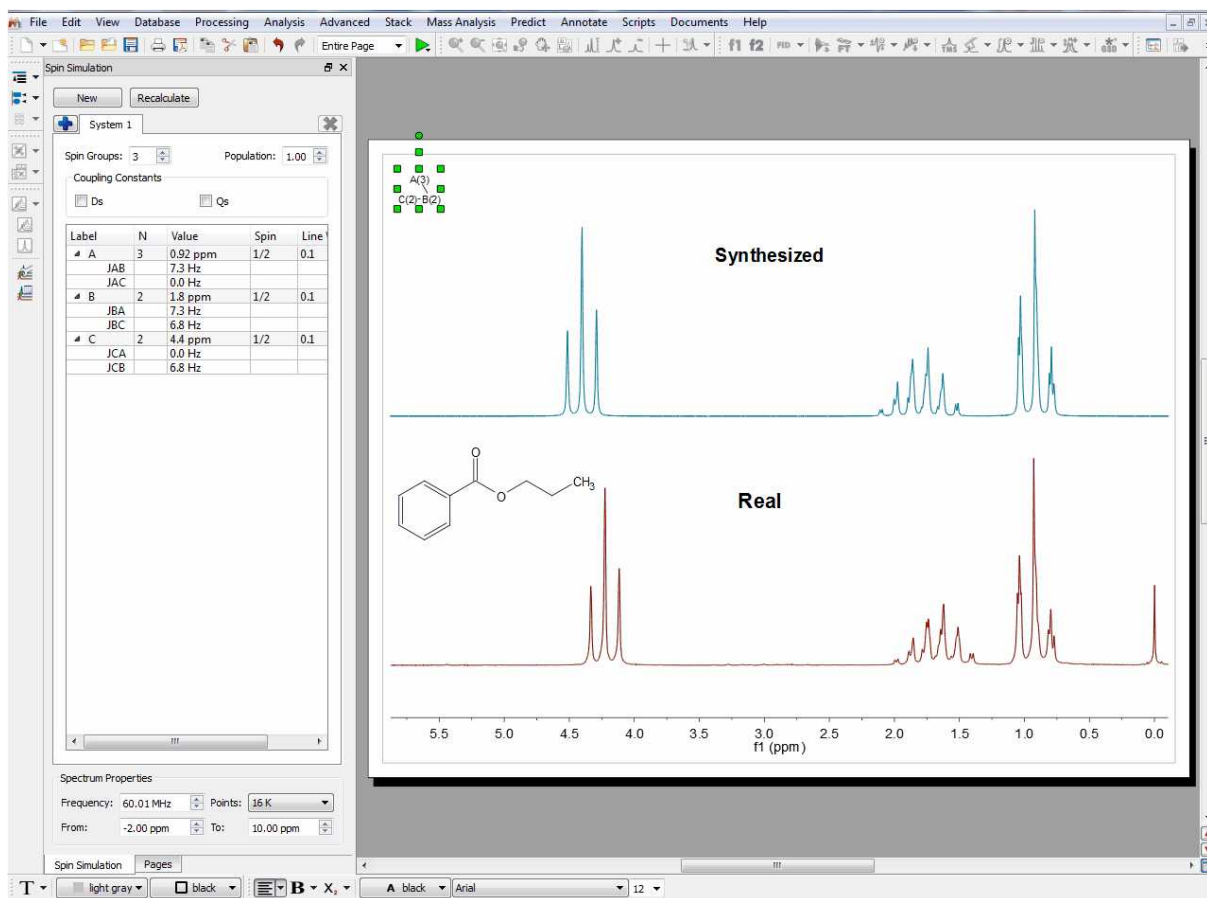

Simulating a spectrum by importing a XML file

It will be also possible to synthesize a spectrum, just by loading a XML file with information about the multiplets. [Here you can see an example](#). Loading the XML file into Mnova, will generate the spectrum below:

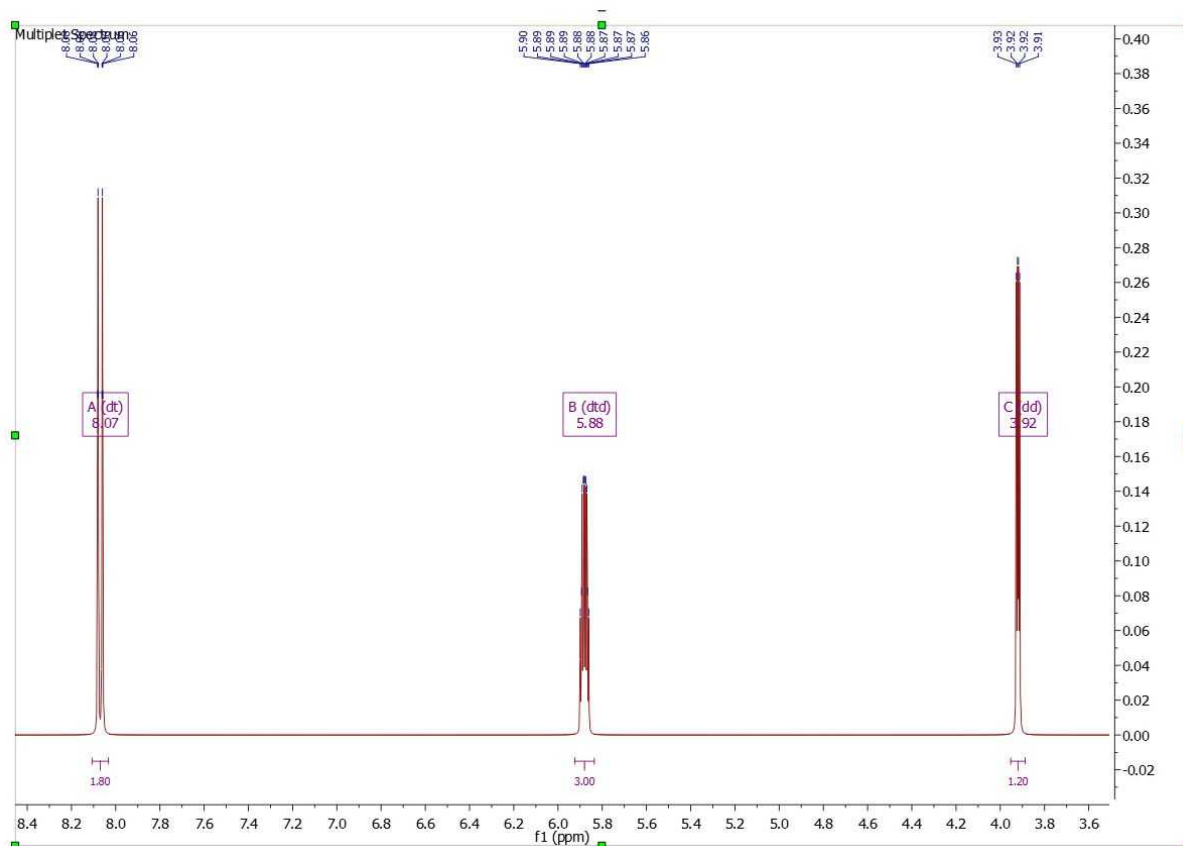

Simulating a spectrum from the Multiplet Analysis

The table of multiplets can be used for the simulation of the synthetic spectrum. To do it just run a multiplet analysis on a experimental spectrum (make the necessary corrections if it is needed) and open the 'Spin Simulation' panel to click on the 'Get From Multiplets' button to populate the table with chemical shift and coupling constants values. Finally click on the 'New Simulation' button (or 'New as superimposed' if you want to get the experimental and the synthetic spectra overlaid).

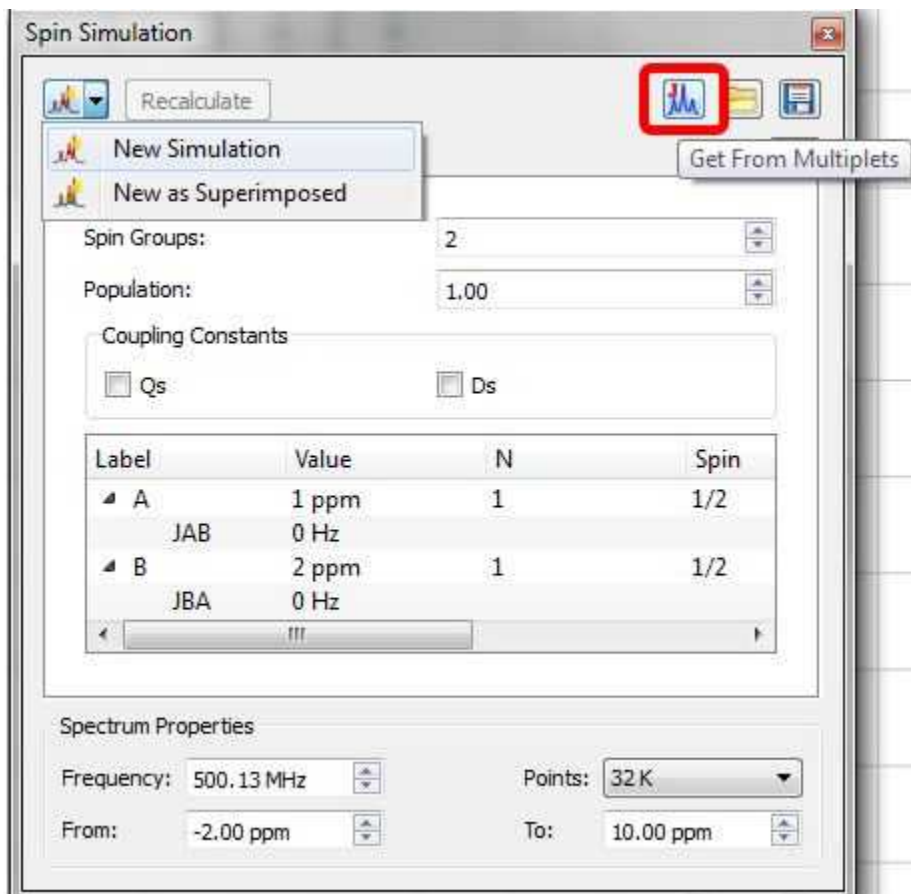

Part



XI

11 qNMR

qNMR is the “gold standard” of compound quantification and has found many uses and applications. qNMR stands for “quantitative NMR”, and refers to the use of NMR to determine the concentration of one or more chemical species in solution.

The area of an NMR signal is directly proportional to its concentration, and this “response” will be the same for all molecules.

And this is also what sets qNMR apart from almost all other metrological techniques used to quantify compounds. Each suffers with problems such as compound-specific response factors (UV), chemical considerations (NCLD), or relative volatility (ELSD). The qNMR method only requires that (a) the sample dissolves completely in a (normally fully deuterated) solvent, and (b) it contains NMR-active nuclides – and that some care and attention is paid to data collection and processing.

Our new module provides a mechanism to quantify compounds that is:

- Accurate
- Versatile
- Automatic

The basics of qNMR require simply the *Absolute Integral* per nuclide for one or more spectral regions, and a factor to *convert* this to concentration.

We have designed a competent, flexible, and sophisticated program for quantitation by NMR. It may be run fully automatically and thereby incorporated into automated procedures and combined to streamline processes such as compound [Verification](#) and quantitation.

This new feature needs its own license and it is located under the Advanced menu of Mnova.

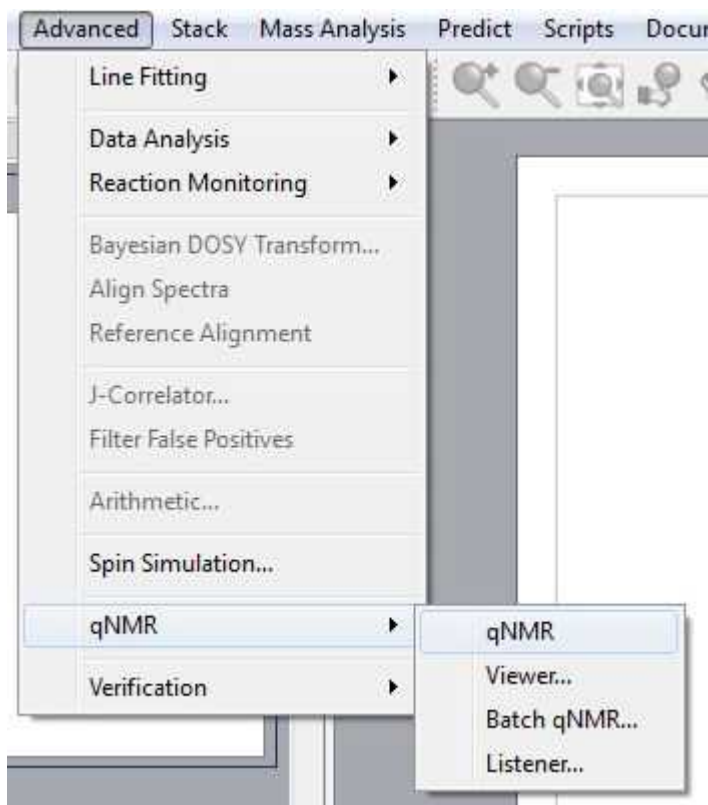

You will need to install the qNMR plugin apart, by following the menu 'Edit/Advanced Plugins' and clicking on the 'blue plus' button.

Please visit our blog about qNMR:
<http://mestrelab.com/blog/topic/qnmr/>

11.1 qNMR Workflow

Generally, the workflow will be:

- Determine multiplets
- Run the script and select the qNMR variables
- The software will choose the multiplets to include
- Report

So first of all, we will load a ^1H NMR spectrum and apply the necessary processing. (Depending on the level of accuracy required, you must pay attention to the number of data points used for the FT (typically 64K) and to apply a phase correction. Sometimes a baseline correction could be also needed. If necessary (e.g., solvent saturation was used), [blind regions](#) should be used to mask these spectral regions).

In the example shown below (which you can download from [here](#)), we have just loaded the dataset and applied an 'automatic multiplet analysis':

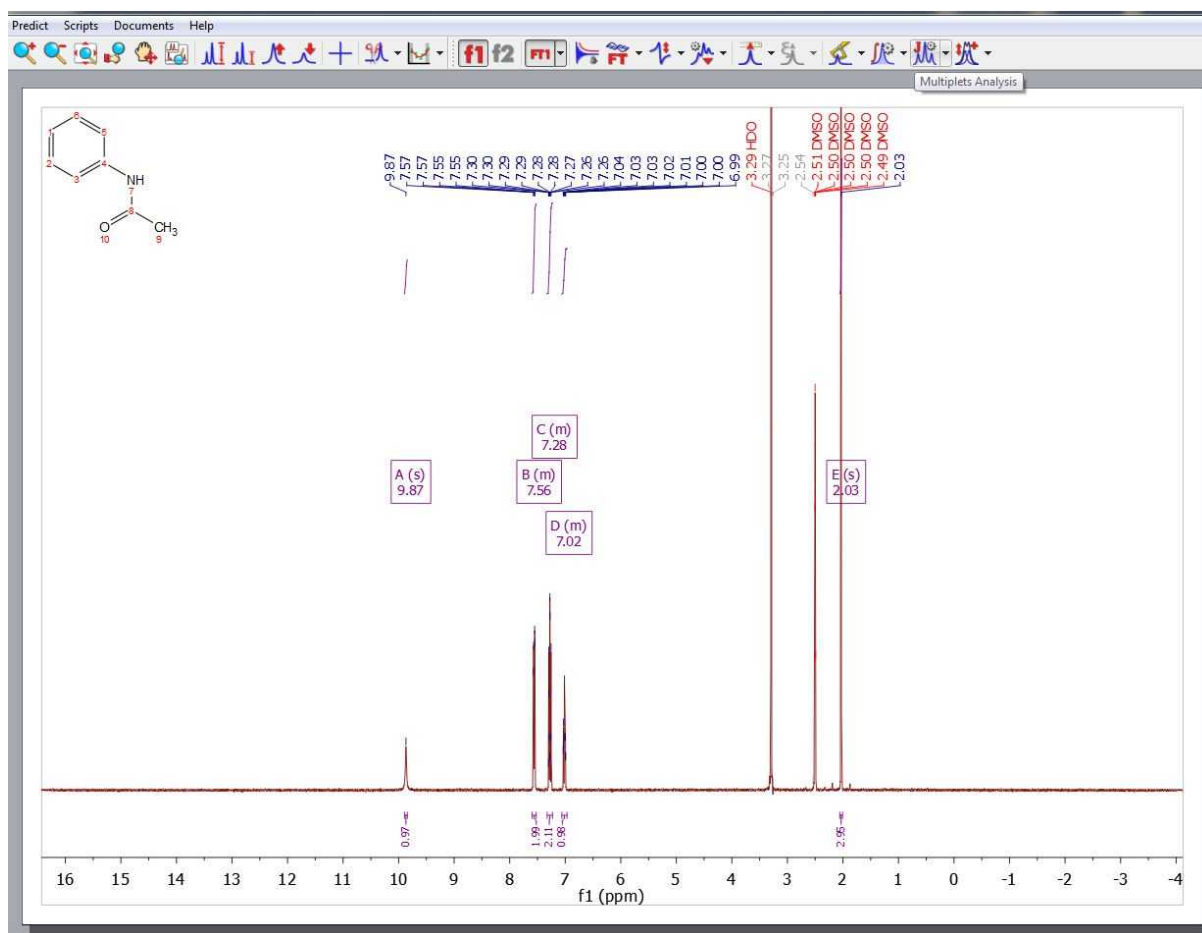

The qNMR functionality is selected from the “Advanced” menu item. The software stores all [settings](#) in the registry, so you may not have to change things. But you will need to provide some information the first time you use this. This will be described in more detail, below. For this tutorial, we have clicked on the ‘Settings’ button of the qNMR panel and then on the ‘Load Parameters’ button to load the ‘1_acetanilide.data’ file (which you have downloaded together with the dataset in the previous step):

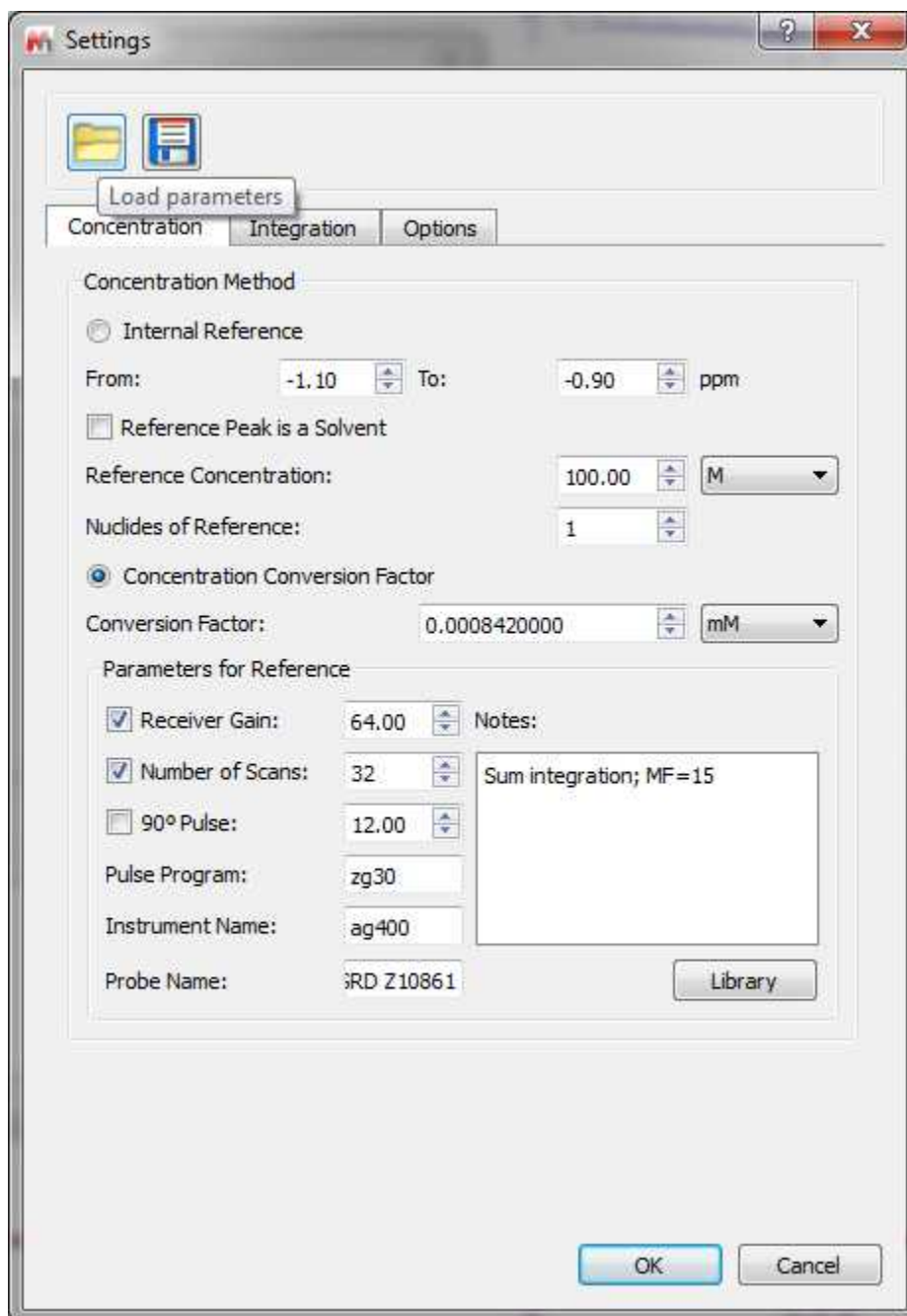

After having clicked on the OK button, the qNMR panel will be displayed with the information about the multiplets and absolute integrals found for their bounds. Having the correct number of nucleides is important and the software may do this better if the molecular structure is available and plotted.

qNMR

Report Report to File Settings Autoselection Refresh

Concentration Average: 20.2121 mM
 RMSD(%): 0.2430
 Area %qNMR: 99.3560

Line Fitting

	Multiplet	Autoselected	Shift	Range	Hs	Abs. Integral	Concentration
1	<input checked="" type="checkbox"/> C(m)	1	7.28	7.33..7.22	2	48133.4225	20.2642
2	<input checked="" type="checkbox"/> D(tt)	1	7.01	7.07..6.95	1	23926.4044	20.1460
3	<input checked="" type="checkbox"/> E(s)	1	2.03	2.06..2.00	3	71969.3298	20.1994
4	<input type="checkbox"/> A(s)	0	9.87	10.20..9.54	1	21609.2674	18.1950
5	<input type="checkbox"/> B(m)	0	7.56	7.64..7.50	2	47541.2932	20.0149

Warnings





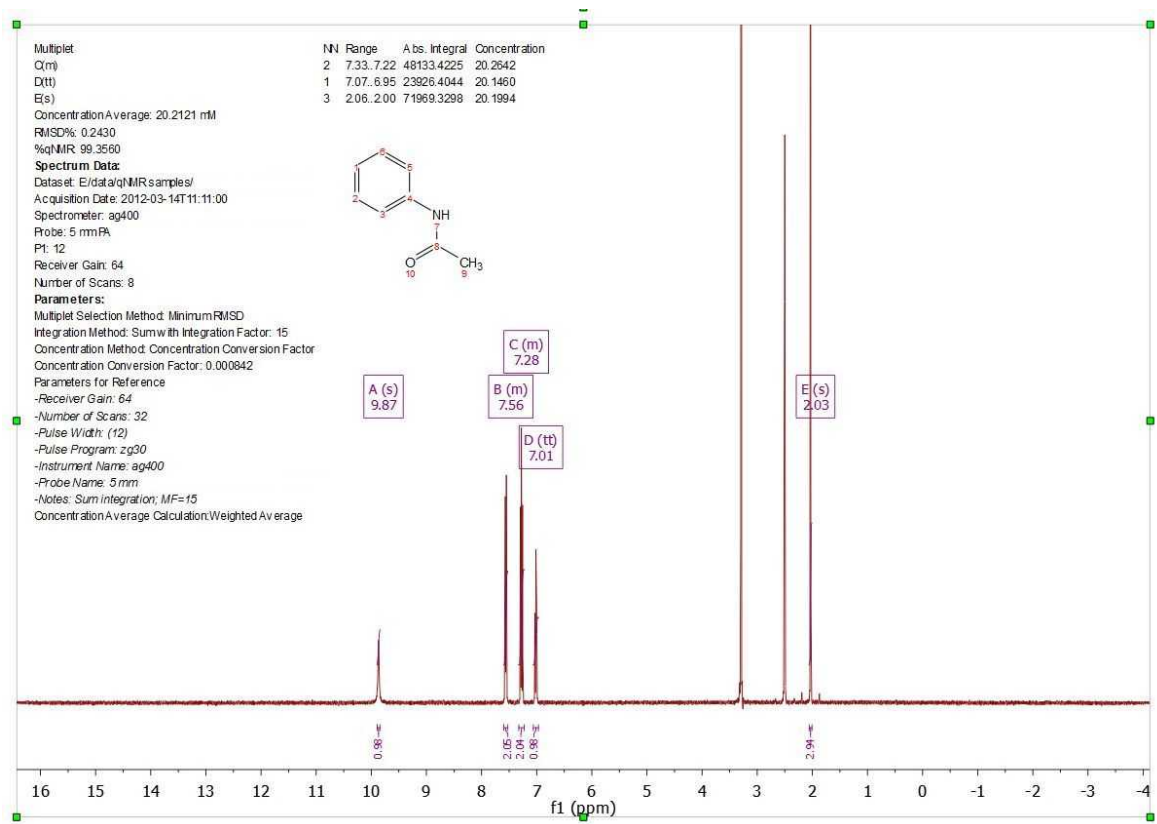

At this stage the qNMR process will be done automatically and the multiplets sorted in the table based on their perceived ranking as candidates for qNMR. The selected multiplets can be changed and the effect on the derived concentration. The concentration averaged calculated for this example is 20.2 mM.

You will find different button in the qNMR panel above:



1. Report qNMR results on the spectrum page:



2.  Report to File Export qNMR results to a txt file
3.  Settings Show the "Settings" dialogues
4.  Autoselection Selects best multiplets based on rules (see [qNMR Settings](#))
5.  Refresh Refresh the calculation. (Not needed if "Autorefresh" is deselected in Settings.)
6.  Select all/no multiplets. (An alternative to 4)
7.  Line Fitting Apply line fitting

The user can check the applicable boxes to manually select/deselect the multiplets that will be used to calculate the concentration information. The "Hs" for a multiplet can be manually changed by clicking on the number.

11.2 qNMR Settings

Selecting 'Settings' on the qNMR panel, will display the dialog box below, containing 3 different tabs (Concentration, Integration and Options):

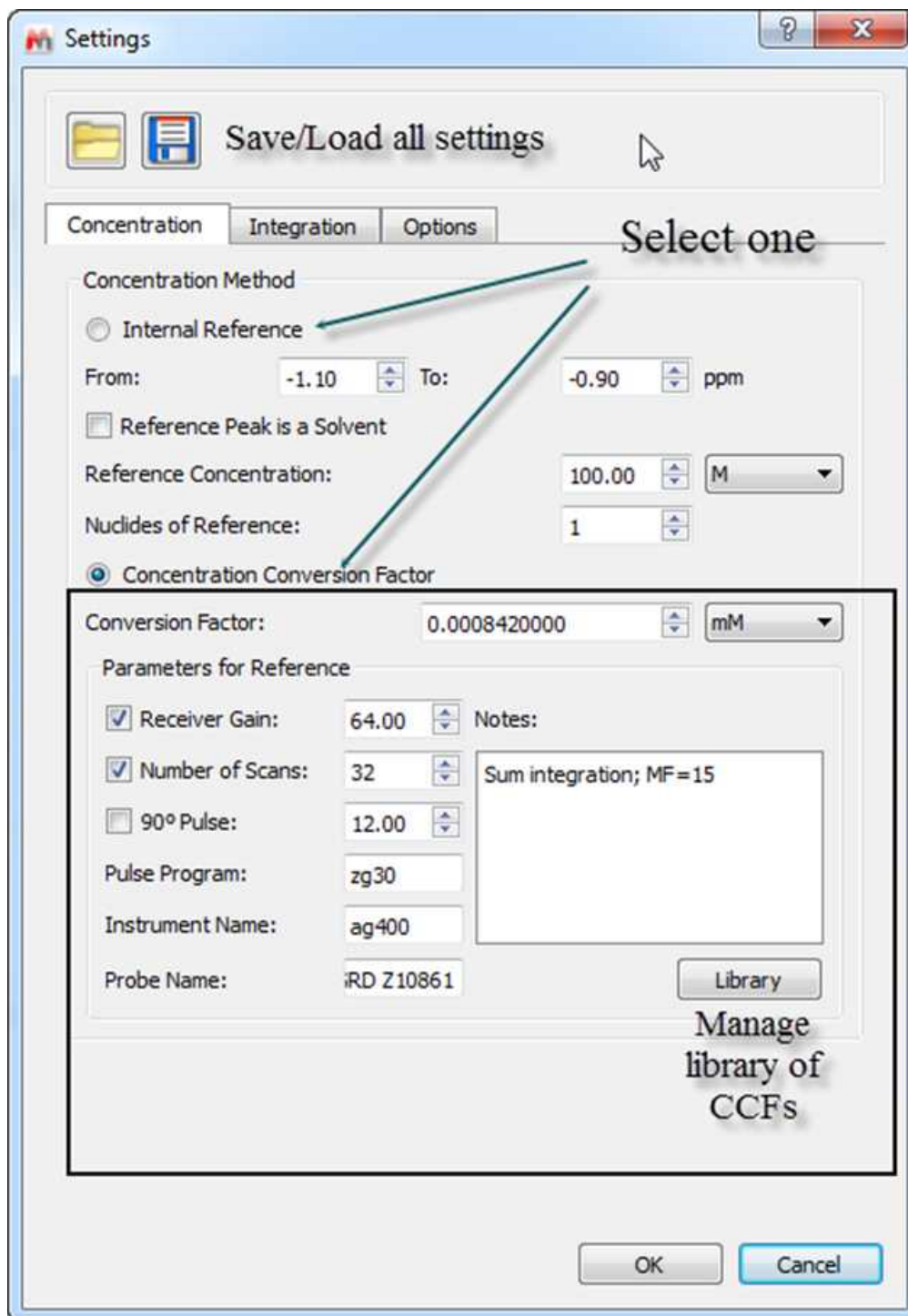

Note first the "Save" and "Load" buttons. These will allow you to set up the correct settings for

parameters and distribute amongst other users to ensure they do the analysis correctly

Concentration

Fundamentally, there are two ways to determine concentration: using a signal as an “internal reference”, or a specified “Concentration Conversion Factor” (CCF). The internal reference may be a real signal area (e.g., residual solvent, TMS) or an artificial signal (e.g. ERETIC or QUANTAS). If a residual solvent is used then the “Reference peak is a solvent” box should be checked, and then only peaks of type “Solvent” in the chemical shift range will be used for area calculation. This can be useful to exclude errors that would result if impurity, analyte or other peaks were used, and this is a nice feature that follows from AutoClassify.

Concentration Conversion Factor

Currently, we only support CCFs that have been determined using data processed within Mnova – there can be significant errors if Bruker 1r files are used. The CCF is determined for a particular experimental setup by processing the spectrum of a compound of known and specified concentration, and adjusting the “Conversion Factor” until the correct concentration is reported.

Library of CCFs

It is important to account for the fact that a CCF value will have a fundamental, strong dependence on the spectrometer hardware: the particular NMR spectrometer and probe, principally. This must be determined each time empirically, as described above. After that is done, simple mathematical compensations can be made for differences in the receiver gain, number of scans, or 90° pulse length. If necessary, a different value can also be determined and saved for different solvents.

To facilitate this, the user can save these to a file – and distribute this, of course.

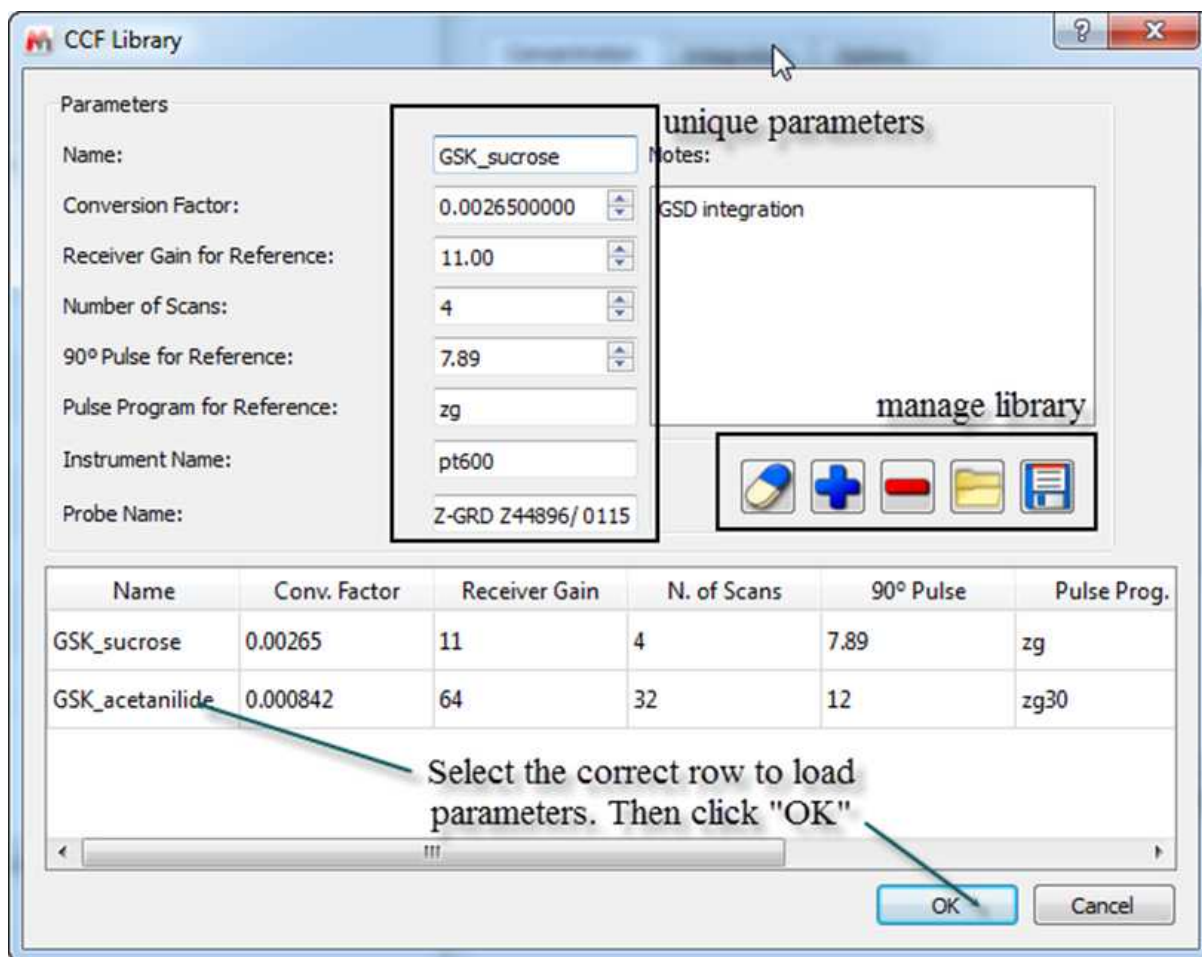

To add a new library condition the user will populate the parameter fields correctly, click the blue "+" button to add to the library, and save the updated data file.

To select a different CFF, highlight the row and click "OK". The software will check that the parameters match if specified, and this information will be included in all reporting.

Integration

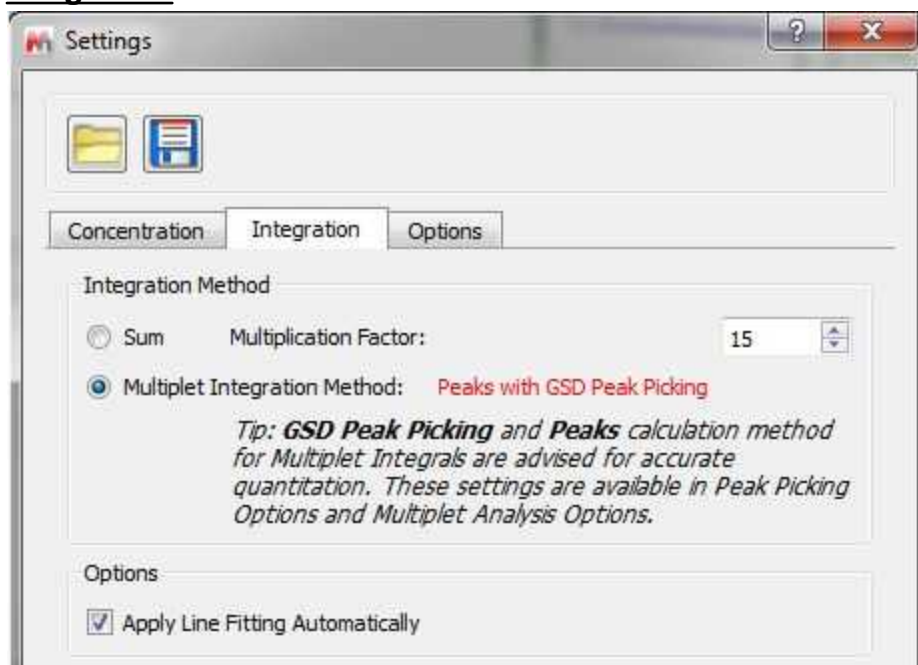

The user can select between these options:

1. Sum integration. This is the “traditional” integration method. The “Multiplication factor” should be set to a value of 15-20, and determines the integration limits with consideration of line-width. Sum integration is a poor choice with mediocre or poor S:N spectra, or if the spectrum is quite crowded – multiplets are close to one another. *If using this selection the spectrum must be very well phased and baseline corrected.*
2. GSD integration. As the tip says, this is set from the Peaks/Options, but GSD is the default. This should probably be the default selection for most cases.
3. Line fitting checkbox. There may be cases where GSD doesn’t do a fantastic job: look for this in the case of singlets. So line fitting may be necessary for QUANTAS/ERETIC internal references, as these signals are singlets. Checking this box has the same effect as pressing the “Line Fitting” button on the results page.

Options

This is where all other settings are grouped, including the very important multiplet selection criteria.

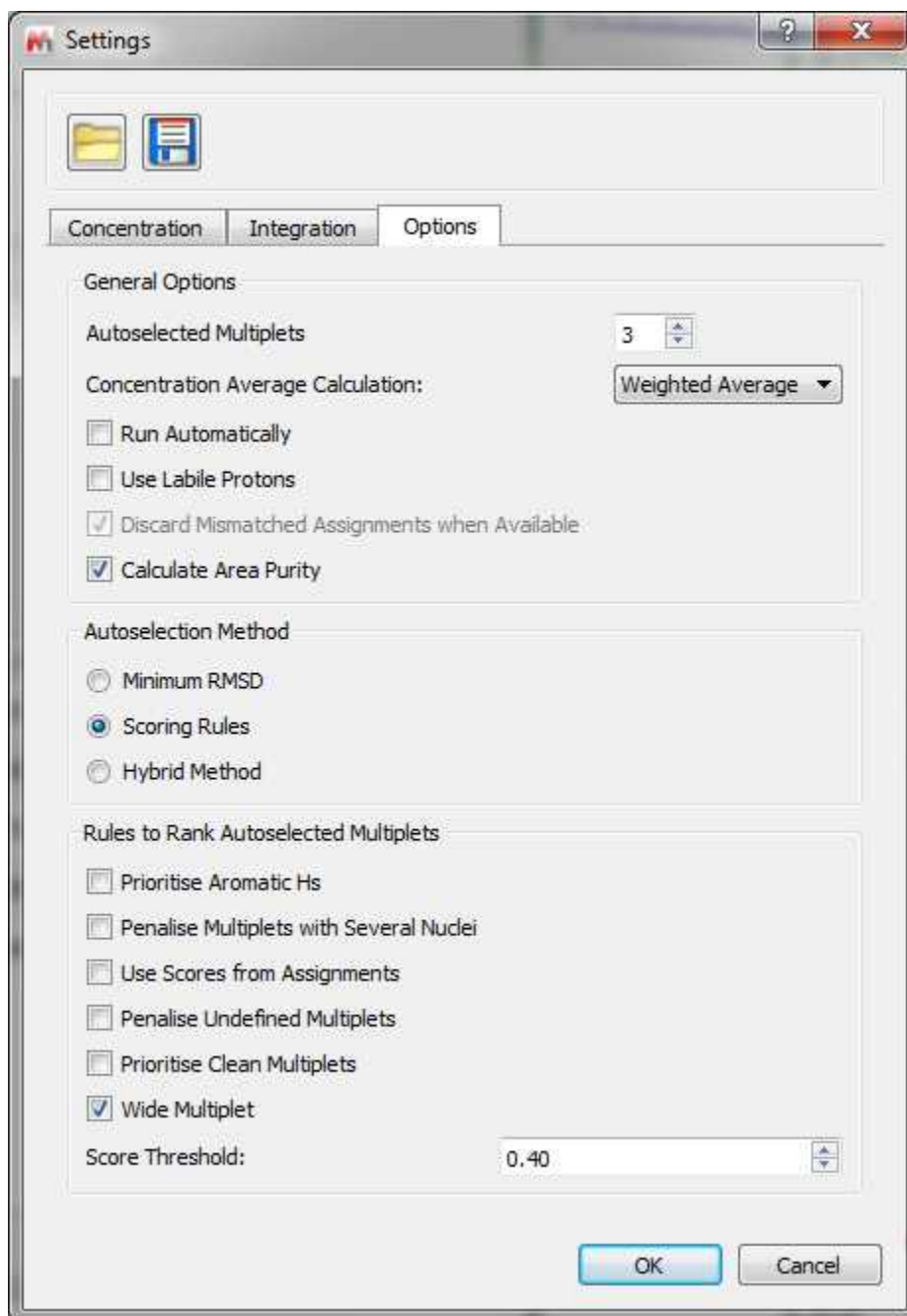

1. General Options.

- a. Autoselected multiplets. The target (max.) number of multiplets that will be used for the final concentration determination. The score threshold, labiles use, etc. will be respected.
- b. Concentration average calculation. Difference in how the average is calculated. Simple average will calculate the mean average of the concentrations. Weighted Average will calculate the concentration with the sum of the integrals, divided by the sum of the nuclei and multiplied by the scaling factor.
- c. Run automatically. If deselected the user must click the "Refresh" button to trigger the calculation.
- d. Use labile protons. The default is to ignore labile protons (if categorised), but if you check this box then the restriction is lifted. The thinking is that signals from labile protons almost

always under-integrate, and should not be included in qNMR calculations. This offers a partial workaround if the user really wants to use labiles. This rule is applied if "Use Labile Protons" is checked; multiplets considered to be or contain labile protons will be penalized by a factor of 0.25. If unchecked, labiles have a score of 0.0 and are therefore omitted.

- e. Discard mismatched assignments when available. This test uses nuclide information from AutoAssignment and checks that it matched with NN from the multiplets. If they are not in accord the multiplet will have its score lowered.
- f. Calculate area purity. If checked, this will show with the results summary. It is calculated using the sum of areas for compound and impurities (from GSD), and is something of a rough value:

$$\% \text{ Purity} = (A(C) / (A(C) + A(I))) * 100.0$$

A(C) is the sum of the GSD areas for peaks labelled as compound
 A(I) is the sum of the GSD areas for peaks labelled as impurity

2. Autoselection Method

These methods will all try to select the number of multiplets in 1a, whilst respecting the score threshold (3g).

- a. Minimum RMSD. This option will ignore the multiplet scores and simply choose the multiplets that give the smallest RMSD in the average concentration. It may be used for very pure compound spectra. The maximum number to be used is the user-selectable "Autoselected Multiplets".
- b. Scoring rules. This applies the rules selected in section 3, below, and then uses the top multiplets to determine the average concentration (and RMSD). The maximum number to be used is the user-selectable "Autoselected Multiplets".
- c. Hybrid method. This method first applies the scoring rules and then chooses amongst the highest scoring multiplets. Using the multiplets whose final score exceeds the score threshold, the multiplets that give the smallest RMSD are identified and used for the final average concentration calculation (and RMSD).

3. Rules to rank autoselected multiplets

- a. Prioritise aromatic Hs. Non-aromatic multiplets will have their scores penalised. Especially useful when the aliphatic region is complicated by large residual/impurity peaks or when solvent saturation is used. If the user checks the option, the aromatic Factor will be 1 for an Aromatic multiplet, and a non-Aromatic H is multiplied by 0.5 (Aromatic range=5.5-12ppm).
- b. Penalise multiplets with several nuclei. Prioritises multiplets having the fewest NN. This assumes that impurities can lead to a false NN. The score is multiplied by 1/NN: the larger NN, the lower the score.
- c. Use scores from assignments. If Verify/AutoAssign was used, the individual multiplet scores will be taken into account. A multiplet with a higher assignment score Q(-1 to 1) will be scored higher. $Assignments \text{ Factor} = 0.75 + Q/4$
- d. Penalise undefined multiplets. The thought is that a multiplet marked as "m" may be a clear solute multiplet but complicated by impurity peaks. In this case the "m" is penalised. The factor will be 0.6 for 'm' or 's' multiplet types, and 1 for all others.
- e. Prioritise clean multiplets. The presence of impurity peaks will cause a 10X increase in their relevance when determining the score. Use when spectra are very clean.

$$\text{Clean Multiplets factor} = \text{multipletPeaksSum} / (\text{multipletPeaksSum} + \text{noMultipletPeaksSum})$$

multipletPeaksSum is the total sum of the areas of all the peaks

noMultipletPeaksSum is the sum of the areas of the peaks not assigned to the multiplet

There is a further correction for peaks labeled as impurities: the area for this peak type will be increased x10.

- f. Wide multiplet. Penalises a multiplet having a width >60 Hz. This case can arise when the multiplet picks up impurity peaks. Consider using with dirtier spectra. The score is divided by 2 if the width of the multiplet is greater than 60Hz.

- g. Score threshold. Multiplets having a score below this number will not be used in the average concentration determination. A value of 0.3 is typical. (Scores are between 1 and 0.).

11.3 Batch qNMR

Having the applicable license, it would possible to run qNMR analysis in batch mode by using the Mnova scripting engine:

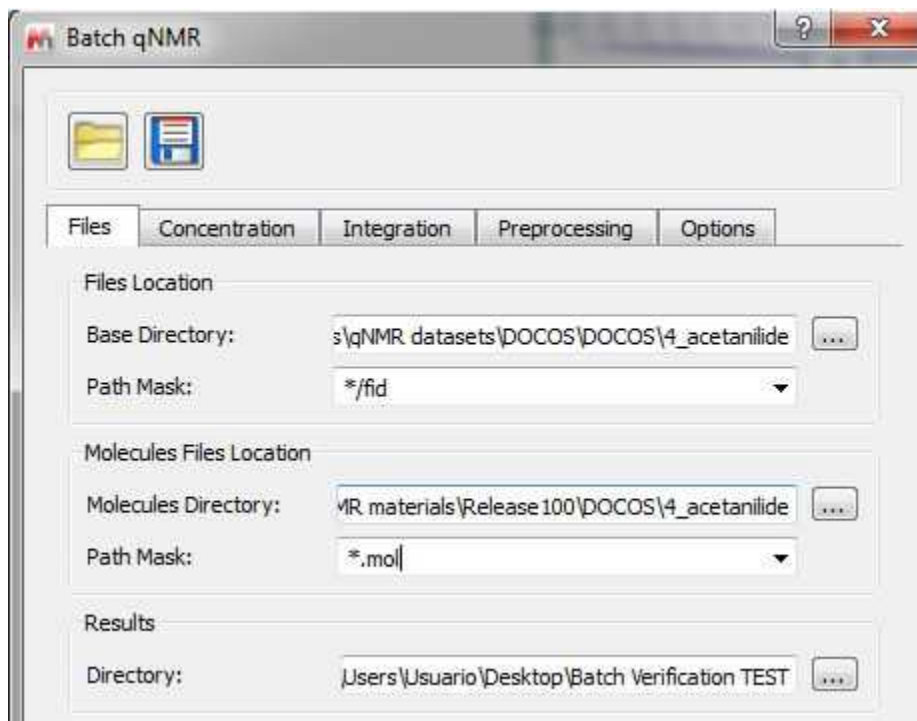

From the 'Files' tab, you will be able to select the file locations and also the folder where you want to save your results.

You will find several tabs for your 'Concentration', 'Integration', 'Reprocessing' and 'Options' settings (as you have in the [qNMR single mode](#)):

Batch qNMR

Files Concentration Integration Preprocessing Options

Concentration Method

Internal Reference

From: -1.10 To: -0.90 ppm

Reference Peak is a Solvent

Reference Concentration: 100.00 M

Nuclides of Reference: 1

Concentration Conversion Factor:

Conversion Factor: 0.0008420000 mM

Parameters for Reference

Receiver Gain: 64.00

Number of Scans: 32

90° Pulse: 12.00

Pulse Program: zg30

Instrument Name: ag400

Probe Name: 5 mm PABBO BB-1H/ D Z-GRD Z10861

Notes: Sum integration; MF=15

Library

Load Concentration Data

Files Directory: C:\Users\Usuario\Desktop\qNMR materials\qNMR datasets\DOCOS\DOCOS

Path Mask:

OK Cancel

The integration tab will allow you to select the integration algorithm and also some peaks classifications:

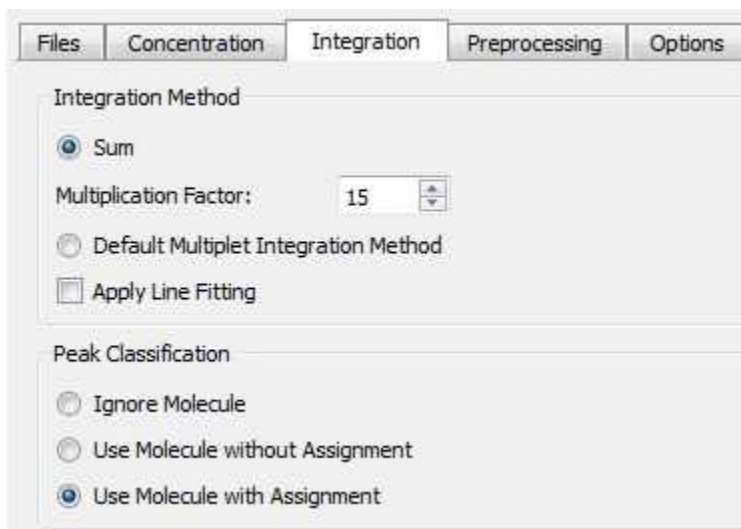

It will be also possible to use 'preprocessing templates':

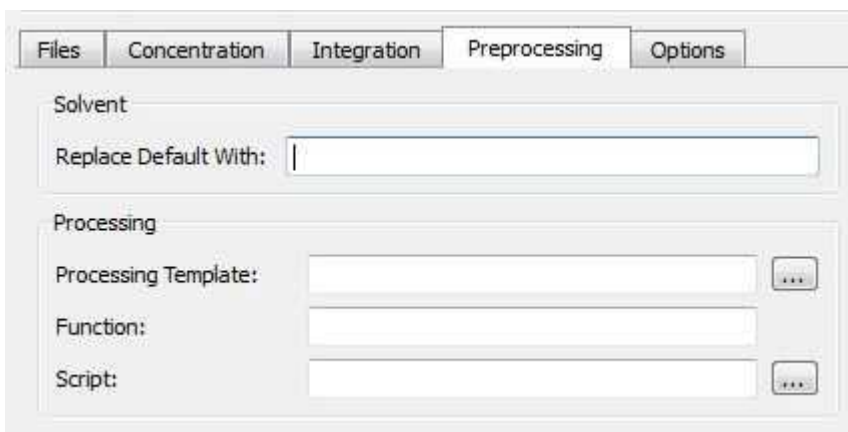

Solvent/Replace Default With: This allows users to handle situations in which the solvent may be wrong in the parameters. It can be the case that a certain batch has been run on a specific solvent but that the user left the default solvent on the spectrometer data entry and therefore the solvent could be wrongly entered. Since the target solvents will affect the performance of the Autoedit function in Mnova qNMR, it is important to be able to correct for this at the script level. Use 'none' if solvent saturation was used, and a blind region excludes it. This prevents GSD from getting confused.

From this menu, you can also apply a processing template or a script or a function the user would like to run prior to each qNMR analysis being performed.

The options tabbed menu will be similar with the one in the qNMR single mode [settings](#):



After the analysis has run the qNMR Viewer can be used. You must navigate to the “results” directory and look for a directory there, and load the “results.dat” file to see something like this:

qNMR Viewer

Load Save Clear Create Report Paste Table

	Concentration	RMDS	qNMR%	Spectra
1	20.1604	0.3525	99.3277	AG3682.13.fid
2	20.0848	0.4517	99.3154	AG3682.15.fid
3	20.3183	0.9998	97.2312	AG3682.11.fid
4	20.1903	0.4424	99.3134	AG3682.14.fid
5	20.4011	0.3092	98.8004	AG3682.12.fid
6	20.1073	0.2894	99.3942	AG3682.16.fid
7	19.9977	0.5416	98.8922	AG3682.17.fid
8	19.9163	0.4095	98.9923	AG3682.18.fid

	Multiplet	NN	Range	Significance	Concentration
1	B(m)	2	7.60..7.52	47665.4736	20.0672
2	D(m)	1	7.06..6.97	23903.8798	20.1271
3	E(s)	3	2.06..2.01	72091.1311	20.2336

It will be also possible to automatically run Batch qNMR as a listener. Mnova can 'listen' on a series of folders or drives and can grab data as is acquired and run the qNMR analysis automatically, saving the result in the selected folder. The settings for the qNMR listener can be selected under the 'Advanced/qNMR/Listener' menu.

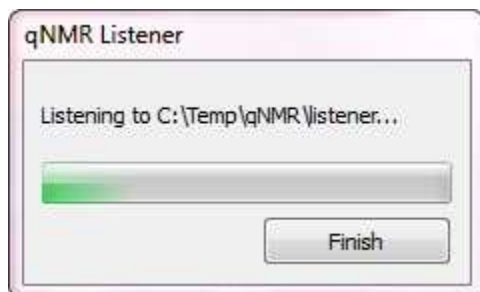

11.4 Purity Calculator

This new script can be run without a license of the qNMR plugin. You will only need a license of the NMR module. This script is located under the 'Scripts/NMR Tools' menu:

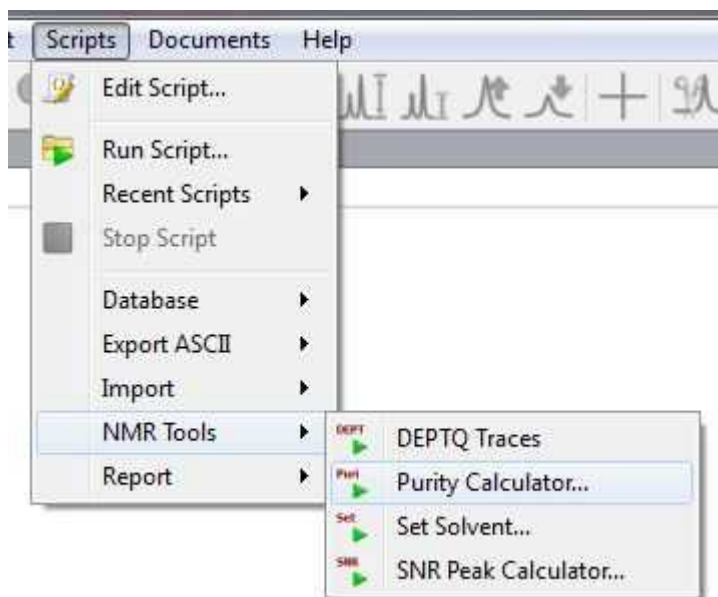

This method is still heavily used in some Development labs as a final check of compound purity. The spectra used must be of high quality with good shimming, acquired with sufficient time between pulses for full relaxation (typically 20-40 s in DMSO-d6). For processing the spectrum should be well very well phased (manually), and baseline corrected.

The example shown here is typical and doesn't present problems. Practical problems that may arise could be a large broad OH signal (which can sometimes be sharpened by adding a little TFA), or careful baseline correction. Other examples also require that you determine the salt ratio – but we don't deal with that here.

Just load the spectrum (which you can download from [here](#)) and follow the menu 'Scripts/NMR Tools/Purity Calculator' in order to fill in the sample details and choose the reference compound with the applicable molecular mass of the internal reference and its purity (you can load the reference compound details by loading the csv file that you downloaded in the previous step):

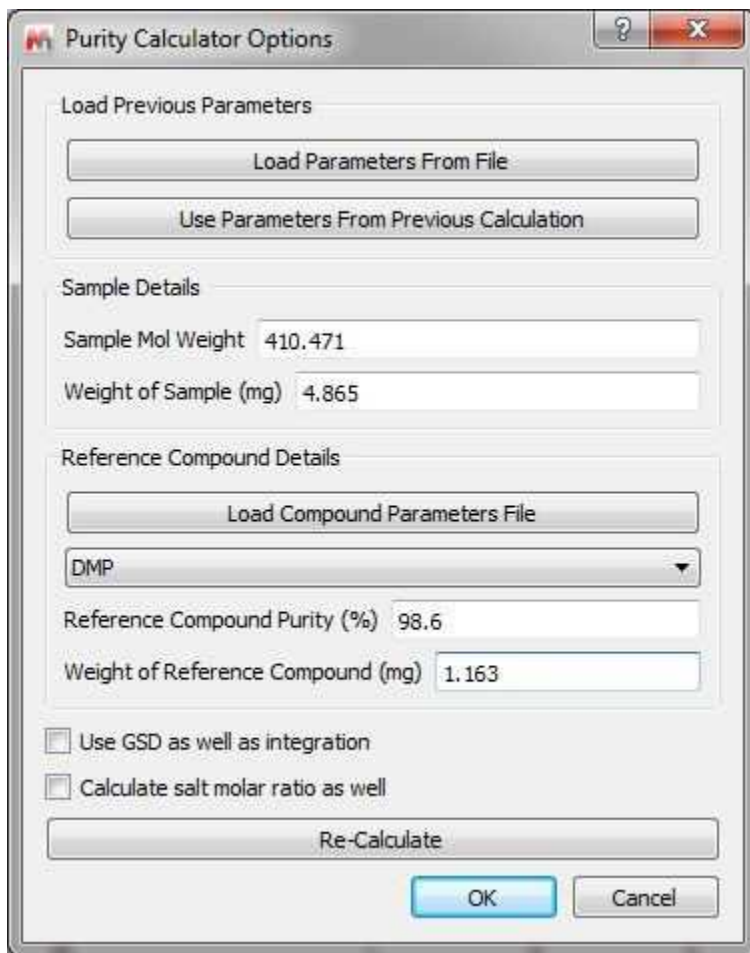

Clicking on OK, you will be prompted to integrate the signal that will be used as reference compound.

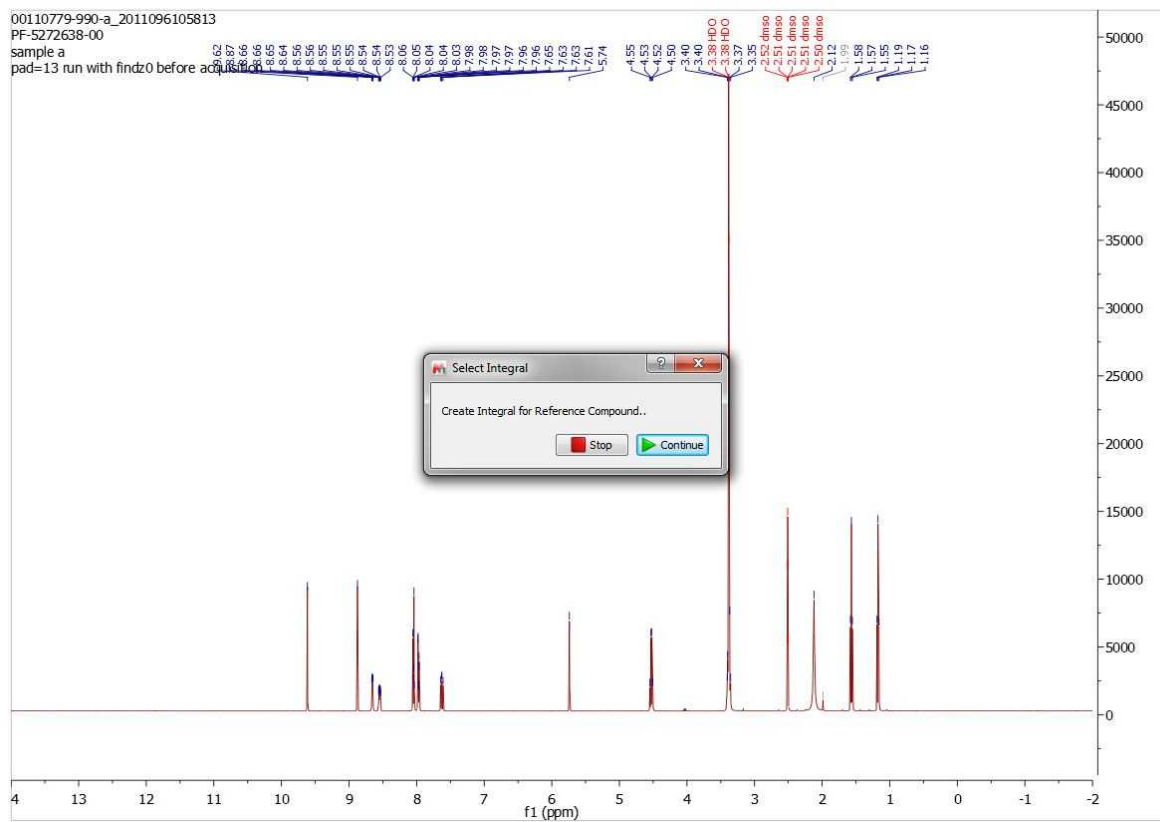

In that case, we will manually integrate the signal at 5.74ppm and click on the 'Continue' button:

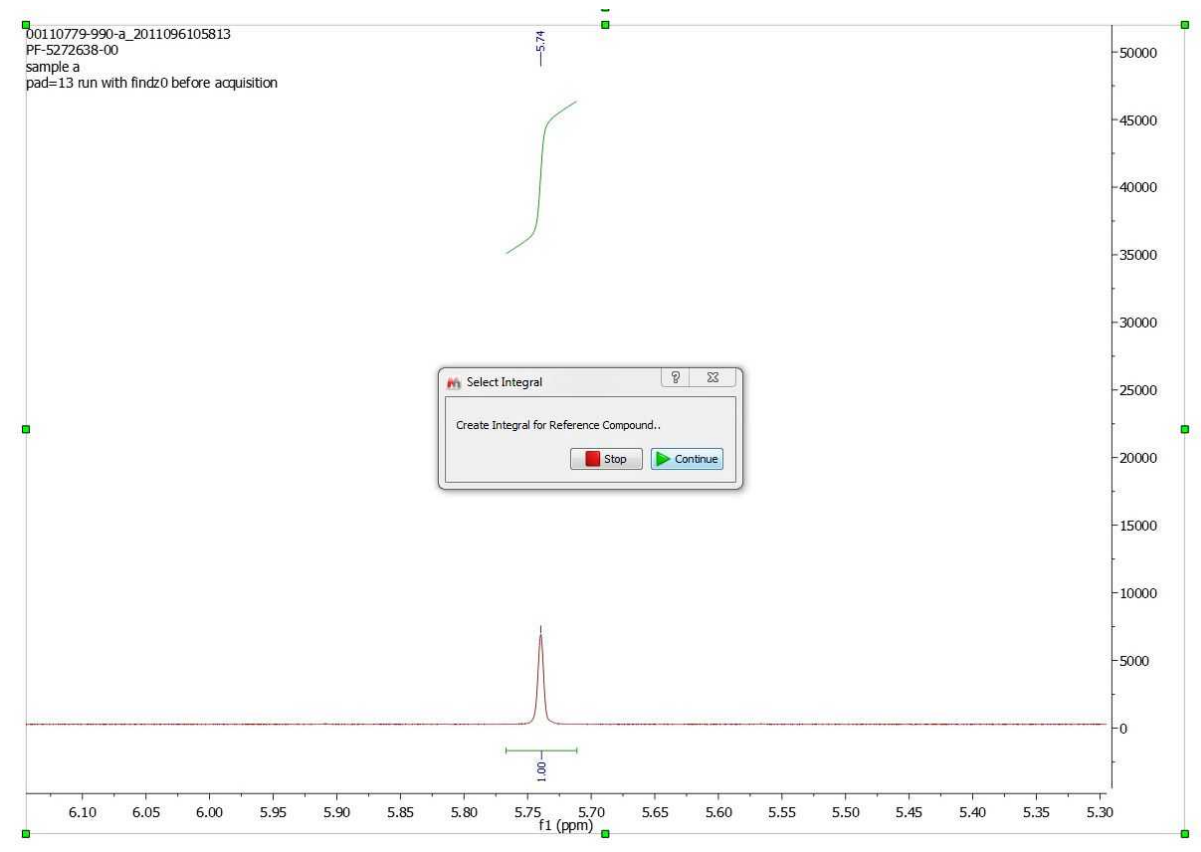

Now, we will integrate 3 multiplets for the analyte (choosing the aromatics close by). Once these have been integrated, click “Continue” again.

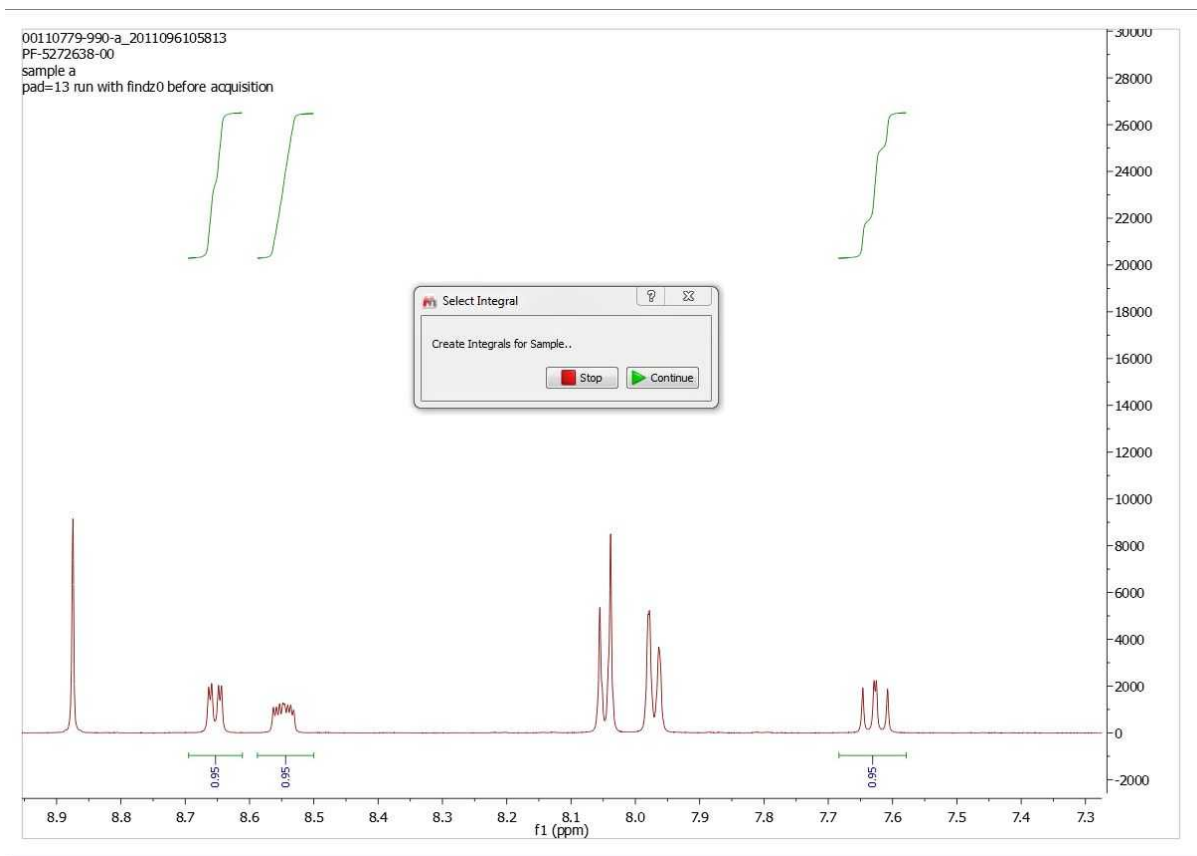

Clicking on the 'Continue' button will display the dialog box below:

Purity Calculator Options

Sample Details

Sample Mol Weight 410.471

Weight of Sample (mg) 4.865

Reference Compound Details

Load Compound Parameters File

DMP

Reference Compound Purity (%) 98.6

Weight of Reference Compound (mg) 1.163

Reference Compound Integral

Integral 5.49 - 5.95 ppm, value = 1

Nuclide Count 1

Sample Integrals

Purity = 95.82%

Integral 7.58 - 7.68 ppm, value = 0.95

Nuclide Count 1

Purity = 95.84%

Integral 8.61 - 8.69 ppm, value = 0.95

Nuclide Count 1

Purity = 95.34%

Integral 8.5 - 8.59 ppm, value = 0.95

Nuclide Count 1

Re-Calculate

Save Parameters

Add report on new page

OK Cancel

From that dialog box, if it is necessary, you will be able to adjust masses, see the purity result for each multiplet (they should be similar), see the number of nuclides values and you will be able to change the analyte peaks to be included in the calculation. Once all is OK, click on OK and the report will be added to the spectrum page (if the applicable box was checked) :

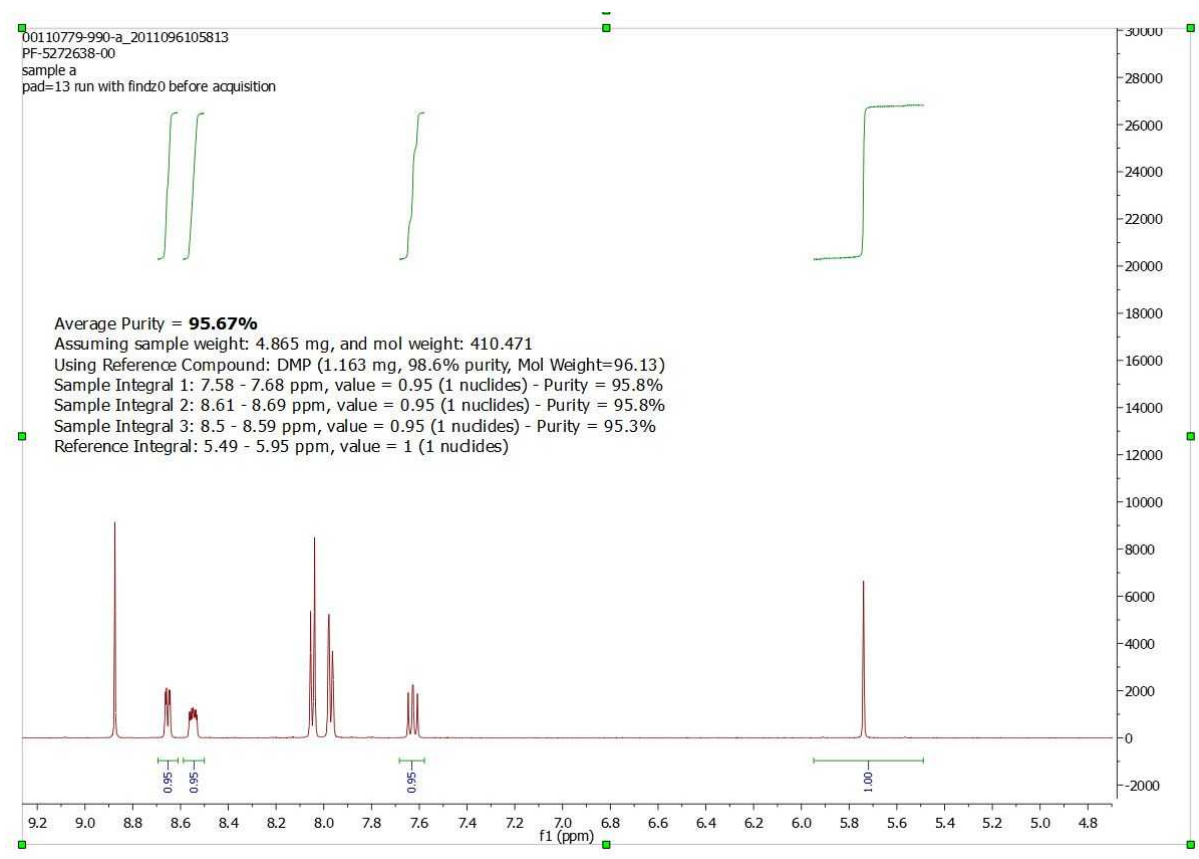

After that, if you plan to work with a similar dataset, you can load the spectrum and re-run the 'Purity Calculator' script, selecting "Use parameters from previous calculation". The only values you would need to change will be the masses.

for further information, please visit our blog:

<http://mestrelab.com/blog/article/purity-calculation/>

Part



12 Scripting with Mnova

Benefits and uses

The availability of scripting in Mnova provides opportunities and benefits both for skilled NMR and casual, non-expert users:

- Users are less dependent on the application developers for new features since scripting allows them to implement minor features themselves which can be deployed to less expert users.
- NMR administrators can write scripts to customize applications before deploying them to a group of users. For example, an NMR manager could create a script to automate some particular processing which he can distribute among his users in such a way that they will simply have to click one button (e.g. toolbar button) to apply that processing.
- Mnova developers can use scripting to prototype new features that can later be incorporated into the next version of the application. This is ideal when a client requires some processing/analysis feature not available in the application and cannot wait until a new version of Mnova is released.
- Mnova scripting language is based on an ECMAScript-based language making it easier for existing Web developers to customize and extend Mnova.

In essence, nearly everything that can be done with the Mnova graphical interface (UI) can be reproduced with Mnova's scripting module, making it very easy to automate repetitive tasks. For example, you may have to routinely process 1H NMR spectra using the same processing operations. You can create a script which wraps up all these processing functions in such a way that by simply clicking a toolbar button or pressing a keyboard shortcut, all of your 1H NMR spectra will be processed accordingly.

Furthermore, if some particular processing function is not available in Mnova, you can create a script which modifies the spectral data points according to your requirements.

Please do not forget to visit our script repository at: <http://mestrelab.com/scripts.html>

Introducing Mnova Script – Hello World

A "hello world" program has become the traditional first program that many books use to introduce a programming language. It will act as a cheatsheet for you until you familiarize yourself with the language. The point of this application is to use all the most commonly used elements of Mnova Script language and putting it in a single place so that you can refer to it later. We will start showing the basic elements of an Mnova script and from that point some more advanced methods will progressively be added.

Mnova scripts can be created with any text editor, although Mnova includes a specialized script editor with syntax highlighting and debugging output capabilities. This text editor is available from the Scripts/Edit Script menu command. Issue this command and type in the following text:

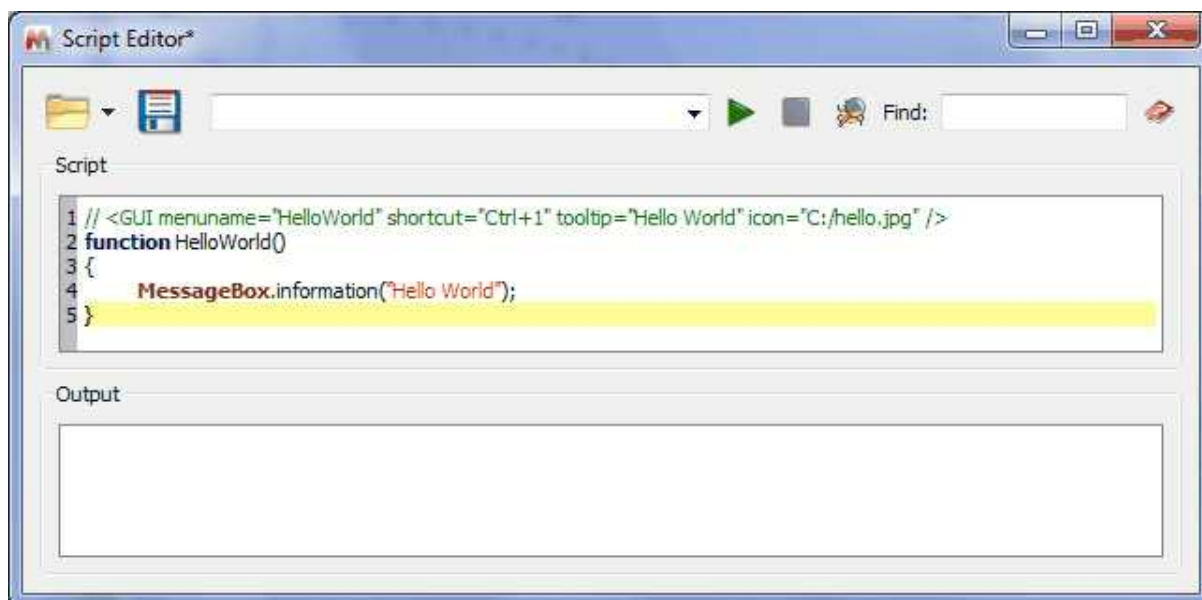

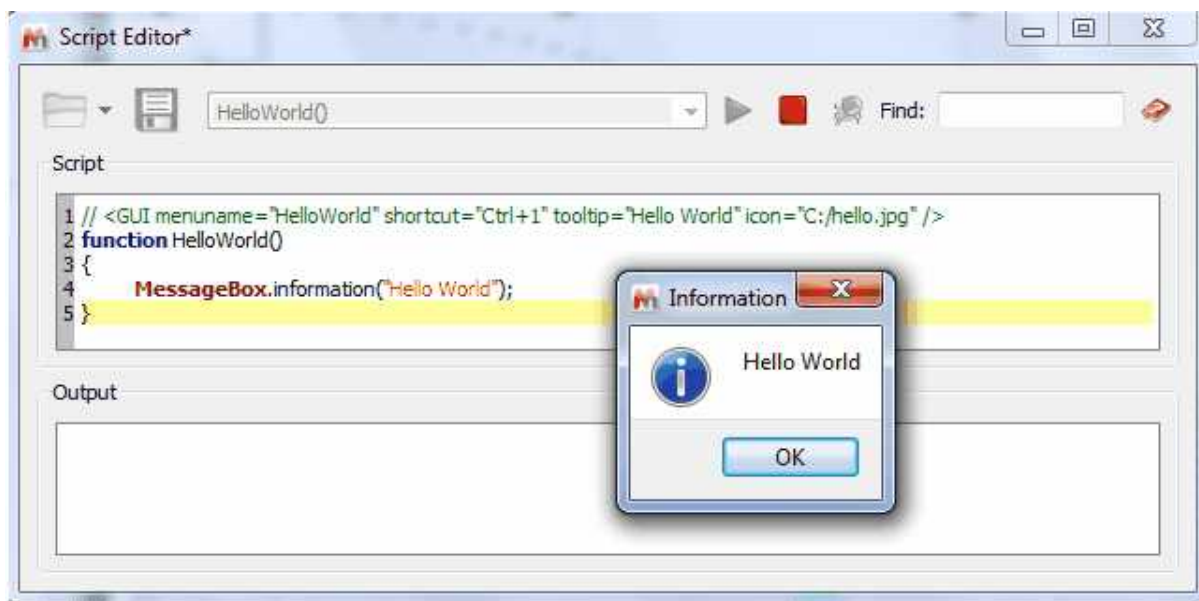

In this example we have defined a function called **helloWorld()** which will simply display a message box with the text 'Hello World'. Note that **MessageBox** is in bold, meaning that Mnova script editor recognizes it as a valid function.

Next, go to the edit control at the top of the script editor and type **helloWorld()**. Do not forget the brackets as they are required by the scripting framework in order to properly interpret the function. Once you have typed it, click on the green arrow at the right side of the edit control. You should get the pop up message box.

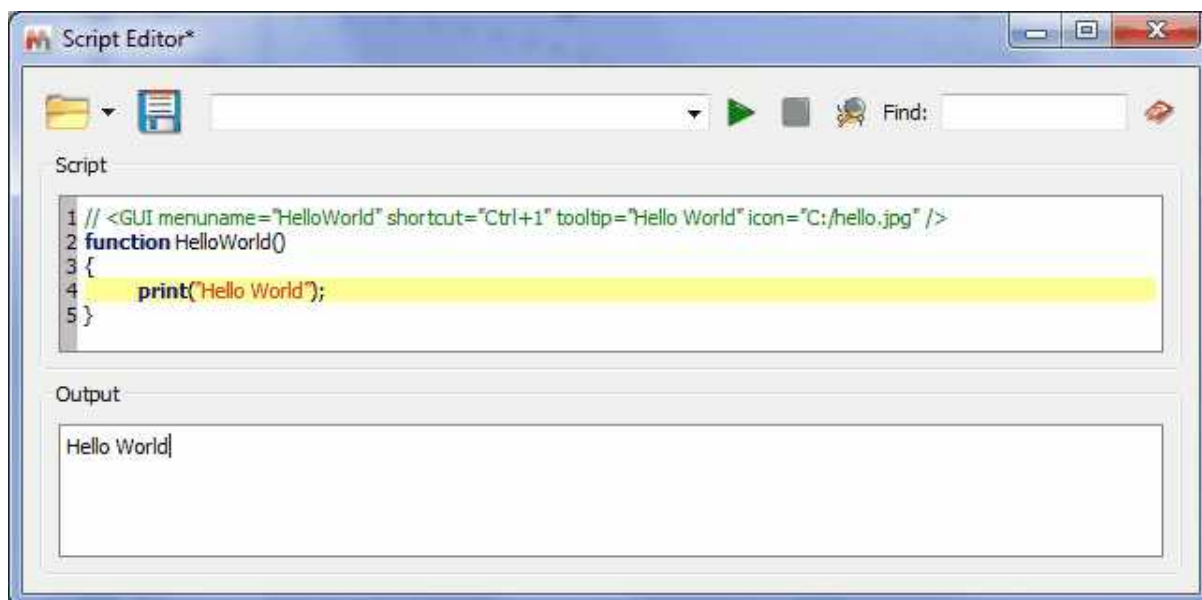

It is also possible to write information directly on the **output** control in the script dialog by using the **print** command as showed below. This is very useful when debugging scripts.



Please note that you will be able to load/save any script by using the applicable buttons . The play button will be used to run a script by typing the function on the edit box, whilst the stop button will stop a script in action. Clicking on the 'Help' button or pressing F1 will show you the 'Scripting help' window:

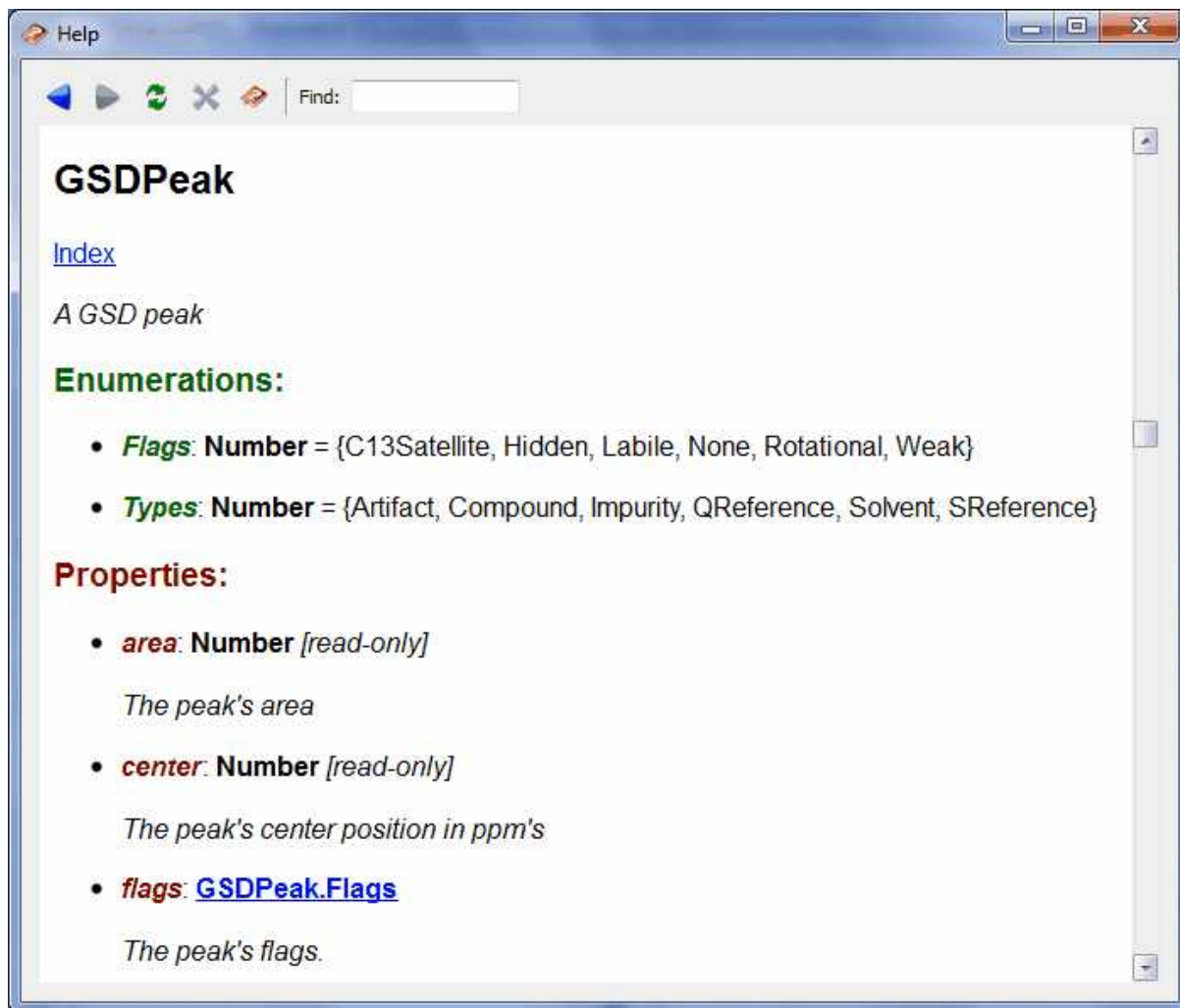

As Mnova scripting is an ECMAScript-based language, you can use any of the many functions and statements supported by this standard such as loops, conditions, etc. Remember that JavaScript is ECMAScript based too so if you are familiar with it or with C/C++, writing Mnova scripts should be very easy for you. If you are not familiar with the ECMAScript language (<http://doc.trolltech.com/4.3/ecmascript.html>), there are several existing tutorials and books that cover this subject, such as [JavaScript: The Definitive Guide](#).

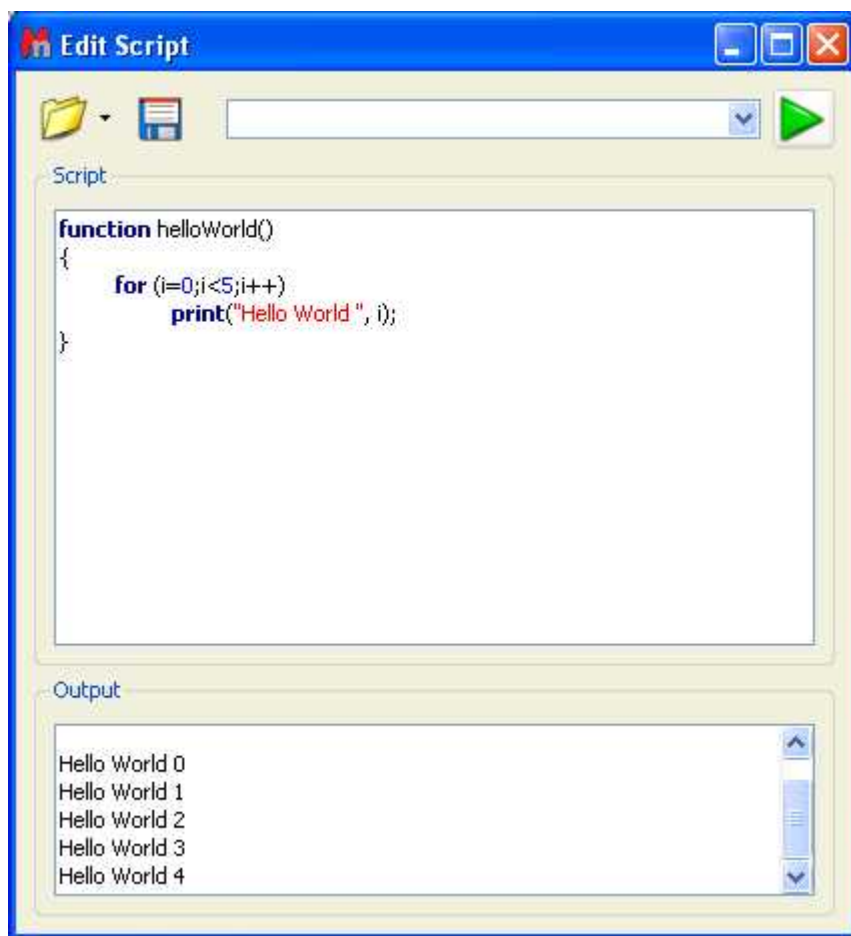

Where should the scripts be saved?

In principle you could save your scripts anywhere in your computer. However, it's strongly recommended to save them in a custom **scripts** folder, that you can create from the "Edit/Preferences/Scripts/Directories" menu:

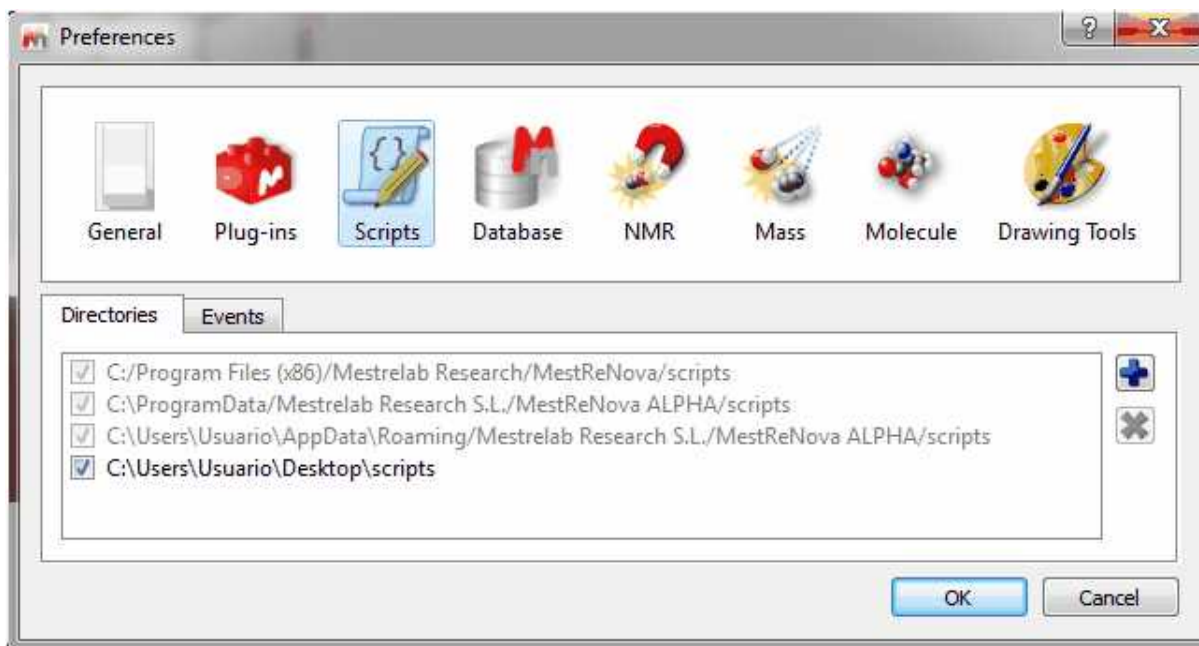

This is very important to allow Mnova to find these scripts when starting in such a way that they can be added to the GUI of Mnova (e.g. Toolbars, Menus, etc).

For example, type the following script:

```
//      <GUI      menuname="HelloWorld"      shortcut="Ctrl+1"
tooltip="Hello World" icon="C:/bin2.jpg" />
function HelloWorld()
{
    MessageBox.information("Hello World");
}
```

And save it in the scripts directory (program data ...) . Now close Mnova and open it again.

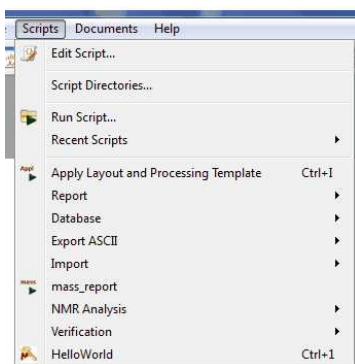

You will appreciate that the script is available in the menu bar. The key to get this working lies in the first line of the script (and of course, in the fact that Mnova can locate the script as it has been saved in the appropriate folder):

```
//      <GUI      menuname="HelloWorld"      shortcut="Ctrl+1"
tooltip="Hello World" icon="C:/bin2.jpg" />
```

This line is used to instruct Mnova about the name to be displayed in the scripts menu along with the keyboard shortcut and the text used as a tooltip. For a full description on the usage of this line, see [connecting scripts](#) and [Mnova GUI](#) section below.

It is also possible to create dialog boxes with controls. The script below shows a simple example.

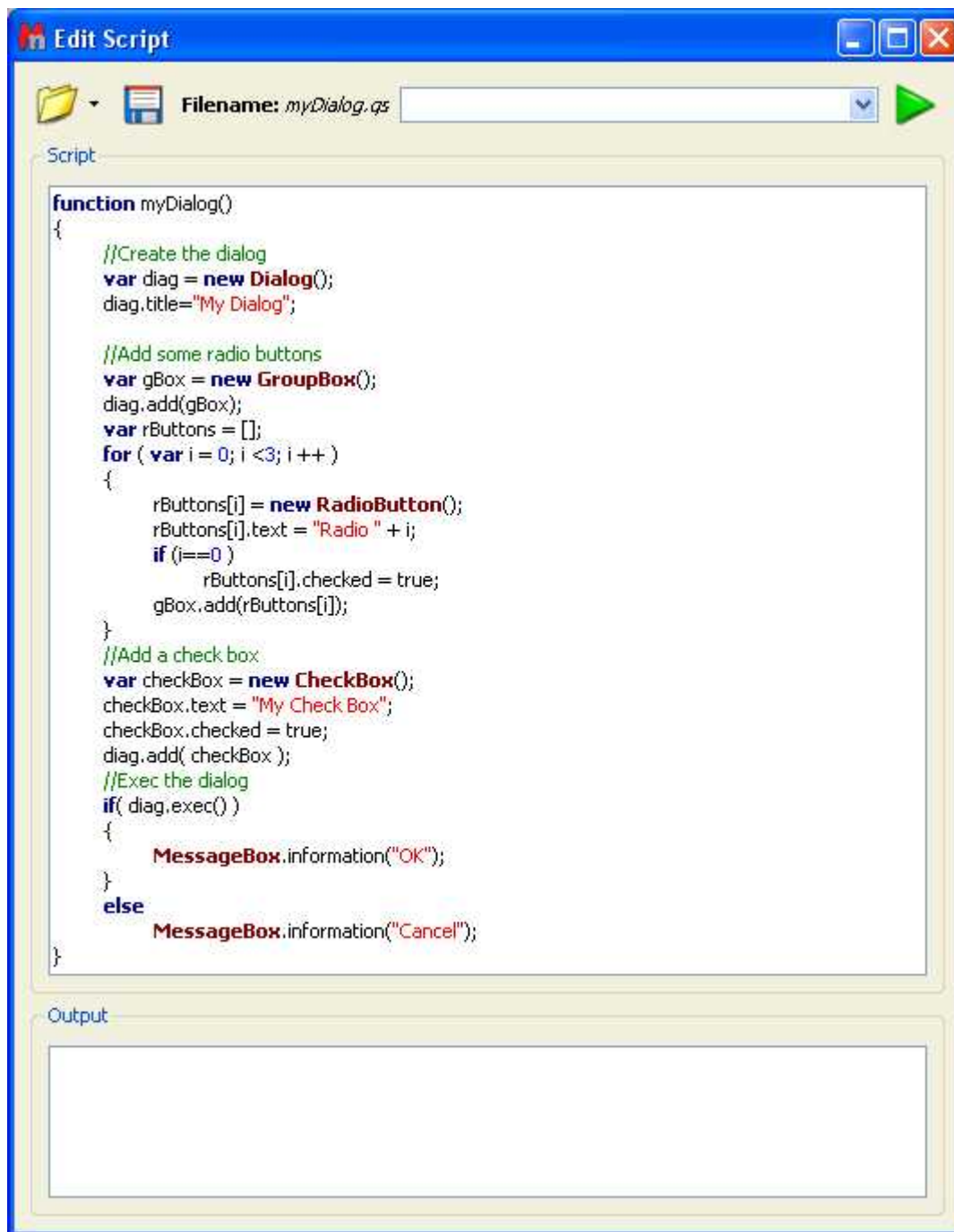

```
function myDialog()
{
    //Create the dialog
    var diag = new Dialog();
    diag.title="My Dialog";

    //Add some radio buttons
    var groupBox = new GroupBox();
    diag.add(groupBox);
    var rButtons = [];
    for ( var i = 0; i <3; i ++ )
    {
        rButtons[i] = new RadioButton();
        rButtons[i].text = "Radio " + i;
        if (i==0)
            rButtons[i].checked = true;
        groupBox.add(rButtons[i]);
    }
    //Add a check box
    var checkBox = new CheckBox();
    checkBox.text = "My Check Box";
    checkBox.checked = true;
    diag.add( checkBox );
    //Exec the dialog
    if( diag.exec() )
    {
        MessageBox.information("OK");
    }
    else
        MessageBox.information("Cancel");
}
```

Execution of this script results in the following dialog box:



Scripting Events

Following the menu "Edit/Preferences/Scripts/Directories", you will find an 'Events' label; which will allow you to add any event (which will run by default in Mnova). You will find an example script about it (eventHandlerExample.qs) in the MestReNova examples script installation folder.

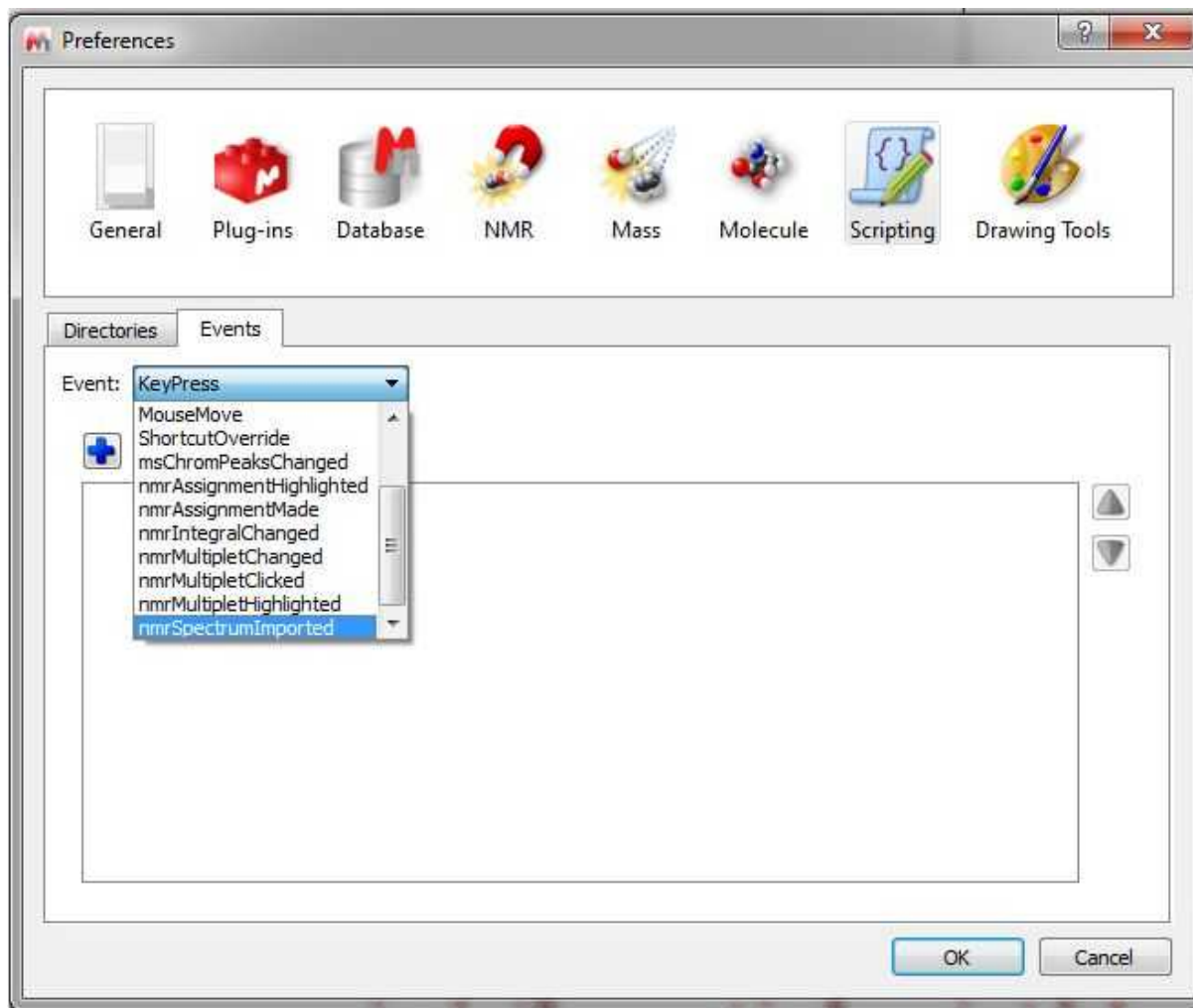

For example, imagine that you always want to open your 1D datasets with a specific zoom area. You can create an event to do it. To do it, just save this script in your Scripts directories:

```

function spectrumZoom(aJSONString)
{
    var info = JSON.parse(aJSONString)
    var actDoc = mainWindow.activeDocument
    var spc = new
NMRspectrum(actDoc.getItem(info.itemId));
    if( !spc.isValid() )
        return false;
    spc.horzZoom(1.0, 5.0);
    spc.vertZoom(-100.0,8000.0);
    /*if( spc.dimCount == 1 )
        spc.zoom(3.0, 4.5);
    else
        spc.zoom(1.0, 5.0, 1.0, 5.0);*/
    //spc.zoom();
    spc.update();
    mainWindow.activeWindow().update();
    return true
}
Application.mainWindow.installEventHandler("nmrSpectrumImported", "spectrumZoom")

```

Then restart Mnova and select it (spectrum zoom) as an event in the 'Edit/Preferences/Scripts/Events/nmrSpectrumImported' menu. this will open your 1D-NMR spectra with a spectral window from 1 to 5 ppm

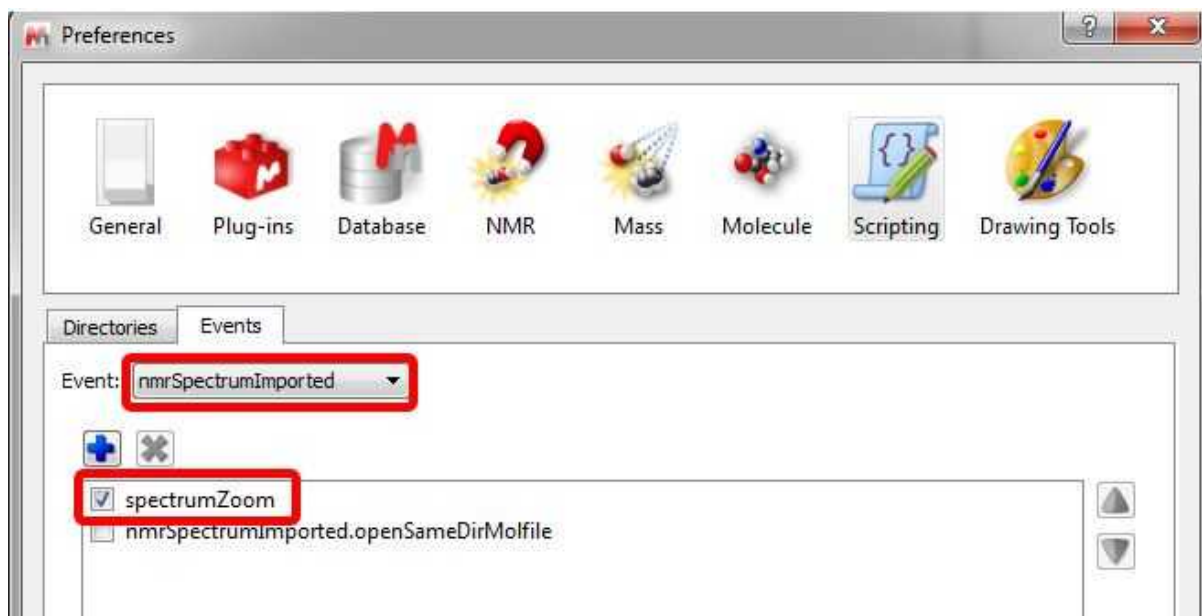

12.1 Connecting scripts with Mnova objects

Simple access to an NMR spectrum

The examples we have shown so far are certainly not very useful. The good thing about scripting in Mnova is that it can be used to manipulate objects (e.g. spectra, molecules, pictures, etc) in Mnova and automated repetitive tasks. This section will explain how to access an NMR spectra from within the scripting framework.

Consider the following code snippet:

```
function dumpSpectrum()
{
    //To get the active spectrum
    var spectrum = nmr.activeSpectrum();
    //The function isValid informs about if the spectrum obtained is
correct
    print( spectrum.isValid() );
    //To print the spectrum information
    print( "Frequency: " + spectrum.frequency() );
    print( "Lowest Frequency: "+spectrum.hz() );
    print( "Real: "+spectrum.isReal );
    print( "Solvent: "+ spectrum.solvent );

    //To get information about each dimension
    var dCount = spectrum.dimCount;
    for( var i = 1; i <= dCount; i++ )
    {
        print( "Dimension "+i );
        print( "Nucleus: "+spectrum.nucleus(i) );
        //Spectral Size
        print( "Spectral Size: "+spectrum.count(i) );
    }
    //To print the value of one of the spectral points
    if( spectrum.isReal )
        print( spectrum.real(100) );
    else
        print( spectrum.real(100)+" + "+spectrum.imag(100)+"j" );
}
```

The first thing to note is the **nmr** object. This object gives access to the NMR plug-in framework and as such it allows you to get access to the NMR spectra in Mnova. For example, `nmr.activeSpectrum()` function makes it possible to select current active spectrum in Mnova. From that point, you can read relevant information of the NMR spectrum such as the number of points, spectral width, etc. For more information about the spectrum properties see the [reference](#).

Let's now move to a more comprehensive example which will illustrate, step by step, how to access all objects within an Mnova page.

Having access to multiple objects: the layout script

As an illustrative example, we will build a script which will make it possible to organize different objects contained within a page. This script will be called **layout** for obvious reasons.

To start off with, open a spectrum, a molecule and a picture (which could be, for example, your company logo). The following picture shows the initial conditions for this example:

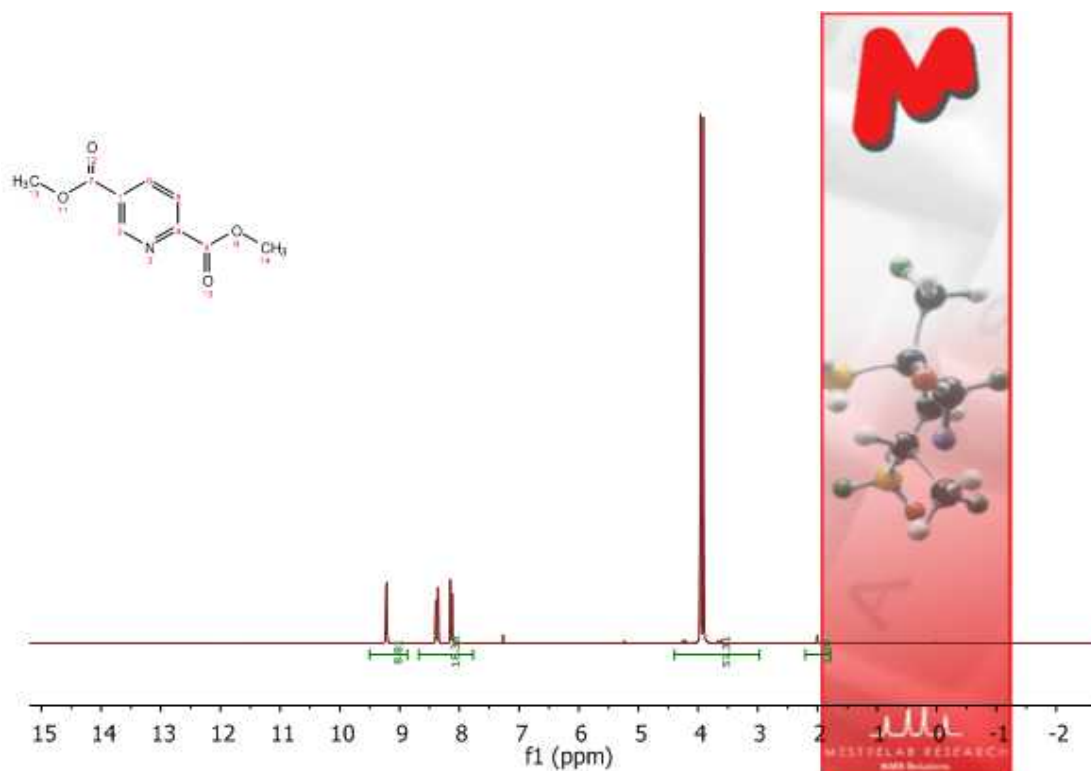

The goal here will be to create a script which will arrange these 3 objects in such a way that the picture will be located at the left side of the page whilst the spectrum and the molecule will be moved next to the picture.

```
// <GUI menuname="Layout" shortcut="Ctrl+2" tooltip="Layout" />
function layout()
{
    var w = new
DocumentWindow(Application.mainWindow.activeWindow());
    var p = new Page(w.curPage());
    var n = p.itemCount();

    for(i=0; i<n; i++)
    {
        var item = p.item(i);
        var width = item.width();
        var height = item.height();
        switch(item.name())
        {
            case "NMR Spectrum":
                item.left = p.left + 50;
                item.right = p.right - 10;
                item.top = p.top+20;
                item.bottom = p.bottom;

            break;
            case "Molecule":
                item.left = p.left + 50;
                item.right = item.left + width;
        }
    }
}
```

```
        item.top = p.top;
        item.bottom = p.top + height;
    break;
    case "Image":
        item.left = p.left;
        item.right = item.left + width;
        item.top = p.top;
        item.bottom = item.top + height;
    break;
    }
}
w.update();
}
```

Every object in Mnova is contained in a page which in turn is contained in a document. So the first thing we should get access to is the document. This is done in this line:

```
var w = new DocumentWindow(Application.mainWindow.activeWindow());
```

Basically we access to the document window ([DocumentWindow](#)) via the **Application** object. Once we have the document, we can easily access to the currently active page through [Page](#) object like this:

```
var p = new Page(w.curPage());
```

Now we are ready to navigate through all the objects contained in this page. For every object, the exact type is checked within the switch command and then the objects are repositioned accordingly. This is the result for this example.

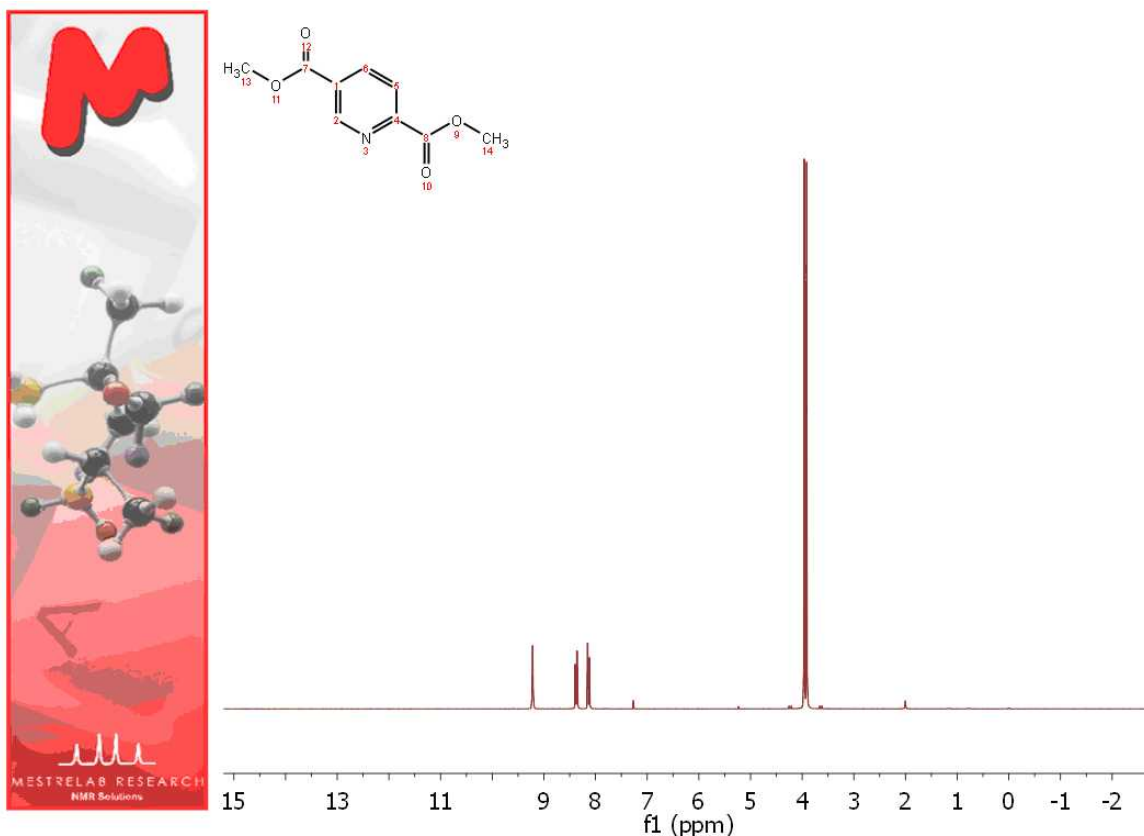

Tuning up the layout script

We will now modify the layout script in order to achieve the following two objectives:

1. Load the image from a file
2. Show the spectrum title automatically on the page when the script is executed

First off, we will show how to load an image from the disk. To do that, you have to use the [serialization](#) object. For example, assuming that the image is located in `c:\kk\logo.jpeg`, you can use this code:

```
serialization.open("c:\\kk\\logo.jpeg");
```

(Note the double back slash!).

Next thing is how to show the spectrum title on the page. In order to do that, it will be necessary to create a specialized NMR spectrum object rather than using the default properties available in every item object. See the following code snippet:

```
case "NMR Spectrum":
    var nmrSpc = new NMRspectrum(item);
    nmrSpc.left = p.left + 50;
    nmrSpc.right = p.right - 10;
    nmrSpc.top = p.top+20;
    nmrSpc.bottom = p.bottom;
    var tit = draw.text("<h3>"+nmrSpc.title+"</h3>", true);
    tit.left = p.left+50;
    tit.top = p.top;
break;
```

The first thing to note is the [NMR Spectrum](#) object. It will allow us to construct a specialized NMR spectrum object if a valid item is provided. From that point on, we will be able to change any spectrum properties or gain access to any of its elements such as the spectrum title. In this particular example we read the title using [nmrSpec.title](#) property which is then plotted with the draw.text command and moved to the top of the page next to the logo image.

It's important to note that in line

```
tit = draw.text("<h3>"+nmrSpec.title+"</h3>", true);
```

we are creating a new object (or item). This means that the array of items will not be the same now and the internal for loop will not longer be valid. One could think of just incrementing the number of items by one unit, but it's not guaranteed that the internal order of the objects is the same after inserting a new one. The simplest solution is to make a temporary copy of the original objects in the page (before creating the title object) as this:

```
var c = p.itemCount();
var i = 0;
var itemArray = new Array(c);
```

And then we can iterate through all these items:

```
for( i = 0; i<itemArray.length; i++ )
{
    var item = itemArray[i];
    // ...
}
```

The complete new script looks like this:

```
// <GUI menuname="Layout2" shortcut="Ctrl+2" tooltip="Layout2" />
function layout2()
{
    var w = new DocumentWindow(Application.mainWindow.activeWindow());
    var p = new Page(w.curPage());
    serialization.open("c:\\kk\\logo.jpeg");
    var c = p.itemCount();
    var i = 0;
    var itemArray = new Array(c);
    for(i=0; i<c; i++)
    {
        itemArray[i] = p.item(i);
    }
    for( i = 0; i<itemArray.length; i++ )
    {
        var item = itemArray[i];
        var width = item.width();
        var height = item.height();

        switch(item.name())
        {
            case "NMR Spectrum":
                var nmrSpc = new NMR Spectrum(item);
                nmrSpc.left = p.left + 80;
                nmrSpc.right = p.right - 10;
                nmrSpc.top = p.top+20;
                nmrSpc.bottom = p.bottom;
                var tit = draw.text("<h3>"+nmrSpc.title+"</h3>",
true);
```

```
        tit.left = p.left+50;
        tit.top = p.top;
        print(item.name());

    break;
    case "Molecule":
        item.left = p.left + 90;
        item.right = item.left + width;
        item.top = p.top+50;
        item.bottom = item.top + height;
        print(item.name());
    break;
    case "Image":
        item.left = p.left;
        item.right = item.left + width;
        item.top = p.top;
        item.bottom = item.top + height;
        print(item.name());
    break;
}

}
w.update();
}
```

Once you have the script saved (please bear in mind that the script file will need to have the same name as the function which you want to call, in this case the name of the script must be 'layout2.qs') in the Mnova scripts folder (and then have restarted the program), you will be able to add it to the toolbar just by following the menu: 'View/Toolbars/Customize Toolbars'. This will display the 'Customize Toolbars' dialog box. Then, click on the '+' button to create a new toolbar and type its name (Scripts Toolbar) by clicking on the 'Rename' button.

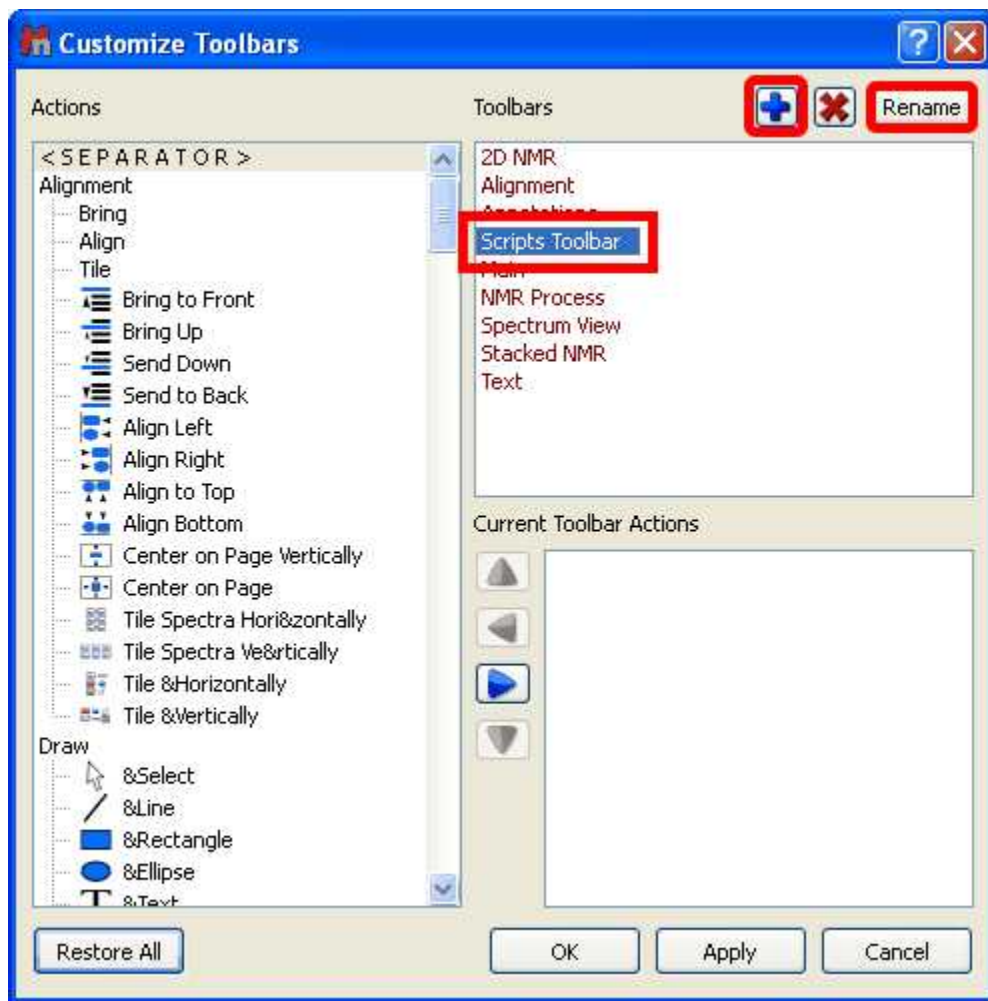

Next, navigate to the 'Script' icon (Layout2) in the 'Actions' menu (at the left-hand side of the window) and Click on the 'Right Arrow' button to add the 'Layout2' script to the 'New Toolbar'.

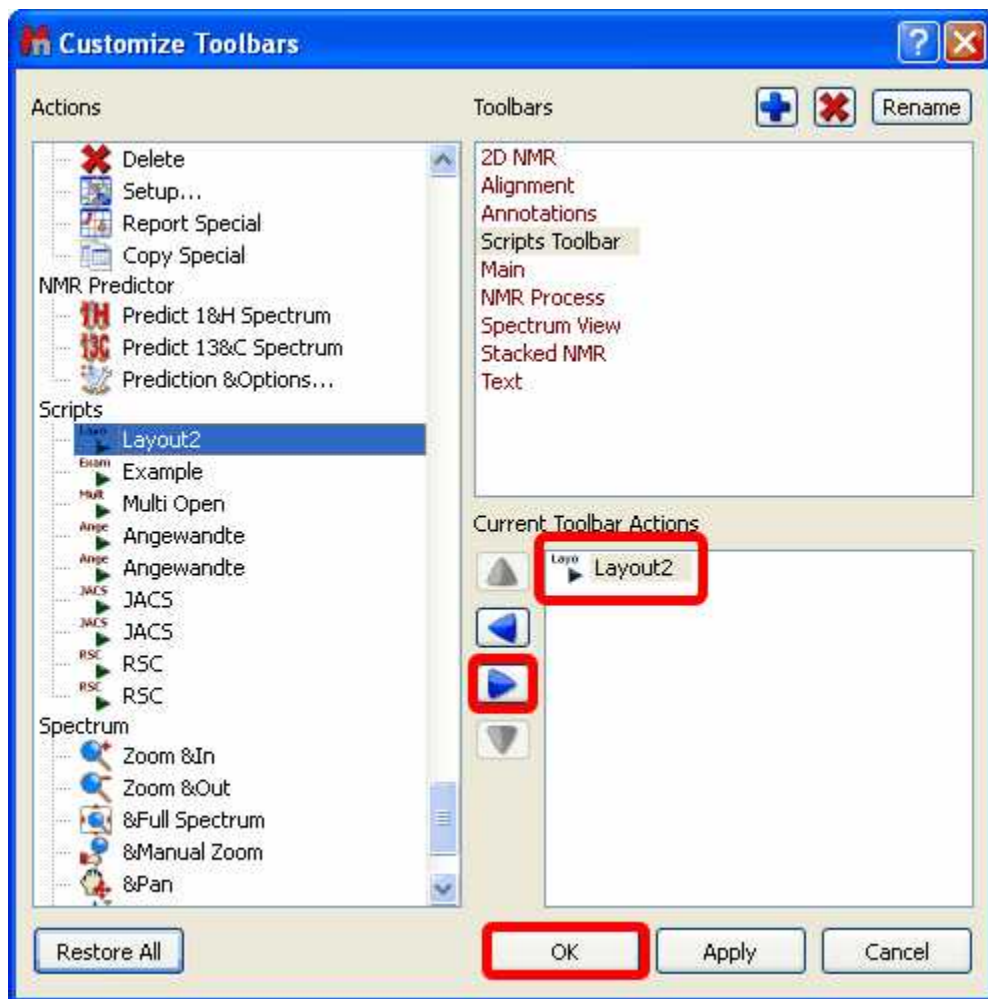

Finally, click on OK and you will be able to see the 'Layout2' icon in the 'New toolbar'. You will also be able to introduce the script in any existing contextual menu by following a similar procedure in the 'Customize Context menus' dialog box.

Custom NMR Processing

There are two ways to process NMR spectra via scripting:

1. By means of Processing Templates
2. By using the [Processing](#) interface

1 Processing templates

It is possible within Mnova to process a 1D or 2D NMR spectrum via scripting by using the processing templates (generated with the Full Processing feature). As you can see in the below example, you can process (with an easy script) any kind of spectrum (1H, 13C, 1D or 2D). You only need to create the processing template for each experiment. In the example below we have created 3 different processing templates, one for the processing of 1H-NMR spectra (1H.mnp), the second for the processing of 13C-NMR spectra (13C.mnp) and the last one for the processing of COSY spectra (COSY.mnp). As you can see in the scripts, the three the templates were saved at c:/kk/ (of course

you can change this path and also the name of the template files).

```
function procTemplate()
{
    var spec = new NMRspectrum( nmr.activeSpectrum() );
    var processing = new String;
    if (!spec.isValid())
        return;
    if (spec.dimCount == 1)
    {
        if (spec.nucleus() == "1H")
            processing = "c:/kk/1H.mnp";
        else if (spec.nucleus() == "13C")
            processing = "c:/kk/13C.mnp";
    }
    else if (spec.dimCount == 2)
    {
        if (spec.nucleus(1) == "1H" && spec.nucleus(2) == "1H")
            processing = "c:/kk/COSY.mnp";
    }
    nmr.processSpectrum(spec, processing);
}
```

2 Processing interface

The [Processing](#) interface makes it possible to change or apply any processing operation available in Mnova.

For example, let's make a simple script which will set an exponential weighting function:

```
function myProcess()
{
    var spec = new NMRspectrum( nmr.activeSpectrum() );
    var p = new NMRProcessing(spec.proc);

    p.setParameter("Apodization[1].Apply", true);
    p.setParameter("Apodization[1].Exp.Apply", true);
    p.setParameter("Apodization[2].Exp.Value", 0.5);
    print(p.getParameter("Apodization[1].Exp"));

    spec.proc = p;
    spec.process();
    mainWindow.activeWindow().update();
}
```

After creating a spectrum object which represents current active spectrum, we create a processing variable (p) which represents the processing operations for that particular spectrum. Once this new object is created, we can read or change its values using `getParameter` and `setParameter` functions. For instance, in this example we first set to true the Apodization property (otherwise no apodization will be applied) and then, after setting to true the exponential function, we set the line broadening to 0.5 Hz.

Finally, when we are done, we assign this processing object to the spectrum object (`spec.proc = p;`) and we call `spec.process();` to actually apply all the processing operations.

12.2 Connecting scripts with Mnova GUI

As you have seen in the examples above, it is possible to insert any script in the Mnova Scripts menu, contextual menus or toolbars.

The key to get this working lies in the first line of the script (and of course, in the fact that Mnova can locate the script as it has been saved in the appropriate folder):

```
// <GUI menuname= "MyProcess" shortcut="Ctrl+1" tooltip="Exponential
0.5" icon="C:/bin2.jpg" />
```

This line is used to instruct Mnova about the name to be displayed in the scripts menu along with the keyboard shortcut and the text used as a tooltip. Please bear in mind that the user is also able to use any created image file as icon. In this case, the name of the script is *MyProcess*, the shortcut is *Ctrl+1*, the tooltip is *Exponential 0.5* and the icon used was saved at *C:/bin2.jpg*.

You will be able to see in the picture below, that we have added the script 'MyProcess' to the 'Scripts' menu with the corresponding shortcut (Ctrl+1) and that we have introduced our own icon on the toolbar (red square in the picture below).

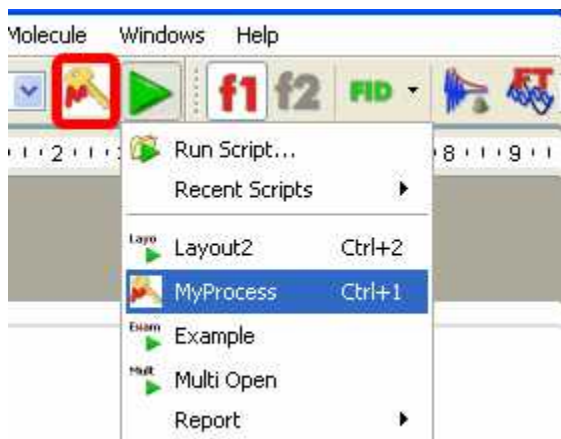

Please bear in mind that the script file will need to have the same name that the function which you want to call, in this case the name of the script must be 'MyProcess.qs', because the name of the function is: `myProcess()`.

12.3 Mnova processing scripts

This reference contains a list of objects, functions and properties supported by Mnova script. For a complete ECMAScript Reference, consult this link: <http://doc.trolltech.com/4.3/ecmascript.html>

Example scripts are present in the examples/scripts installation directory and some of them are described [here](#).

You can see [here](#) the Mnova script reference documentation, in the Mnova installation folder ('documents/scripts'), or by clicking on the 'Help' button in the scripts editor (or pressing F1 key).

NMRProcessing. Describing Processing parameters (Argument Strings).

You will find [here](#) (or in the Mnova installation folder: 'documents/scripts') a list of the argument strings (which have the form **function1.function2...functionN.parameter**) that you will be able to use in your processing scripts. These parameters appear in the graphical interface of the software (in the ')

Processing / Full Processing' menu) and are described in depth in the [manual](#) of Mnova.

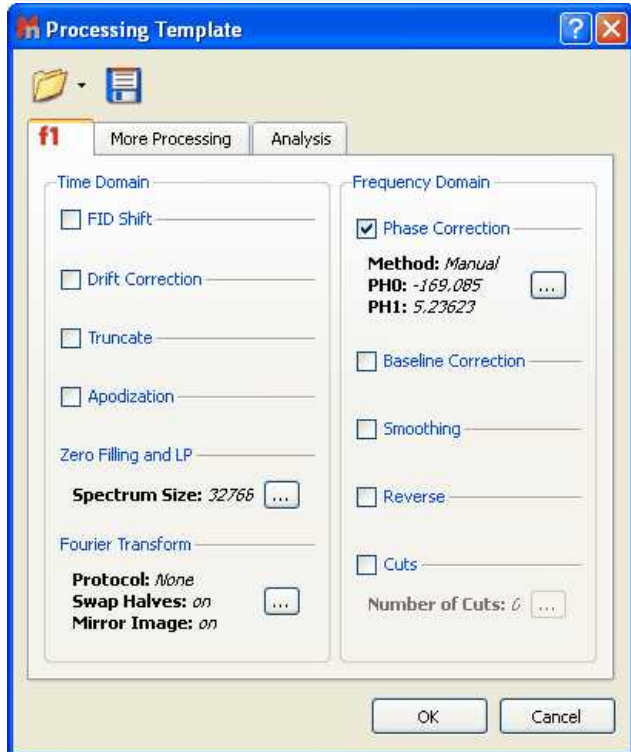
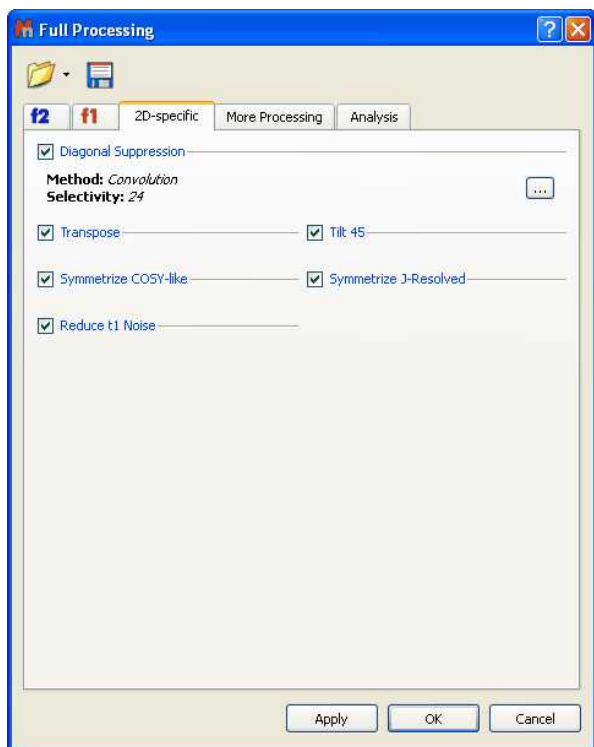

It is possible to run a saved processing template by running this easy script:

```

//<GUI menuname="ApplyProcessingTemplate"shortcut="Ctrl+2"tooltip="Apply a saved processing tem
function ApplyProcessingTemplate()
{
var spec = new NMRspectrum( nmr.activeSpectrum() );
var processing = new String;
if (!spec.isValid())
return;
processing = "C:\\\\ProcessingTemplate.mnp";
nmr.processSpectrum(spec, processing);
spec.process();
mainWindow.activeWindow().update();
}

```

Here you can see additional examples. This is a script to apply an Exponential apodization function of 0.5 Hz:

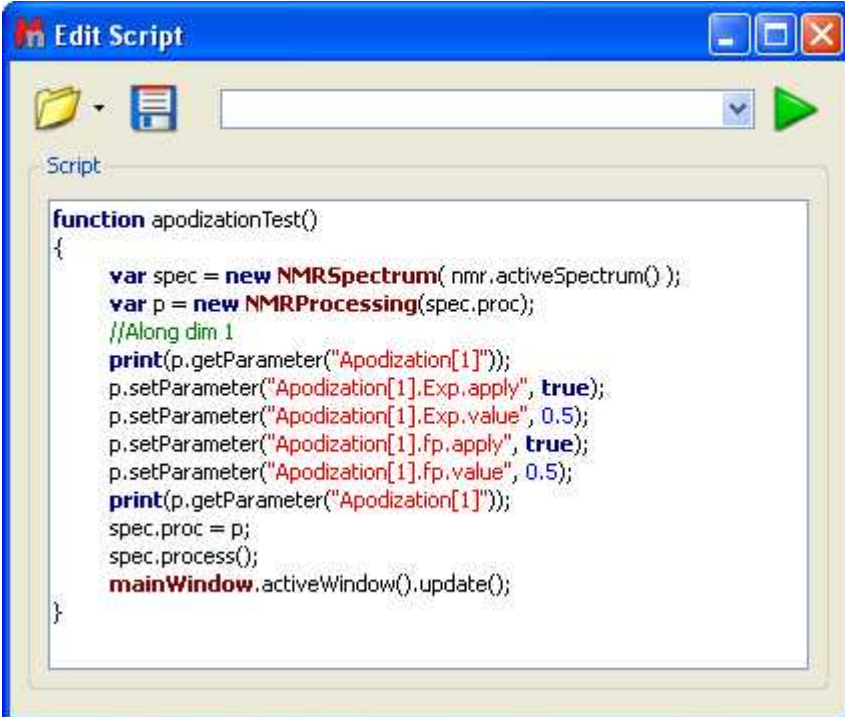

```

function apodizationTest()
{
    var spec = new NMRspectrum( nmr.activeSpectrum() );
    var p = new NMRProcessing(spec.proc);
    //Along dim 1
    print(p.getParameter("Apodization[1]"));
    p.setParameter("Apodization[1].Exp.apply", true);
    p.setParameter("Apodization[1].Exp.value", 0.5);
    p.setParameter("Apodization[1].fp.apply", true);
    p.setParameter("Apodization[1].fp.value", 0.5);
    print(p.getParameter("Apodization[1]"));
    spec.proc = p;
    spec.process();
    mainWindow.activeWindow().update();
}

```

Here you can see an example to Bin your spectra with 0.025 ppm:

```

1 function Binning()
2 {
3     var spec = new NMRpectrum( nmr.activeSpectrum() );
4     var p = new NMRProcessing(spec.proc);
5     print(p.getParameter("Binning"));
6     p.setParameter("Binning.apply", true);
7     p.setParameter("Binning.Full", true);
8     p.setParameter("Binning.Width", 0.025);
9     print(p.getParameter("Binning"));
10    spec.proc = p;
11    spec.process();
12    mainWindow.activeWindow().update();
13 }

```

This is an example to apply a phase correction:

```

function phaseCorrectionTest()
{
    var spec = new NMRpectrum( nmr.activeSpectrum() );
    var p = new NMRProcessing(spec.proc);
    print("Old Method: ", p.getParameter("PC.method"));
    p.setParameter("PC.method", "Global, Metabonomics");
    print("New Method: ", p.getParameter("PC.method"));
    // p.setParameter("PC.method", "Manual");
    // p.setParameter("PC.PHD", 0);
    // p.setParameter("PC.PH1", Math.PI / 2);
    spec.proc = p;
    spec.process();
    mainWindow.activeWindow().update();
}

```

And this script can be used to reference your spectra:

```
function referenceTest()
{
  var spec = new NMRspectrum( nmr.activeSpectrum() );
  var p = new NMRProcessing(spec.proc);
  print(p.getParameter("ref"));
  p.setParameter("ref.apply", true);
  p.setParameter("ref.shift", 2.2, 3.2); //( "ref.shift", oldShift, newShift)
  p.setParameter("ref.autotune", true); //if true, ref.tolerance will be used
  p.setParameter("ref.tolerance", 0.2);
  print(p.getParameter("ref"));
  spec.proc = p;
  spec.process();
  //var result = spec.process();
  //MessageBox.information("Process "+result);
  mainWindow.activeWindow().update();
}
```

You will find in the example/scripts folder a script called "customImportProcessing.qs", which will allow you to import your NMR spectra without applying any processing. If you add this script to a 'Script directory' you will obtain just the FID of your datasets.

You can also edit the "customImportProcessing.qs" script to always apply a baseline correction when you import a dataset.

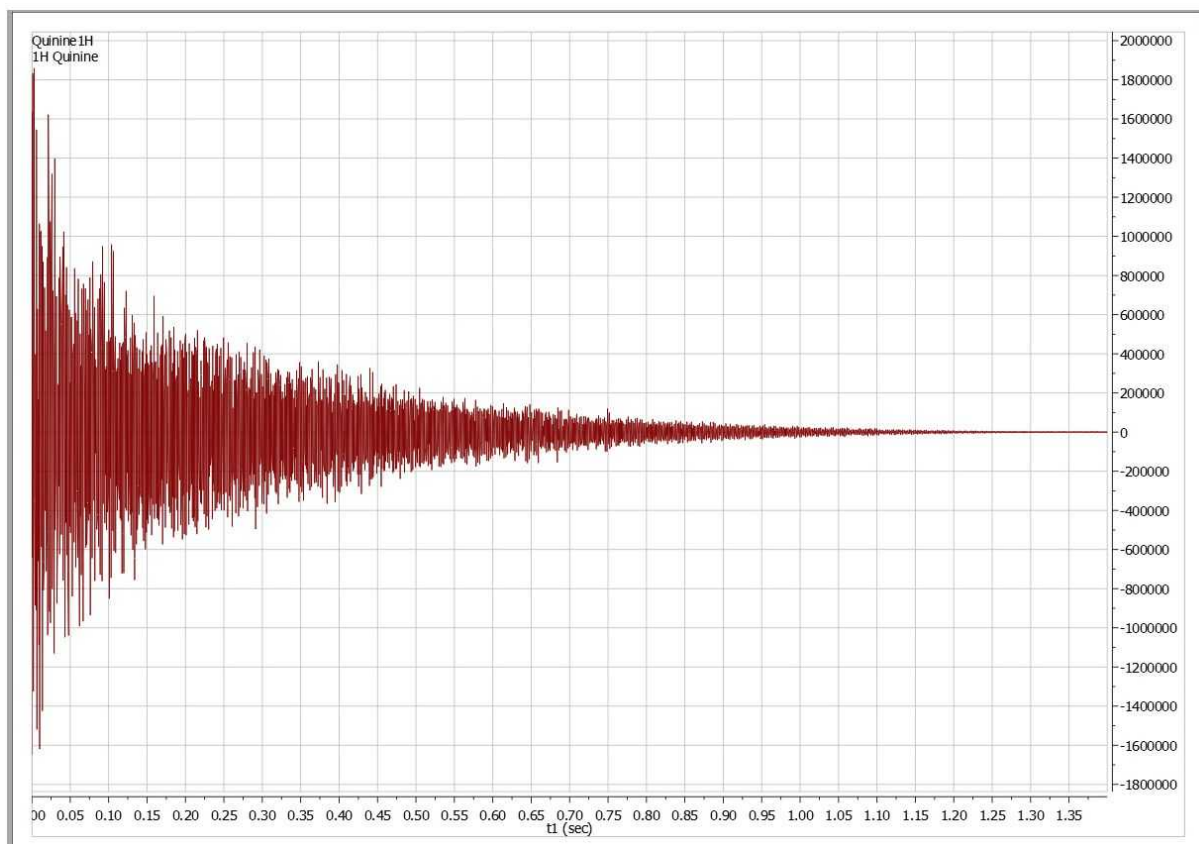

12.4 Mnova properties scripts

NMRSpectrum.getProperty/setProperty Arguments

You will find [here](#) (or in the Mnova installation folder: 'documents/scripts') the spectrum properties (**aParamName**) that you can manage via script, by using the functions '[SetProperty](#)' and '[GetProperty](#)'. You will find an example script in the examples/scripts installation directory and also in the '[Script Samples](#)' chapter. All of these properties can also be selected by using the GUI:

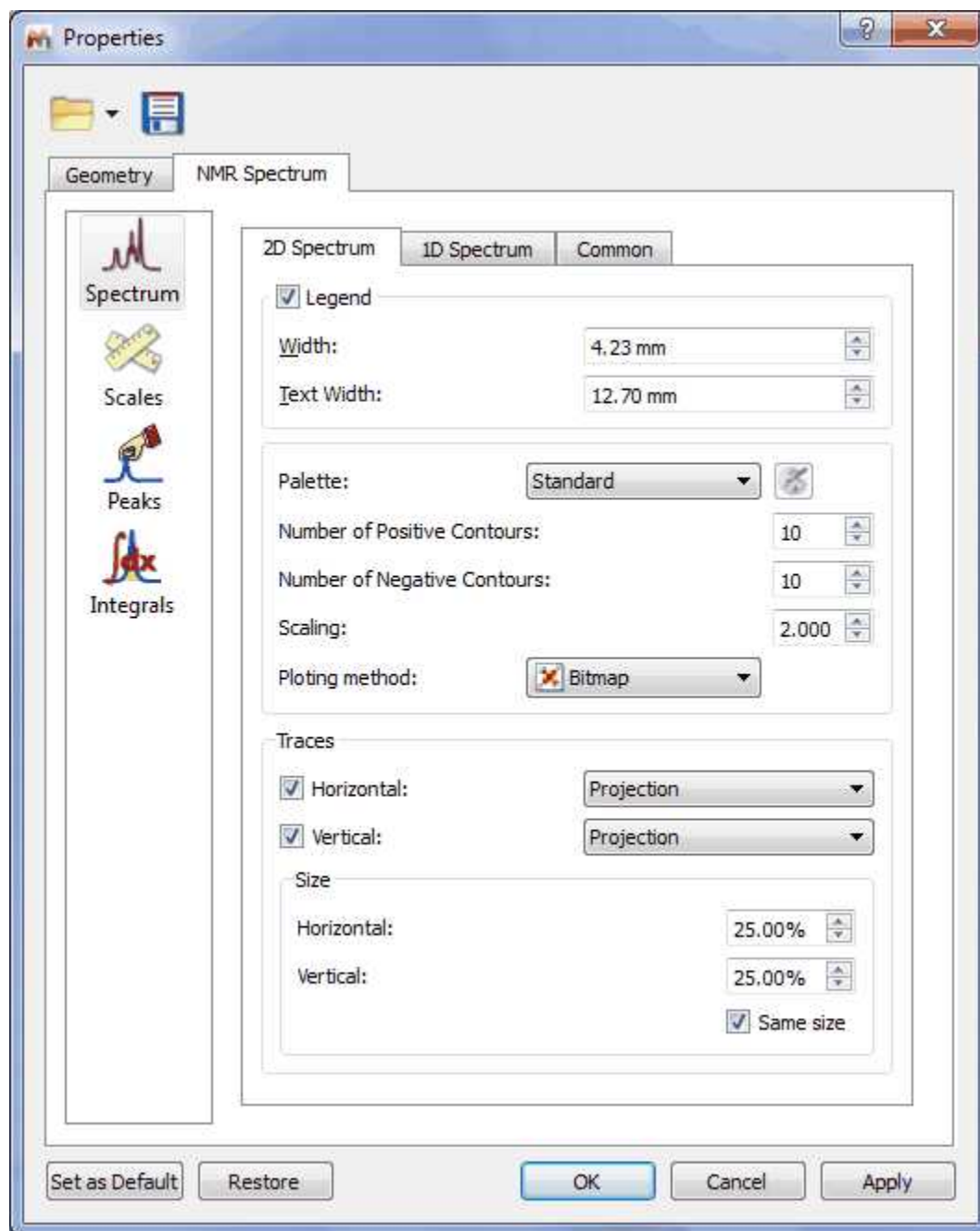

You will find below an example of a script to change some properties of your spectra. In this case, the colour of the spectrum will be changed to red, the peaks font to Arial and the integral curves will be shown.

```
function properties()
{
    var spec = new NMRspectrum(nmr.activeSpectrum());

    spec.setProperty("curve.color", "red");
    spec.setProperty("peaks.font", "Arial");
    spec.setProperty("integrals.curve.show", true);
    spec.update();
}
```

```
mainWindow.activeWindow().update();
}
```

12.5 GUI Actions

You will find [here](#) (or in the Mnova installation folder: 'documents/scripts') the GUI actions that you will be easily able to run with an easy script. The script below will apply an "Auto Peak Picking" analysis:

```
function doActionTest()
{
mainWindow.doAction("nmrAutoPeakPicking");
}
```

If you want to run any other action just replace the red action with any action of the the list below. Of course, you can add to the script as many actions as you want.

Here you can see an example of this tool to apply several actions to all the spectra opened in the same document:

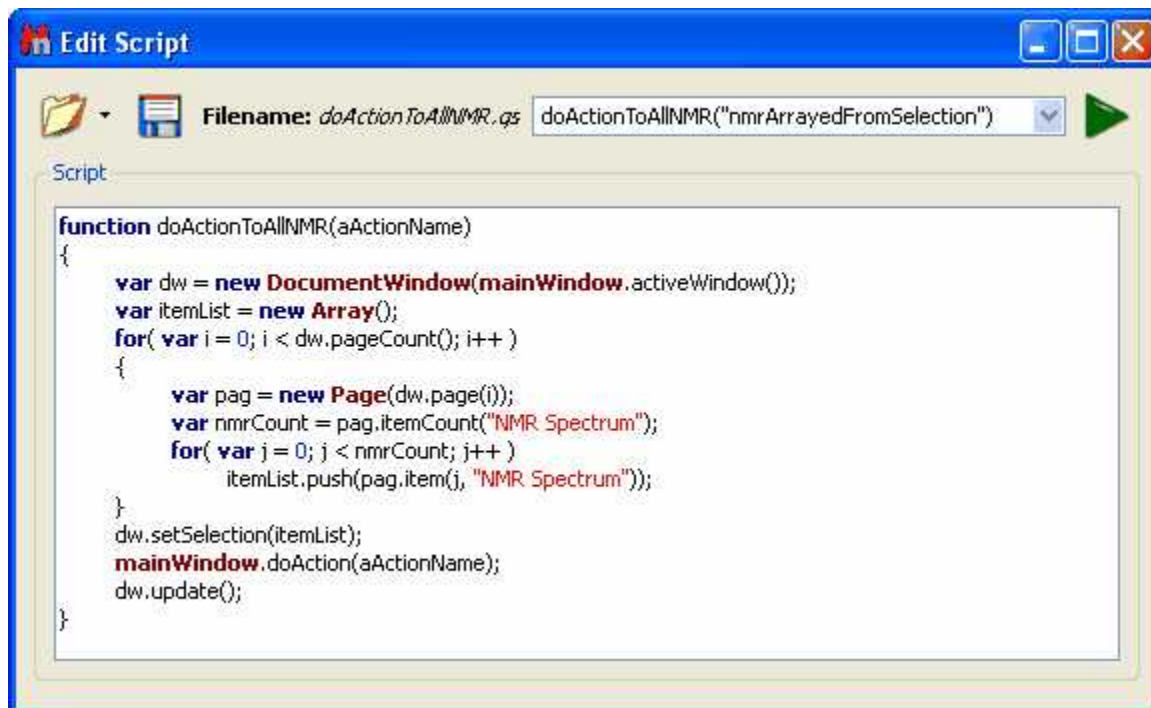

This script will generate a stack plot of all the opened spectra. You can use this script to run whatever doAction you o

12.6 Running Scripts from the command line

It is possible to run scripts from the command line, just by typing the path where the Mnova .exe file and the script are located and -sf "name of the script function": "**mestrenovaPathname**" "**scriptPathname**" -sf "**scriptFunctionToRun**"

For example:

1. mestrenova scriptPath

For example: mestrenova c:\temp\multiOpen.qs will run the function multiOpen() from multiOpen.qs

file, i.e. it runs a function with the same file name.

2. **mestrenova scriptPath -sf functionName,arg1,arg2,...,argN**

This runs functionName(arg1, arg2, ... argN) from the scriptPath file.

The below command line is doing the same as the above one:

mestrenova -sf functionName,arg1,arg2,...,argN scriptPath

Examples:

You can also use: **"mestrenovaPath" "scriptPath" -sf "scriptFunctionToRun"**

"C:\Program Files\Mestrelab Research S.L\MestReNova\MestReNova.exe" "C:\Program Files\Mestrelab Research S.L\MestReNova\scripts\myScript.qs" -sf "myFunction"

It is also possible to specify arguments:

"C:\Program Files\Mestrelab Research S.L\MestReNova\MestReNova.exe" "C:\Program Files\Mestrelab Research S.L\MestReNova\scripts\myScript.qs" -sf "myFunction",0.1,10,true,off

In this case, MNova will run myFunction(0.1,10,true,"off") from myScript.qs with the arguments specified. No spaces after commas!

3. **mestrenova -sf functionName,arg1,arg2,...argN**

In this case it is supposed that the function functionName is taken from one of the script directories, either MNova standard or user defined.

Note: Command line arguments are separated with white-spaces. This is why it is important not to use white-spaces after commas. If script arguments contain white-spaces then use quotes: "C:\Program Files\Mestrelab Research S.L\MestReNova\MestReNova.exe" -sf openSpecWithMols,"C:\1Hfid".

This doesn't need quotes: "C:\Program Files\Mestrelab Research S.L\MestReNova\MestReNova.exe" -sf openSpecWithMols,C:\1Hfid

Complex case example:

mestrenova specPath1 specPath2 -sf functionName,arg1,arg2 specPath3 specPath4

This will first open the spectra specPath1, specPath2, specPath3, specPath4. Next, apply the script: functionName(arg1, arg2)

There is also a single command line parameter **-w** (w stands for wait). If this parameter is present in the command line and there is no Mnova already running, then Mnova will open, load any files and run any scripts passed in the command line and, finally, it will close.

If this parameter is present but Mnova is already running, then the second Mnova instance will pass the command line information to the first running instance, the first running will load/run files/scripts and finally it will notify to the second instance that it has finished, so the second instance will close.

Some examples:

MestReNova.exe -w

Mnova not running: Mnova opens and closes immediately.

Mnova running: The second Mnova instance will return immediately.

MestReNova.exe myscript.qs -w

Mnova not running: Mnova opens run the myscript function in the myscript.qs file and closes when it

finishes.

Mnova running: A second Mnova instance is run and passes the parameters to the already running one. The `myscript` function from the `myscript.qs` file is run in the already running Mnova instance and when it finishes, notifies the second one and the second one Mnova instance (the one you have started from the command line) it closes.

12.7 Import spectra

There are some specific spectral formats (such as ACD Labs, LC Model ASCII, Philips Achieva or Siemens Syngo) which can only be imported in Mnova by using the scripting engine.

To import these kinds of spectra, just run Mnova, follow the menu `Scripts/Import` and select the desired format

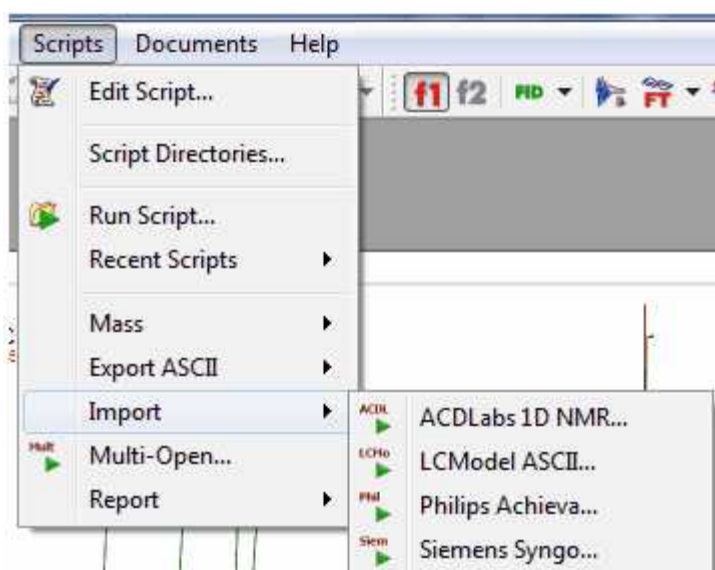

The user can use these scripts as a starting point to import any other spectral format. If you need help about it, just [contact us](#).

It will be possible to change the 'default import' options for your datasets, just by using the 'ImportProcessing' script. You will find an example of that script called "`customImportProcessing.qs`" in your Mnova installation folder. You can freely edit this script to make your own automatic import processing options or even you can create 'Processing Templates' that will be applied automatically over your spectra after having loaded them in Mnova.

12.8 Export as ASCII

It is possible to export NMR spectra with different ASCII format (Hz+Real, DmFit, FID, GSD Spectra, PPM+Real+Imaginary, etc) just by following the menu '`Scripts/Export ASCII`':

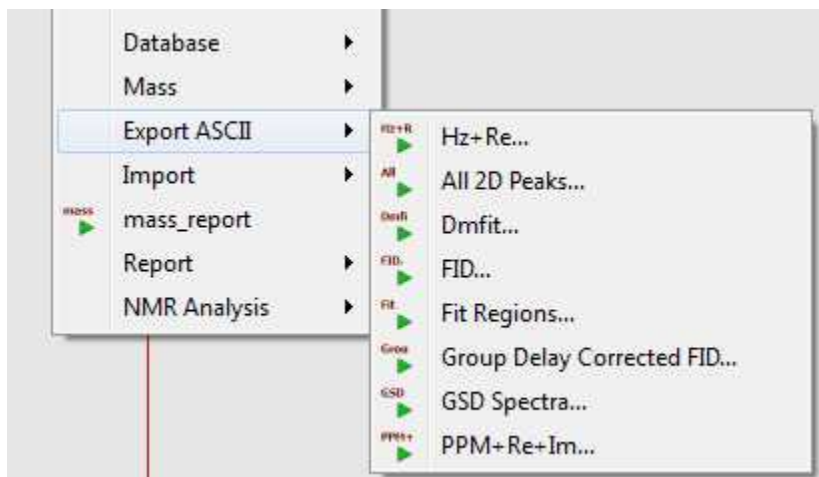

The script called '**Hz+Re**' will export the real part of your 1D NMR spectra with chemical shift in Hz, whilst the '**All 2D Peaks**' will export all the peaks of 2D datasets in the current document. The '**DmFit**' will export 1D-NMR spectra to Dmfit ASCII format. The '**FID**' script can be used to extract a XY text file for the FID. This script saves original FID independently on what is shown on the screen (FID, or FID', or FT Spectrum). The '**Fit Regions**' script will export the fit peaks to a text file. The '**GSD Spectra**' script will generate an ASCII file with the GSD peaks. The '**PPM+Re+Im**' will export the X-axis values for each real and imaginary pair in ppm.

12.9 Scripts Samples

Other Scripts samples:

All the scripts are present in the examples/scripts installation directory. Some of them will be described in this chapter. Please bear in mind that it is also possible to run scripts from the command line, just by typing the path where the Mnova .exe file and the script are located and -sf "name of the script function": "**mestrenovaPathname**" "**scriptPathname**" -sf "**scriptFunctionToRun**"

For example:

```
"C:\Program Files\Mestrelab Research S.L\MestReNova\MestReNova.exe" "C:\Program Files\Mestrelab Research S.L\MestReNova\scripts\myScript.qs" -sf "myFunction"
```

It is also possible to specify arguments:

```
"C:\Program Files\Mestrelab Research S.L\MestReNova\MestReNova.exe" "C:\Program Files\Mestrelab Research S.L\MestReNova\scripts\myScript.qs" -sf "myFunction",0.1,10,true,off
```

In this case, MNova will run myFunction(0.1,10,true,"off") from myScript.qs with the arguments specified. No spaces after commas!



Do not forget to visit our script repository at:
<http://mestrelab.com/scripts.html>

customImportProcessing: This script can be used to change the way of Mnova imports your NMR spectra. For example to stop the processing in the FID. Please follow the procedure below to set this script by default:

1: Go to 'Edit/Preference/Scripts' and add a new folder to sample scripts by clicking on the 'blue plus

button'

2: Save this [script](#) as a .qs file to the folder above.

3: Restart Mnova and load a 1H-NMR dataset. You will get your spectrum without any processing (just the FID).

Open and Save Document Script: Let's take a look at an easy script which you can use to open a .mnova file and export it as a PDF file. In this case, we will open a .mnova file named 'Dimethoxy':

```
function openSaveDocument()
{
    //If the open function gives a 'false', it will mean that Mnova does not recognize the file
    if( serialization.open("/dimethoxy.mnova") )
    {
        print("File Opened");
        //Let's see what the document contains
        //To get the active document
        var dW = new DocumentWindow(Application.mainWindow.activeWindow());
        //To get information about the number of the pages of the document
        print(dW.pageCount());
        //To print the number of items and the description of them for each page
        for( var i = 0; i < dW.pageCount(); i++ )
        {
            var pag = new Page(dW.page(i));
            print ( "Page number "+i+" has "+pag.itemCount()+" items" );
            for( var j = 0; j < pag.itemCount(); j++ )
            {
                var item = new PageItem(pag.item(j));
                print( "\t"+item.name );
                //If the item is an NMR spectrum, it will print "This is an NMR
                spectrum", if not, the function isValid will give a "False"
                var spectrum = new NMRspectrum(item);
                if(spectrum.isValid() )
                    print( "This is an NMR Spectrum" );
            }
        }
        //To save as a PDF file
        serialization.save("/dimethoxy.pdf", "pdf");
    }
}
```

To run this script, just copy it to the 'Edit Script' dialog box and type "openSaveDocument()" in the combobox. Please bear in mind that, you will need to write the corresponding path of the saved Mnova file in the line 4 of the script (in this case the **dimethoxy.mnova** file was saved in C:\).

As you can see in the script, if Mnova does not recognize the spectrum, you will obtain a 'False' message in the output due to the statement:

```
if( serialization.open("/dimethoxy.mnova") )
```

The line `print("File Opened");` will give the corresponding message in the output, as you can see in the picture below:

```

function openSaveDocument()
{
    //If the open function gives a 'false', it will mean that Mnova does not recognize the file
    if( serialization.open("/dimethoxy.mnova") )
    {
        print("File Opened");
        //Let's see what the document contains
        //To get the active document
        var dW = new DocumentWindow(Application.mainWindow.activeWindow());
        //To get information about the number of the pages of the document
        print(dW.pageCount());
        //To print the number of items and the description of them for each page
        for( var i = 0; i < dW.pageCount(); i++ )
        {
            var pag = new Page(dW.page(i));
            print ( "Page number "+i+" has "+pag.itemCount()+" items" );
            for( var j = 0; j < pag.itemCount(); j++ )
            {
                var item = new PageItem(pag.item(j));
                print( "\t"+item.name );
                //If the item is an NMR spectrum, it will print "This is an NMR spectrum", if not, the function isValid will give a "False"
                var spectrum = new NMRspectrum(item);
                if(spectrum.isValid() )
                    print( "This is an NMR Spectrum" );
            }
        }
        //To save as a PDF file
        serialization.save("/dimethoxy.pdf", "pdf");
    }
}

```

```

File Opened
2
Page number 0 has 1 items
    NMR Spectrum
This is an NMR Spectrum
Page number 1 has 5 items
    NMR Spectrum
This is an NMR Spectrum
    Molecule
    Arrow
    Rectangle
    Ellipse

```

The object 'Application' of the variable `var dW = new DocumentWindow(Application.mainWindow.activeWindow());` gives us the 'Active Window' of the 'Main Window', that is to say, the document which we can see in the screen. The function `print(dW.pageCount());` is used to know the number of the pages of the document.

The following lines of the script are used to obtain information about the items included on the document. For example the function `pageCount` is used to know the number of pages of the document. The variable `var pag = new Page(dW.page(i));` will analyze page by page to find the information. The line `print ("Page number "+i+" has "+pag.itemCount()+" items");` will print the corresponding phrase in the output, following the number of the page (+i) and the number of the items included in the page `for(var j = 0; j < pag.itemCount(); j++)`. The variable `var item = new`

PageItem(pag.item(j)); will inform about the type of the item, and the function **print** ("\\t"+item.name); will print the name of the item. In this example (as we can see in the output of the picture below), the document has 2 pages; page 0 has 1 item, which is an NMR spectrum and page 1, has 5 items (NMR Spectrum, molecule, arrow, rectangle and ellipse).

The variable **var spectrum = new NMRpectrum**(item); will rebuild the active spectrum, and if the item is an NMR spectrum, it will print "This is an NMR spectrum", if not, the function **isValid** will give a "False" due to the lines: **if**(spectrum.isValid()) // **print**("This is an NMR Spectrum");.

Finally, the plugin **serialization.save("/dimethoxy.pdf", "pdf");** will save the document as a PDF file in the specified location of the hard-disk (in this case, the PDF will be saved in C:\).

Open a spectrum with molecules:

It is possible to open spectra with molecules by using the **openSpecWithMols.qs** example script. You will need to add the directory where you have the script to the 'Scripts directories' (by using the 'Edit/Preferences/Scripting/Scripts Directories' menu). Then restart Mnova and you will be able to run the script from the command line by typing:

"MestReNova path" -sf openSpecWithMols, "Spectrum path"

For example:

```
"C:\Program Files\Mestrelab Research S.L\MestReNova\MestReNova.exe" -sf
openSpecWithMols, "C:\1H.fid"
```

Where, the yellow is the path where you have installed Mnova and the red is the path of the spectrum that you want to open.

```
// Opens a spectrum at aSpecPath and all the molfiles located in the same directory
function openSpecWithMols(aSpecPath)
{
var dirPath = File.absDirPath(aSpecPath);
var dir = Dir(dirPath);
dir.cdUp();
var files = getMaskFiles(dirPath, dir.absPath, "*.mol", "**", false);
files.push(dirPath);
serialization.open(files);
}
```

Import_Process_Save_Loop Script: This script can be used to apply a previously existing 'full processing' template (in this case, it is a template saved at C:/temp/proc.mnp) to several spectra (saved at C:/spectra/ and inside sub-folders with the extension ".fid", for example: "C:/spectra/1H.fid") and to save the result in different files formats (.mnova, .pdf and .txt). This script is only valid for these spectra containing a FID file.

```
/*****
```

```
Copyright (C) 2007 Mestrelab Research S.L. All rights reserved.
```

```
This file is part of the MNova scripting toolkit.
```

```
Authorized users of MNova Software may use this file freely, but this file is provided AS IS
with NO WARRANTY OF ANY KIND, INCLUDING THE WARRANTY OF DESIGN,
MERCHANTABILITY AND FITNESS
FOR A PARTICULAR PURPOSE.
```

```
*****/
```

```
// This example function demonstrates how to apply some processing to a set of spectral files and to
save the result in the different file formats.
```

```

function import_process_save_loop()
{
    const dirName = "c:/spectra"; // Source directory with spectra to be processed.
    const resultDirName = dirName; // Destination directory where processed spectra should be
put.
    const procName = "c:/temp/proc.mnp"; // Processing file. It must be created in the Full
Processing dialog of MestReNova.
    const fileMask = "fid"; // This mask specifies files to be processed.
    const dirMask = "*.fid"; // This mask specifies directories to be scanned for spectra.

    var dir = new Dir(dirName);
    if (!dir.exists)
    {
        MessageBox.critical("Directory " + dirName + " does not exist.",MessageBox.Ok);
        return;
    }
    dir.cdUp();

    // The below function getMaskFiles is located in the files.js script.
    // If you run import_process_save_loop from QSA Workbench then it is necessary to introduce
getMaskFiles to the interpreter by importing files.js.
    var files = getMaskFiles(dirName, dir.absPath, fileMask, dirMask, true);
    for(var i = 0; i < files.length; i++)
    {
        var dw = new DocumentWindow(Application.mainWindow.newWindow()); //
Create new document window
        if (serialization.open(files[i]))
        {
            nmr.process(procName);
            const toReplace = new RegExp("[/]", "g");
            fileName = resultDirName + "/" + files[i].replace(toReplace, "_"); // Generate a
filename for processed spectrum.
            serialization.save(fileName+".mnova", "mnova"); // MestReNova file format
            serialization.save(fileName+".pdf", "pdf"); // Adobe PDF file format
            serialization.save(fileName+".txt", "ascii"); // ASCII
            print(fileName); // Prints file name in the debug window
        }
        dw.close(); // Close document window of processed spectrum
    }
}

```

Parameters Script: This script can be used to obtain the desired parameters on your spectrum. You will be able to add or remove any parameter and to change the font by just using HTML code.

```

function spectrumParams()
{
    var spec = new NMRspectrum( nmr.activeSpectrum() );
    var htmlText = "<b>Nucleus</b>: %1 <br/> <b>Frequency: </b> %2 <br/> <b>Pulse
Sequence: </b> %3 <br/> <b>psLabel: </b> %4 <br/> <b>Solvent: </b> %5 <br/> <b>Title: </b> %6";
    var nuc = spec.getParam("Nucleus[1]");
    var freq = spec.getParam("Spectrometer Frequency");
    var seqfill = spec.getParam("Pulse Sequence");
    var psLabel = spec.getParam("psLabel");
    var Solvent = spec.getParam("Solvent");
}

```

```

var Title = spec.getParam("Title");
print(spec.getParam("Nucleus[1]"));
print(spec.getParam("Spectrometer Frequency"));
print(spec.getParam("Pulse Sequence"));
print(spec.getParam("psLabel"));
print(spec.getParam("Solvent"));
print(spec.getParam("Title"));
htmlText=htmlText.arg(nuc).arg(freq).arg(seqfill).arg(psLabel).arg(Solvent).arg(Title);
draw.text(htmlText, true);
}

```

In this case, the script will print the parameters Nucleus, Spectrum Frequency, Pulse Sequence, psLabel, Solvent and Title. Please bear in mind that getParam function returns only parameters which exist in the table of parameters (including invisible ones). Please make sure that you have these parameters included on the table of parameters (via customization dialog).

Fid Test Script: you will get information about the real and the imaginary part of the FID by running this script:

```

function fidTest()
{
    var spec = new NMRspectrum( nmr.activeSpectrum() );
    print(spec.fidImag(0));
    if( spec.fidSetImag(0,0) )
        print(spec.fidImag(0));
        print(spec.fidReal(0));
    if(spec.fidSetReal( 0, 0 ) )
        print(spec.fidReal(0));
    spec.process();
    mainWindow.activeWindow().update();
}

```

The command `print(spec.fidImag(0))` will return the value of the imaginary part of the FID at the *aIndex* point (in this case; 0. You can type any number from zero to the number of points of your spectrum), whilst the line `print(spec.fidReal(0));` will give you the value of the real component. The object *fidsetImag*; sets the imaginary value of the *aIndex* point of the spectrum fid.

Integral Test Script: This script can be used to get information about the integrals of the spectrum:

```

function integralTest()
{
    var spec = new NMRspectrum( nmr.activeSpectrum() );
    var intList = new Integrals(spec.integrals());
    print(intList);
    print(intList.count);
    print(intList.normValue);

    var myInt = new Integral(intList.at(0));
    print(myInt);
    print(myInt.rangeMax(1));
    print(myInt.rangeMin(1));
    if( spec.dimCount > 1 )
    {
        print(myInt.rangeMax(2));
        print(myInt.rangeMin(2));
    }
}

```

```

print("Integral Value "+myInt.integralValue());
print("Normalized value "+myInt.integralValue(intList.normValue));

var sReg = new SpectrumRegion(7.2, 7.5);
var newInt = new Integral( spec, sReg, false );
print(newInt);
print(newInt.integralValue());
spec.integrals().append(newInt);
spec.process();
}

```

The first part of the script is used to count the integrals and to report the normalized value applied to the integrals (in the list 'intList'). With the second part of the script, the user is able to select any integral of the list (in this case the integral which appears in the first position, if we wanted to select the second integral, we should have to type `var myInt = new Integral(intList.at(1));`). Then the script returns the absolute value and the limits of the selected integral. The third part of the script returns the absolute and the normalized value of the integral.

The last part of the script can be used to add a new integral to the list (in this case an integral with the spectral region from 7.2 to 7.5 ppm). the script reports the absolute value of this integral.

Multiplet Test Script: This script is valid to obtain information about the multiplets of the spectrum and also to apply a 'manual multiplet analysis':

```

function multipletTest()
{
    var spec = new NMRspectrum( nmr.activeSpectrum() );
    print(spec.multiplets());
    var sMult = new Multiplets(spec.multiplets());
    print(sMult.count);
    print(sMult.at(2));

    var sReg = new SpectrumRegion(7.0, 7.5);
    var mult = new Multiplet( spec, sReg );
    var myMultiplets = new Multiplets();
    myMultiplets.append( mult );

    var mult2 = new Multiplet( spec, new SpectrumRegion(3.80,3.90) );
    myMultiplets.append( mult2 );

    var nM = new Multiplet(new SpectrumRegion(3.65,3.75), "t");
    nM.name="My mulltiplet";
    myMultiplets.append(nM);

    print(myMultiplets);
    spec.setMultiplets(myMultiplets);
    print(spec.multiplets());
    spec.process();
}

```

The first part of the script creates a list of the multiplets which appear on the spectrum and prints some information about the selected multiplet (in this case, the multiplet number 2, but of course you can select any other multiplet). The second part of the script creates a multiplet in the selected region 'sReg' (in this case the region is 7.0-7.5 ppm. It works as a manual multiplet analysis). Then, it creates a new empty list of multiplets which is added.

The third part of the script consists in a new region (from 3.80 to 3.90 ppm) to apply the multiplet analysis. The following part of the script is used to add a multiplet manually to the multiplet list (the user will be able to remove this part of this script without any problem). In this case, we wanted to add a triplet, which appears in the region from 3.65 and 3.75 ppm, with the name 'My multiplet'.

The end of the script is used to replace the original multiplet list for the list which we have just created.

Peak Test Script: A similar script used to obtain information about the chemical shift and the intensity of the peaks of a 1D-NMR spectrum:

```
function peakTest()
{
    var spec = new NMRspectrum( nmr.activeSpectrum() );
    var sR = new SpectrumRegion( 0, 9.5 );
    var ps = new Peaks(spec, sR); //fill the list with the peaks in sR
    print(ps);
    var p = new Peak(1.265, spec);
    print(p);
    ps.append(p);
    spec.setPeaks(ps); //Set the peaks to ps
    print( spec.peaks());
    spec.process();
}
```

After running this script, we will get the peak picking analysis of a 1D-NMR spectrum from 0 to 9.5 ppm (of course, we will be able to change this range). Then, a new peak at 1.265 ppm will be added to the peak list (again, you can add any other peak, if you want), reporting the intensity value of this new peak. Finally, the spectrum will be re-analyzed to obtain the new number of peaks.

A similar script can be used for a 2D-NMR spectrum, but in this case we have to type the corresponding spectrum region in 2D mode:

```
function peakTest()
{
    var spec = new NMRspectrum( nmr.activeSpectrum() );
    var sR = new SpectrumRegion(4.0, 3.5, 75, 65 );
    var ps = new Peaks(spec, sR); //fill the list with the peaks in sR
    print(ps);
    var p = new Peak(72.73, 3.17, spec);
    print(p);
    ps.append(p);
    spec.setPeaks(ps); //Set the peaks to ps
    print( spec.peaks());
    spec.process();
}
```

Multiplet Reporter script: Let's take a look now at a very important part of the 'Multiplet Reporter_JACS' script:

```
// This function defines JACS-like multiplet report.
// To customize report, edit this class or implement another one.
function JACSMultipletReporter()
{
    MultipletReporter.call(this);
}
```



```

this.onlyElementName=false;
// Define font size and font family
this.font = "<font style=\"font-size: 10pt; font-family: Times New Roman\">";

this.nucleusTemplate="%1";
// Report header. %1 will be replaced with nucleusString, %2 with frequency, %3 with solvent
this.header = "%1 NMR (%2 MHz, %3) &delta; ";

// Multiplet templates. %1 - delta, %2 - category, %3 - nH
this.reportRange = true; // set to true to get multiplet range instead of delta.
this.withoutJsTemplate = " %1 (%2, %3H)"; // multiplet template without J's
this.withJsTemplate = " %1 (%2, %4, %3H)"; // multiplet template with J's
this.rangeTemplate = "%1 &ndash; %2";

// J's list template. %1 - list of J's
this.jListTemplate = "<i>J</i> = %1";

this.jPrecision = 1; // J's precision
this.deltaPrecision = 2; // delta precision
this.mSeparator = ", "; // multiplet separator
this.jSeparator = ", "; // J's separator

this.start = this.font;
this.end = ".</font>";
}

JACSMultipletReporter.prototype = new MultipletReporter();
JACSMultipletReporter.prototype.toString = function() { return "JACSMultipletReporter()"; }

(...)

```

The user will be able to change the multiplet report template to obtain the desired multiplet report; for example:

this.onlyElementName=false; changing false with true, we will obtain only the element name without the atomic mass (For example: H, C instead of ¹H, ¹³C).

The function: **this**.font = ""; will define the font size and the font family of the multiplet report.

The line: **this**.header = "%1 NMR (%2 MHz, %3) δ "; is used to print the header of the report, where %1 will be the nucleus (H or C), %2 the frequency of the spectrometer (in MHz), and %3 the solvent, followed by a delta symbol (δ). For example: ¹H NMR (500 MHz, CDCl₃) ".

The sentence: **this**.reportRange = true is used to obtain the multiplet range instead of the chemical shift.

The functions: **this**.withoutJsTemplate = " %1 (%2, %3H)" and **this**.withJsTemplate = " %1 (%2, %4, %3H)" are used to customize the appearance of the multiplet report by changing the positions of %1, %2, %3H, or %4 (where, %1 means: chemical shift; %2 means: type of multiplet (s, d, t, etc); %3H means: number of hydrogens and %4 means the coupling constant value). As you can see, the first line shows a multiplet without coupling constants, (while the last line shows a multiplet with coupling constants).

So, if you need to obtain something like this (Japanese format):

1H NMR (300 MHz, Solvent) δ ppm 6.43-6.22 (1 H, m), 3.17 (1 H, q, $J = 7.15$ Hz) etc...

You should modify both lines, as you can see below:

```
this.withoutJsTemplate = %1 (%3H, %2);
this.withJsTemplate = " %1 (%3H, %2, %4)";
```

If you prefer to obtain something like this:

1H NMR (300 MHz, Solvent) δ ppm 1.23 (d, $J = 1.2$ Hz, 3 H), etc...

Just replace the original lines with:

```
this.withoutJsTemplate = %1 (%2, %3H);
this.withJsTemplate = " %1 (%2, %4, %3H)";
```

To obtain the coupling constant symbol in normal instead of *italic*, just modify the script by removing the italic format (<i>J</i>). If you prefer to obtain it in **bold** just type:

```
this.jListTemplate = "<b>J</b> = %1";
```

The following paragraph will be used to customize the appearance of the coupling constants list:

```
this.jPrecision = 1; // J's precision
this.deltaPrecision = 2; // delta precision
this.mSeparator = ", "; // multiplet separator
this.jSeparator = ", "; // J's separator
```

The first line is used for the precision of the coupling constants values, the second will be used for the precision of the chemical shift and the remaining two lines will print the separation between the multiplets and the coupling constants values.

If you need to obtain the coupling constants in descending order, replace 'true' with 'false' in the following line:

```
var jList = new JList(multiplet.jList());
jList.sort(true);
```

If you want to obtain the multiplet chemical shifts in ascending order, just replace the 'false' with 'true' in the script:

```
var multiplets = new Multiplets(spectrum.multiplets()); // get multiplets from
spectrum
jList.sort(true);
```

To obtain the multiplet range in ascending order, just replace the rangeMin with rangeMax (and vice versa) in the line below of the script:

```
shiftStr = this.rangeTemplate.argDec(multiplet.rangeMax, 0, 'f', this.deltaPrecision).argDec(multiplet.
rangeMin, 0, 'f', this.deltaPrecision);
```

Title and Solvent: running this script, you will get the title and the solvent on your spectrum

```
// <GUI menuname="title1" shortcut="Ctrl+2" tooltip="Title_and_Solvent"
/>
function title1()
{
//To get the active spectrum
    var spectrum = nmr.activeSpectrum();
//The function isValid informs about if the spectrum obtained is
correct
    print( spectrum.isValid() );
    var tit = draw.text("<h3>"+ spectrum.title+"
"+spectrum.solvent+"</h3>", true);
}
```

Zoom: This script can be used to apply a zoom into a selected range of a spectrum. In order to select the horizontal range, just type the desired values between the brackets on the line `spc.horZoom(1.0, 5.0);`

If you want to set the vertical zoom, just change the values of the line `spc.vertZoom(-100, 7000)`

```
function spectrumZoom()
{
    var spc = nmr.activeSpectrum();
    if( !spc.isValid() )
        return;
    spc.horZoom(1.0, 5.0);
    spc.vertZoom(-100, 7000);
    spc.update();
    mainWindow.activeWindow().update();
}
```

Properties Script: You will find below a script example to change some properties of your spectra. In this case, the colour of the spectrum will be changed to red, the peaks font to Arial and the integral curves will be showed. You will find all the available properties at the ['Mnova Properties'](#) chapter:

```
function properties()
{
    var spec = new NMRspectrum(nmr.activeSpectrum());

    spec.setProperty("curve.color", "red");
    spec.setProperty("peaks.font", "Arial");
    spec.setProperty("integrals.curve.show", true);
    spec.update();
    mainWindow.activeWindow().update();
}
```

Cutting: This script can be used to apply cuts to the spectra. You will obtain two cuts in your spectrum, between 1.0-3.5 and 7.0-8.0 ppm respectively.

```
function myProcess()
{
    var spec = new NMRspectrum( nmr.activeSpectrum() );
```

```
var p = new NMRProcessing(spec.proc);
var regs = new Array(2);
regs[0] = new SpectrumRegion(1.0, 3.5);
regs[1] = new SpectrumRegion(7.0, 8.0);
print(p.getParameter("cuts"));
p.setParameter("cuts.apply", true);
p.setParameter("cuts.list", regs);
spec.proc = p;
spec.process();
mainwindow.activeWindow().update();
}
```

Processing script: Here you can see a part of the 'mnrProcessingTest" script stores under the examples folder:

```

function apodizationTest()
{
    var spec = new NMRpectrum( nmr.activeSpectrum() );
    var p = new NMRProcessing(spec.proc);
    //Along dim 1
    print(p.getParameter("Apodization[1]"));
    p.setParameter("Apodization[1].Exp.apply", true);
    p.setParameter("Apodization[1].Exp.value", 0.5);
    p.setParameter("Apodization[1].fp.apply", true);
    p.setParameter("Apodization[1].fp.value", 0.5);
    print(p.getParameter("Apodization[1]"));
    spec.proc = p;
    spec.process();
    mainWindow.activeWindow().update();
}

function phaseCorrectionTest()
{
    var spec = new NMRpectrum( nmr.activeSpectrum() );
    var p = new NMRProcessing(spec.proc);
    print("Old Method: ", p.getParameter("PC.method"));
    p.setParameter("PC.method", "Global, Metabonomics");
    print("New Method: ", p.getParameter("PC.method"));
    // p.setParameter("PC.method", "Manual");
    // p.setParameter("PC.PH0", 0);
    // p.setParameter("PC.PH1", Math.PI / 2);
    spec.proc = p;
    spec.process();
    mainWindow.activeWindow().update();
}

function referenceTest()
{
    var spec = new NMRpectrum( nmr.activeSpectrum() );
    var p = new NMRProcessing(spec.proc);
    print(p.getParameter("ref"));
    p.setParameter("ref.apply", true);
    p.setParameter("ref.shift", 2.2, 3.2); //("ref.shift", oldShift, newShift)
    p.setParameter("ref.autotune", true); //if true, ref.tolerance will be used
    p.setParameter("ref.tolerance", 0.2);
    print(p.getParameter("ref"));
    spec.proc = p;
    spec.process();
    //var result = spec.process();
    //MessageBox.information("Process "+result);
    mainWindow.activeWindow().update();
}

```

Magnitude Active Spectrum script: Let's see another script; in this case this script is used to obtain the 1D-NMR spectra in magnitude. Just open a 1D-NMR spectrum in Mnova, load this script by

following the menu 'Script/Edit Script', type "magnitudeActiveSpectrum()" in the edit box and click on the green triangle to run the Script. You will obtain automatically your 1D-NMR spectrum in magnitude.

Please bear in mind that it is also possible to run scripts from the command line, just by typing the path where the Mnova .exe file and the script are located and -sf "name of the script function":
"mestrenovaPathname" "scriptPathname" -sf "scriptFunctionToRun"

For example:

```
"C:\Program Files\Mestrelab Research S.L\MestReNova\MestReNova.exe" "C:\Program Files\Mestrelab Research S.L\MestReNova\scripts\magnitudeActiveSpectrum.qs" -sf "magnitudeActiveSpectrum"
```

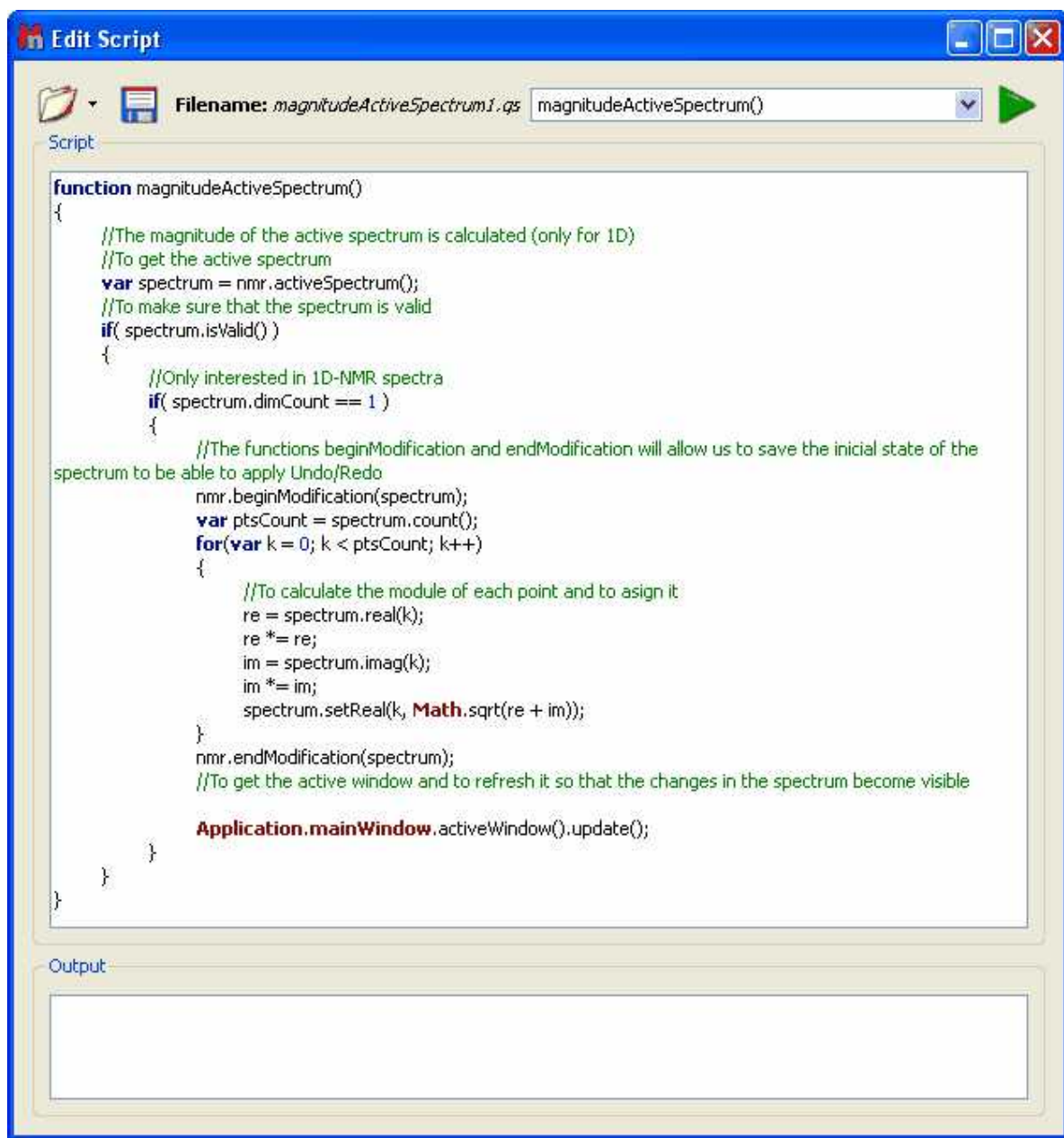

Threshold Script: This script will allow the user to adjust the threshold of the color scheme in 2D-NMR spectra:

```
// <GUI menuname="threshold2D" shortcut="Ctrl+T" tooltip="threshold2D" />
function threshold2D()
{
  var spectrum = nmr.activeSpectrum();
  if(!spectrum.isValid() )
    return

  var th = spectrum.threshold;

  var dlg = new Dialog();
  dlg.title = "Threshold";

  var edit = new LineEdit();
  edit.label = "Threshold";
  edit.text = th;
  dlg.add(edit);
  if (dlg.exec())
  {
    spectrum.threshold = edit.text;
  }
  spectrum.update();

  mainWindow.activeWindow().update();
}
```

Running this script will show the 'Threshold' dialog box. From this window, the user will be able to adjust the threshold of the colour scheme by just typing the desired value and clicking on the 'OK' button.



ProcessTest Script: This script can be used to get some data from Mnova, save it as a file, next run some external program in order to make calculations (or whatever you need) and once the external program finishes, Mnova will get the result from another file. In this case the external program is the 'Notepad'.

```
function processTest()
{
  fileName = Dir.temp() + "Mnova_Process_Text.txt";
  var f = new File(fileName);
  f.open(File.WriteOnly);
  var s = TextStream(f);
  s.write("Hello Notepad!");
  f.close();
  print(Process.execute("notepad.exe", fileName));

  f.open(File.ReadWrite);
}
```

```

s.pos = f.size;
print(s);
s.write("\r\nHi again!");
f.close();
print(Process.startDetached("notepad.exe", fileName));
}

```

MultiOpen script: Mnova incorporates a script named 'MultiOpen' (under the 'Scripts/Import' menu). This tool is very useful if, for example, you always process your spectra in the same way, or when you have to routinely handle a large number of datasets.

'Multiopen script' allows to open simultaneously a collection of several spectra. Make sure that all spectra are located in the same folder. After that, select 'Run Script...' on the 'Script Menu' or click on



the **'Run Script'** icon on the toolbar and then click 'Ok' after finding the corresponding script (in this case, the script is called 'multiOpen'). Then, select the directory where the spectra are located and a window like the one below will open:

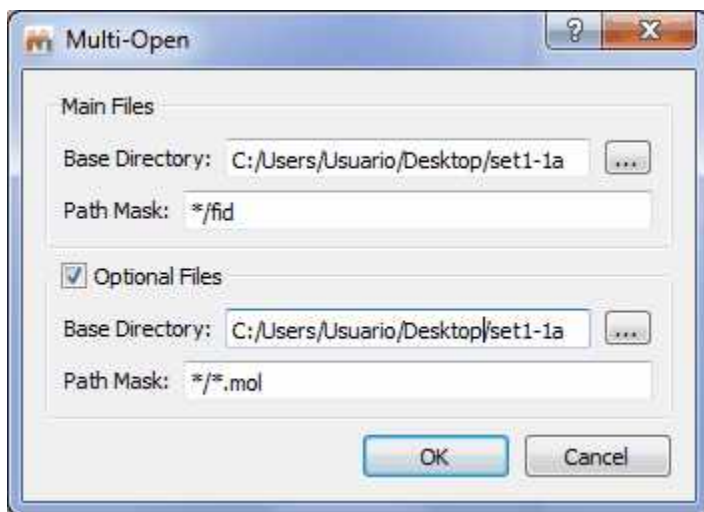

Finally, write the 'Path Mask' name (you can use wildcards, so this could be, for example, */10/pdata/1r, or just */fid, or */ser), and click 'OK'. All selected spectra will open simultaneously.

The user can also use the 'Full Processing' command to automate the processing of both 1D & 2D NMR data sets. (You can find a full description of this tool further on in the [Automated Processing](#) chapter.)

You can also extend this script to run batch predictions. Please [email us](#) if you need such script.

Signal to Noise Ratio

In order to calculate the SNR the user needs to run a script (located under the 'Scripts/NMR Tools' menu) to get the noise level and then calculate the SNR by measuring the height of a peak and dividing this value by the noise level.

After running the script, it's necessary to select the region of the spectrum (or just a single peak) where you want to calculate the Signal to Noise Ratio. Once this is done, the program will populate the 'comment' section in the Peak List table with the SNR values.

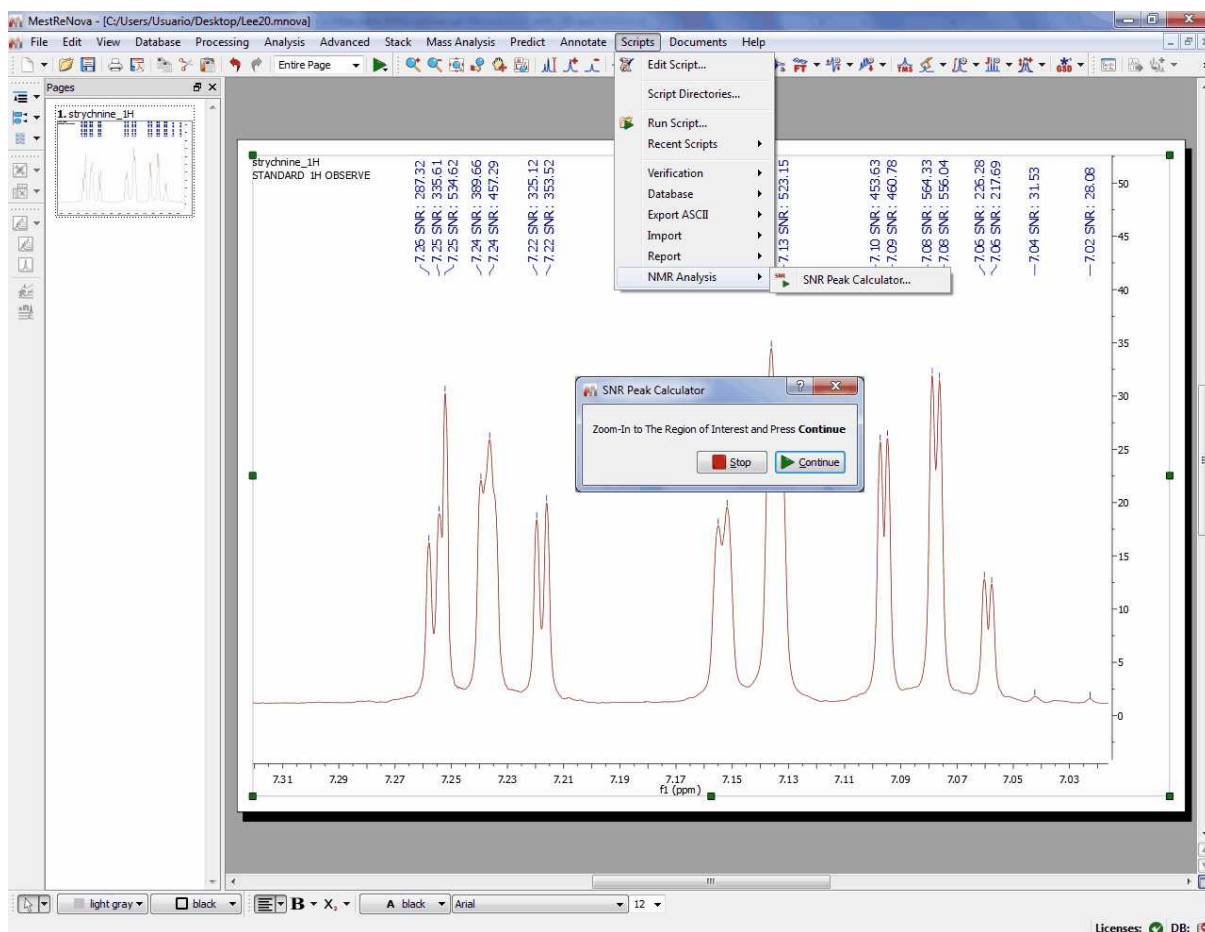

The script to calculate the SNR needs to have two parameters:

- 1) The noise value
- 2) The peak intensity

Then it calculates the SNR using a ratio between those parameters.

Mnova calculates the noise value (1) fully automatic (which is different with Bruker); I mean, the user does not need to select any region of the spectrum. With respect to the peak intensity, the script uses the peaks in this way:

1. If the user did a manual peak picking (or Peak by Peak or an automatic PP), the program will use those peaks in the zoomed region.
2. If the user did not applied any PP, the script will apply it for the user over the selected region using the automatic PP options.

Part

XIII

13 Tutorials

The goal of the present chapter is to give you a fast introduction to the basic analysis tools which are commonly used to solve structural problems. Not everything is explained in detail; the rest of the manual provides a more comprehensive description of all topics covered here.

13.1 Importing Spectrum Parameters

(Not available in Mnova Lite)

The 'Importing Spectrum Parameters' feature will allow Mnova users to include any variable into the Parameters Table from the raw data file. In addition, the users will be able to create 'Parameters Templates' in order to obtain the same parameters in all of their processed spectra. Before this feature was implemented, only standard spectrum parameters could be included in the corresponding table.

The user will easily be able to add, create, remove or modify any spectrum parameter or even to create templates in order to obtain the same parameters in any processed spectra.

Customization of the parameters table in Mnova is very intuitive, just follow the menu: View/Tables/Parameters and click on the 'Customize' icon to display the 'Customize Parameters' dialog box.

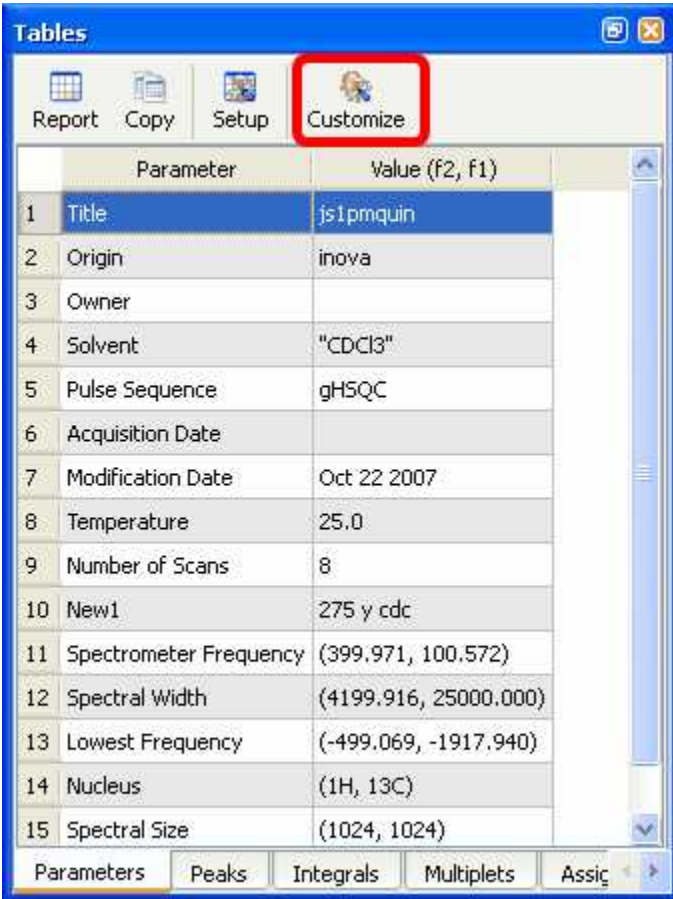

	Parameter	Value (f2, f1)
1	Title	js1pmquin
2	Origin	inova
3	Owner	
4	Solvent	"CDCl3"
5	Pulse Sequence	gHSQC
6	Acquisition Date	
7	Modification Date	Oct 22 2007
8	Temperature	25.0
9	Number of Scans	8
10	New1	275 y cdc
11	Spectrometer Frequency	(399.971, 100.572)
12	Spectral Width	(4199.916, 25000.000)
13	Lowest Frequency	(-499.069, -1917.940)
14	Nucleus	(1H, 13C)
15	Spectral Size	(1024, 1024)

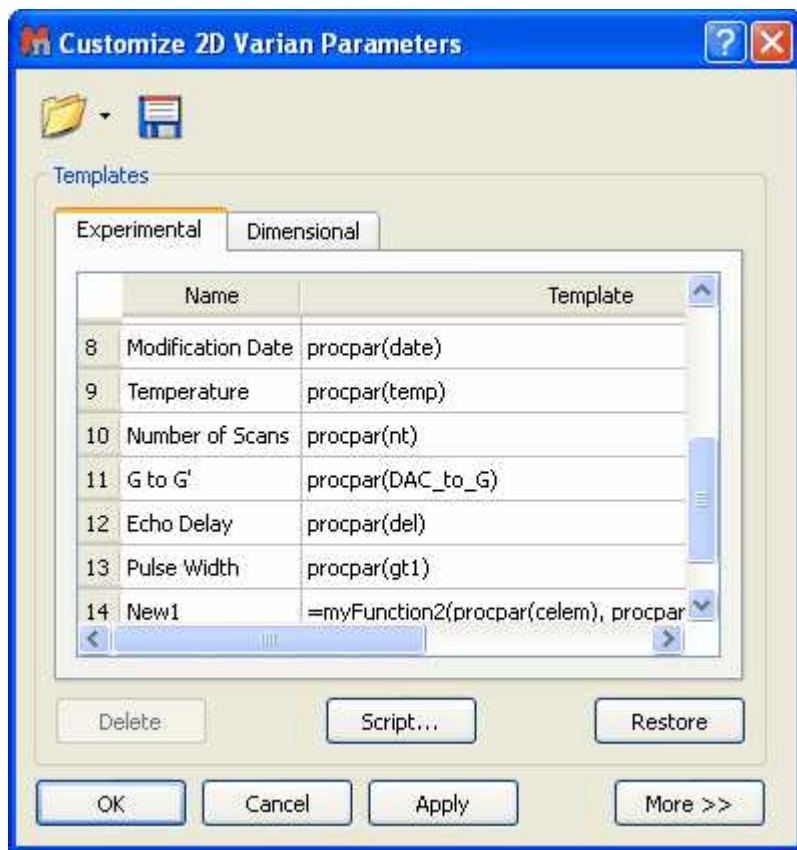

Clicking on the 'More>>' button will display the 'Current Spectrum Parameters' window, as you can see in the picture below. The user will be able to obtain any parameter from any raw data file (procs, acqu, title, etc...) by selecting the desired file on the 'File/Block' box (red square in the picture below):

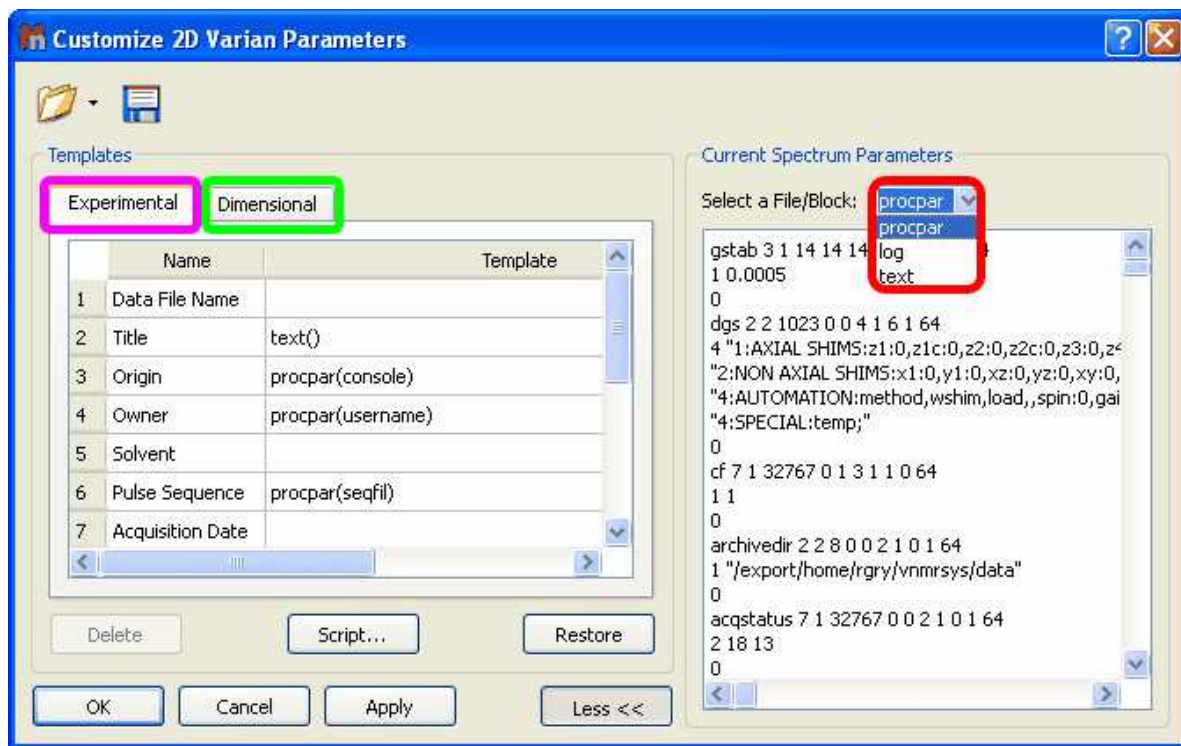

In the 'Customize Parameters' dialog box, the user will see an 'Experimental Parameters Template' (pink square in the picture above) which will be common for 1D and 2D (with information about: Title, Origin, Owner, Solvent, Temperature, etc.) and the 'Dimensional Parameters Template' (green square in the picture above) with information about the 'Spectrometer Frequency', 'Acquired Size', 'Spectral Width', etc.). Both sections have blank rows in their last position to allow for addition of further parameters.

You can easily add any existing parameter from the raw data. Start by selecting the location of the parameter in the Experimental or Dimensional Parameters Template by clicking on the relevant cell of the 'Template' column on the table. Once this has been selected, double click on the desired parameter (from the 'Current Spectrum Parameters' box). This will add the chosen parameter to the template.

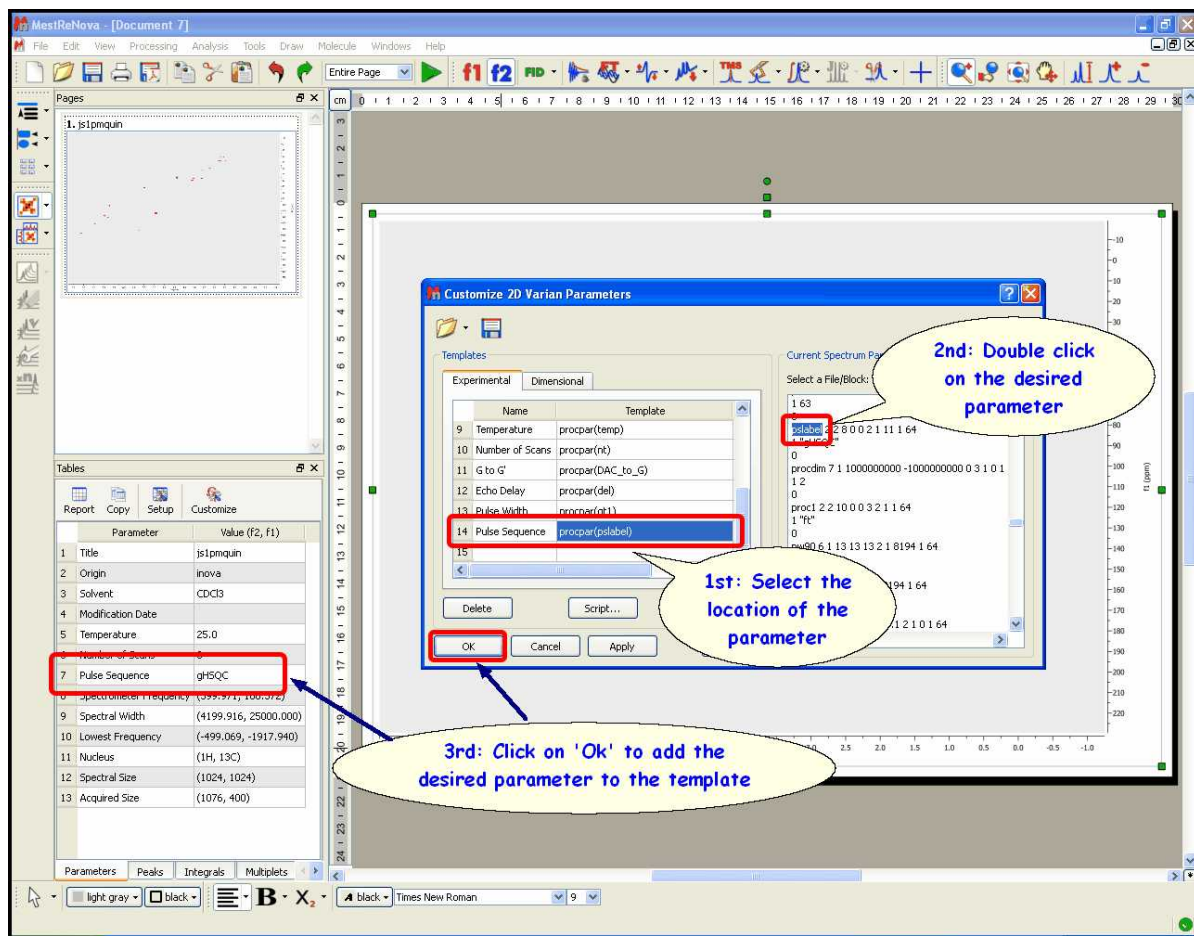

Let's see now **how to add the title from the 'parm.txt' file (Bruker):**

- 1st: Select the location of the parameter in the Experimental Parameter Template.
- 2nd: Select 'parm.txt' in the 'Current Spectrum Parameters' combo box.
- 3rd: Double click on the desired parameter (NAME, in this case).
- 4th: Click on 'OK' to add the parameter to the template.

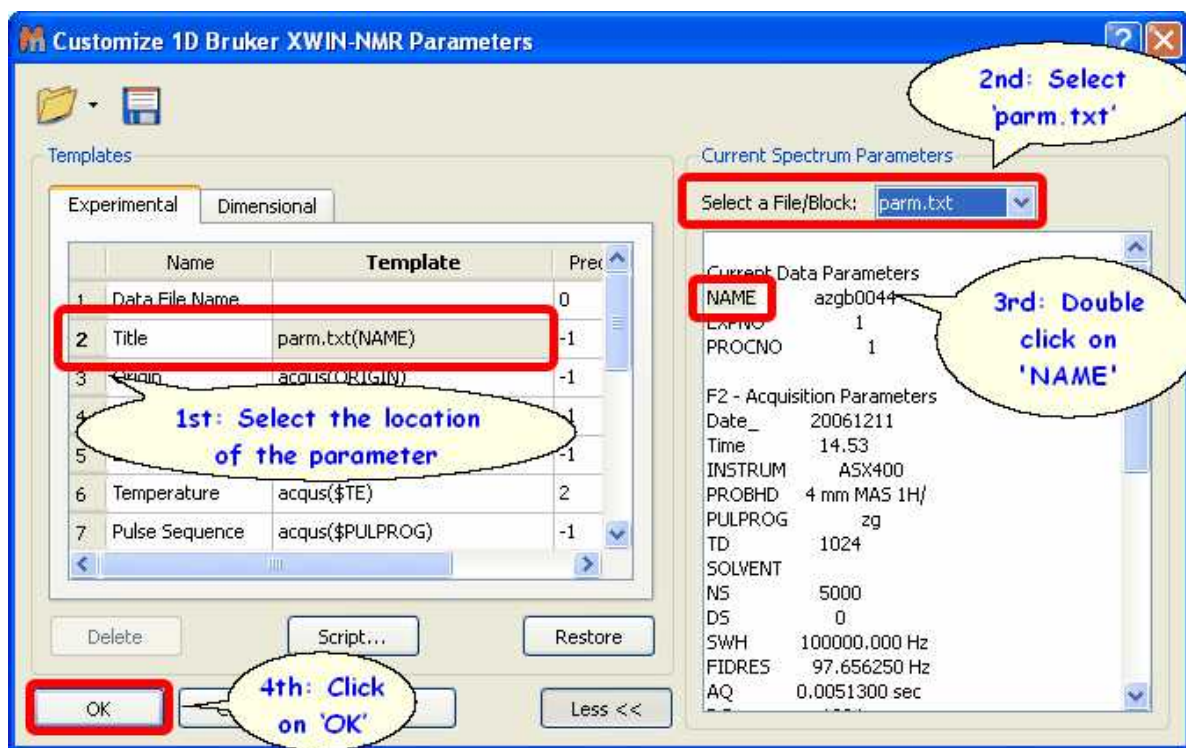

Then, you will obtain the title on the parameters table:

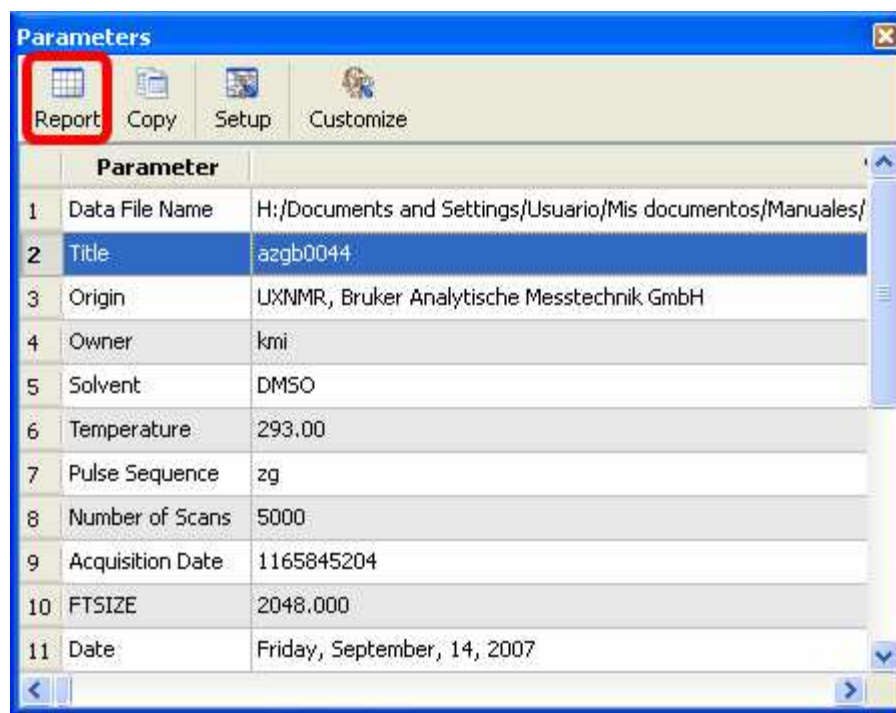

Finally you will be able to add the Parameters Table to the spectrum by just clicking on the 'Report' button (highlighted in red in the picture above).

This is the way to add the 'easy' parameters to the 'Parameters Table'. However, there are other parameters which need a different procedure to be added from the 'parm.txt' file to the table. For example, some parameters with the same name i.g. for 2D can be written two times (for example the Spectral Frequency for f1 and for f2). Also some parameters have units. The syntax of the *parm.txt* file parsing allows handling both situations (allowing either to get a number, or a number with the units, or even only the units).

Please bear in mind that the syntax of the 'parm.txt' parsing is:

parm.txt(PARAMNAME[;OCCURENCE;FIRST_WORD;NUMBER_OF_WORDS])

Let's see how it works with a real example where we want to include the Spectral Frequency value for f1 and f2. As you can see in the picture below there are two values for the parameter 'SF' in the *parm.txt* file (one for f2 and another for f1):

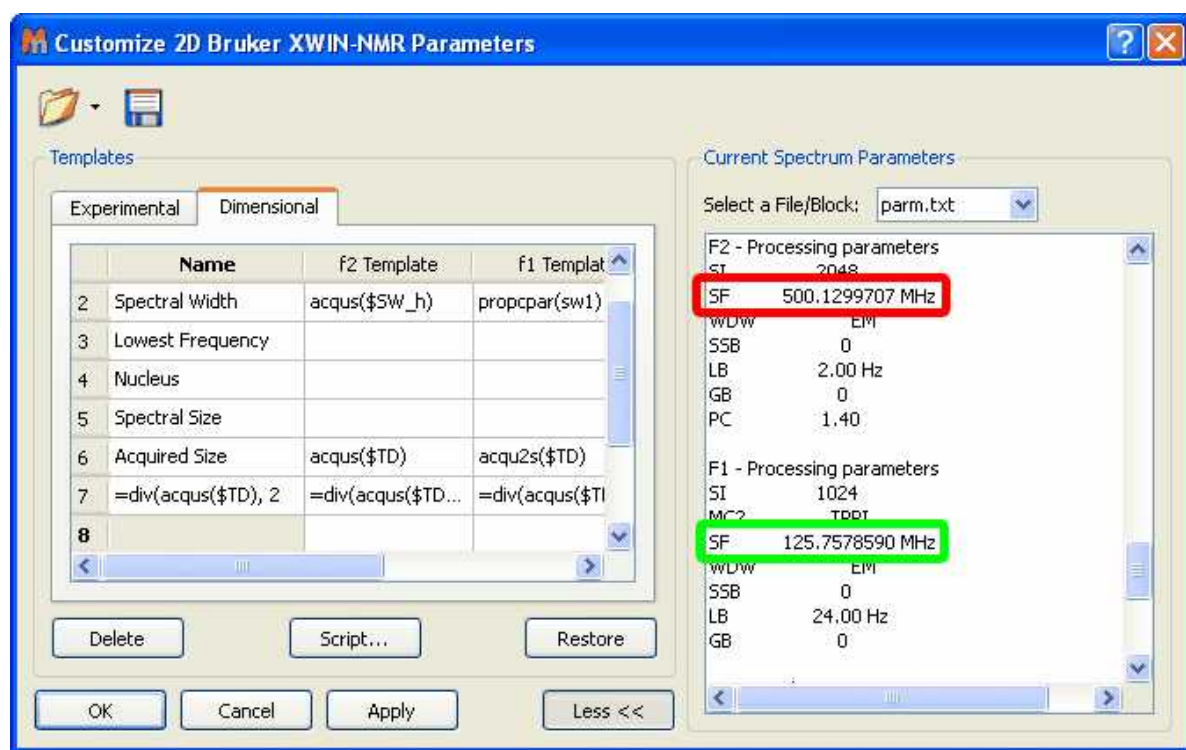

We can not follow the same procedure that we followed a few pages before to insert the title on the parameters table, because now, we have two different parameters (one for f2 and another for f1) with the same name (SF).

For this reason we need to use the syntax of the *parm.txt* parsing, typing in the 'f2 Template' cell: **parm.txt(SF;1;1;1)** where **SF** is the name of the parameter, the first number ('1') indicates the order of appearance (The f2 parameter appears before in the *parm.txt* file than the f1). The second and the third number indicate the first word and the number of words of the string, respectively. In this case, the parameter has two words: the value (500.1299707) and the unit (MHz), but we are not interested in getting the units, so type (SF;1;1;1). If we were interested in also include the units, we must type: (SF;1;1;2).

In the 'f1 Template' cell; we would type: **parm.txt(SF;2;1;1)**, because the SF parameter for f1 appears in the second position (after the SF value for f2):

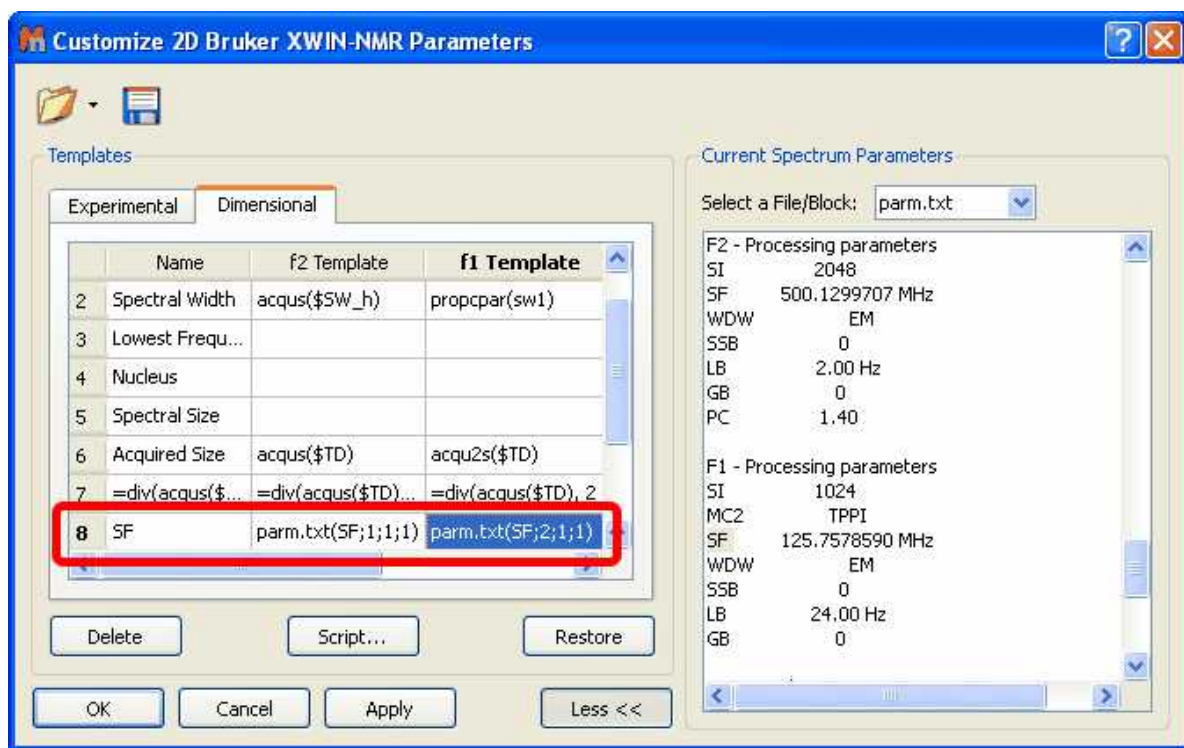

Similar procedure will be followed, for example, to include the LB parameter for f2 and f1, as you can see in the picture below:

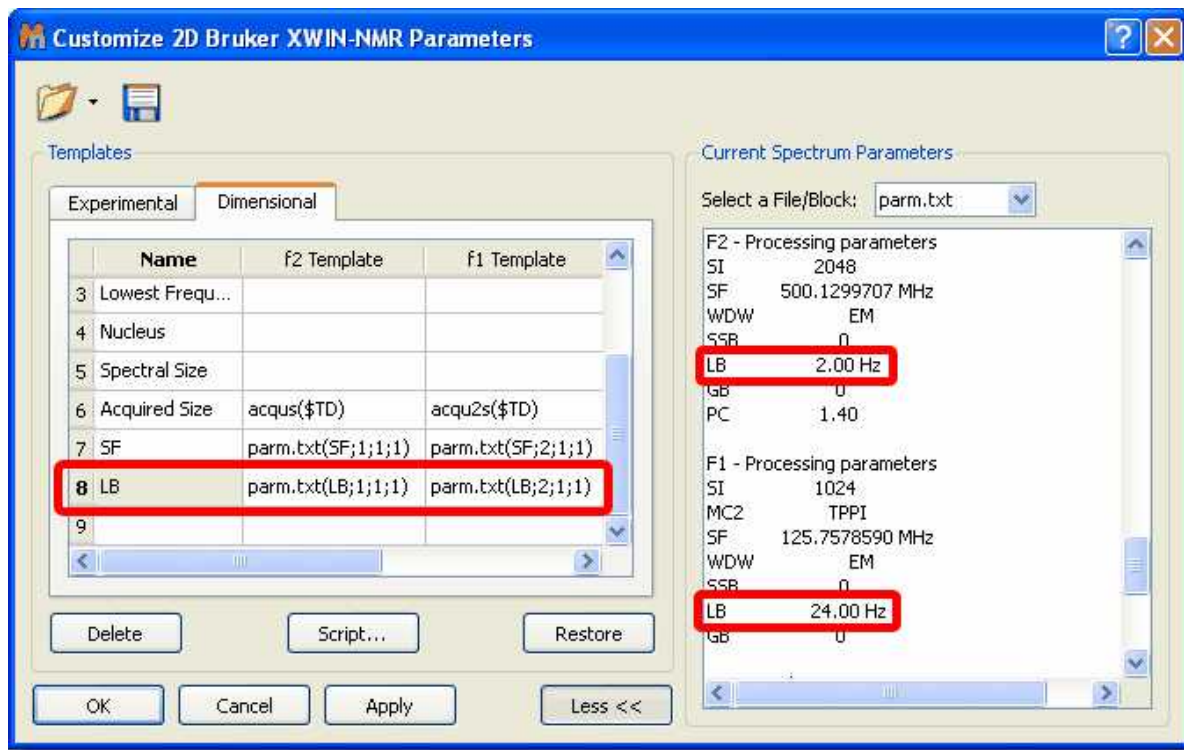

And here it is the result:

	Parameter	Value (f2, f1)
1	Title	lcec671m
2	Origin	UXNMR, Bruker Analytische Messtechnik GmbH
3	Owner	root
4	Pulse Sequence	mm_invigsm1tp
5	Acquisition Date	2002-07-24T22:19:15
6	Temperature	300.0
7	Number of Scans	16
8	Spectral Width	(2500.000, 6289.308)
9	Lowest Frequency	(500.455, 6915.965)
10	Nucleus	(1H, 13C)
11	Spectral Size	(512, 512)
12	Acquired Size	(1024, 256)
13	SF	(500.13, 125.76)
14	LB	(2.00, 24.00)

Imagine, that you have a parameter which appears in the middle of another parameters. For example the 'Mixing Time' parameter of a NOESY spectrum (from Bruker); which appears in the acqu file with this format:

```
##$D= (0..63)
3e-06 0.9643645 0 0 0 0 0 0 0 0.06 0
0.03 2e-05 3e-06 0 0 0.0002 0 0
0.00025
1e-05 1e-05 0 0 0 0 0 0 0 0 0 0 0 0
0 0 0 0 0 0 0 0 0 0 0 0 0 0
0 0 0 0 0 0 0 0 0 0 0 0 0 0
```

You want to display in this case, the D9, so you will need to type **acqu(\$D[9])** in the Parameters template list as it is shown in the picture below:

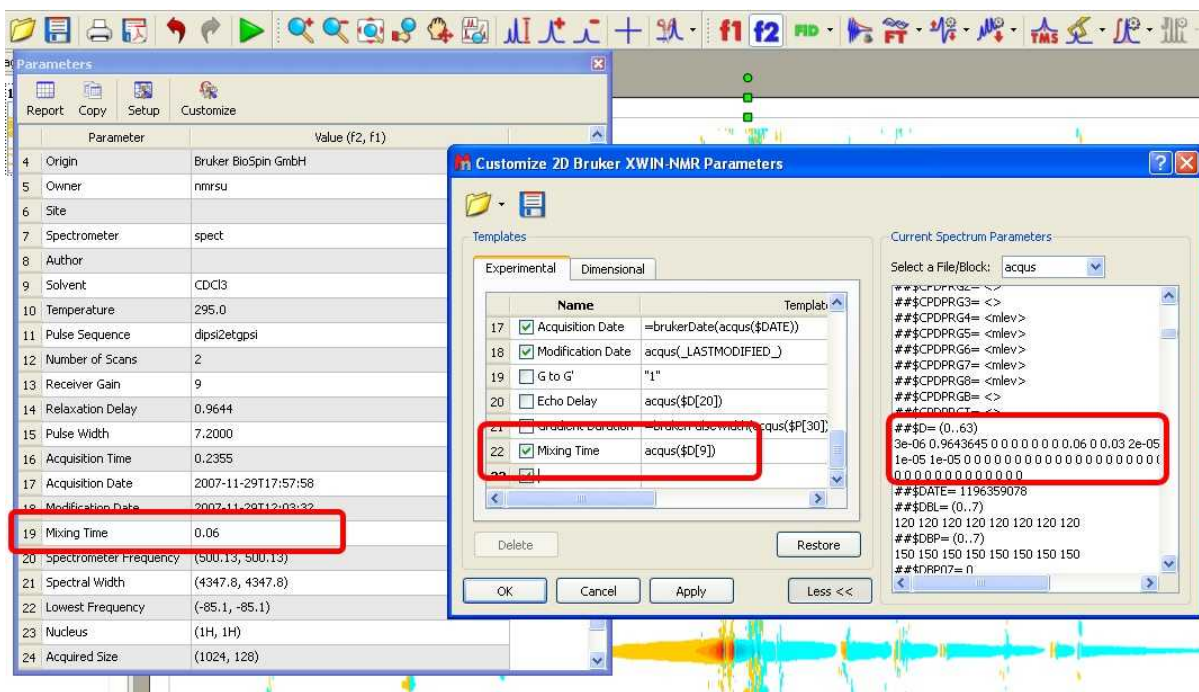

The user will also be able to add his/her own parameters by double clicking on the table and typing the corresponding parameter name (between "quotation marks") and value. In the picture below, we have added manually the text "December, 30th, 2007" in the field: 'Original Name' and 'Date' as the 'Visible Name'

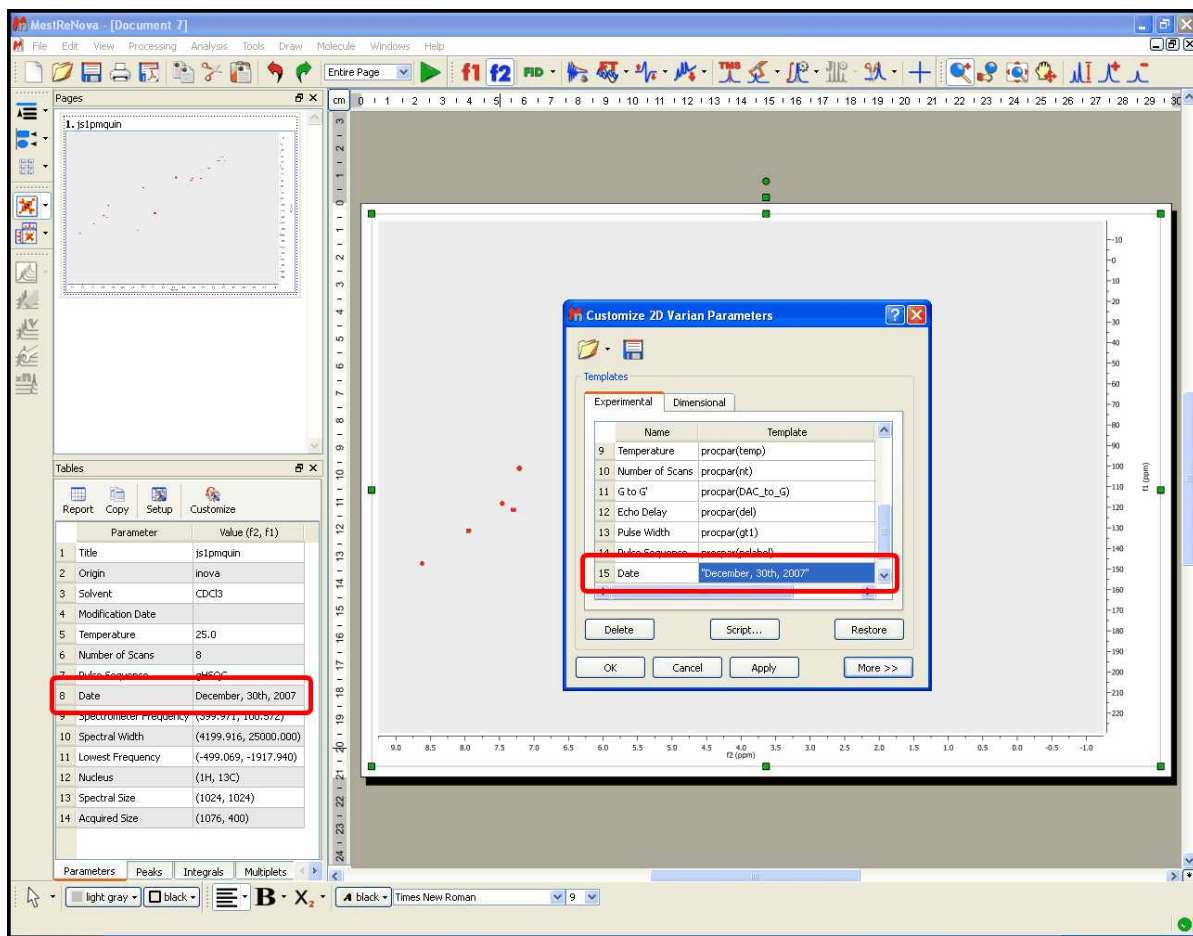

The user will also be able to introduce formulas (available in the script) by typing an *equal* symbol followed by the desired formula (numbers or parameters), for example: `=sum(a, b)`, or `=div(acquis($TD), 2)`. Please note that formulas are case sensitive and should be lower case.

The following example shows the procedure to show the 'Time Delay' in seconds. Firstly, we need to double click on the desired parameter in the 'Current Spectrum Parameters' list to add it to the 'Parameters Template':

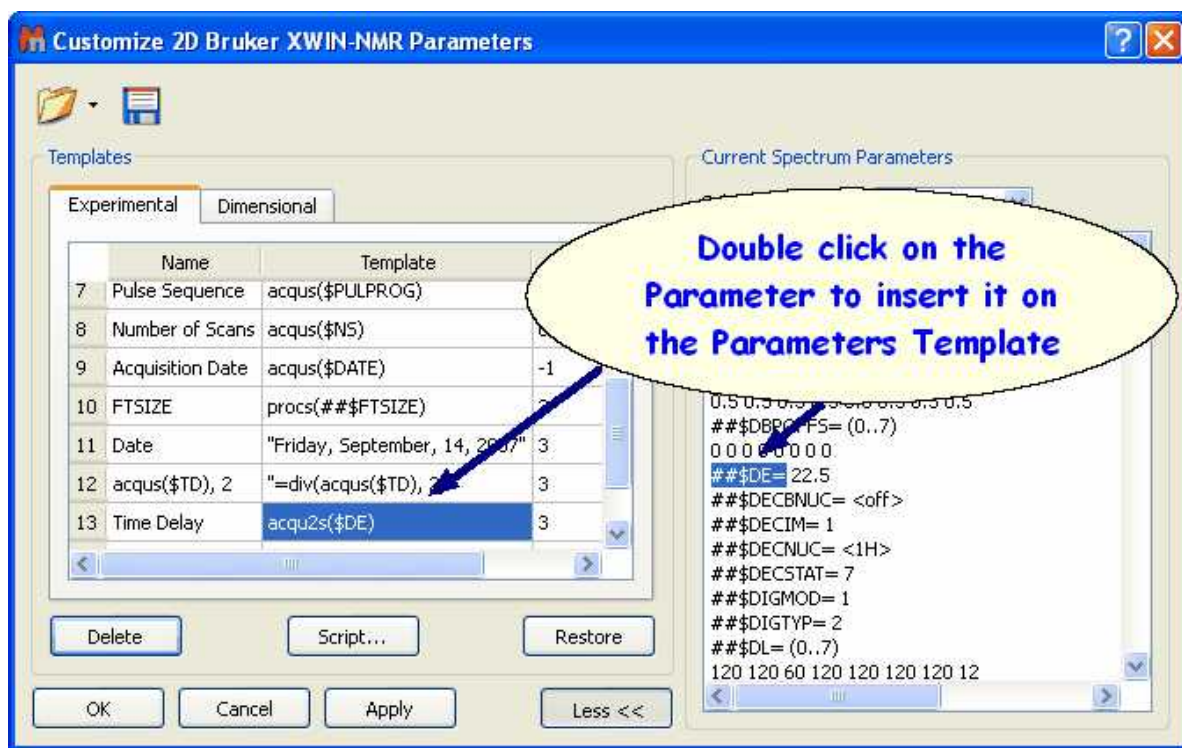

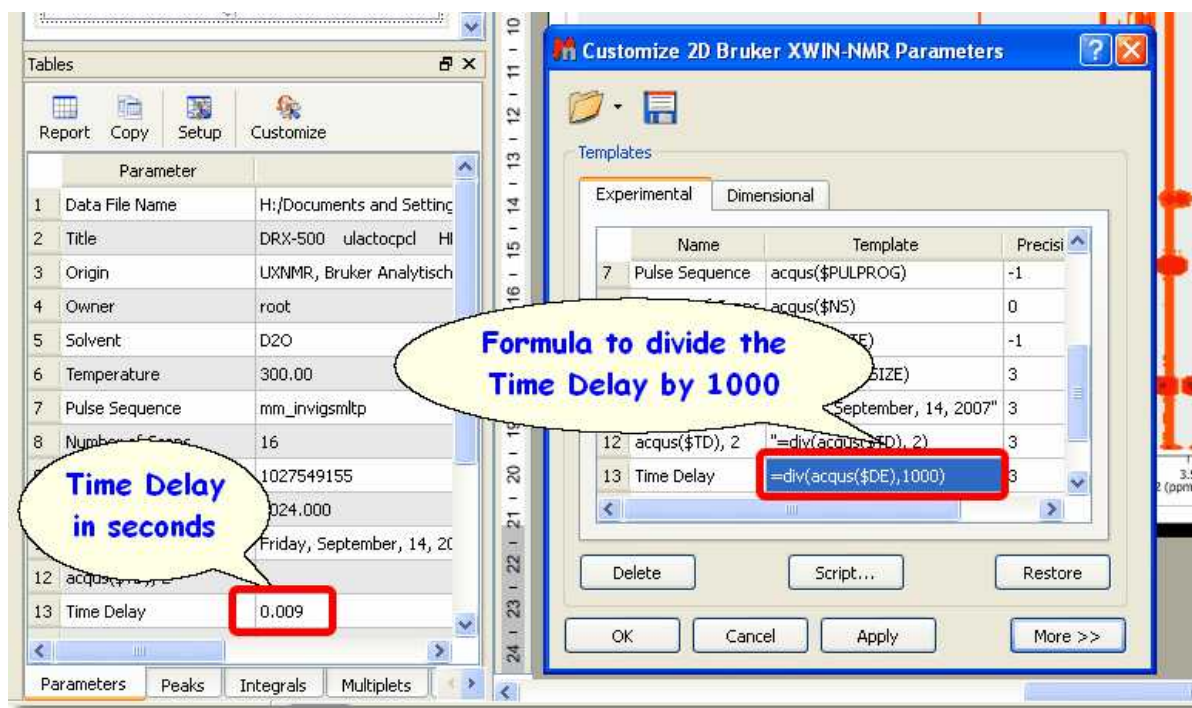

By default the Time Delay is showed in milliseconds, so we need to divide the value by 1000 to obtain it in seconds. So, the user will need to type '=div(acqu(\$DE),1000)' in the 'Parameters Template' to get the division. In this way the user will obtain the 'Time Delay' value in seconds in the Parameters Table, as you can see in the picture below:



The parameters will be hidden in the table display if the user removes the corresponding tick mark on the 'Visible' Column. The user can also delete any parameters from the table by highlighting each of them and clicking on the 'Delete' button.

The 'Restore' button is used to recover the default template. The user will be able to save his/her own template by clicking on the 'Save Template' icon . To load a template, just click on the 'Open

Template' button . Clicking on 'OK' will save the template in the registry and Mnova will remember it for futures uses. The 'Apply' button is used to view the effect of any changes directly on the parameters table without needing to close the 'Customize Parameters' dialog box.

The user will be able to edit the 'Parameters' script by clicking on the 'Script' button . This will display the script with some functions (to sum, divide, convert Celsius to Kelvin or to Fahrenheit, etc.).

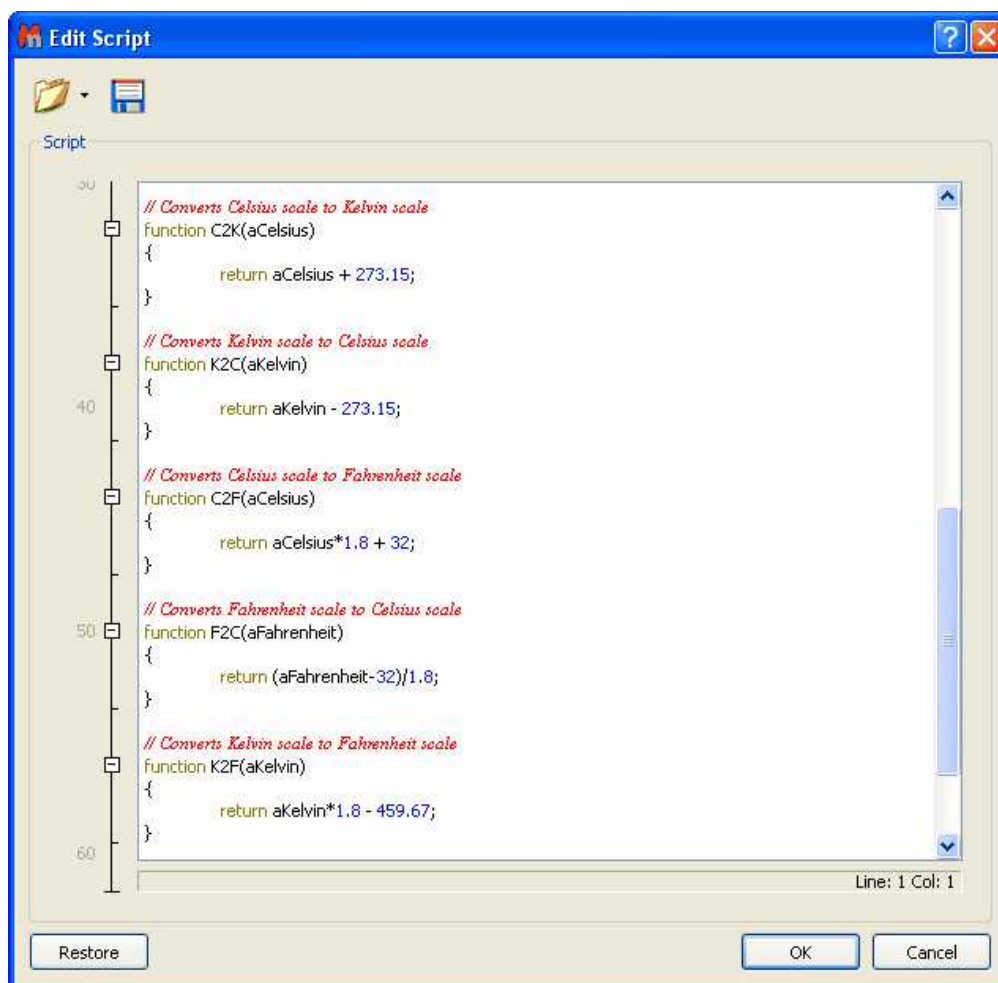

See also:

[Scripts](#)

13.2 Basics on Arrayed-NMR Data Analysis

In this tutorial we shall cover some basic concepts on the analysis of a very important class of NMR experiments, the so-called Arrayed NMR spectra. The concept is very simple: an arrayed experiment is basically a set of individual spectra acquired sequentially and related to each other through the variation of one or more parameters and finally grouped together to constitute a composite experiment. These experiments are also known as 'pseudo-2D'. For example, in the case of Bruker spectra they have the same file name as 2D spectra, that is ser files (ser = serial spectra). In the case of Varian, the file name is fid (Varian uses the same name for 1D, 2D, 3D, ... and arrayed spectra). However, unlike with actual 2D spectra, arrayed spectra are only transformed along the F2 –horizontal or direct-dimension (assuming 1D arrayed spectra only).

The modus operandi is better explained with an example: let's suppose it is necessary to acquire a pulse field gradient (PFG) experiment. Instead of acquiring independent spectra, it is more convenient to create an array with increasing PFG amplitudes. All resulting spectra are now treated as a single experiment. This grouping greatly facilitates processing as, in general, all subspectra require the same processing operations (apart from some occasional minor adjustments of one or several spectra).

Well known examples of NMR arrayed experiments are, among others:

- Relaxation (T1, T2)
- PFG experiments (DOSY)
- Kinetics and reaction monitoring by NMR

Any good NMR processing software should be able to automatically recognize when an NMR spectrum is an arrayed experiment and will setup all processing operations accordingly. For example, the figure below illustrates the results obtained when a Bruker arrayed folder is dragged and dropped into Mnova:

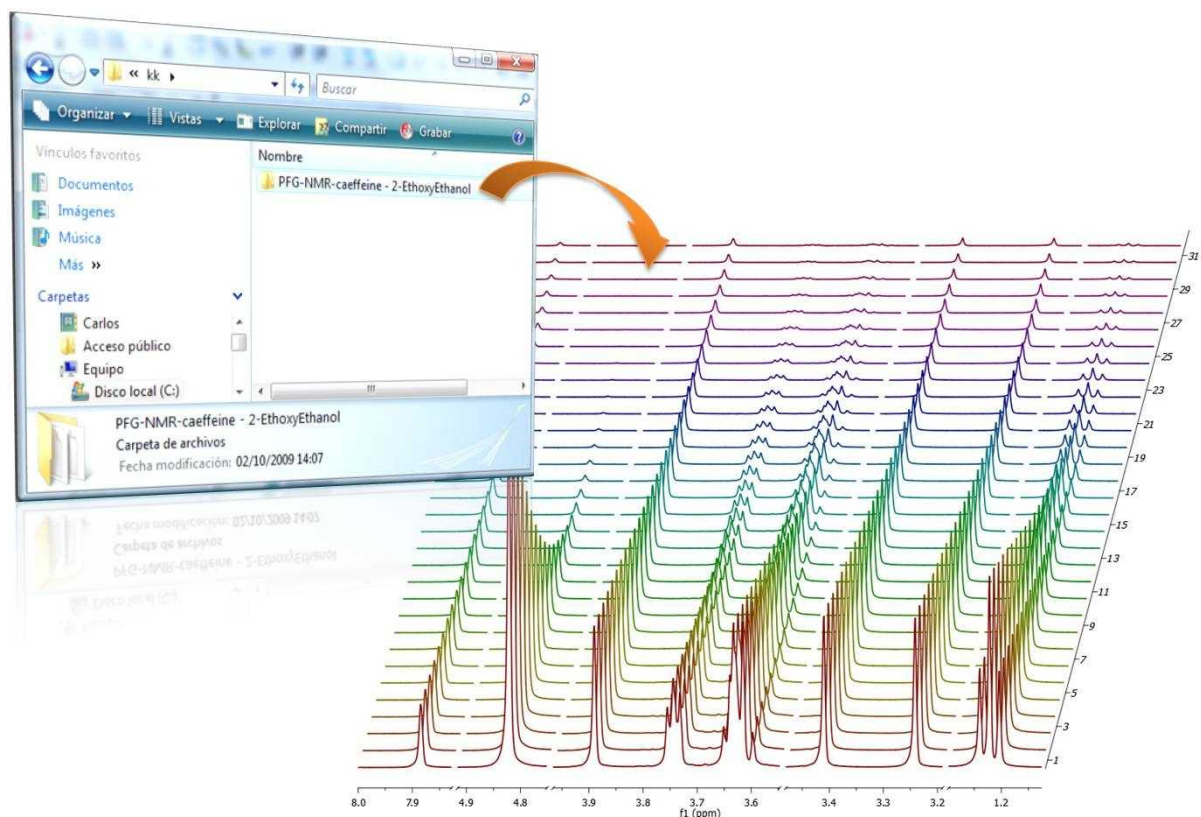

What has happened here are basically 2 things:

1. First, Mnova detects that the dropped folder contains an arrayed experiment
1. With that knowledge in hand, Mnova proceeds to process all the individual spectra, one after the other and of course, along the only valid dimension (F2). So for every spectrum, Mnova applies appropriate weighting, zero filling, FT, phase correction, etc and stacks all the spectra as shown in the picture above

As a result, all individual spectra grouped within one composite item (i.e. arrayed item) have been processed in the same way. However, it's very common that some subspectra might require independent tuning. For example, many PFG NMR experiments present gradient dependent phase shift so that it becomes necessary to adjust the phase of some individual spectra separately. This is very easy to accomplish with Mnova as you will see below.

Practical hints

When an arrayed experiment has been detected, all subspectra are grouped together and plotted in the stacked display mode in Mnova (see figure below).

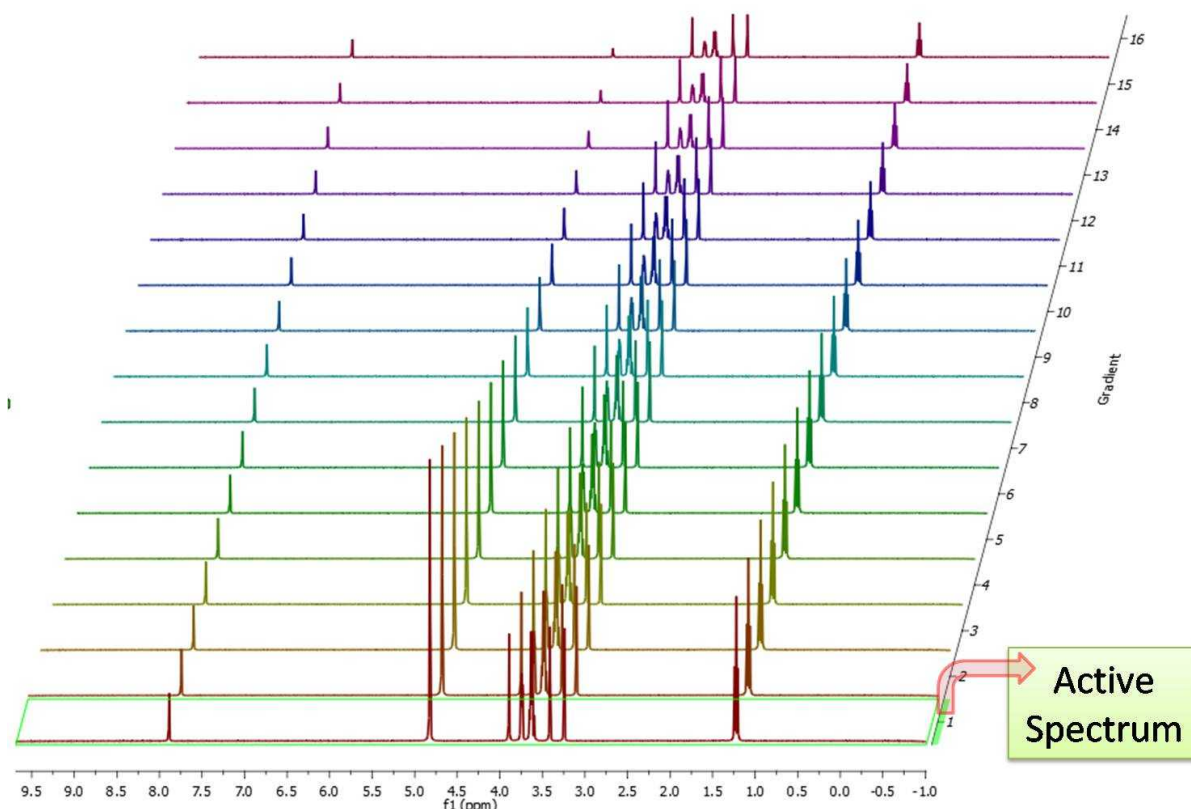

Several points are worth mentioning:

(A). Take a look at the green box in the figure above: it shows the so-called 'active spectrum'. What does this mean?

The concept of active spectrum is easier to illustrate with the following example: as we said before, in general all the spectra in an arrayed item are processed exactly with the same processing operations. For example, same level of zero filling, same apodization function, same FT type, same phase correction, etc. However, it's possible that some particular spectra require a slightly different processing, independently from the others. In order to do that, it is necessary to deactivate the 'Apply Processing to All spectra' in the 'Setup Stack' dialog box by selecting 'Apply to Active'.

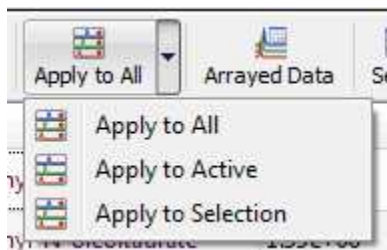

So if the 'Apply to All' option is off, any processing operation will be applied only to the active (or to the selected) spectrum in the stack.

The question is: how can we change the active spectrum? There are 3 different ways:

1. Just click on the spectrum you want to be active. This is probably the most intuitive way.

2. Use SHIFT + Mouse Wheel to navigate throughout all the spectra in the stack, one after the other.
3. Use SHIFT + Up/Down arrow keys. This is analogous to point 2)

(B). If the number of subspectra (traces) is large (e.g. > 10), working in the stack mode might not be very practical. Quite often, working only with the active spectrum on the screen will be a much better option. This mode can be activated as shown in the image below.

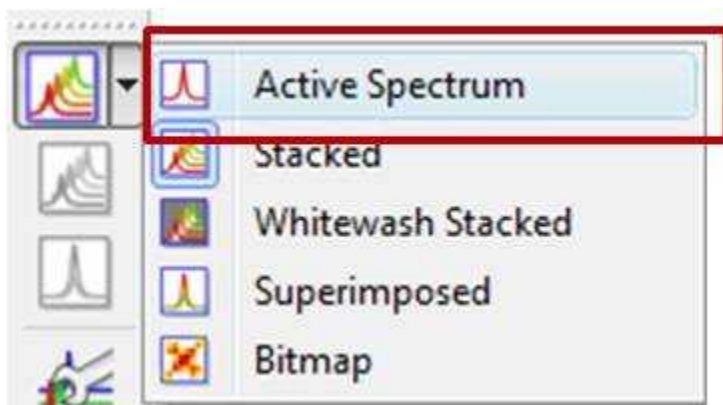

While working on this mode, you will see on the screen just the active spectrum. Should you want to move to another spectrum without resorting to the stack mode, just use methods 2) and 3) described above (Shift+Mouse Wheel or Shift + Up/Down keys).

IMPORTANT: Remember that even if only the active spectrum is visible, unless the “Apply Processing to All spectra in Stack” option is off, all spectra in the stack will also be processed.

(C) Another useful display mode consists of superimposing all subspectra (see figure below). This method is very useful, for example, when you want to check whether some peaks shift their position (for instance, due to differences in pH, temperature, etc., as is common in biofluids spectra).

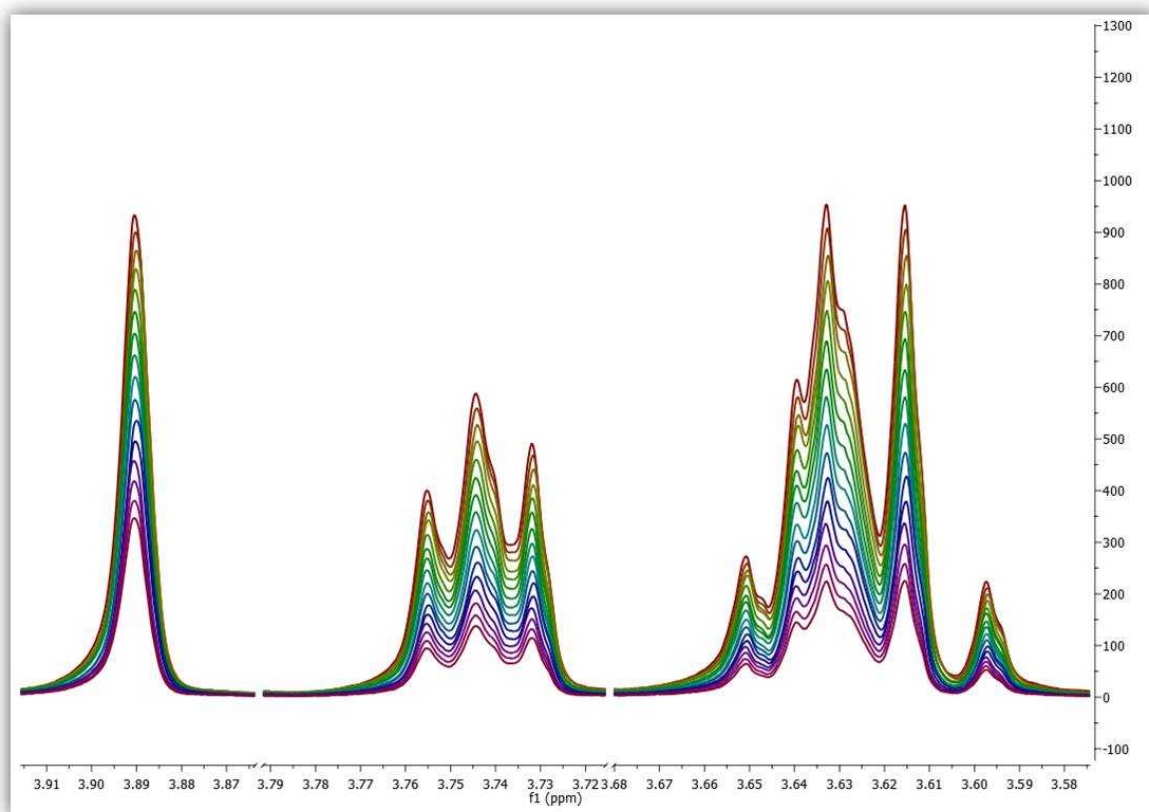

Finally, there is an additional display mode, the so called whitewashed stacked plot. The whitewashing effect means that the spectra at the front of the display hide the spectra behind them from view, as depicted in the figure below.

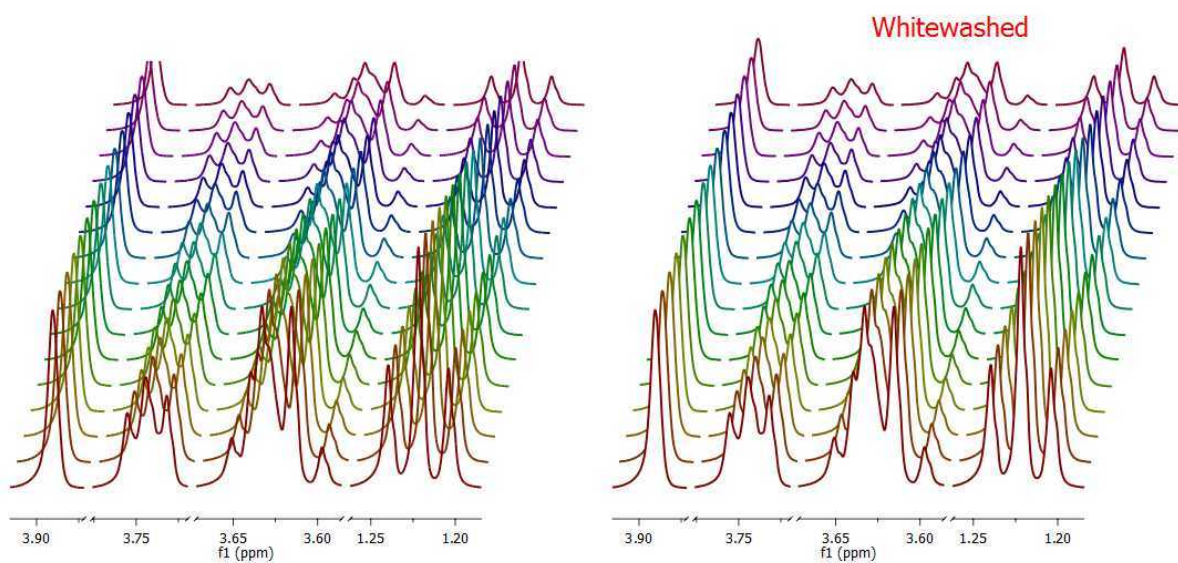

This plotting mode can be useful to create nice reports, but it's important to emphasize that drawing

time will be significantly higher than with the other plotting modes, so it is not recommended when processing the spectra in real time (e.g. interactive phase correction).

Extracting and calculating useful NMR related molecular information

After the basic introductory lines on arrayed NMR experiments, it's now time to get some action and see how to extract relevant information from these experiments and calculate useful NMR related parameters such as diffusion, relaxation times, kinetics constants, etc.

Actually, in this tutorial we will cover the first case, that is, the analysis of PFG experiments to calculate diffusion coefficients.

This is how a PFG (Pulsed Field Gradient) experiment can be analyzed with [Mnova](#) with the Data Analysis module (for your information, Mnova includes a DOSY-like processing algorithm based on a Bayesian Algorithm. For further information about it, please take a look at this tutorial: <http://mestrelab.com/dosy.html> and this post: <http://nmr-analysis.blogspot.com/2008/09/baydosy-whats-under-hood.html>)

You can download the full PFG data set used in this tutorial from [here](#).

Once the arrayed spectra has been loaded into Mnova, issue menu command Advanced/Data Analysis. The so-called Data Analysis widget will popup. This will be the central control panel (see figure below) for anything related to the analysis of arrayed experiments.

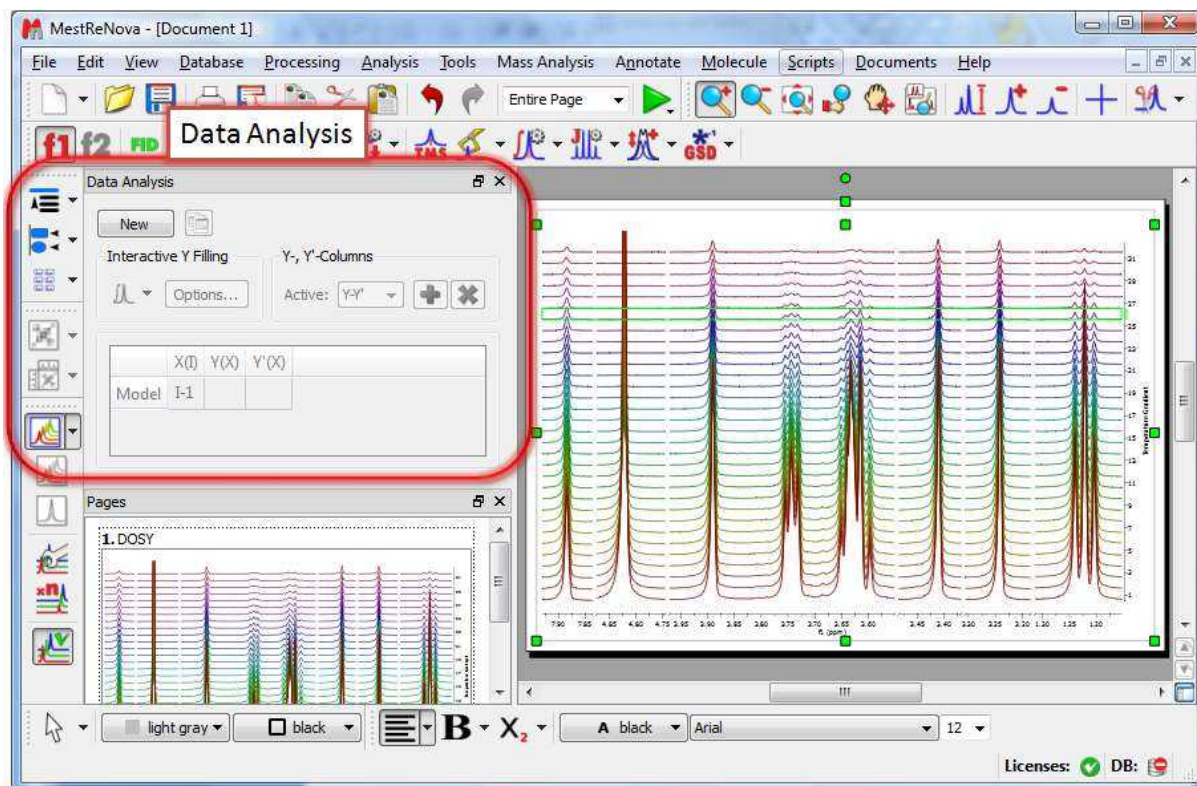

Its operation is very simple. The first thing you have to do is click on the New button. As a result, Mnova will populate the X-Y Table with some initial values (as described below) and create a new item, the so-called Data Analysis Plot. This new item will display the values from the X-Y Table which in general are the values extracted from the arrayed spectra, both experimental (Y) and fitted (Y').

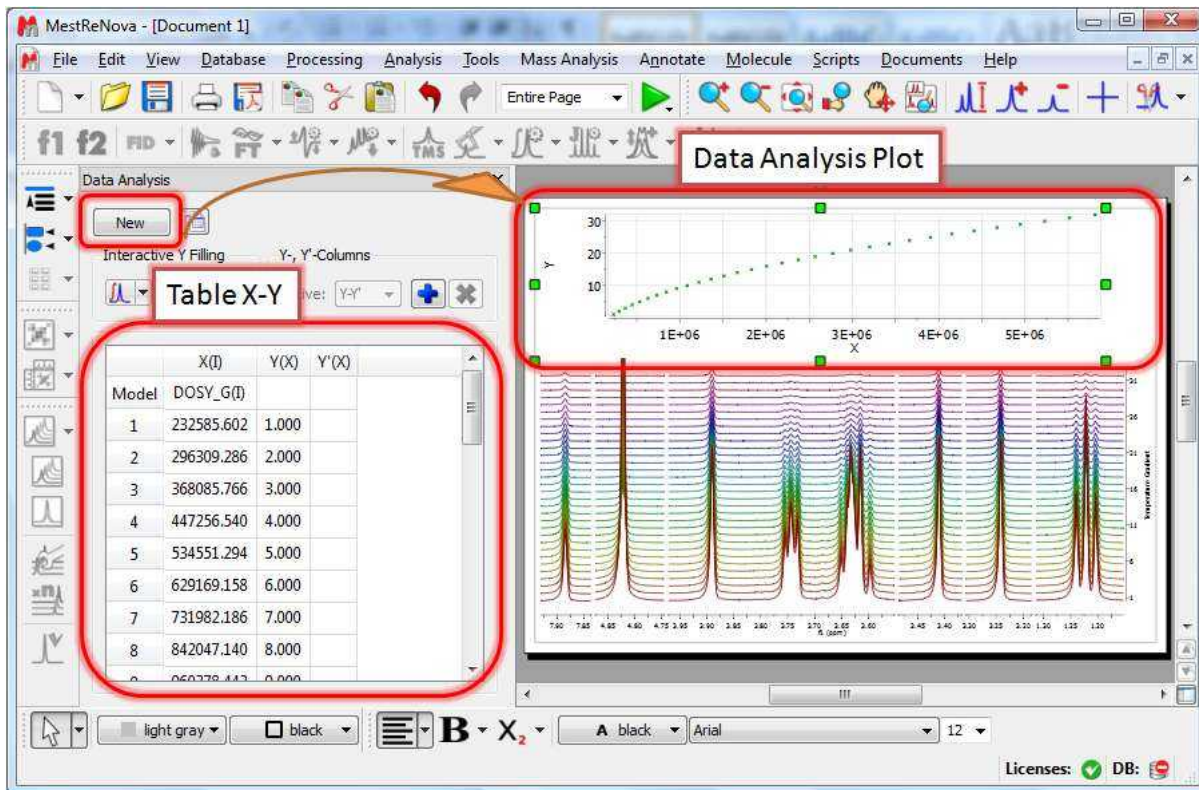

The X-Y Table

This table is composed by one X column, X(I), one or several Y-columns (Y, Y1, Y2, etc) to hold the experimental values extracted from the arrayed spectra and one or several Y'-columns which hold the fitted values of their Y counterpart columns.

X-Column

When the table is initialized, in the case of PFG experiments the X-column is populated with the Z values from the Diffusion table, that is, the gradient strengths scaled by taking into account the constants from the selected Tanner-Stejskal model. In the case of a relaxation experiment, the X column will contain the time delays. Of course, it is possible to change the contents of the X-column by following any of these methods:

- Manual editing of the individual cells

	X(I)	Y(X)	Y'(X)
Model	DOSY_G(I)		
1	232585.602	1.000	
2	296309.286	2.000	
3	368085.766	3.000	
4	447256.540	4.000	

- Copy & paste from a text file. For example, you can put the values for the X-column into a text (ASCII) file and then paste its contents into the table. To do that, just right click on the first cell you want the paste action to start from.

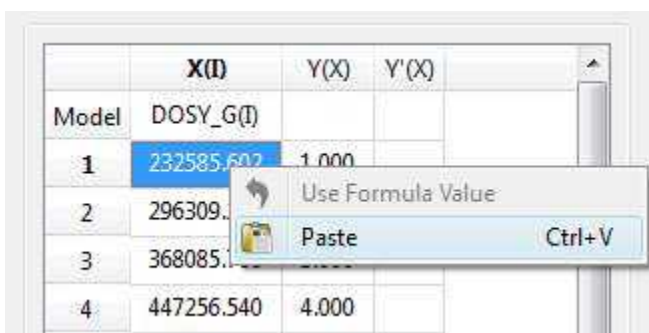

- Enter a formula into the Model cell. Double click on the X(I) model cell (1) and then enter the appropriate equation to populate the X column (2). For example, if you simply enter I, the X column will be filled in with numbers 1, 2,3, etc. If you enter a formula like 10+25*I, the X column will be filled with numbers 35,60, 85, etc.

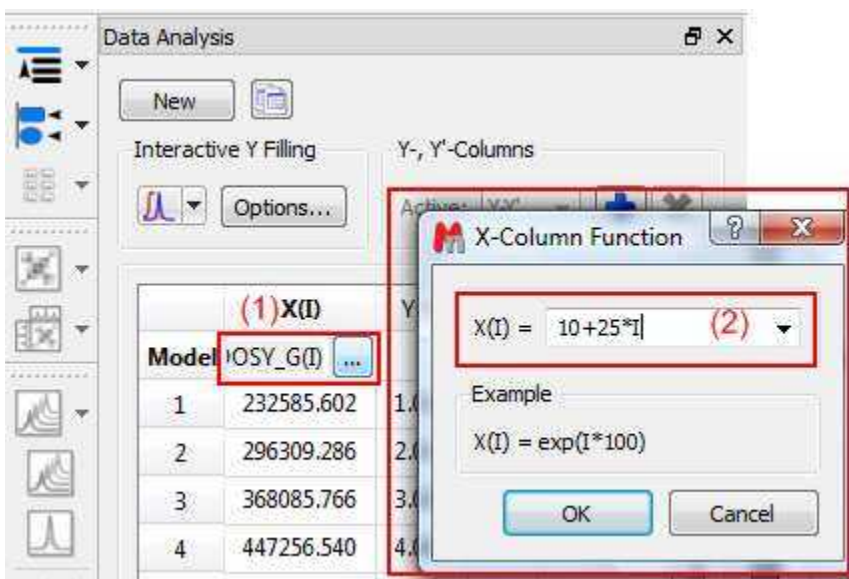

Y-Column

In all cases, when the table is initialized, the Y-column is automatically filled in with values 1,2,3, etc. The purpose of this column is to hold the experimental values from the arrayed experiment. For example, in the case of a PFG experiment, it may contain how the intensity (or integral) of a given peak (or set of peaks) evolves as the applied pulse field gradient changes. Likewise, in the case of T1/T2 experiments, this column will show the relaxation profile of a given resonance (or set of resonances). So the question is: **how to populate the Y-column with actual information from the spectra?**

This is again very easy. There is a graphical way (mouse driven) and a manual one. Let's start with the graphical method:

- Graphical Selection:** Click on the 'Interactive Y Filling' button (see red-highlighted button in the image below). After doing this, the cursor will change into an integral shaped cursor expecting you to select the region from where you want the integrals to be extracted across all the subspectra in the arrayed item. After the selection is done (see figure below), all the integrals will be placed in the Y column and those values will be displayed in the X-Y plot as green crosses (note: the shape, color, etc of these crosses can be customized from the X-Y plot properties).

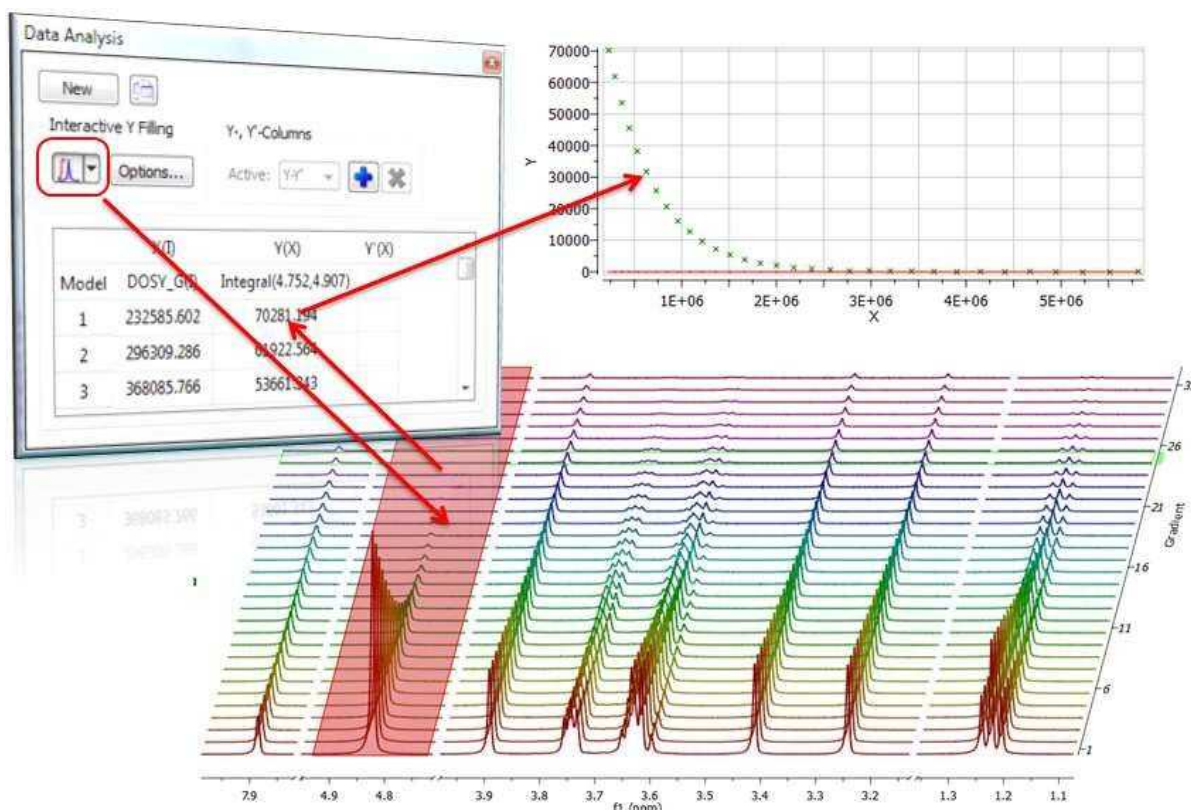

- Manual selection:** if you take a closer look at the Data Analysis table in the figure above, you can appreciate that once the integral region has been selected, the program shows the following text: Integral(4.752, 4.907). This means that we have selected an integral covering that range. This value can be edited manually so that you can specify the limits by simply editing that cell.

Y'-Column

The Y' column is reserved for the fitted values assuming a particular theoretical model (e.g. a exponential decay). In this particular case, as we are dealing with PFG experiments, we will be interested in the calculation of the Diffusion coefficients and thus, our fitting model could be a mono-exponential decay (multi-exponential decays can also be handled with this module, but I will not address this problem in this post). The process is very simple:

First click on the $Y'(X)$ cell and then on the small button with 3 points as indicated in the figure below:

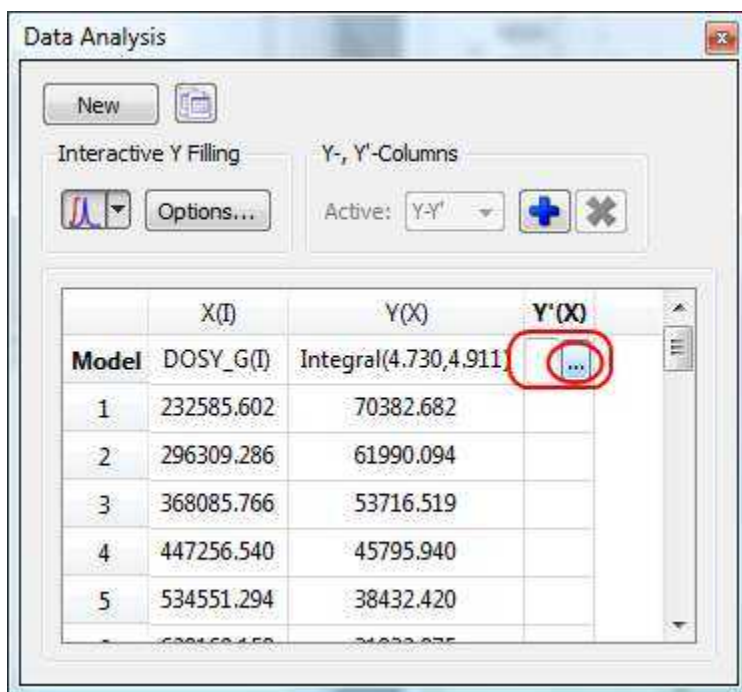

This will launch a dialog box with powerful fitting capabilities.

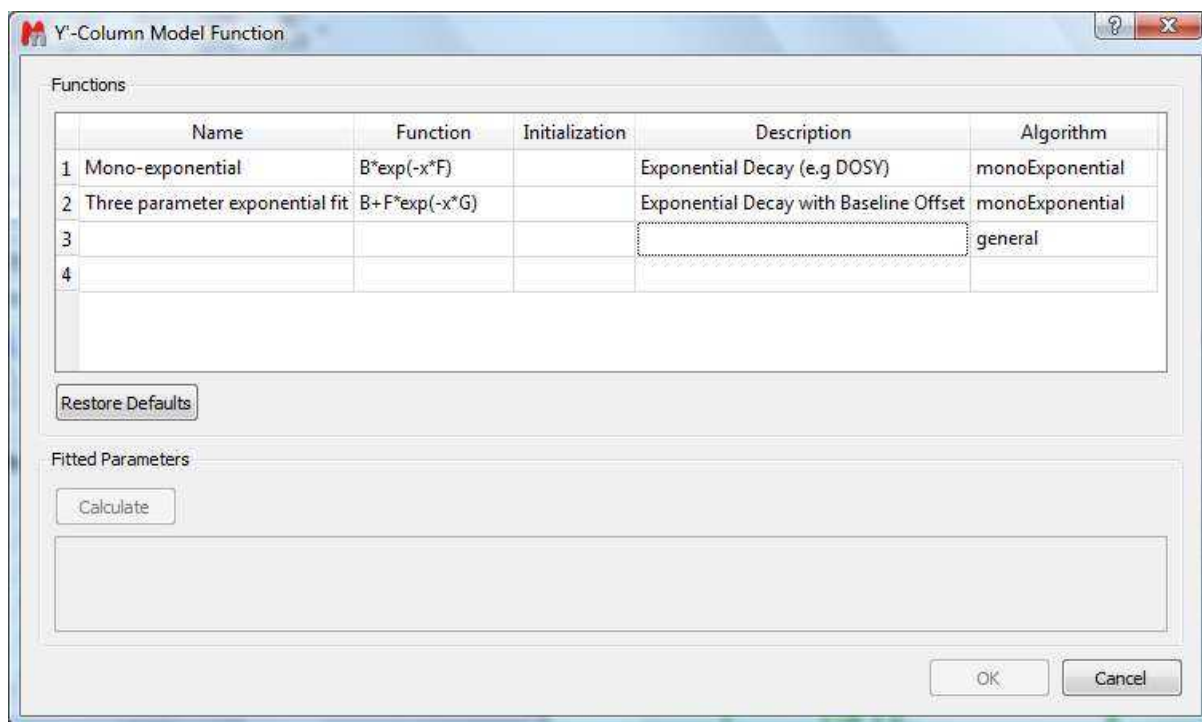

This dialog provides two predefined functions useful for fitting mono-exponential data (such as PFG and Relaxation NMR experiments) using either a 2- or a 3-parameter fit. Furthermore, this dialog offers the possibility to enter user customized functions.

For the time being, suffice to say that if your problem regards mono-exponential functions, just select any of the 2 predefined functions in the dialog box and click on the Calculate button. Mnova will immediately compute the optimal values, returning these optimal values as well as the fitting error and the probability that the acquired series follows the chosen monoexponential model.

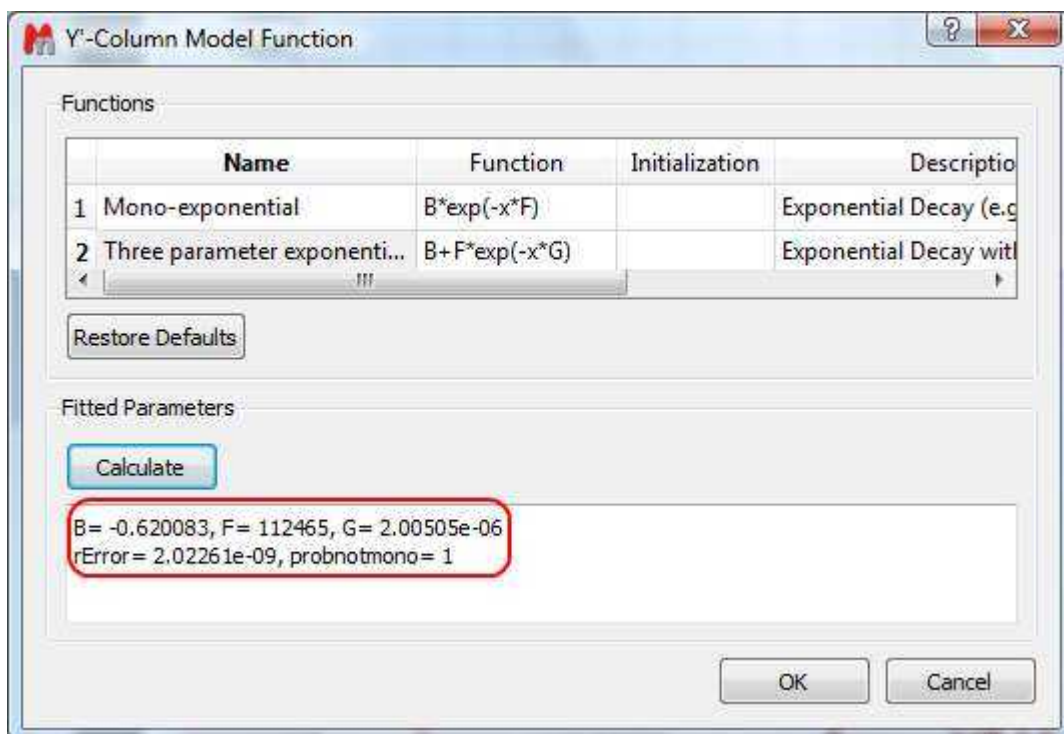

Finally, after closing the dialog, it will populate the Y' column and the X-Y will be updated with the fitted curve (Red line in the figure below).

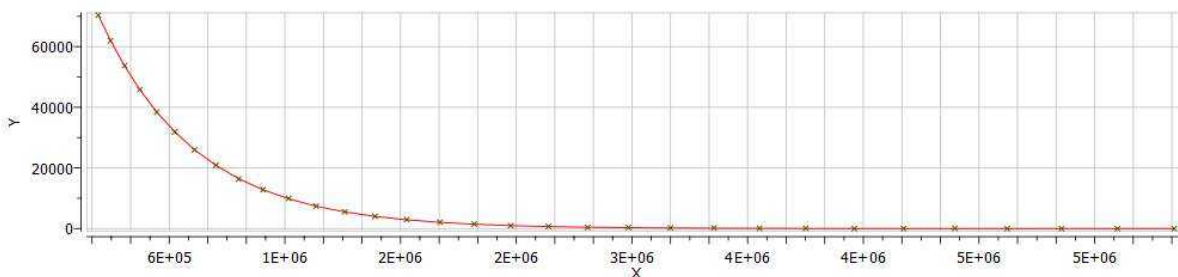

One nice feature of the Data Analysis module is its ability to handle multiple series. For example, it's possible to analyze the decay of several resonances within the same experiment. In order to do that, just click on the (+) button to add a new series and repeat the same process to select the desired resonance range and fit the values. For example, in the figure below I'm showing two curves with different decay rates.

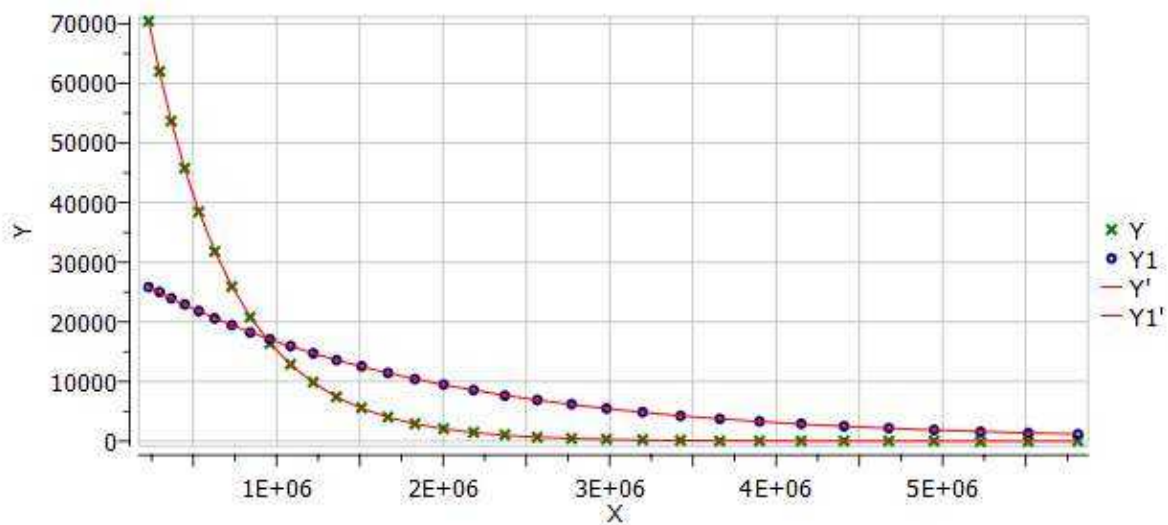

Of the different existing methods for the extraction of peak intensities from arrayed NMR spectra, Mnova provides the following ones:

(1) Peak area integration

This is the default method in Mnova Data Analysis module (see figure below)

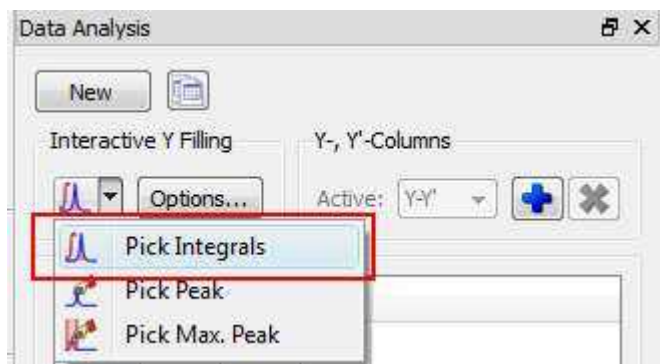

This method consists of a standard numeric integration over the whole peak. Basically, the program is summing up all the points within the selected area of interest) as illustrated in the figure below:

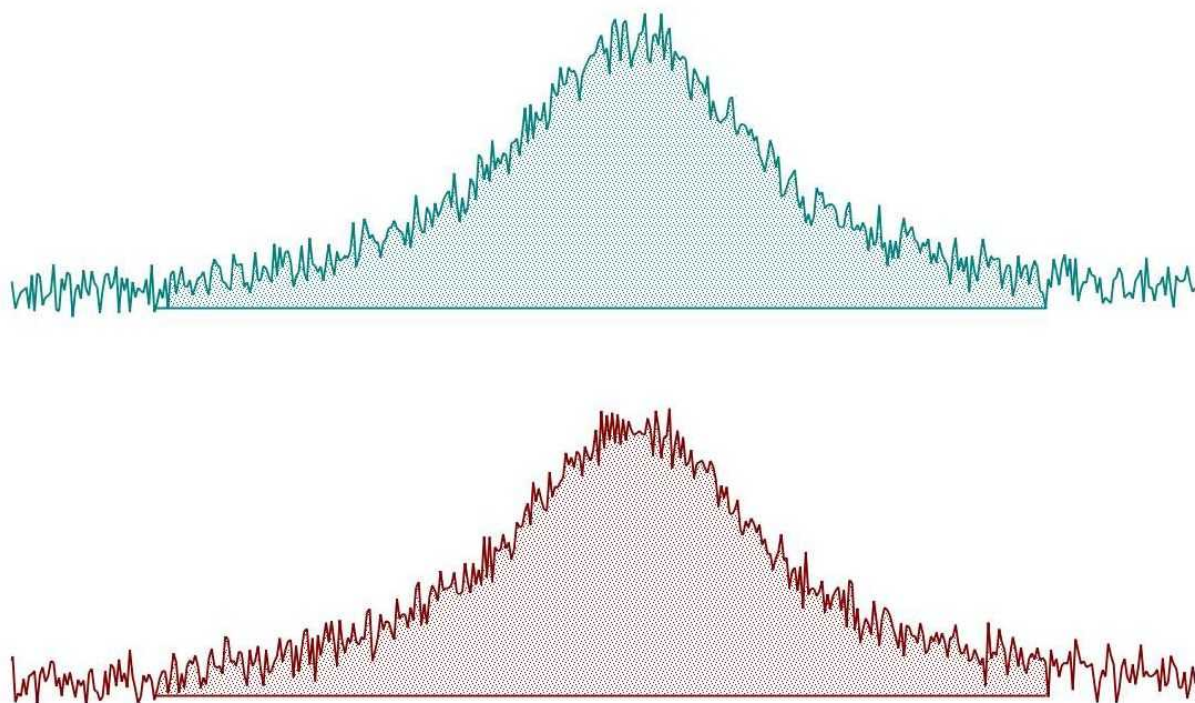

This figure has been created as follow: two identical Lorentzian lines (green & red) were simulated and then noise was added. The noise level is the same in both spectra but obviously, the actual numbers are different (more technically, noise in both spectra was calculated using a different seed in the random number generator).

This peak area method for data extraction is quite robust to noise (provided that the noise level is more or less constant across the different spectra in the arrayed experiment) and more importantly, insensitive to chemical shift fluctuations from trace to trace in the experiment, a situation which is more frequent than generally realized. For these reasons, and for its simplicity of use, this is method of choice for well-resolved peaks.

If the peaks of interest exhibit some degree of overlap, this method is not very reliable and some of the next methods will be more convenient

(2) Peak Height Measurement

This is the second method for data extraction (see figure below) and it finds the peak height at a given chemical shift across all the spectra in the arrayed experiment.

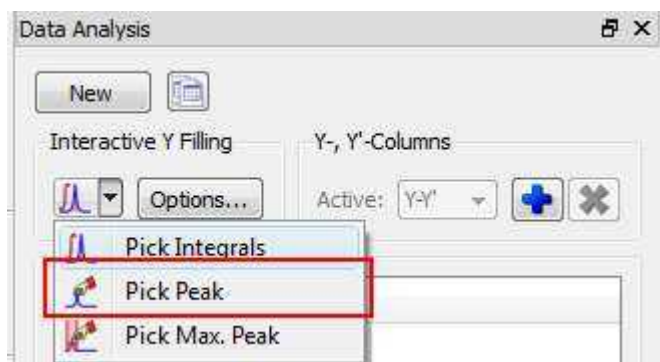

By default, the program will find the peak intensity at the position indicated by the user (using a vertical cursor) and then it will perform a parabolic interpolation in order to refine the value. In addition, the user can specify an interval in such a way that the program will find the maximum peak within that region. This can be done in 2 different ways:

- i) If you click in the Options button, you can define whether you want to use Parabolic and the interval in which the maximum should be found (in ppm



- (ii) Alternatively, once a peak has been selected, you can change the interval by direct editing of the peak selection model. In the figure below, you can see how the peak selection model is PeakIntensity. The first number (6.001 in the figure) corresponds to the central chemical shift whereas the second number (0.100 in the figure) represents the interval for the peak maximum search.

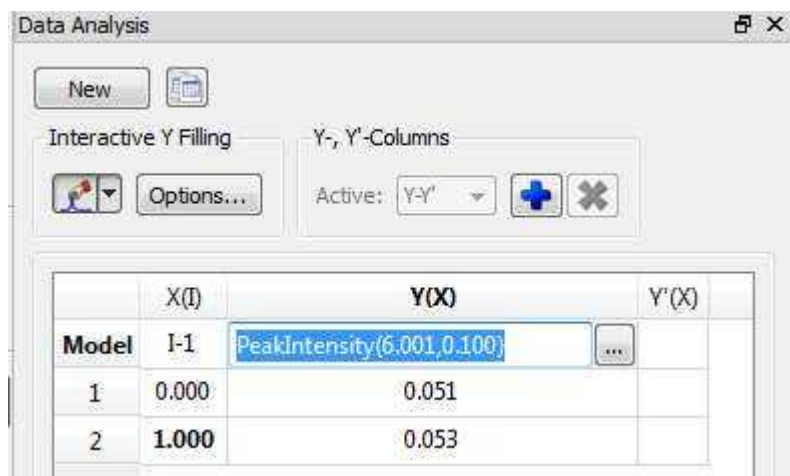

Parabolic interpolation is useful because it minimizes the problems caused by the random noise. For example, let's assume that Parabolic interpolation is not used so that peak heights extraction will be done always at the same fixed chemical shift position (see figure below). When this method is used the values are seen to be quite different in the two cases: here the precision of the measurement will depend strongly on the noise.

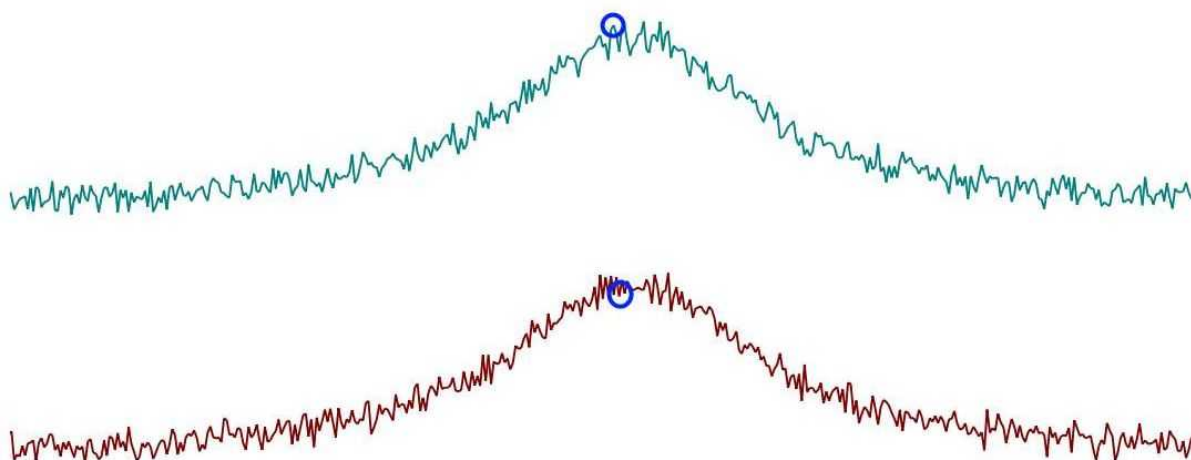

Parabolic interpolation and/or measurement of the intensity as the maximum height within a fixed box around the peak will help to minimize the effects of movements on the chemical shift position of the peaks due to, for example, temperature instability, pH changes, etc.

For convenience, Mnova includes the so-called Pick Max. Peak method which is totally equivalent to the previous one but it allows the graphical selection of the left and right boundaries in which the maximum peak will be searched for.

In a nutshell, peak height measurement can be used in those cases in which peak overlap might represent a problem. However, it should be noted that if for some reasons the line widths of the peaks under analysis change from trace to trace, peak heights will not represent a reliable measurement and peak integrals should be used instead.

In general, we would recommend peak integrals as the most general-purpose method for quantitation of peak intensities in arrayed experiments.

Binning and NMR Data Analysis

It is well known that many NMR arrayed experiments suffer from unwanted chemical shift variations due to fluctuations in experimental conditions such as sample temperature, pH, ionic strength, etc. This phenomenon is very common in NMR spectra of e.g. biofluids (metabonomics/metabolomics) but also exists in many other experiments such as Relaxation, Kinetics and PFG NMR spectra (diffusion).

This problem negatively affects the reliability of quantitation using, for instance, peak heights, and for this reason integration is, in general, a more robust procedure as these spectral variations are mitigated by averaging data points over the integral segment. We will try to show you one simple trick which helps to understand, in a pictorial way, why integration is useful to remove the major part of chemical shift scattering.

First, consider the following experiment depicted in the figure below. It shows a triplet and as you can see, some minor peaks shifts are present from spectrum to spectrum:

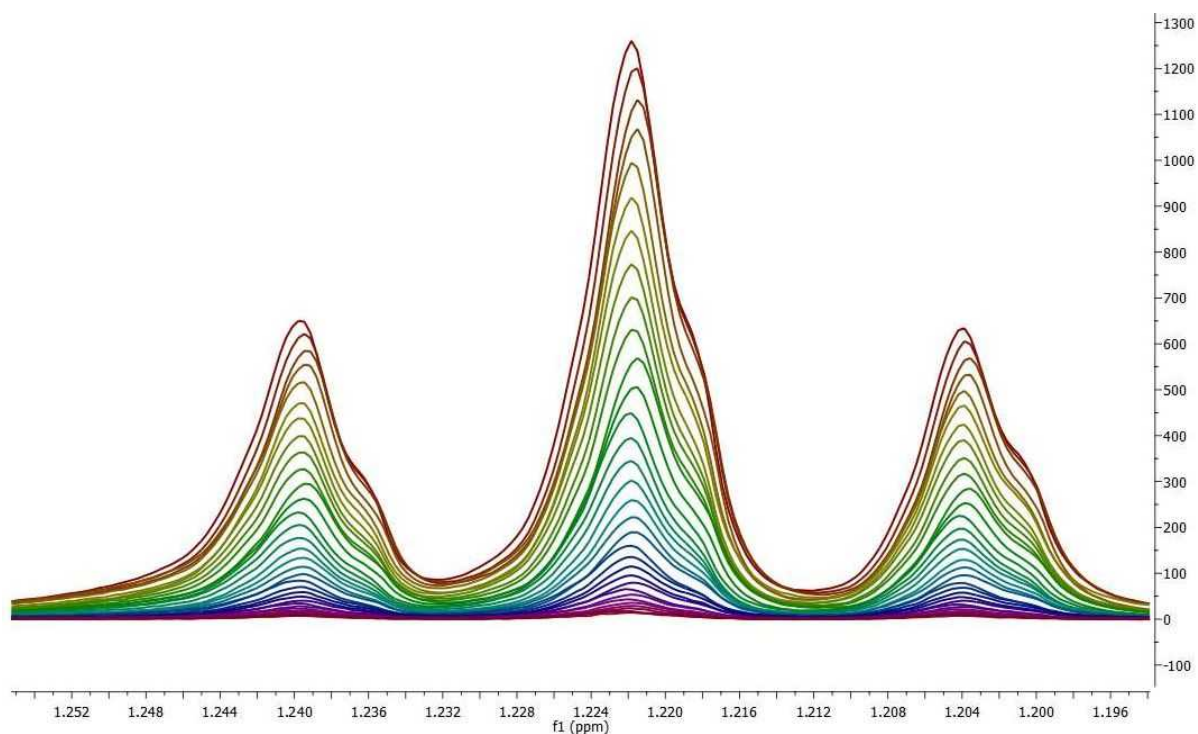

If peak heights are determined at a fixed position, this might introduce appreciable errors in the posteriori quantitative analysis (e.g. exponential fitting). As described before, this could be circumvented in some extent by using parabolic interpolation or peak searching of the maximum in a predefined box.

Nevertheless, integration is a very simple solution as can be appreciated in the figure below. Instead of using the Peak Integrals tool in the Data Analysis module, we will show now a complementary procedure. Basically, what we have applied to all spectra is the well-known [binning](#) operation which consists of dividing each spectrum in equally sized (e.g. 0.01 ppm in this case) bins, so that integral (area) of each bin represents a new point in the binned spectrum.

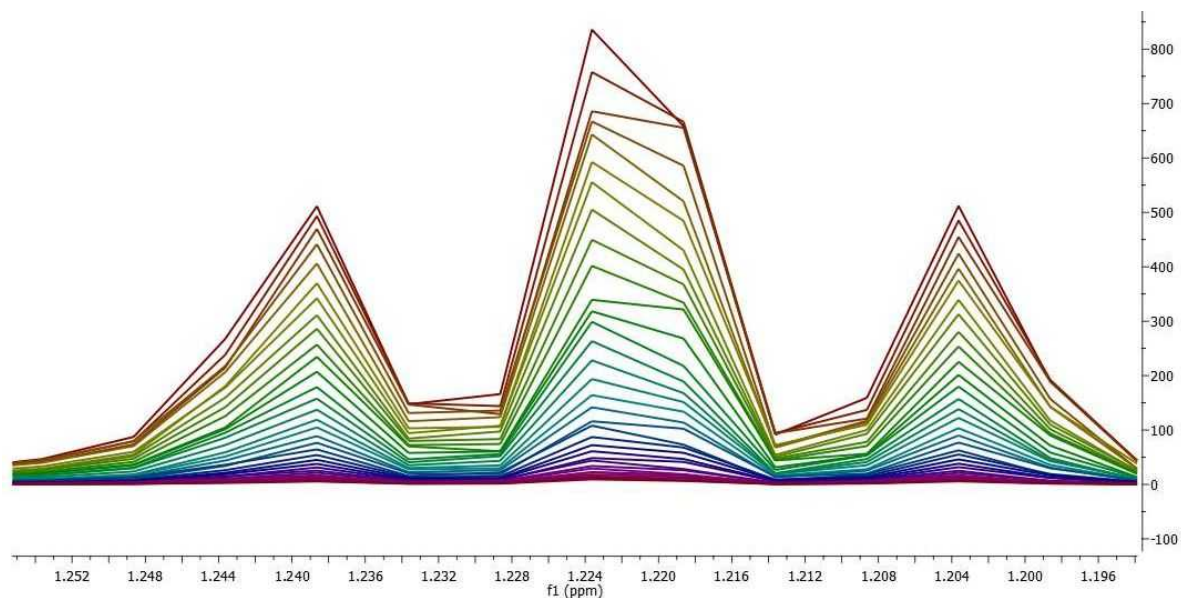

As seen in the figure above, binning clearly removes the effect of chemical shift changes but of course, at the cost of a significant reduction in data resolution.

13.3 Superimposed Spectra

It is very easy to **Superimpose Spectra** with Mnova. Just select the desired spectra on the page navigator (by holding down 'CTRL key' while clicking on each spectrum) and then issue the command 'Stack/Superimpose spectra'.

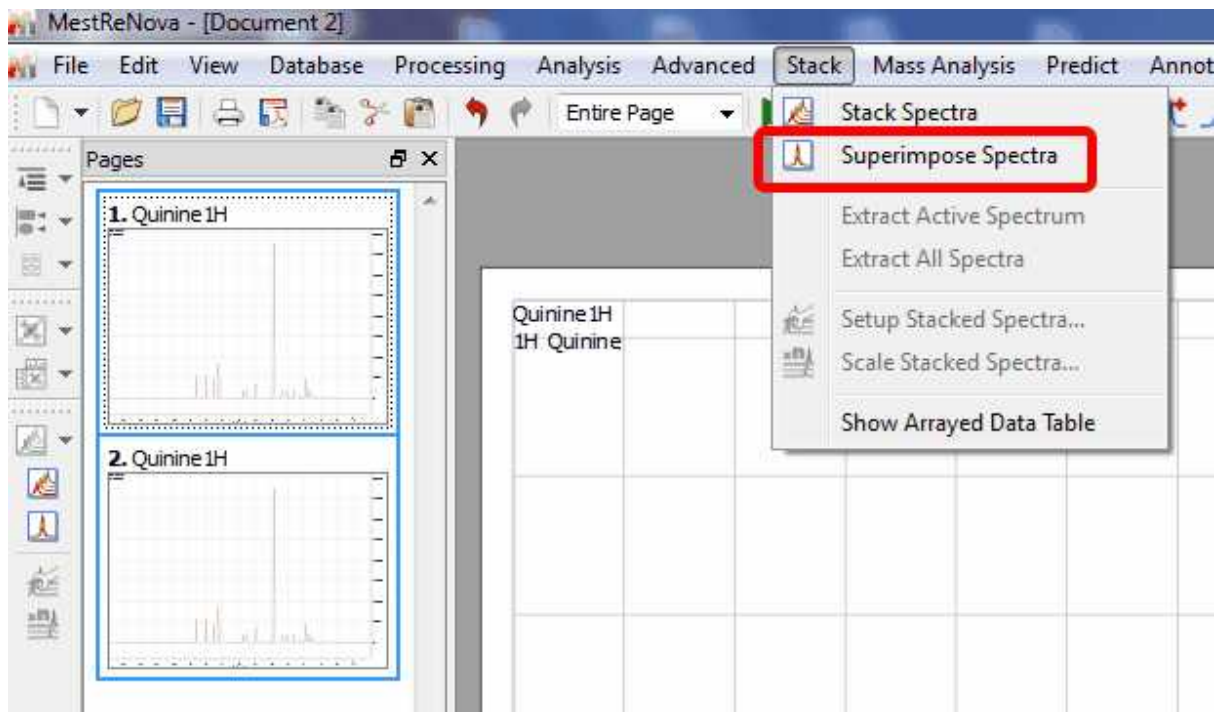

Finally, you will obtain the overlaid spectrum (one spectrum on top of the others):

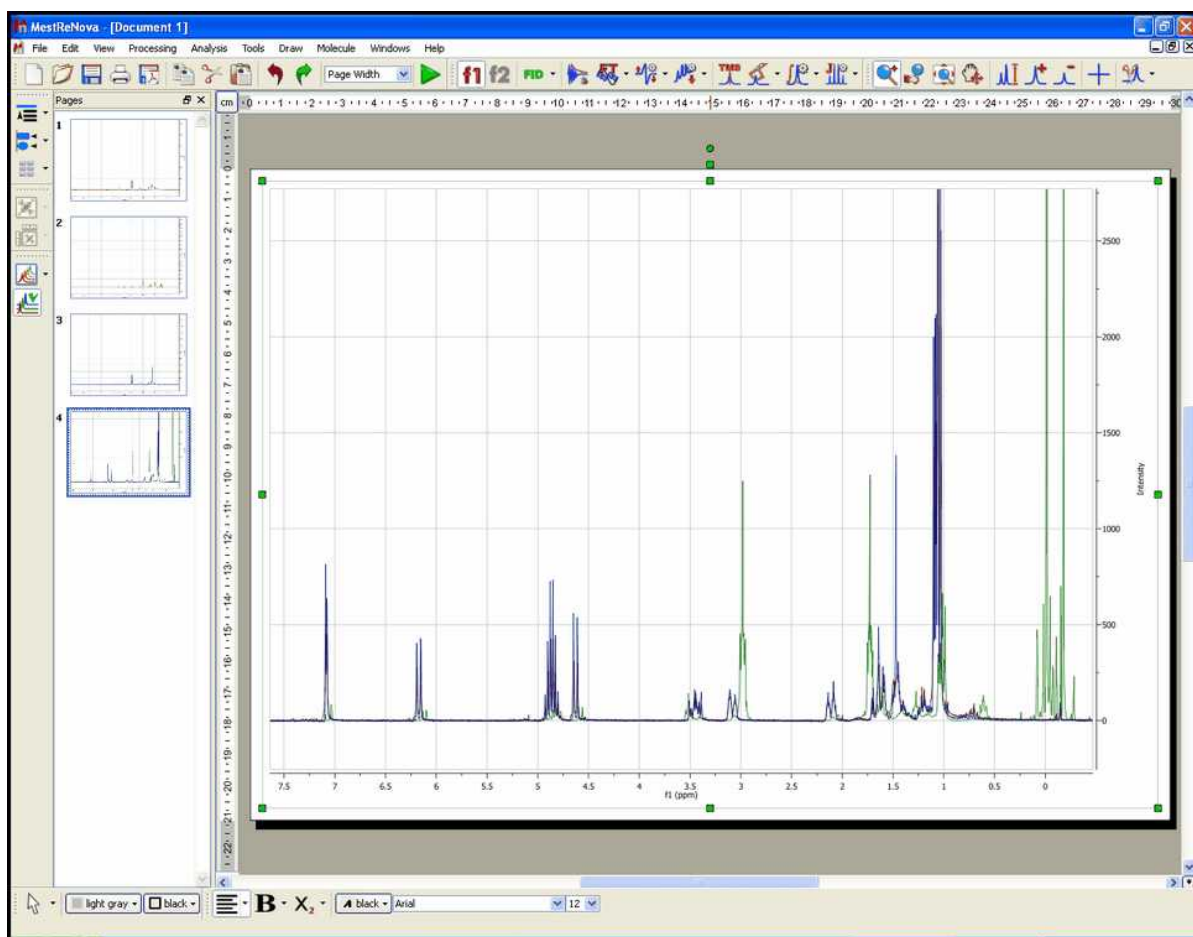

It is possible to apply any analysis feature (peak picking, integration or multiplet analysis) to the superimposed spectra and then take a look at the result over each trace by selecting 'Active Spectrum' in the 'Stacked' scroll down menu. To navigate through the traces, press and hold down **SHIFT** and use the up or down arrow key (or use the mouse scroll wheel)

You will also be able to obtain the superimposed spectrum from a stacked one by selecting '**Superimposed**' on the stacking mode (vertical-left toolbar) or by following the menu 'View/Stacked Mode/Superimposed':

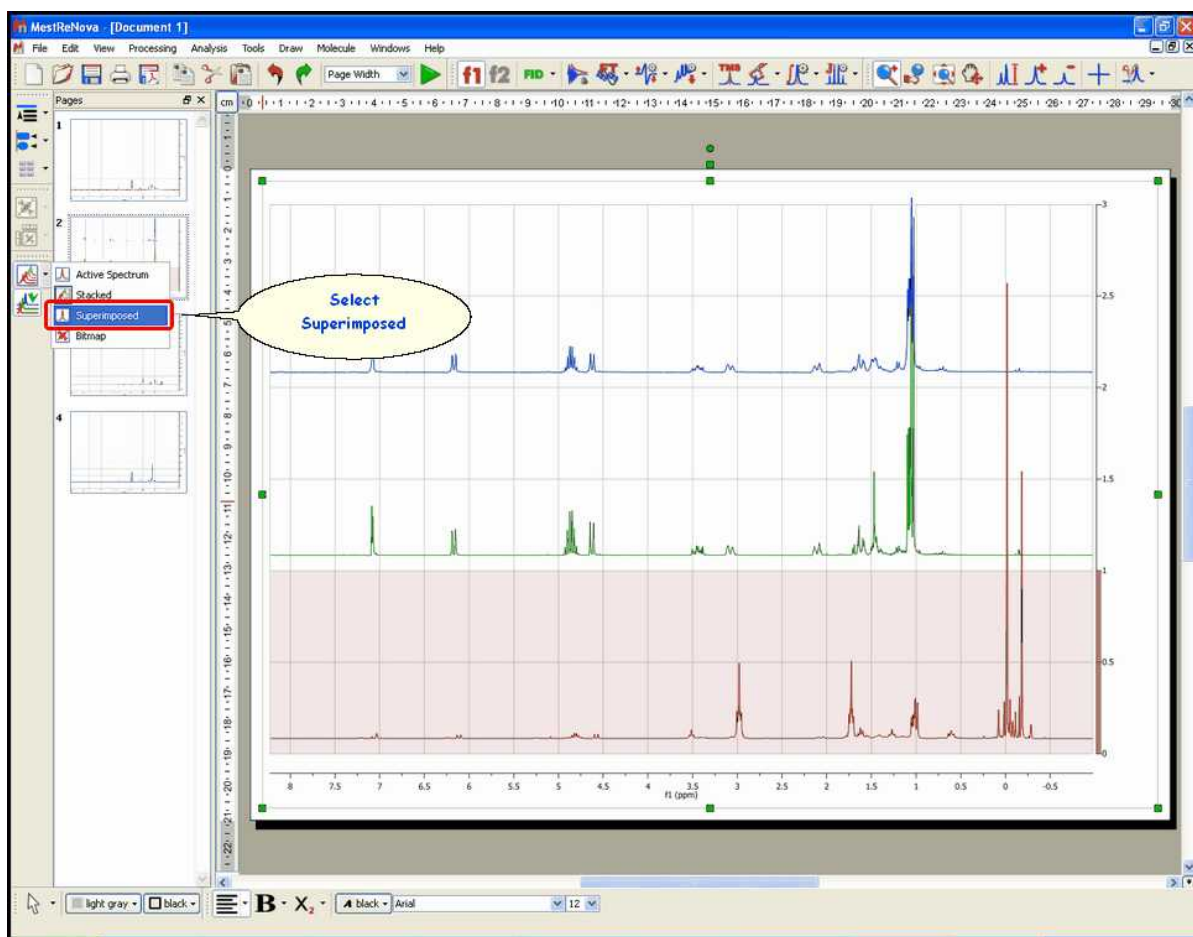

If you have several spectra on the same page (to obtain it, just paste the desired spectra to one page, by using CTRL+C, to copy, and CTRL+V, to paste), you can also superimpose them by following the menu 'Edit/Alignment/Align Left (or by using other alternatives in the vertical-left toolbar) after having selected all of them (by CTRL+A, or Edit/Select All)'.

13.4 How to process Varian DEPT spectra?

This tutorial will show you how to process a Varian DEPT spectrum. As you well know, the DEPT pulse program in Varian generates a stacked plot with four slices, acquired with phase of the last pulse equal to 45, 90, 90, 135 degrees.

When you load this kind of spectra into Mnova, you will obtain something like this:

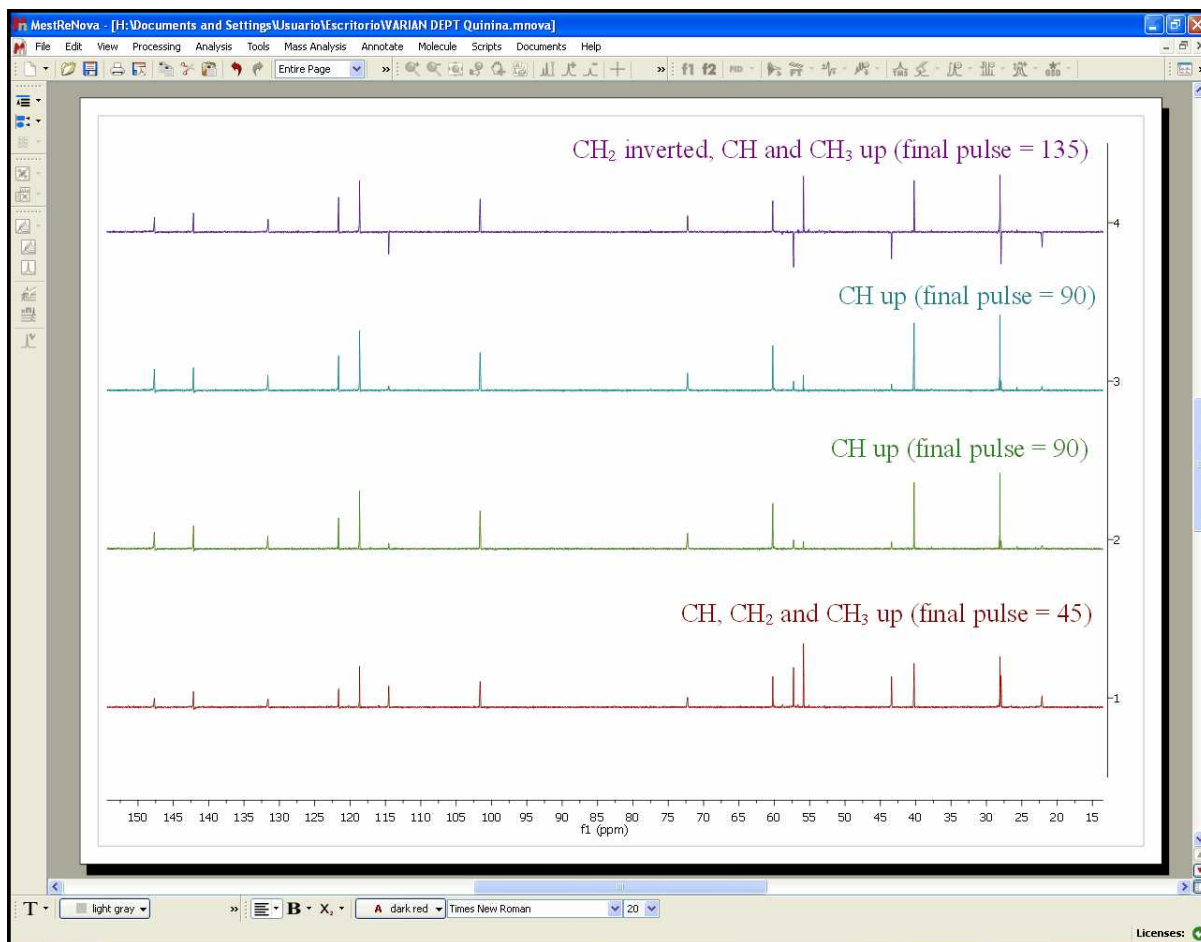

As you can see, you will have in the first slice (red slice with final pulse: 45 degrees) all the protonated signals, in the second and third slices you will get only the CH signals up and in the fourth slice (purple slice with final pulse of 135 degrees) a spectrum with the CH and CH₃ up and the CH₂ down

Then, please make sure that the phase of all the slices is right. If not, you will need to apply a phase correction. We recommend you to select 'Active spectrum' in the sixth button of the left-vertical toolbar:

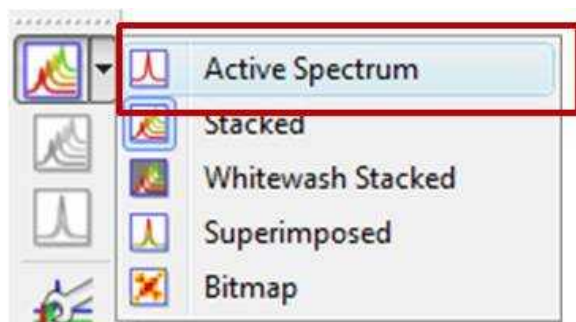

While working on this mode, you will see on the screen just the active spectrum (the spectrum which is highlighted in green in the stacked plot). Should you want to move to another spectrum without resorting to the stack mode just press Shift+Mouse Wheel or Shift + Up/Down keys.

We are going to correct slightly the phase of the first slice (the phase of the other slices will be automatically corrected):

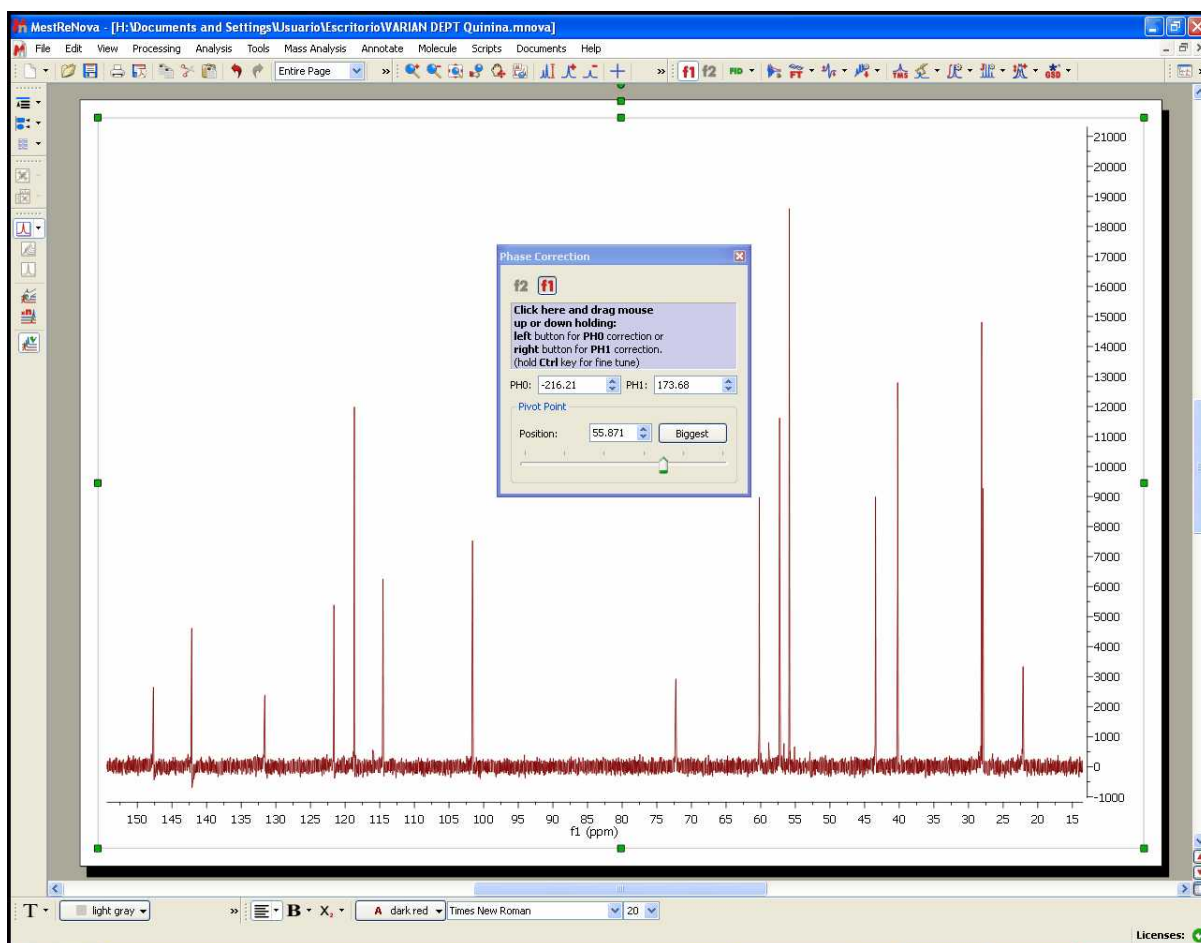

IMPORTANT

Remember that even if only the active spectrum is visible, unless the “Apply Processing to All spectra in Stack” option is off, all spectra in the stack will also be processed.

Finally, follow the menu 'Processing/Arithmetics' and enter the following formula:

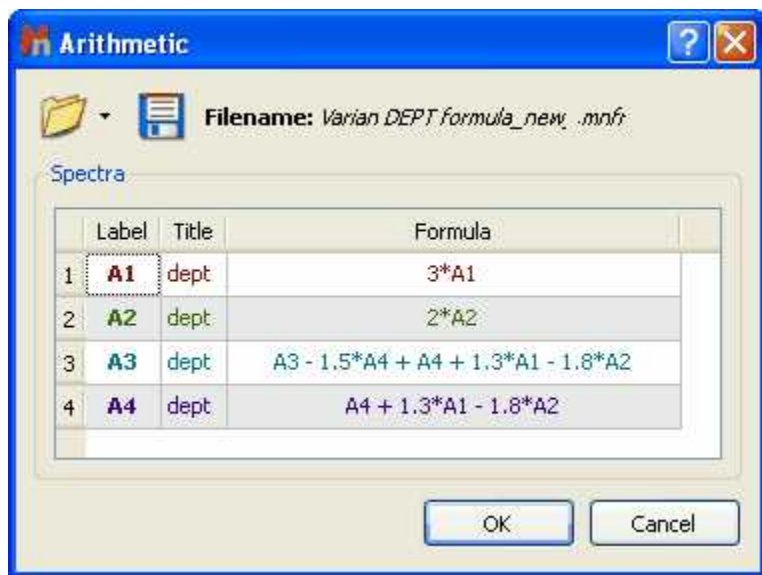

Please bear in mind that you can save this formula by using the 'Save' button .

After having applied the arithmetic formula, you will obtain all the protonated carbons in the first slice (red), the CH in the second slice (green), the CH₂ in the third one (blue) and the CH₃ in the fourth slice (purple), as you can see in the picture below:

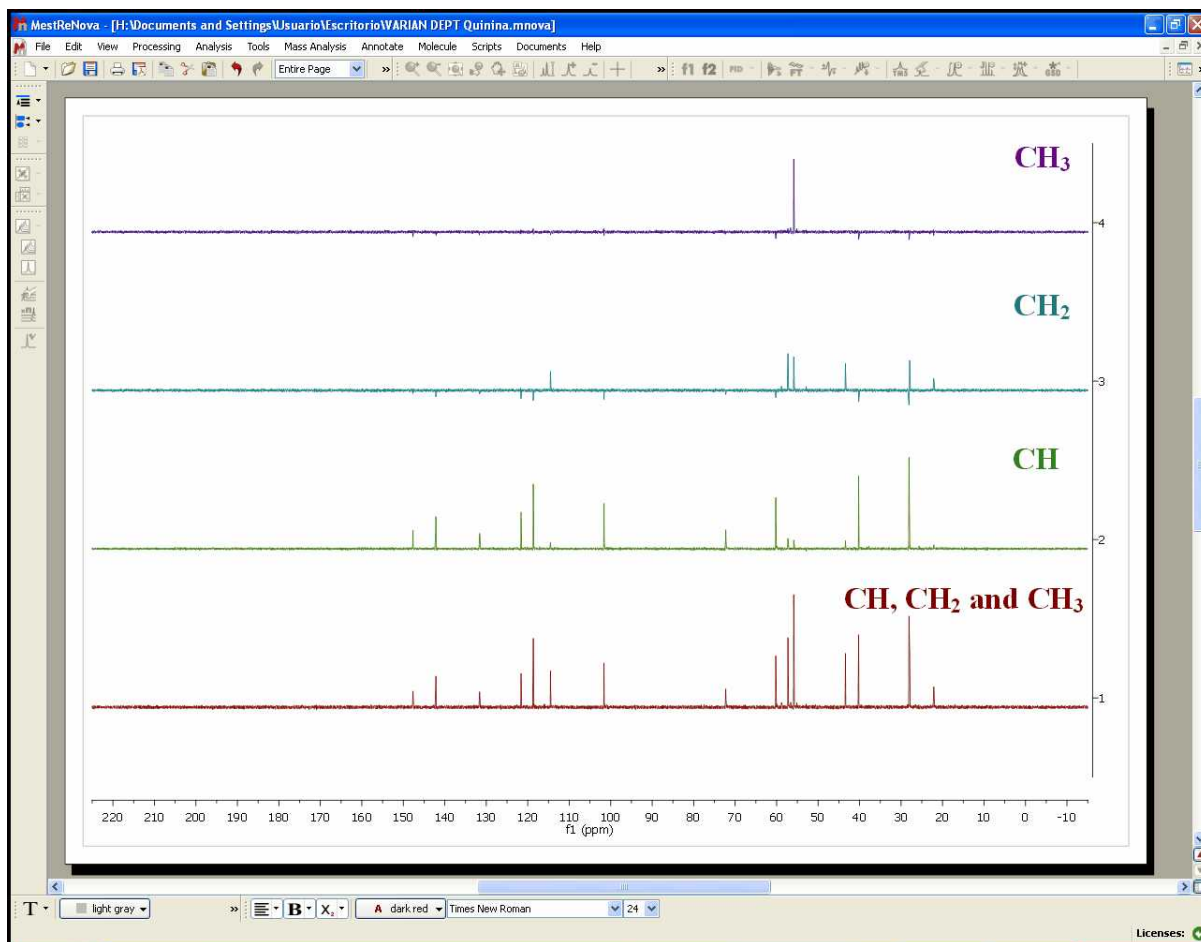

Please bear in mind that the relative intensities of the signals are not exactly the same in all the slices, so it is possible that you get small residues in some of the slices.

If your dataset shows **eight spectra** means that it contains two arrayed variables "mult" and "qphase".

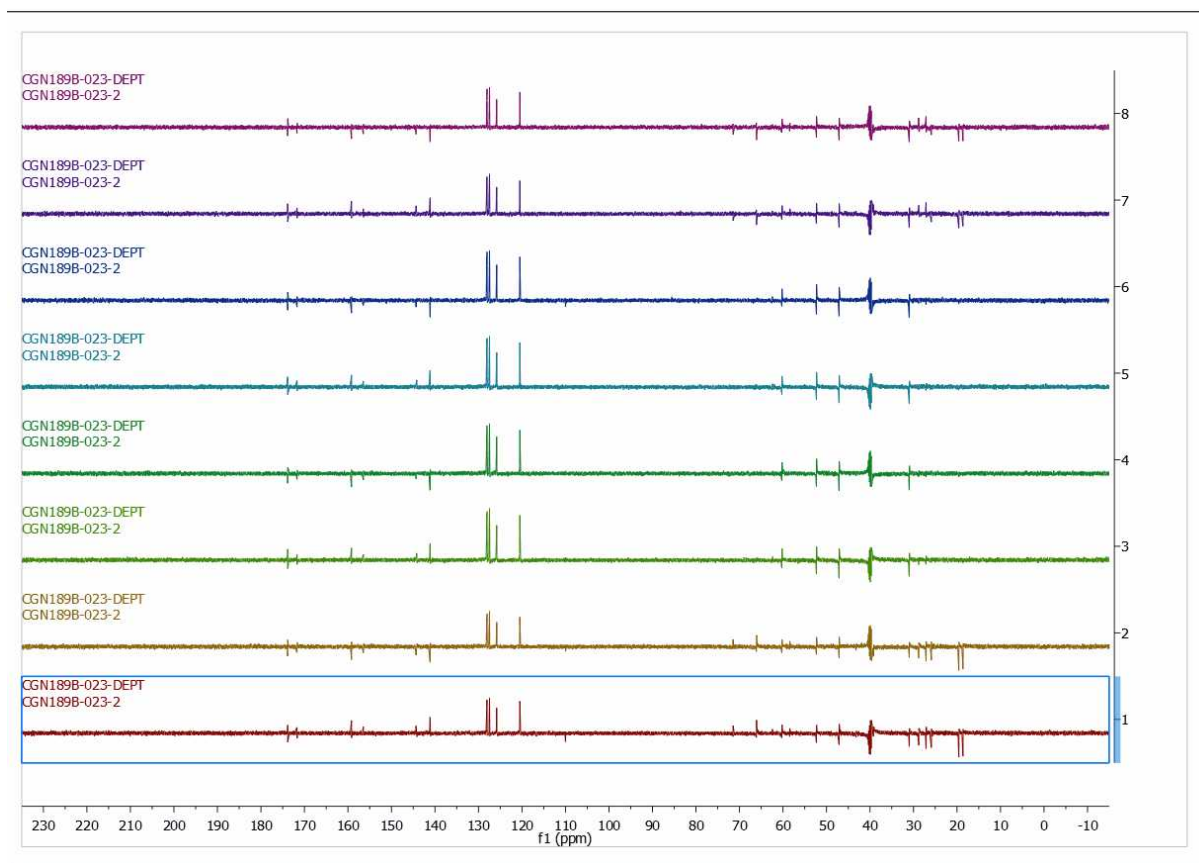

The arrayed variable mult '0.5 1 1 1.5' refers to the type of DEPT spectrum, in this case DEPTQ 45°, DEPTQ 90°, DEPTQ 90° and DEPTQ 135°, respectively
 The arrayed variable qphase '1 -1' refers to the sign of the quaternary carbons + and -, respectively.

This is the meaning of the eight spectra:

spectrum 1: +CH + CH2 + CH3 + Cq (deptq45 qphase 1)
 spectrum 2: +CH + CH2 + CH3 -Cq (deptq45 qphase -1)
 spectrum 3: +CH 0 0 +Cq (deptq90 qphase 1)
 spectrum 4: +CH 0 0 -Cq (deptq90 qphase -1)
 spectrum 5: +CH 0 0 +Cq (deptq90 qphase 1)
 spectrum 6 : +CH 0 0 -Cq (deptq90 qphase -1)
 spectrum 7 : +CH -CH2 +CH3 + Cq (deptq135 qphase 1)
 spectrum 8 : +CH -CH2 +CH3 - Cq (deptq135 qphase -1)

By doing arithmetics with the 8 spectra you can obtain the edited spectra.
 For instance the following combinations:

Only Cq: 1 -2 +3 -4 +5 -6 +7 .7
 Only protonated carbons: 1 + 2
 Only CH = 3 +4 +5 +6
 Only CH2 = 1 + 2 -7 - 8
 All carbons = 1

However we have created a script to process those kind of DEPT. You will be able to run the script by following the menu 'Scripts/NMR Tools/DEPTQ traces'.

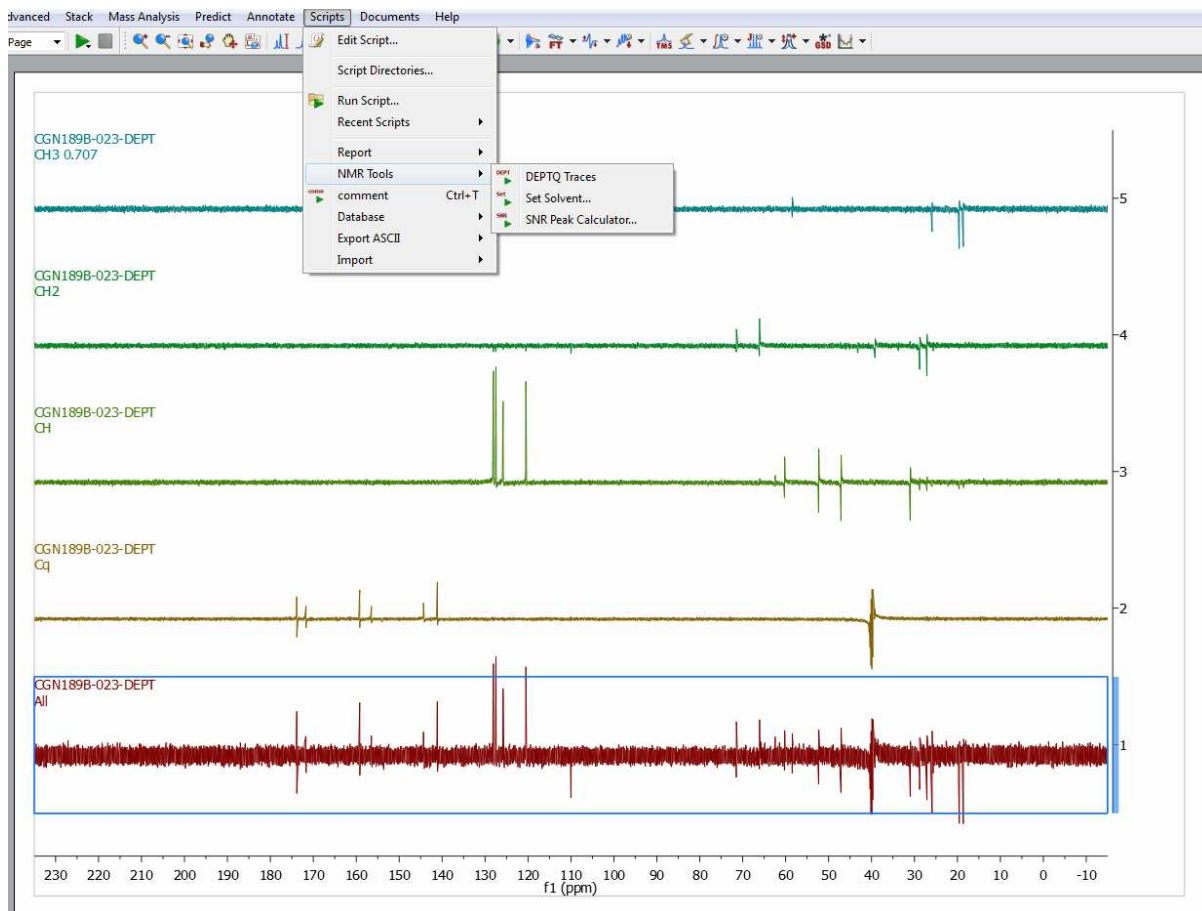

After having run the script, a phase correction may be needed. If you need to apply a different phase correction for each trace, just hold down the Alt key and click on the desired trace (or open the Stacked Spectra Table) to finally correct the phase:

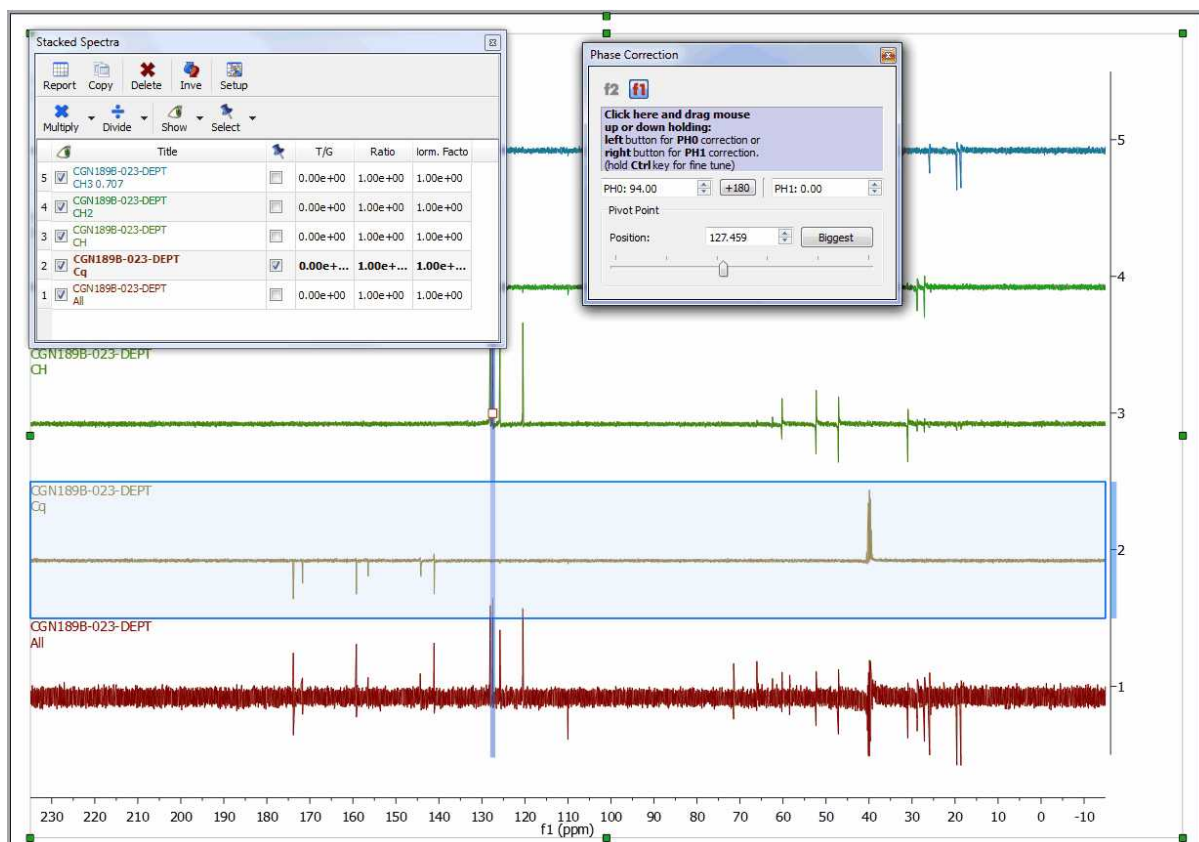

After having corrected the Phase to all the traces, this will be the result (from up to down: CH3, CH2, CH, quaternary and All carbons):

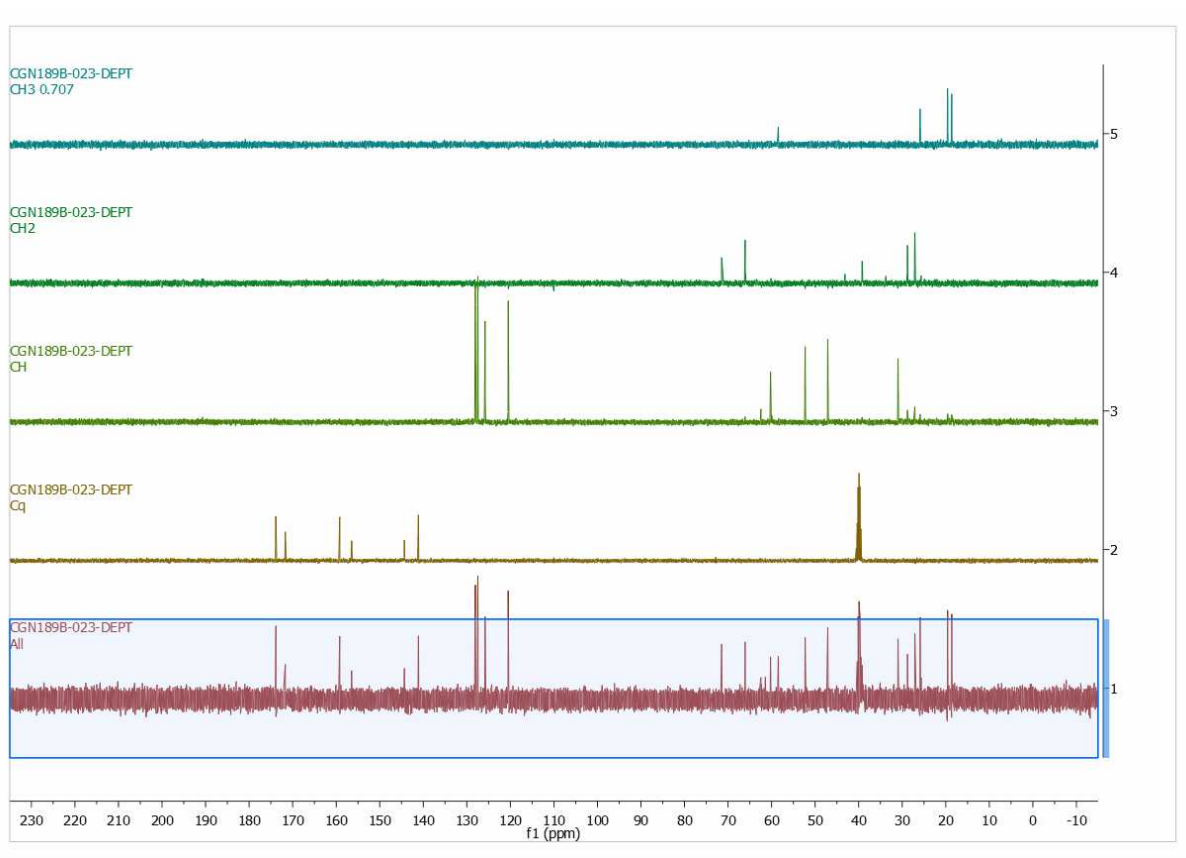

13.5 Mnova for metabonomics

Mnova allows you to easily process large datasets with the best quality in order to obtain the most precise results. Once datasets have grown to 20-200 spectra, **manual processing is no longer an option**.

Mnova can automate the processing of **large datasets of biofluids** to extract an ASCII file ready for the statistical measurement.

Mnova includes powerful specific **Phase and Baseline Correction algorithms for 1D and 2D biofluid spectra** in order to get the correct quantification

Getting Started

Mnova can be used on large datasets of biofluid spectra in two main ways, depending on the size of the dataset.

Graphical (<100 spectra): this mode allows all processing commands to be executed on a group of spectra simultaneously making possible the interaction with all spectra at the same time.

Scripting (>100 spectra): the user will only need to open a single spectrum of the dataset and optimize the processing in order to apply it to the remaining spectra by using the scripting capability implemented in Mnova.

Processing Basics

Let's take a look at the 'graphical method'.

1. When the dataset is small, we can drag the spectra folders to Mnova in order to get all the spectra fully processed (you can also use the multiOpen script). In this case I have dragged 16 spectra folders to the Mnova icon. After about 5 seconds, I got all the spectra fully processed as you can see in the picture below

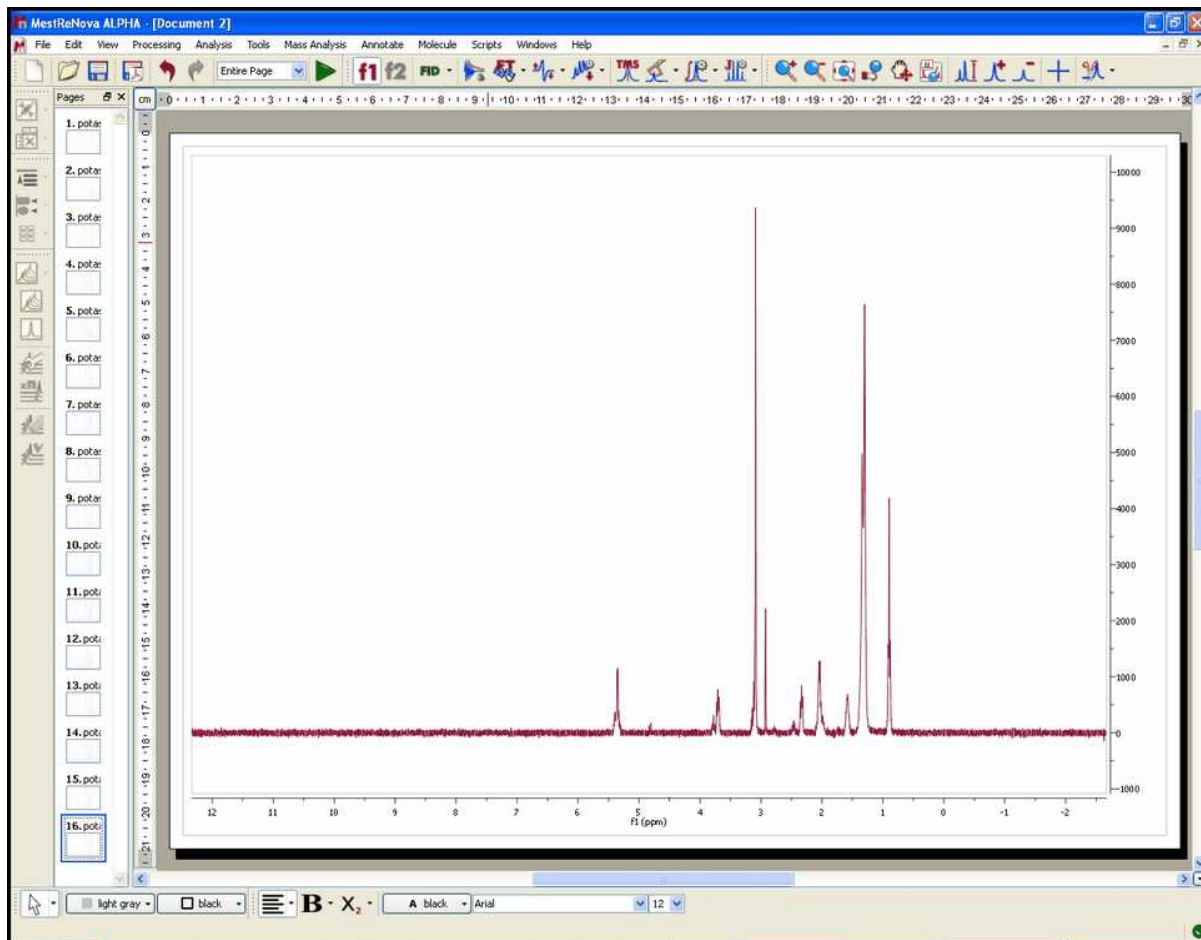

2. Select all the spectra in the page navigator in order to create the stacked spectra. We can do it by pressing 'Ctrl+A' or by following the menu 'Edit/Select All' and then clicking on the 'Stack Spectra' button  (in the left-vertical toolbar) or going to the 'Stack/Stack Spectra' menu.

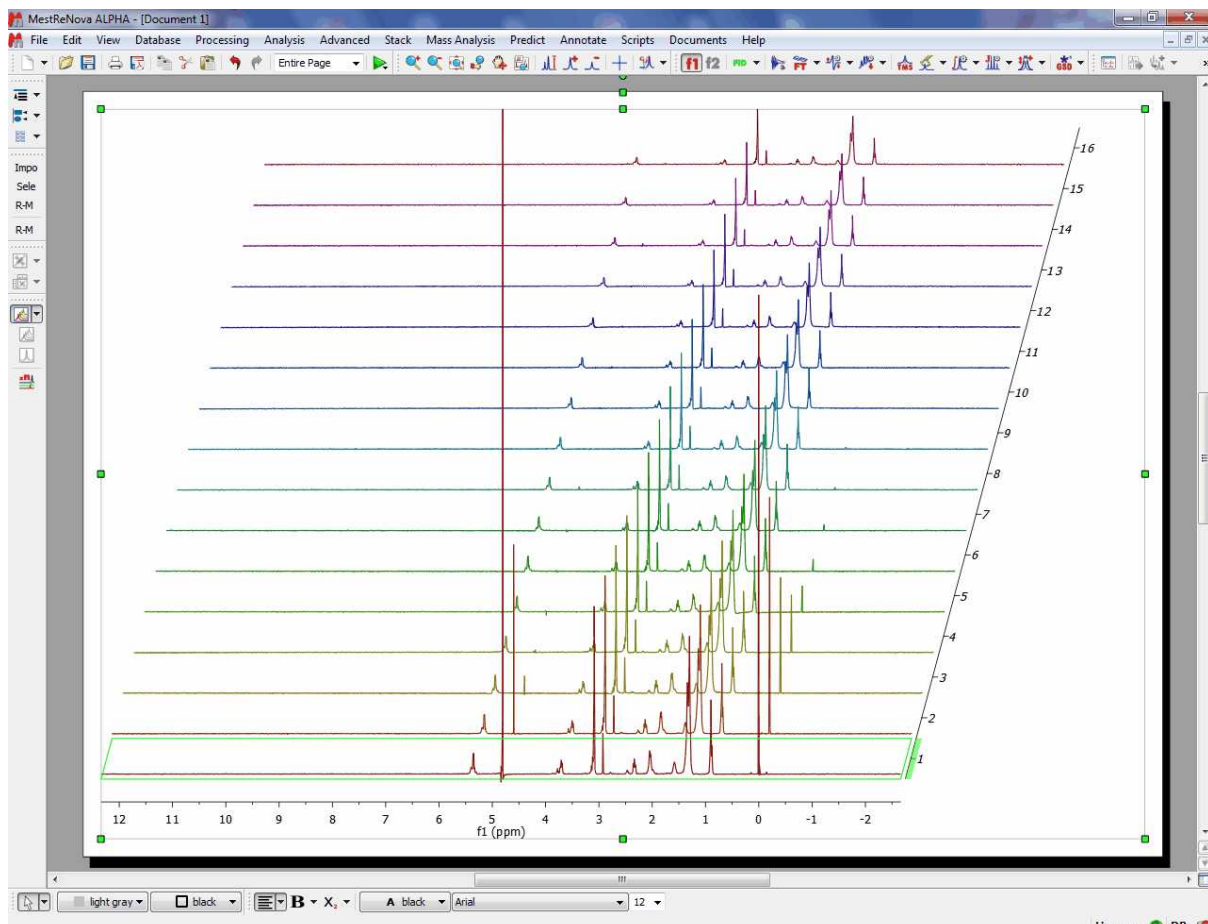

3. Select one of them (by selecting 'Active Spectrum' in the Stack scroll down menu of the left-vertical button) and apply the necessary processing and analysis (phase and baseline corrections, binning, signal suppression...). The operations to the first spectrum will be applied simultaneously over the whole dataset.

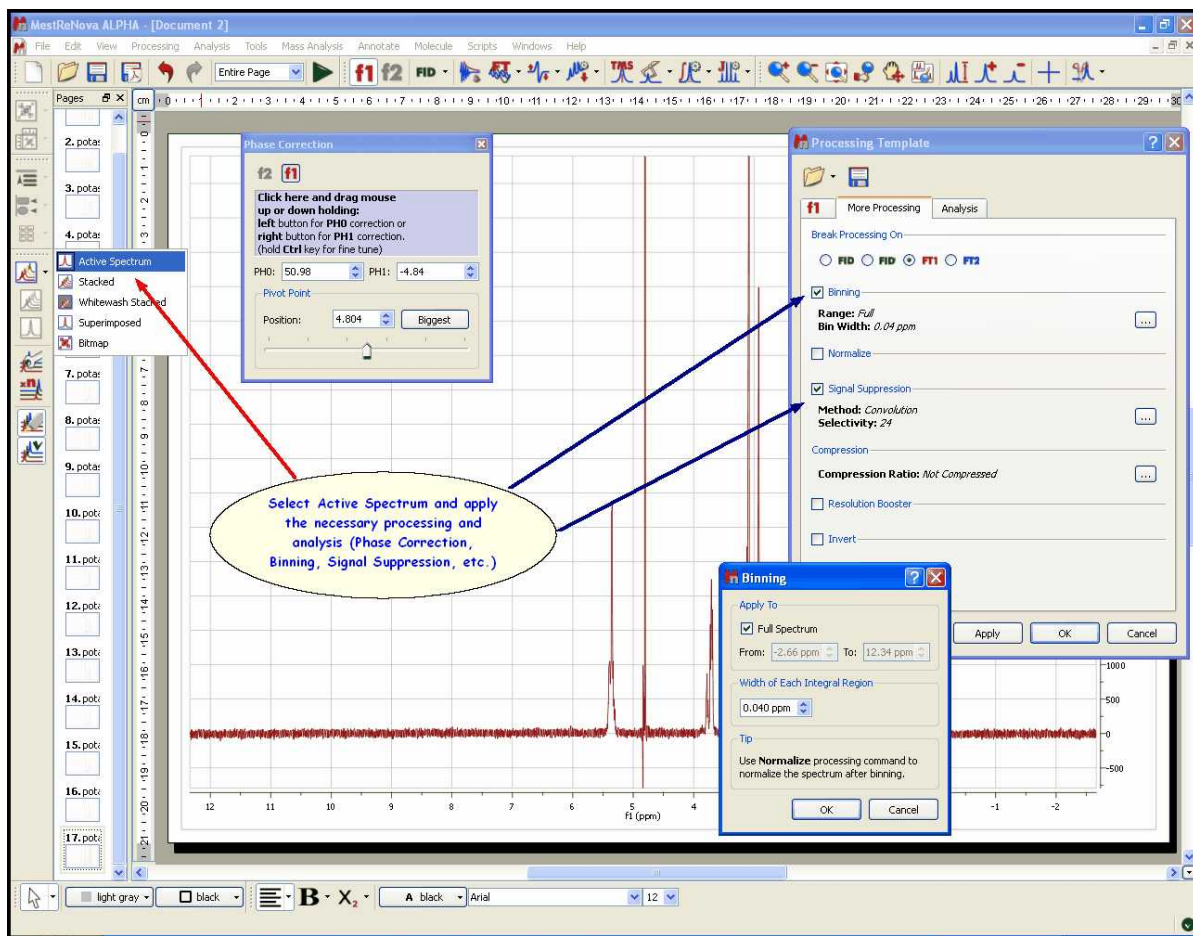

Mnova incorporates several specific features for biofluid samples; such as **Automatic Phase and Baseline corrections algorithms**, **Solvent Suppression** (to remove, for example, the dispersive signal of the water), **Auto-tuning referencing**, **Binning** (or bucketing), **Normalize**, **Global Spectral Deconvolution** (work in progress).

4. Once the processing and analysis have been made, we can export to an ASCII file for the PCA or PLS, just by following the menu 'File/Save As/ASCII text file (*.txt)'.

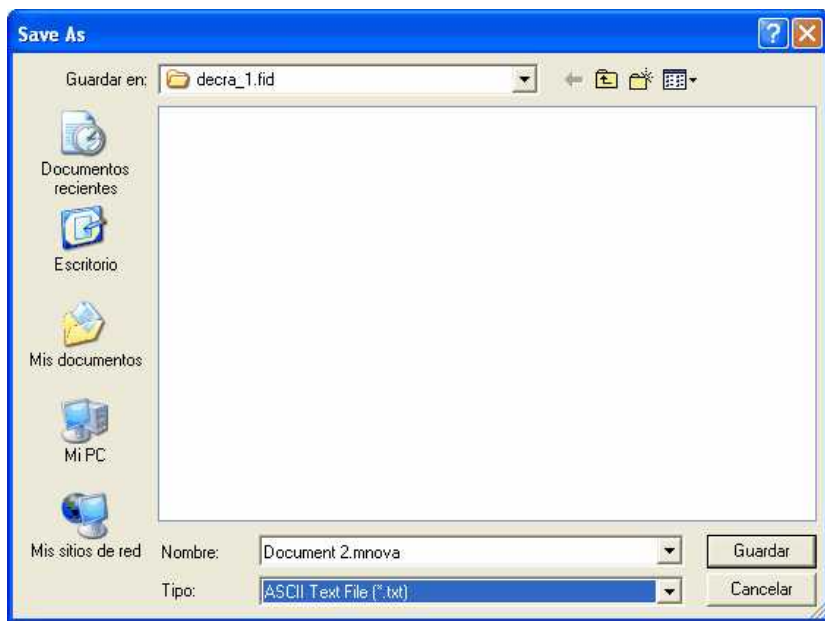

It will be possible to superimpose all the spectra to double check for example that all spectra are perfectly aligned or referenced. To do that, just highlight the stacked spectra and go to the menu 'Stack/Superimpose Spectra':

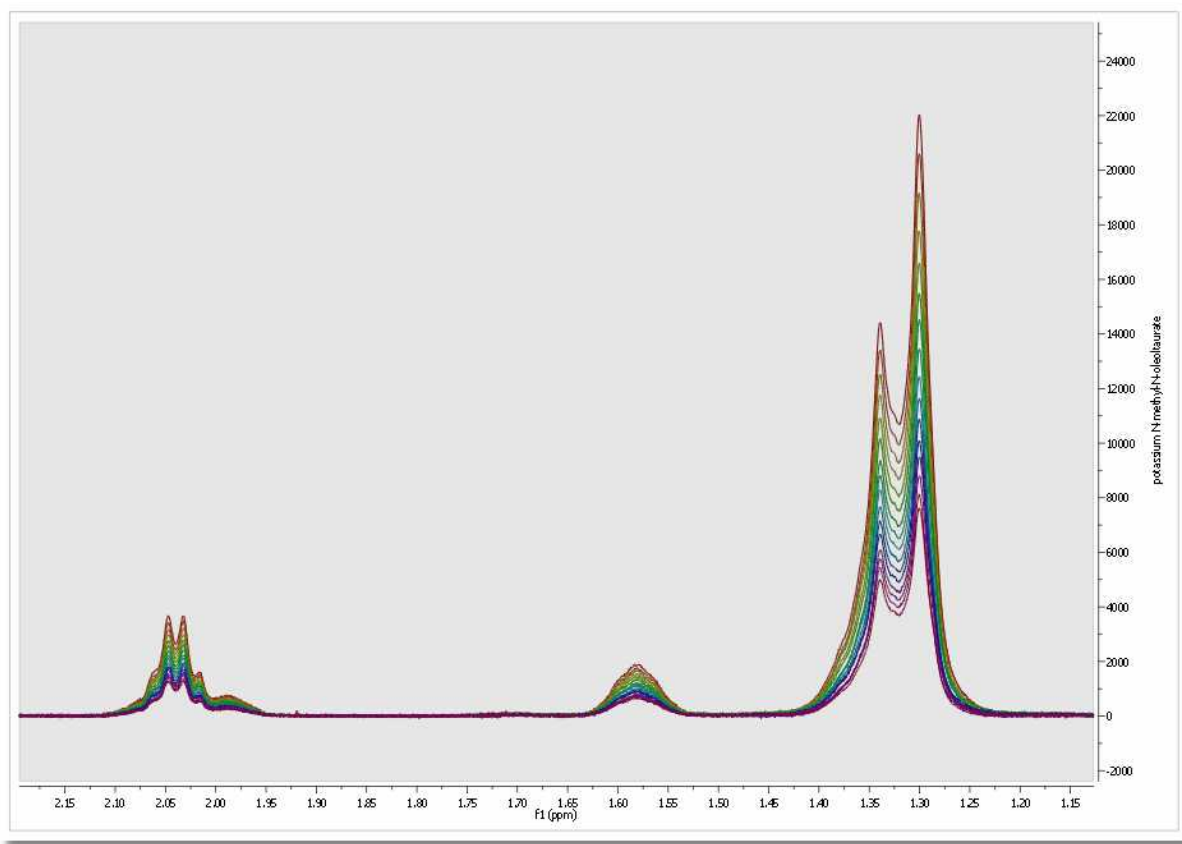

Scripting Method

Let's take a look at the **'Scripting method'**.

Mnova includes **Scripting capabilities** to automate the previous process with the ability to create Processing Templates which can be used with our Script engine to perform batch processing.

Mnova includes a powerful and flexible feature which allows the user to easily automate the full processing of both 1D & 2D NMR data sets. This is ideal for the batch processing of spectra of the same type, and can also incorporate analysis operations.

For example, let's say you have acquired 20 proton spectra which you want to process using the same processing operations. The procedure is very simple:

1. Load one spectrum and process it as desired.
2. Go to **Processing/Full Processing**. The following dialog appears:

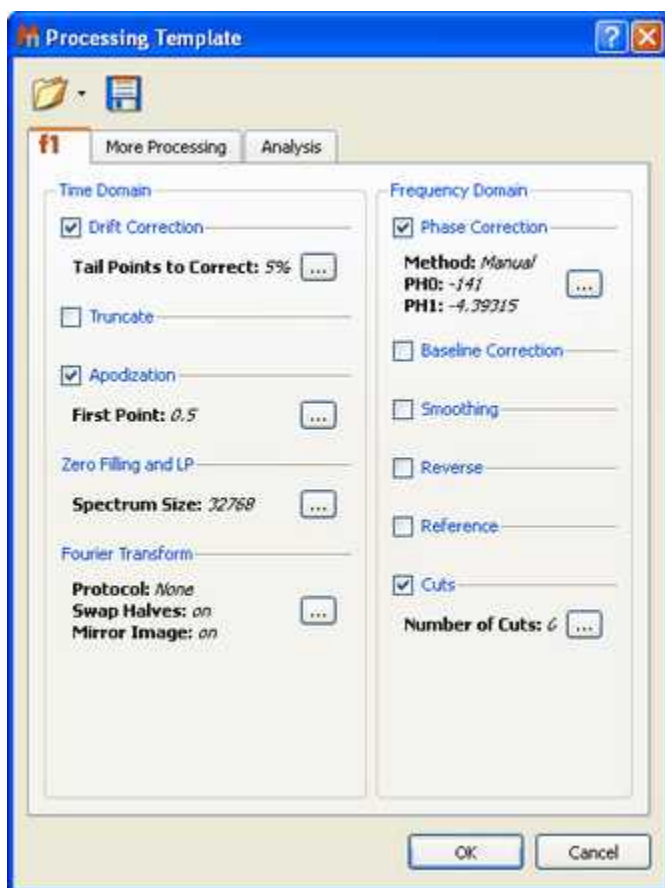

This dialog includes all the processing and analysis features implemented in **Mnova**. You can choose the required options by selecting the check boxes and, if necessary, specify options by clicking the button next to the corresponding command.

3. Once you are happy with the result, **save** the script file to a Mnova Processing file (*.mnp) by clicking on the save button in the dialog box.

Once you have saved this template, you will be able to run a script to process all the spectra in the same way.

If the number of datasets is too large, Mnova is able to open, process (apodization, FT, Zero Filling,

LP, phase and baseline Correction...), analyze (binning, etc.), save to an ASCII file and close the spectrum, in order to open the next one and continue with the processing (to avoid an excessive use of memory). If the number is not large, Mnova can keep all the spectra fully processed on screen.

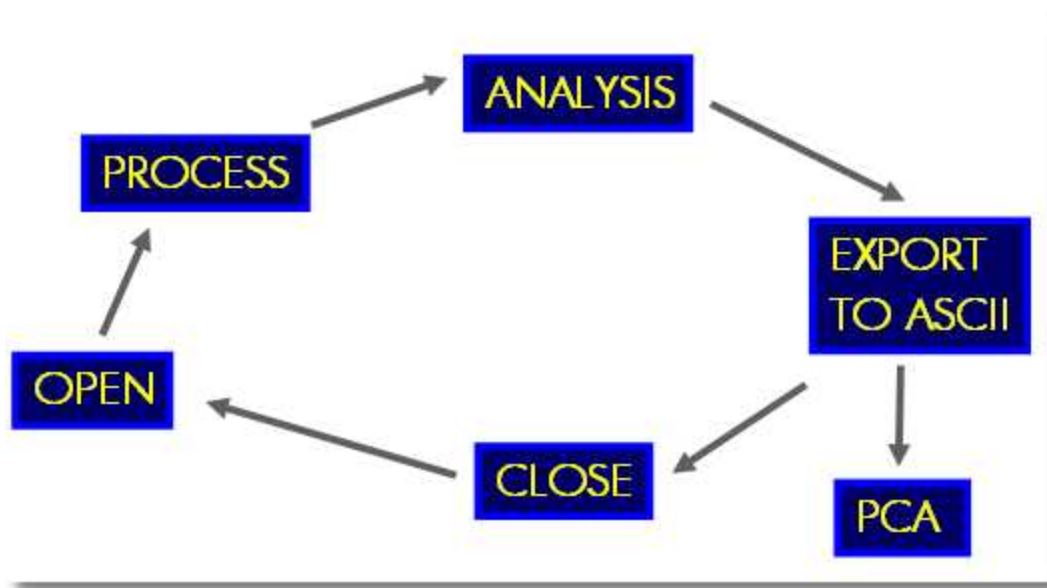

You can use the below script to automate the above process and save all the result into the same ASCII file. You will be able to download it [here](#)

Copy this script to the scripts folder of Mnova, restart the software and the script will appear under the 'Scripts' menu.

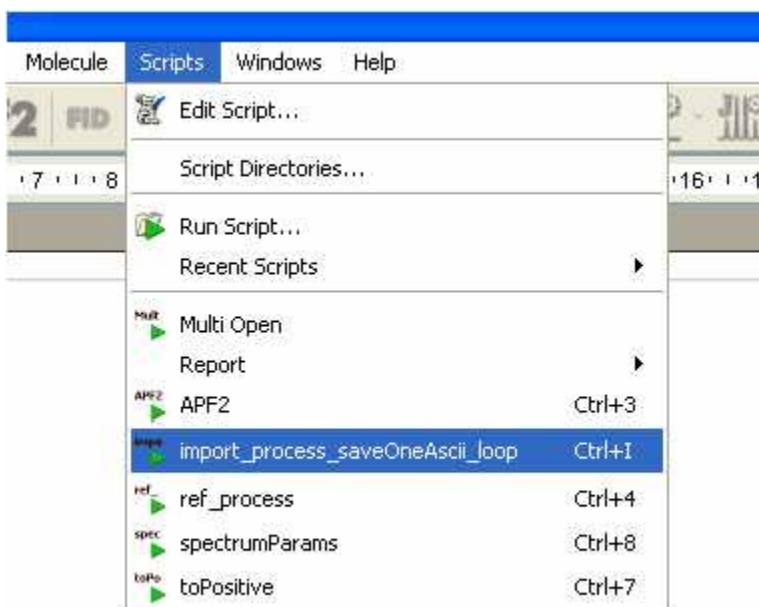

Please bear in mind that you can introduce this script into the toolbar by using the 'Toolbar

Customization' feature (View/Toolbars/Customize Toolbars').

To read more about Mnova scripting, please click [here](#)

```
//<GUI menuname="import_process_saveOneAscii_loop"shortcut="Ctrl+I"tooltip="Auto Process and
Save as ASCII"/>
/*****
Copyright (C) 2008 Mestrelab Research S.L. All rights reserved.
This file is part of the MNOVA scripting toolkit. Authorized users of MNOVA Software may use
this file freely, but this file is provided AS IS with NO WARRANTY OF ANY KIND, INCLUDING THE
WARRANTY OF DESIGN, MERCHANTABILITY AND FITNESS FOR A PARTICULAR PURPOSE.
*****/
// This example function demonstrates how to apply some processing to a set of spectral files
and to save the result in a single ASCII file.
function import_process_saveOneAscii_loop()
{
    const procName = "c:/procTemplates/proc.mnp"; // Processing file. It must be created
in the Processing Template dialog of MestReNova.
    const fileMask = "fid"; // This mask specifies files to be processed.
    const dirMask = "*"; // This mask specifies directories to be scanned for spectra.

    // Select a directory with spectral data
    const specDirKey = "import_process_saveOneAscii_loop/SpectraDir";
    var dirName = FileDialog.getExistingDirectory(settings.value(specDirKey, Dir.home()),
"Select Spectra Directory");
    if (!dirName)
        return;
    var dir = new Dir(dirName);
    dir.cdUp();

    // Select a file to save the output
    const outDirKey = "import_process_saveOneAscii_loop/OutputDir";
    var saveDir = settings.value(outDirKey, Dir.home()); // Get last used directory name
    var fileName = FileDialog.getSaveFileName("ASCII Files (*.txt)", "Select Output File",
saveDir);
    if (!fileName)
        return;

    // Open the selected file and create a text stream mapped to it
    var fout = new File(fileName);
    settings.setValue(outDirKey, fout.absDirPath); // Save the directory name to be used
another time the script is called
    var sout = new TextStream(fout);
    sout.precision = 10;

    // Temporary file name
    const lastOutName = Dir.temp() + "/import_process_saveOneAscii_loop.lastOut.tmp";
    if (File.exists(lastOutName))
        File.remove(lastOutName);

    // The below function getMaskFiles is located in the files.js script.
    var files = getMaskFiles(dirName, dir.absPath, fileMask, dirMask, true);
    for(var fi = 0, length = files.length; fi < length; fi++)
    {
        var dw = new DocumentWindow(Application.mainWindow.newWindow()); // Create new
document window
        if (serialization.open(files[fi]))
        {
            nmr.process(procName); // Apply processing template
            var spec = new NMRspectrum(nmr.activeSpectrum());

            fout.open(File.WriteOnly);

            var flastOut = new File(lastOutName);
            var slastOut = new TextStream(flastOut);
            if (!fi)
            {
                // Put fist column of the file in ppm. The scale is taken from
the first spectrum.
                flastOut.open(File.WriteOnly);
                slastOut.precision = 10;

                var ppm = spec.hz()/spec.frequency();
                var dPpm = spec.scaleWidth()/spec.count()/spec.frequency();
            }
        }
    }
}
```

```
        for(var si = spec.count()-1; si >= 0; si--)  
        {  
            slastOut.write(ppm, "\n");  
            ppm += dPpm;  
        }  
        flastOut.close();  
    }  
    flastOut.open(File.ReadOnly);  
  
    for(var si = spec.count()-1; si >= 0; si--)  
        sout.write(slastOut.readLine(), "\t\t", spec.real(si), "\n");  
  
    fout.close();  
    flastOut.close();  
    flastOut.remove();  
    if (fi < length-1)  
        File.copy(fileName, lastOutName);  
    }  
    dw.close(); // Close document window of processed spectrum  
}
```

13.6 Show Traces in 2D-NMR

The user can show the traces of the 2D-NMR spectrum, just by clicking on the **'Show Traces'** icon



(or by using the contextual menu by right clicking over the spectral window). On the same icon, you will find a scroll bar menu to setup the vertical and horizontal traces of a bidimensional spectrum. The user can increase or decrease the intensity of the traces simply by scrolling the mouse wheel, after hovering the mouse over the desired trace (or by using Ctrl+Shift+Up/Down for the horizontal trace and Ctrl+Shift+Left/Right for the vertical trace).

To move the trace, just hover the mouse over the top-right areas of the slices (the arrow cursor will change to a vertical panning cursor) and then click & drag your mouse in the desired direction. You will obtain the same result by holding the 'Ctrl' key while scrolling the mouse wheel over the trace.

It will be possible to drag and drop any currently opened 1D-NMR spectrum to a 2D NMR dataset in order to get them as traces. Here you can see how the page number 1, containing a 1H dataset is dropped to the HSQC to get the horizontal trace:

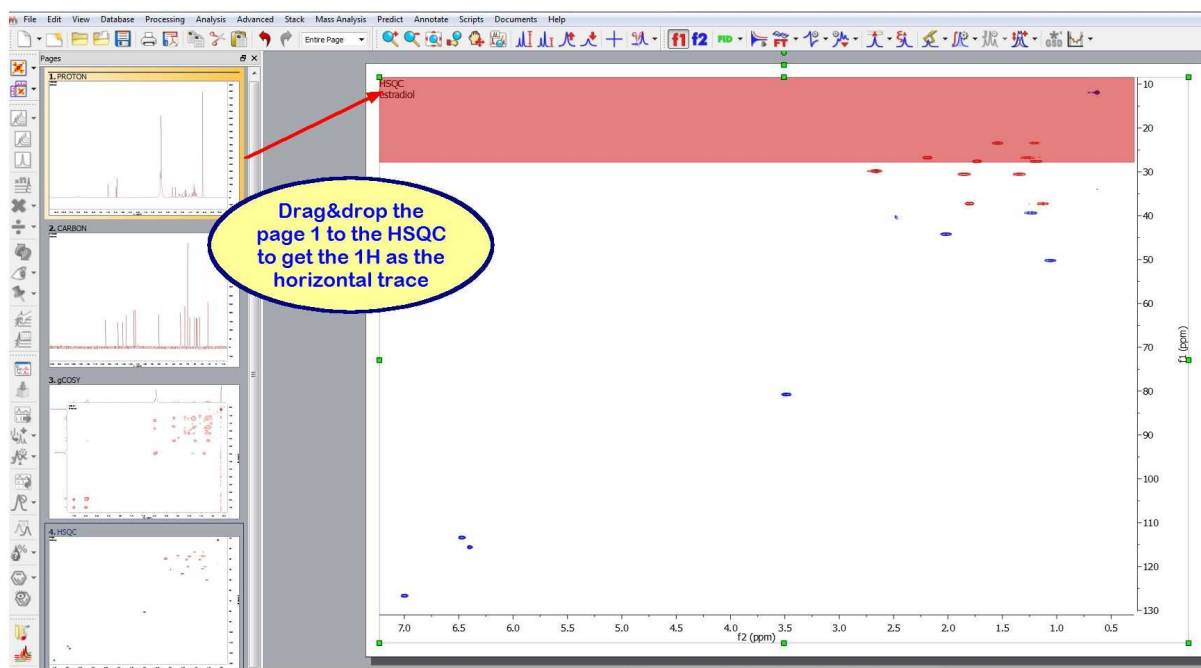

The same can be done with the page 2 (containing a ¹³C spectrum) to get the vertical trace:

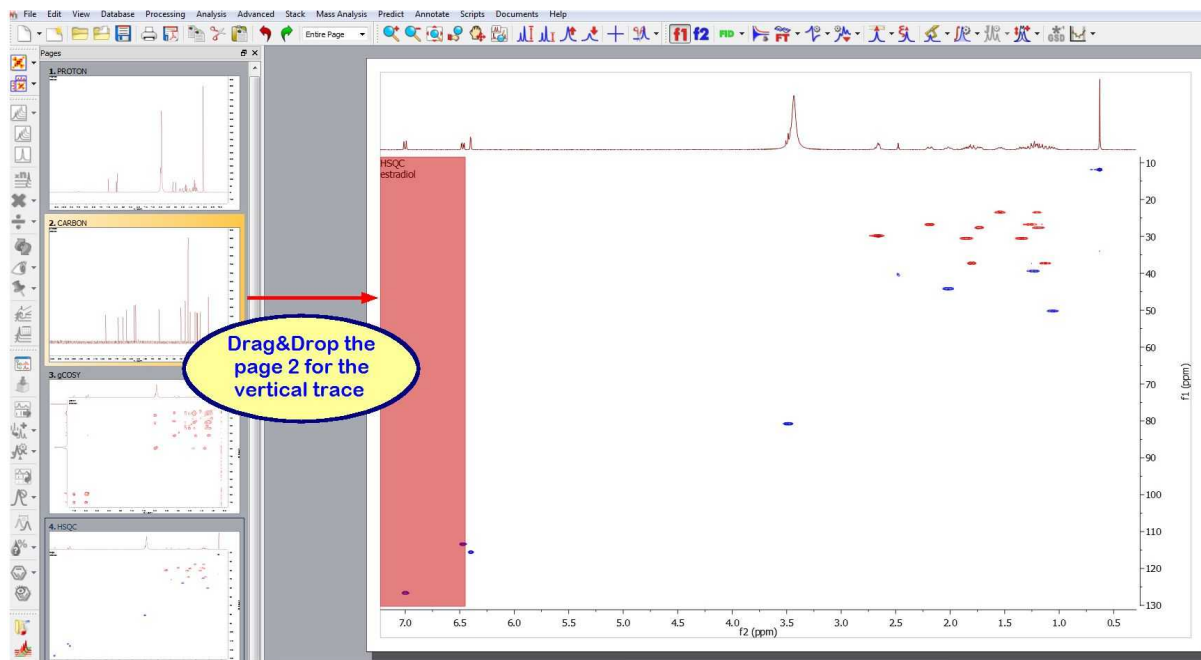

Here you can see the result:

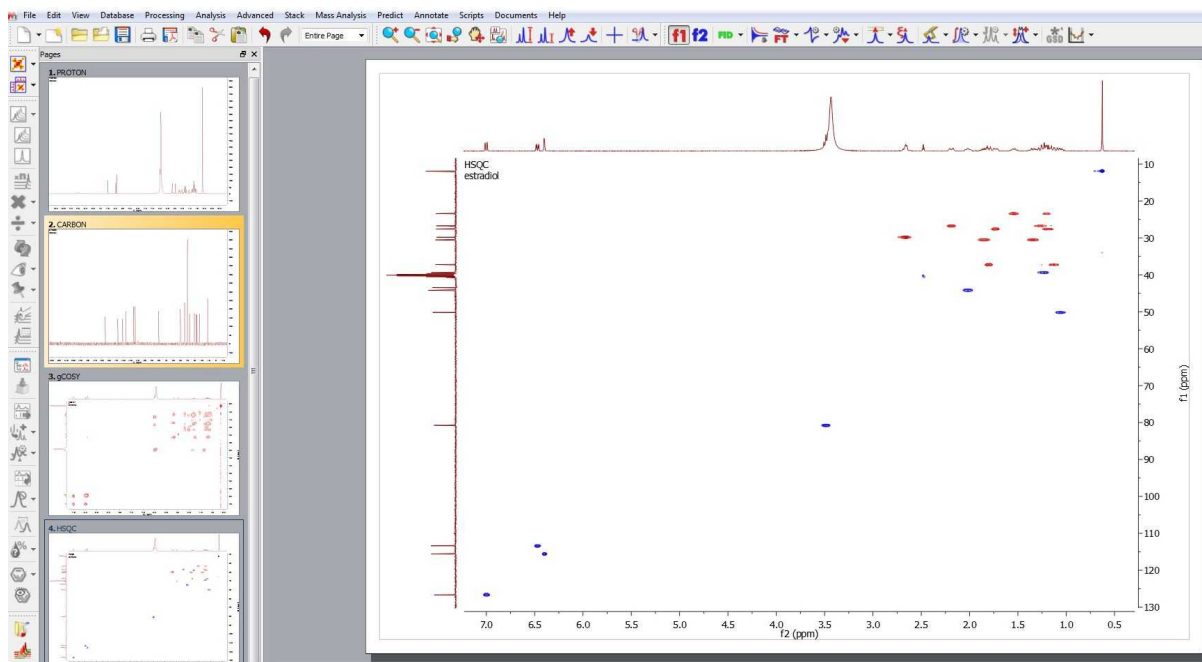

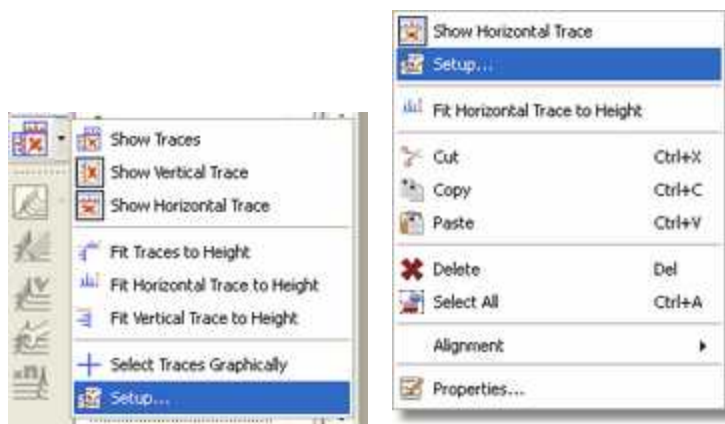

You can also choose any currently opened 1D-NMR spectrum as a trace by clicking on 'Setup' on the 'Show Traces' scroll bar menu (or by using the traces contextual menu by right clicking over one of the traces).

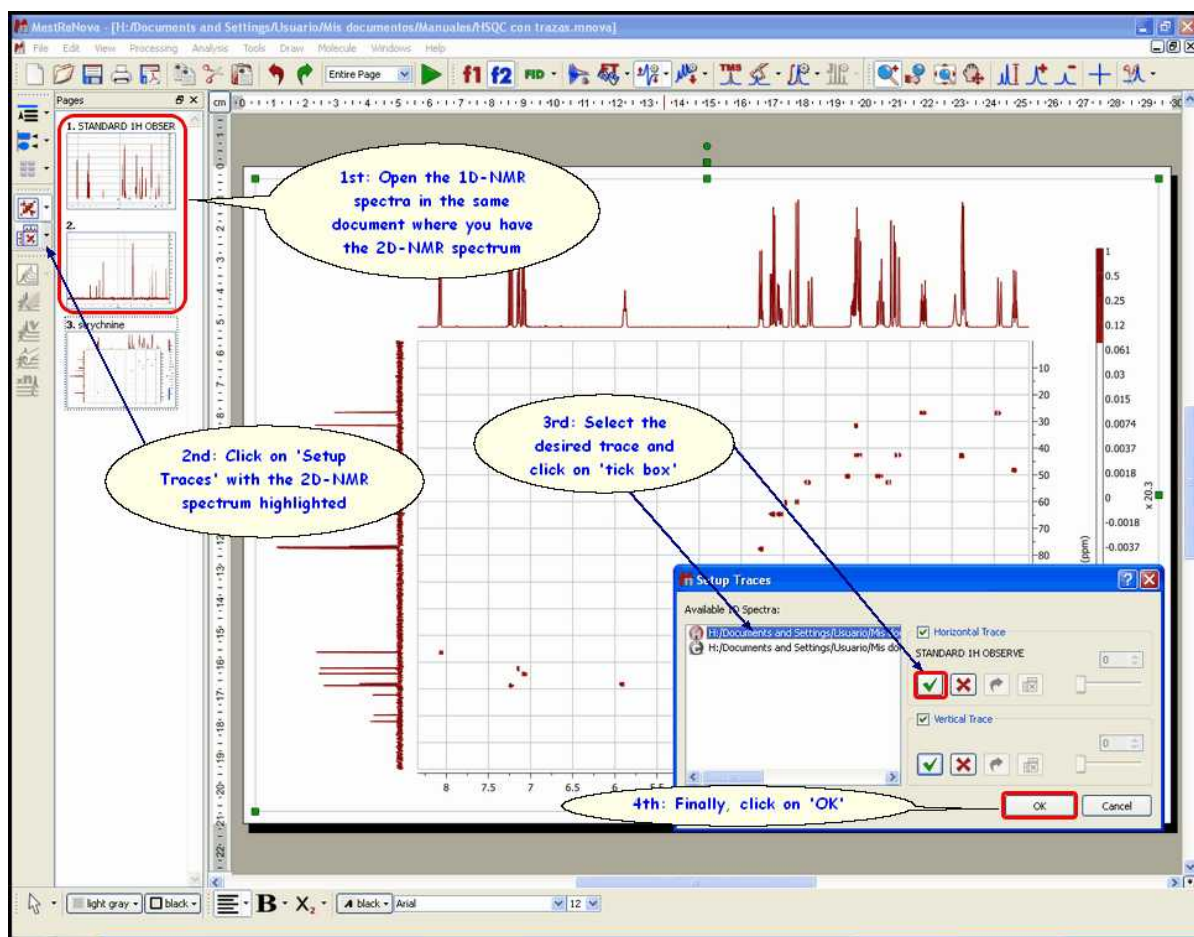

and next selecting the desired 1D-NMR spectrum for the horizontal and then for the vertical trace.



The user will be able to remove the external trace by clicking on the **'Delete'** icon .

It is now possible to show the **'Internal Projections'** in 2D spectra as either a calculation of the sum of all traces across a given dimension (Sum) or by computing the maximum of every trace (Maximum), just by clicking on the 'Projections icon' . Click again on this icon  to show the **'Internal Traces'**.

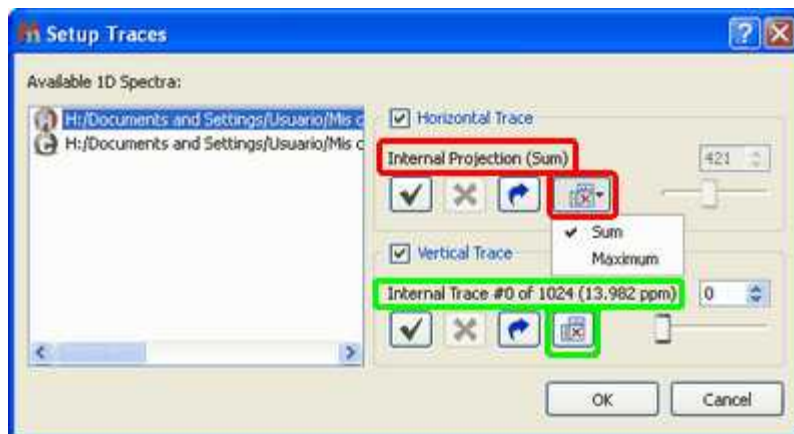

The user can also select the traces directly from the 2D-NMR spectrum by using the **'Select Traces Graphically'** tool in the 'Show Traces' scroll bar menu.

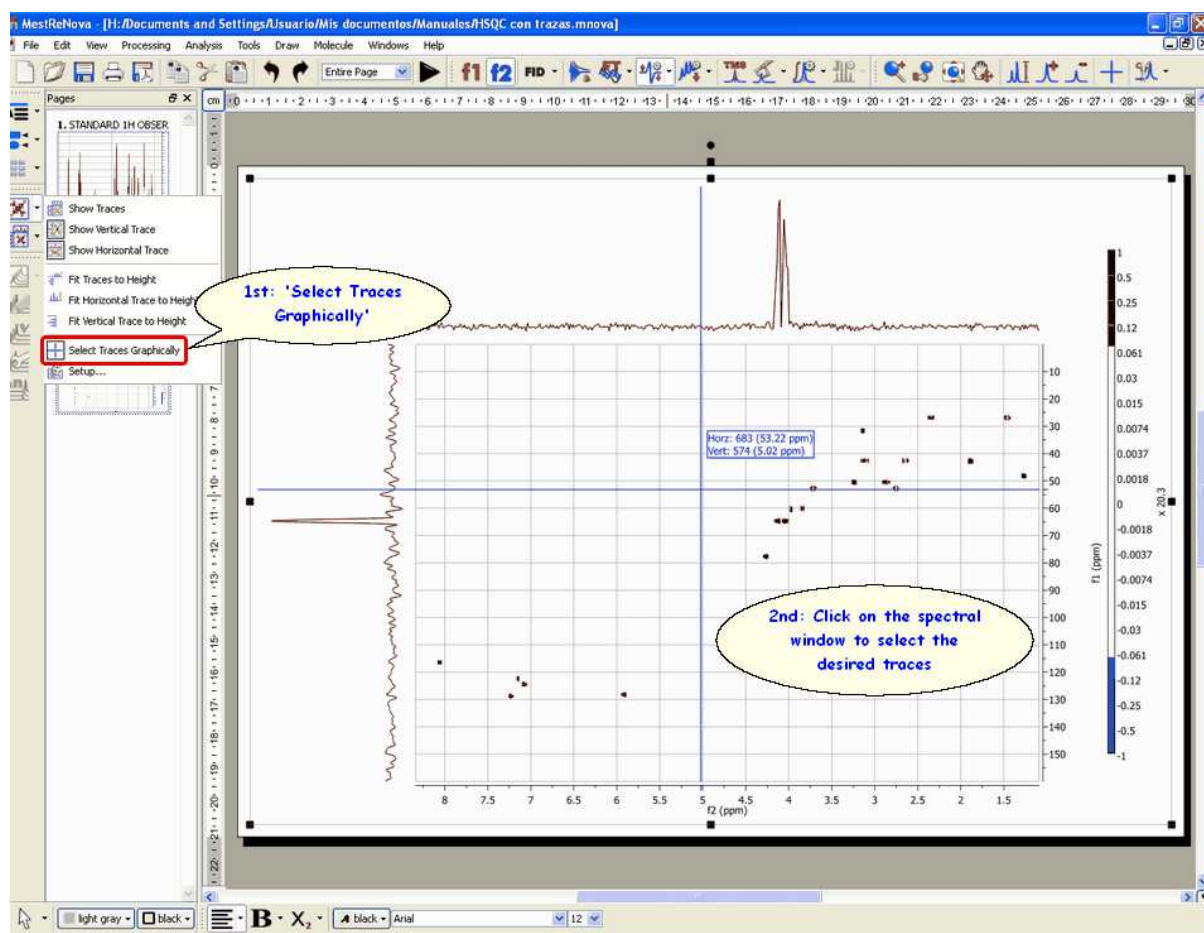

The user will be able to **'Fit Traces to Height'** (the vertical, the horizontal or both), just by following the menu 'View/2D Traces' or by using the **'Show Traces'** scroll bar menu on the left vertical toolbar:

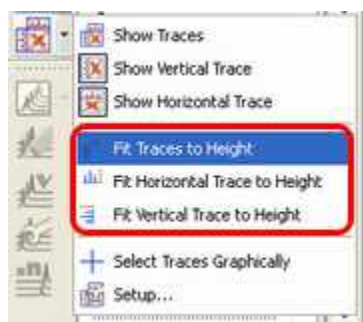

The user can also extract a current trace (or projection) as a new spectrum by clicking on the button  in the 'Setup traces' dialog box. In the figure below, you can see how to extract the vertical trace (# 517).

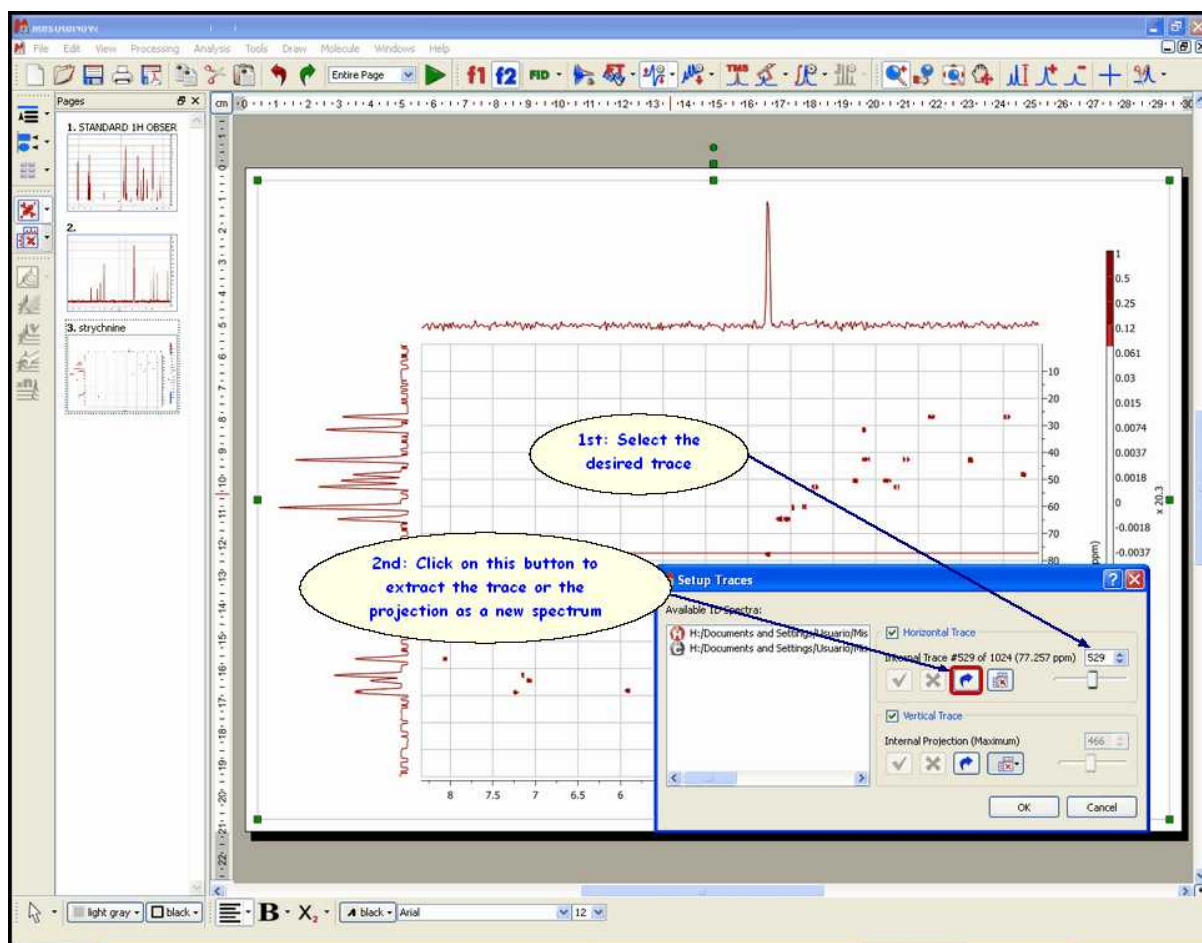

The user will be able to add or remove the 1D traces frame in the 'Scales Properties' dialog box (displayed by double clicking on the 2D-NMR spectral window):

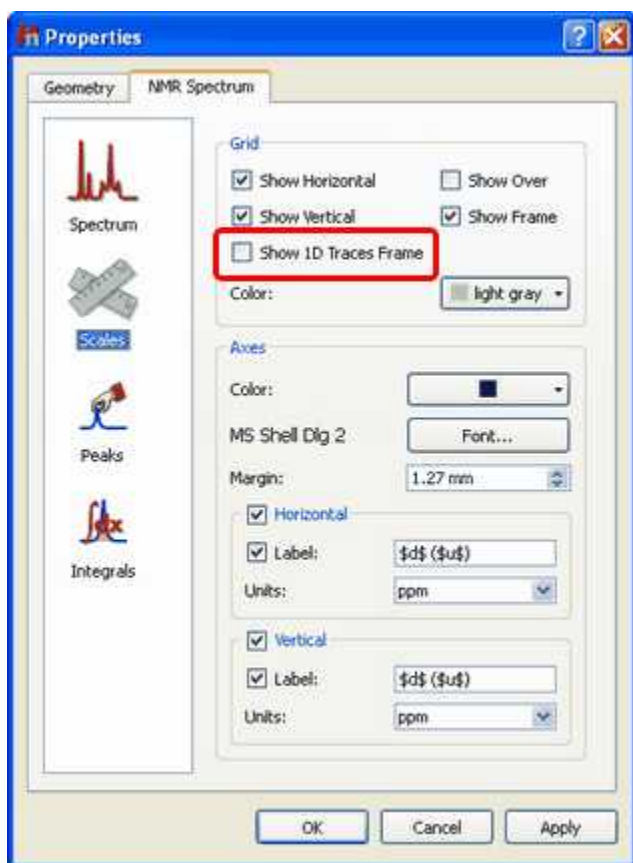

It will be also possible to select the size of the traces or to show them by default, just by selecting the applicable option on the 'Properties' dialog box:

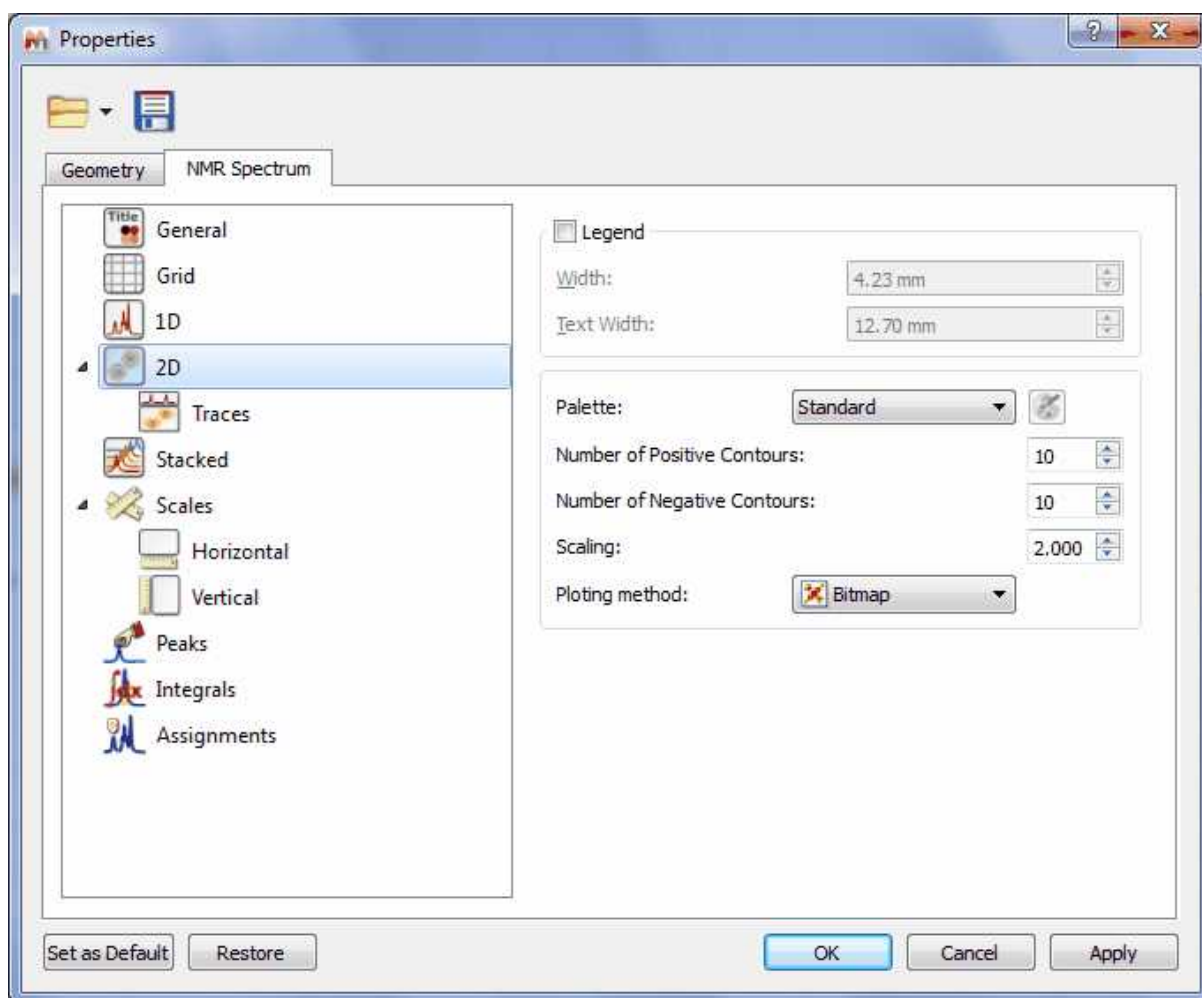

Automatic reference of 2D-NMR spectra with the 1D external trace.

It is now possible to reference the 2D-NMR spectra directly with the 1D external trace. Currently this feature only works with those bidimensional experiments which internal traces are equivalent with the external ones. For example: COSY, NOESY, etc...

Let's see how this feature works with a unreferenced COSY spectrum:

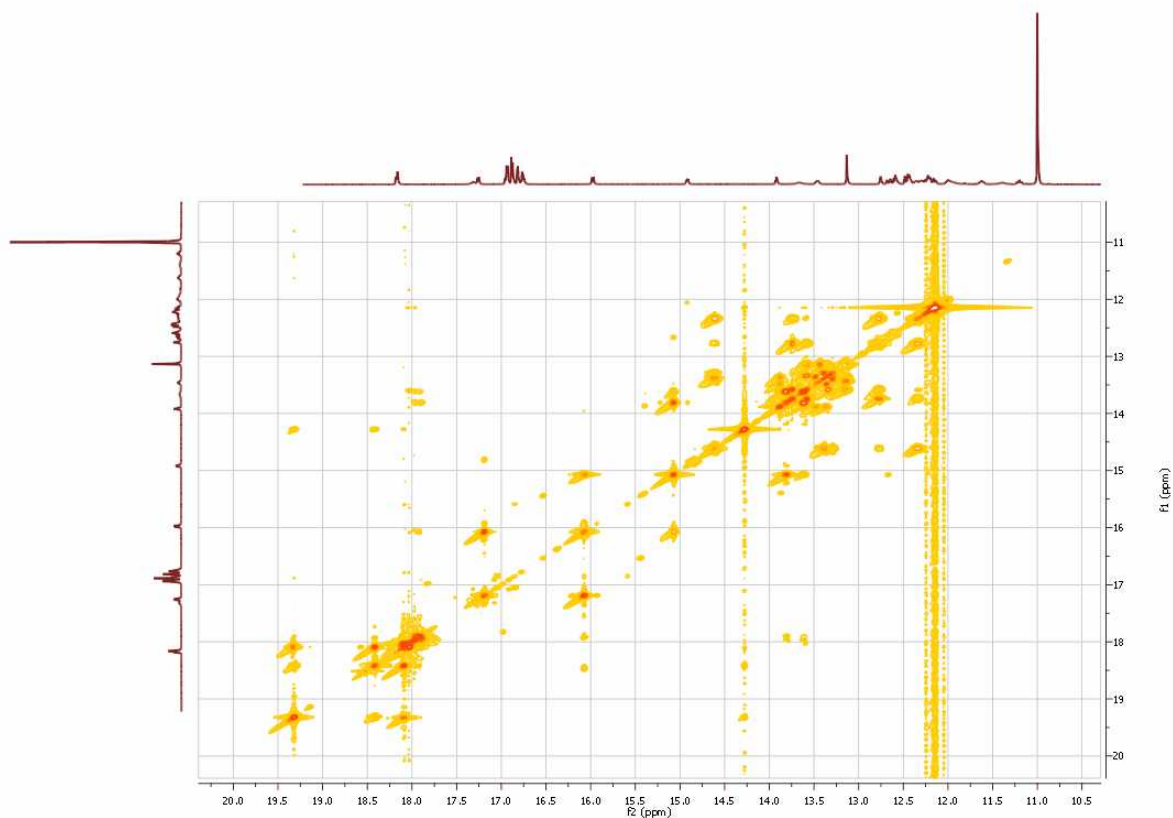

As you can see, this spectrum is not referenced. To apply an automatic referencing, just right click over one of the traces and select 'Setup' to display the 'Setup Traces' dialog box. Once there, select the desired external trace and click on the **AutomaticReference** button (highlighted in red in the picture below):

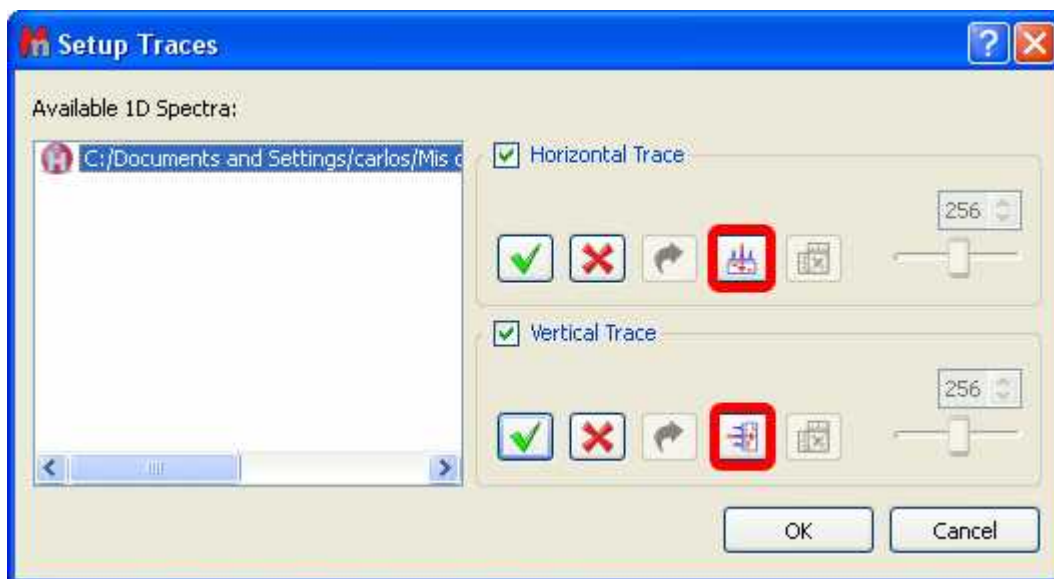

Automatically, you will obtain your COSY spectrum referenced, as you can see in the screenshot

below:

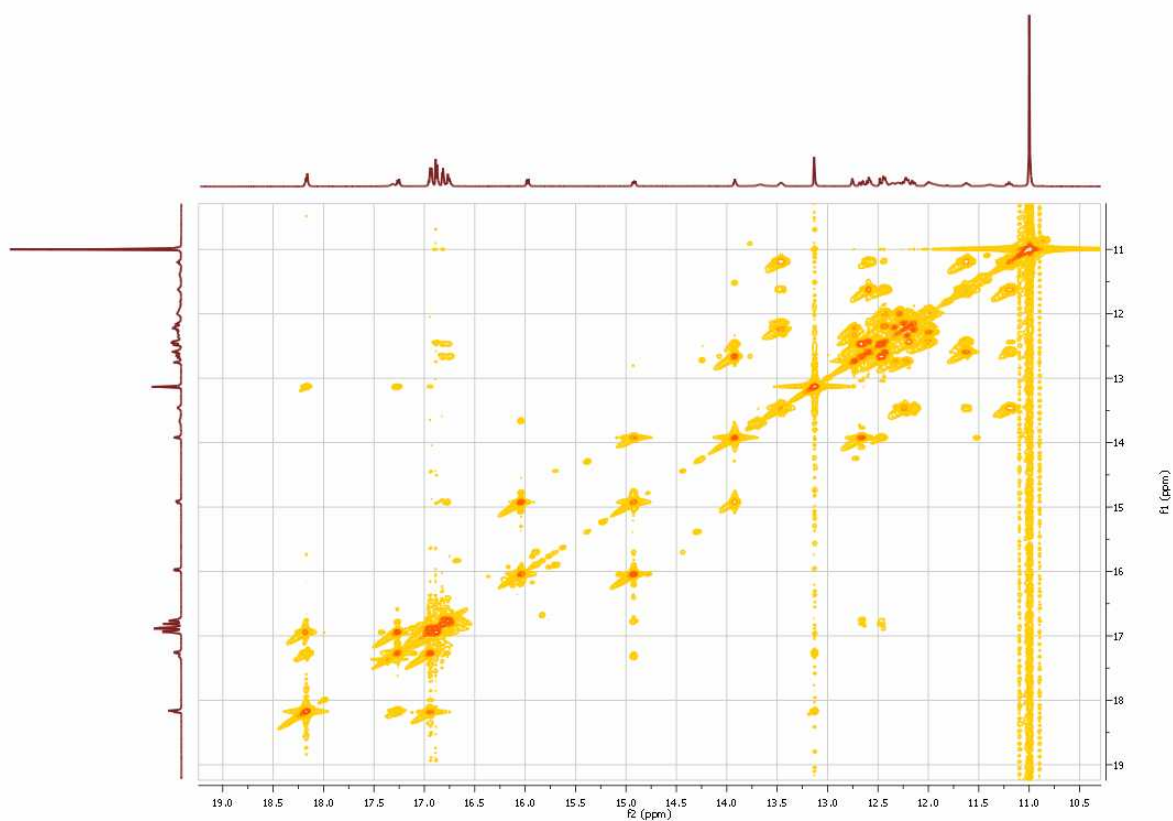

13.7 Manual Phase Correction in 2D-NMR

In this tutorial, we will explain how to phase the spectrum in real time, directly on the 2D spectrum.

We will show how to correct the phase of a gNHSQC experiment (see figure below).

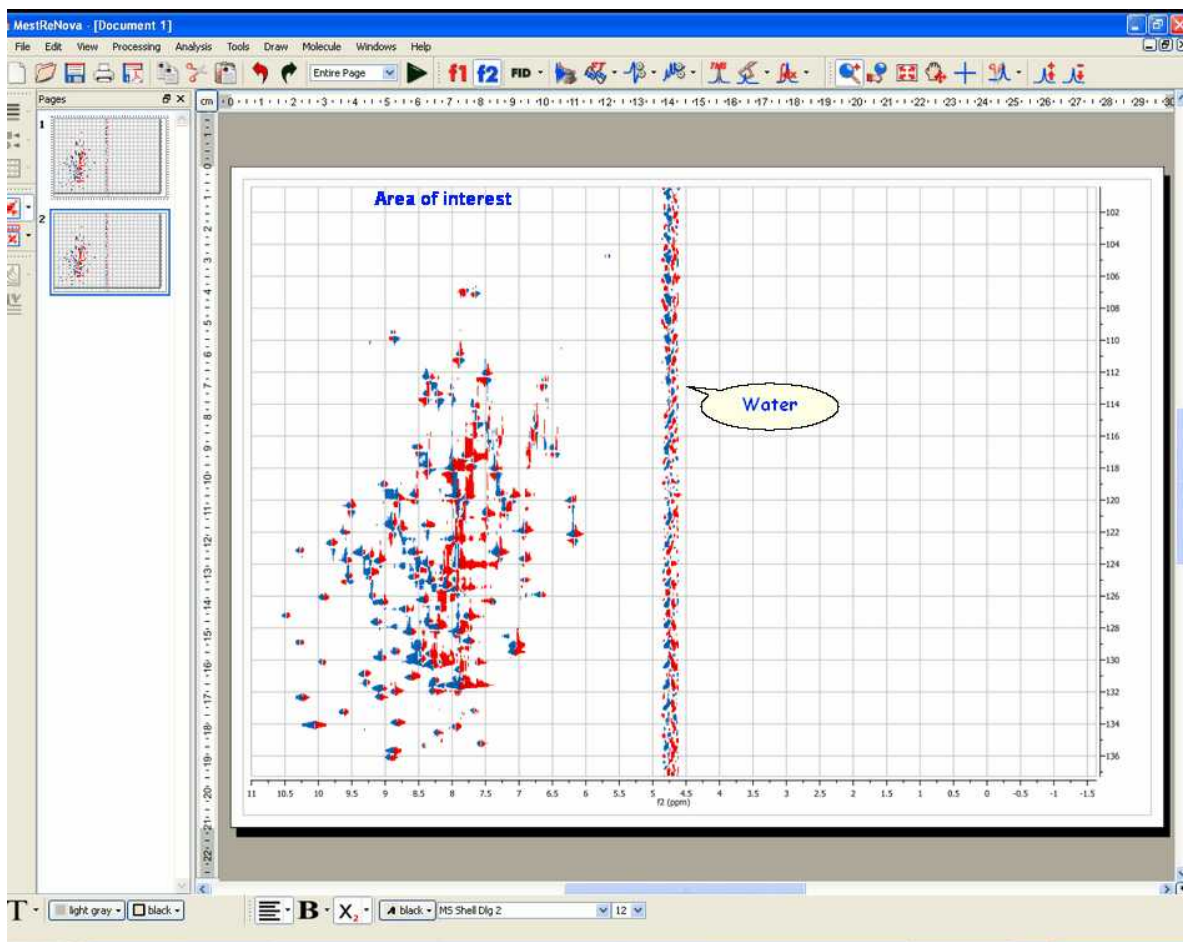

Once you have opened the spectrum; 'zoom in' the area of interest (in this case, we only need to worry about the left half of the spectrum):

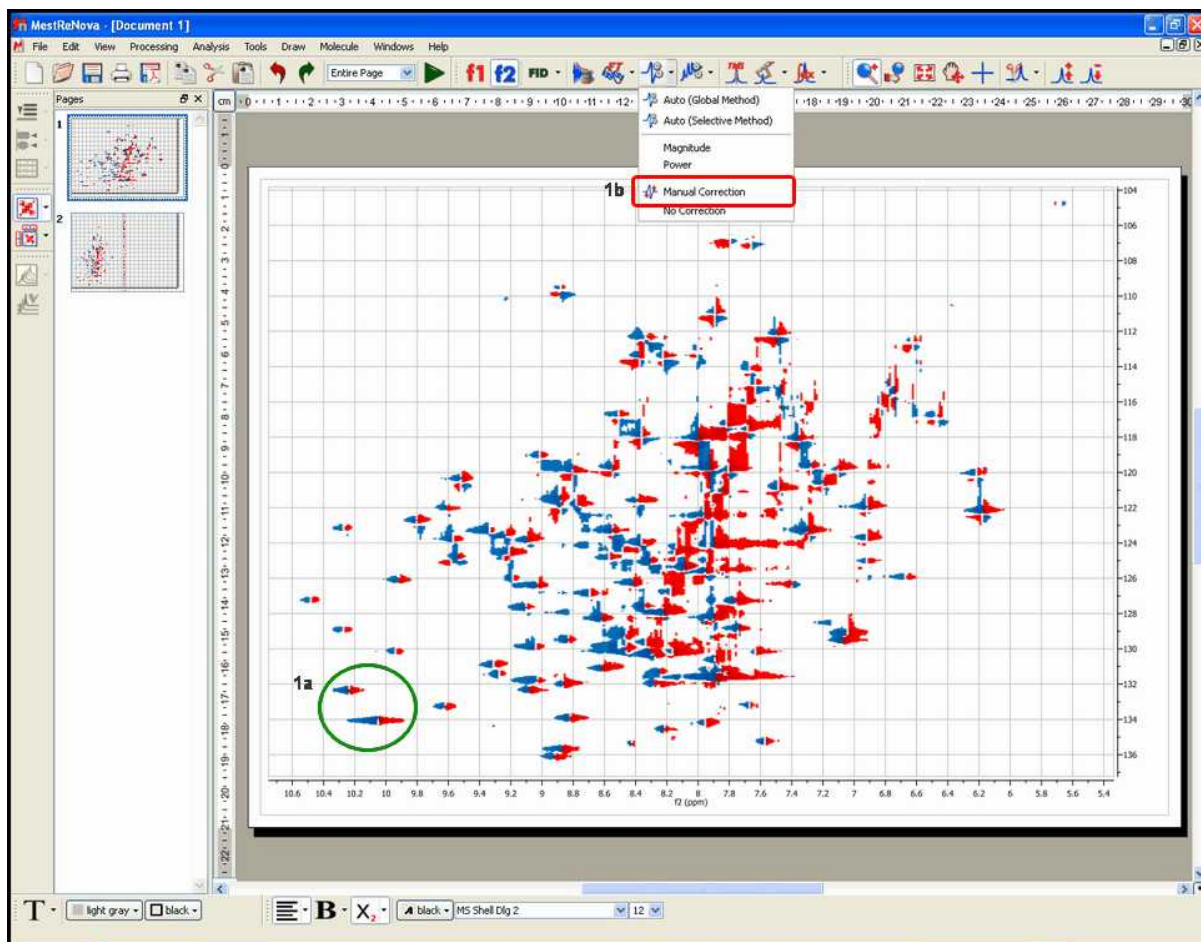

1. Then, take a look at the signal, or the group of signals (**1a**), which appear in a corner of the spectrum (for example, the signals highlighted with a green circle in the capture above); select 'manual correction' (**1b**) from the drop down menu on the 'Phase Correction' toolbar button and adjust the zero order (PH0) phase parameter along f2 (by dragging the mouse up or down over the blue rectangle in the 'Phase Correction dialog box' whilst holding the left mouse button (**1c**)).





Please note that the Phase Correction dialog is **modeless**, so you will be able to use any other tool (i.e. zooming) whilst you are applying the correction.

The goal (**1d**) will be to make all the **signals of the area of interest** (highlighted with the green circle in the picture above) positive (note that in this example, positive signals are red whereas negative are blue). Remember that we are adjusting the phase along f_2 , so do not worry if the phase of the peaks along the indirect (vertical) dimension (f_1) is not correct.

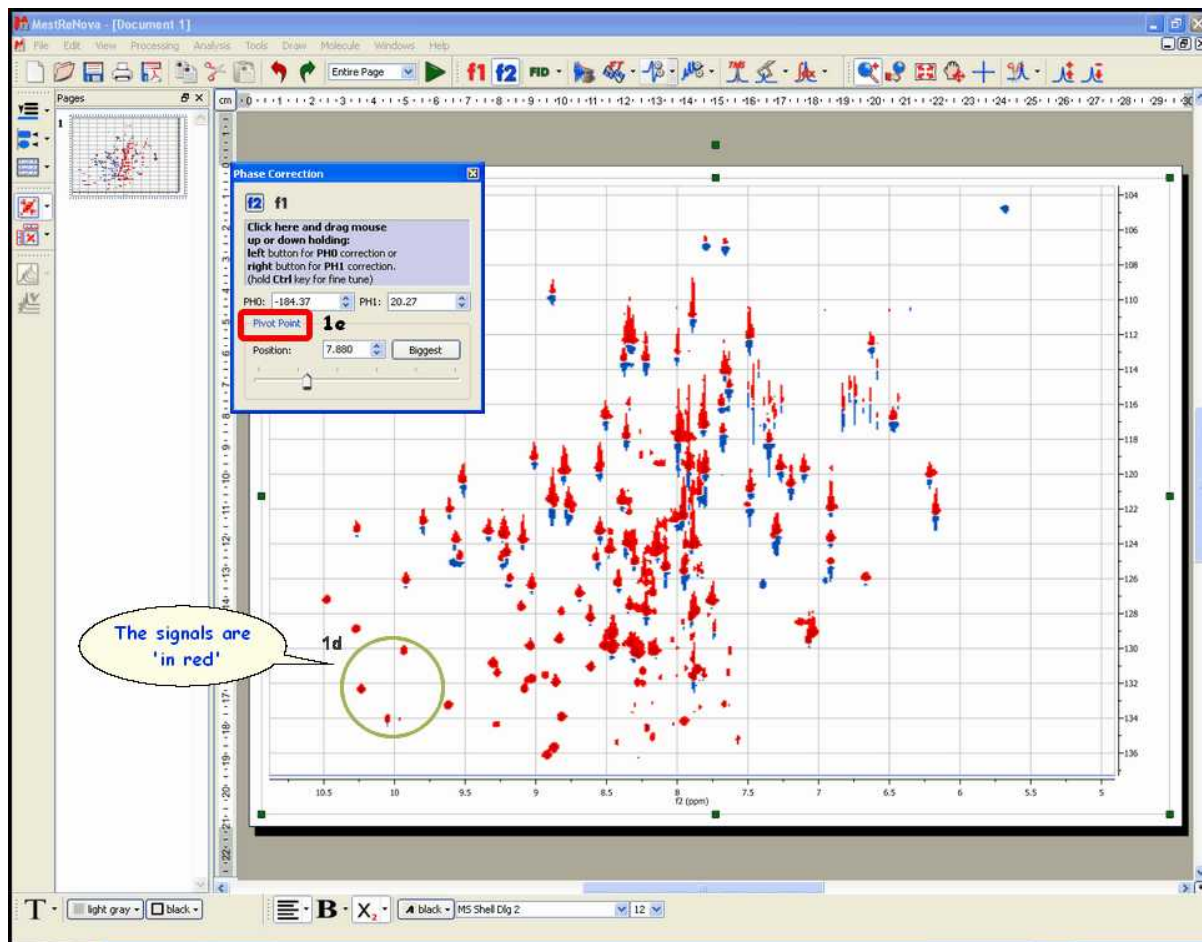

Next, if some peaks on the right side of the area of the spectrum shown on screen require phase correction (remember, still along f_2), you can place the pivot point (**1e**) over the signal we have selected as reference (in the green circle) and carry out the first order phase correction PH1 (by dragging the mouse up or down over the blue rectangle in the 'Phase Correction dialog box' whilst holding the right mouse button). In this particular case, the spectrum does not require first order correction.

2. Finally, if necessary (as in this case), you can proceed in the same manner to correct the phase along f_1 . Just click on the f_1 button on the dialog box and then proceed as explained along f_2 , by starting with a zero order phase correction and following with a first order phase correction (remember: along f_1):

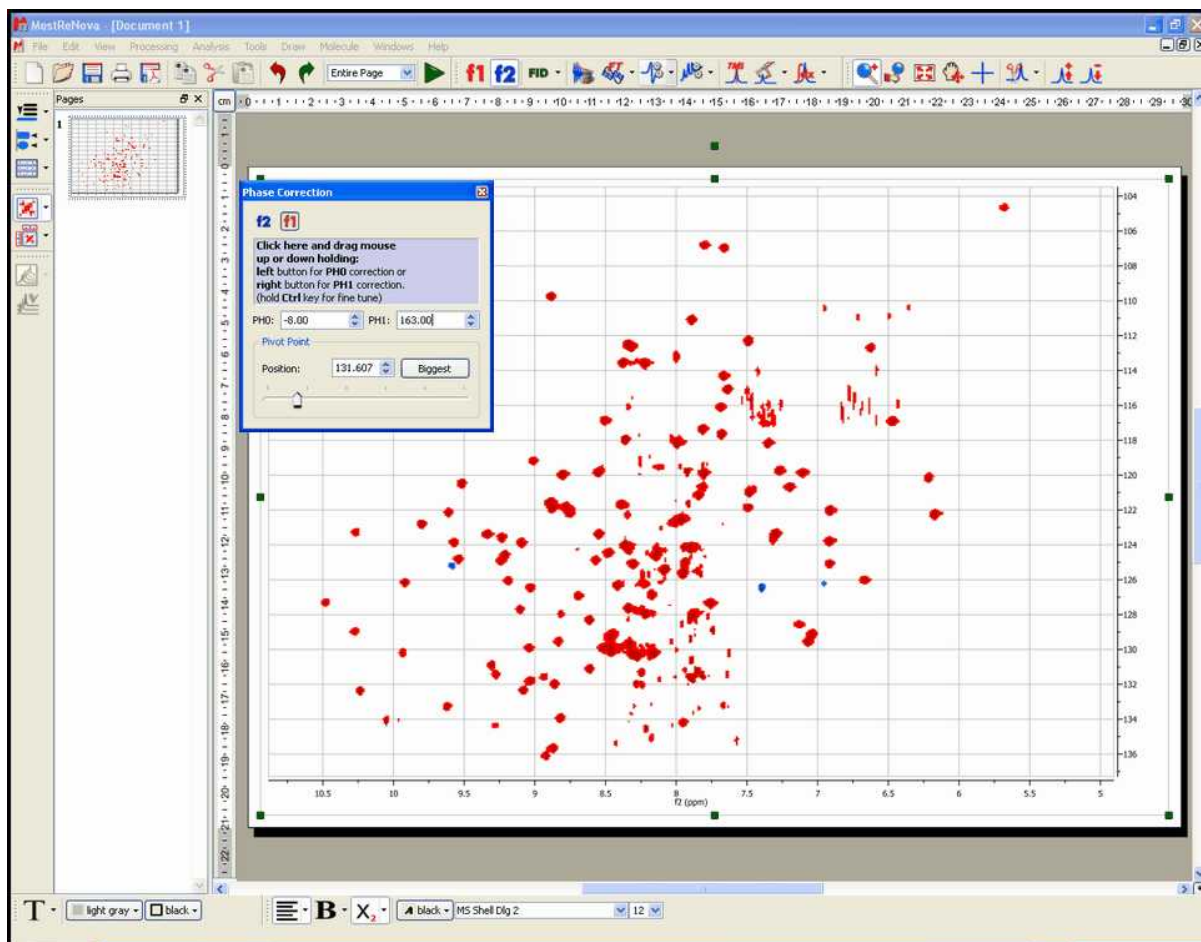

Bear in mind that this procedure is exactly the same as with 1D-NMR spectra, but it is necessary to correct the phase along 2 dimensions.

Note that, in our specific example, the resulting spectrum has 3 negative signals, but this is something that a phase correction is not able to correct.

13.8 Pasting Spectra into Reports

When the user copies a spectrum, he is copying a graphic. A graphic is any kind of image displayed by a computer. There are two kinds of graphics: vector graphics and raster graphics. A vector graphic (metafile) is a graphic drawn as lines, polygons and text while a raster graphic is drawn as an array of colored dots (bitmap).

A **metafile** is a list of commands that can be played back to draw a graphic. Typically, a metafile is made up of commands to draw objects such as lines, polygons and text and commands to control the style of these objects. So, internally, a metafile is an array of variable-length structures called metafile records. The first records in the metafile specify general information such as the resolution of the device on which the picture was created, the dimensions of the picture, and so on. The remaining records, which constitute the bulk of any metafile, correspond to the graphics device interface (GDI) functions required to draw the picture. These records are stored in the metafile after a special metafile device context is created. This metafile device context is then used for all drawing operations required to create the picture. When the system processes a GDI function associated with a metafile, it converts the function into the appropriate data and stores this data in a record appended to the

metafile.

NOTE: Some people equate metafiles with vector graphics. In most cases this is correct but, strictly speaking, a metafile can contain any mix of vector and raster graphics. For example, a metafile could contain just one command to display a bitmap. This is the approach used in Mnova, which by default pastes the spectrum as a metafile which contains a bitmap in order to reduce the file size (without too great a loss in resolution). Mnova also allows the user to use (only in Windows) the graphical format known as **Enhanced Windows Metafiles** in order to keep the maximum graphical resolution possible (at the expense of an increase in the file size). This will usually be the preferred way to copy NMR spectra.

Enhanced metafiles provide true device independence. You can think of the picture stored in an enhanced metafile as a “snapshot” of the video display taken at a particular moment. This “snapshot” maintains its dimensions no matter where it appears—on a printer, a plotter, the desktop, or in the client area of any application.

You can use enhanced metafiles to store a picture created by using the GDI functions (including new path and transformation functions). Because the enhanced metafile format is standardized, pictures which are stored in this format can be copied from one application to another; and, because the pictures are truly device independent, they are guaranteed to maintain their shape and proportions on any output device. In addition, the user is able to work with the copied spectrum in the document just by double clicking on it (Mnova will automatically open due to the Object Linking and Embedding technique; OLE).

A **bitmap** is another name for a raster graphic. In Windows, these are typically saved in a BMP file. However, other common bitmap formats include PC Paintbrush (PCX), Tagged-Image File Format (TIFF), Graphics Interchange Format (GIF) and JPEG.

In general, vector graphics take longer to display but can be scaled to any size with no degradation, whilst raster graphics are faster to display but image quality suffers when they are scaled up or down.

How to paste a spectrum in a Report?

Mnova provides the ability to copy&paste spectra into other applications (e.g. MS Office apps) via the clipboard. Just be sure that you have highlighted the desired objects (Edit/Select All, if you want to select all the objects) and then follow the menu 'Edit/Copy' or alternatively use the shortcut 'Ctrl+C' (or ' ? +C' in Mac). You can also select the page on the page navigator and do Ctrl+C (or right click->Copy) to copy to the clipboard all the content of the page.

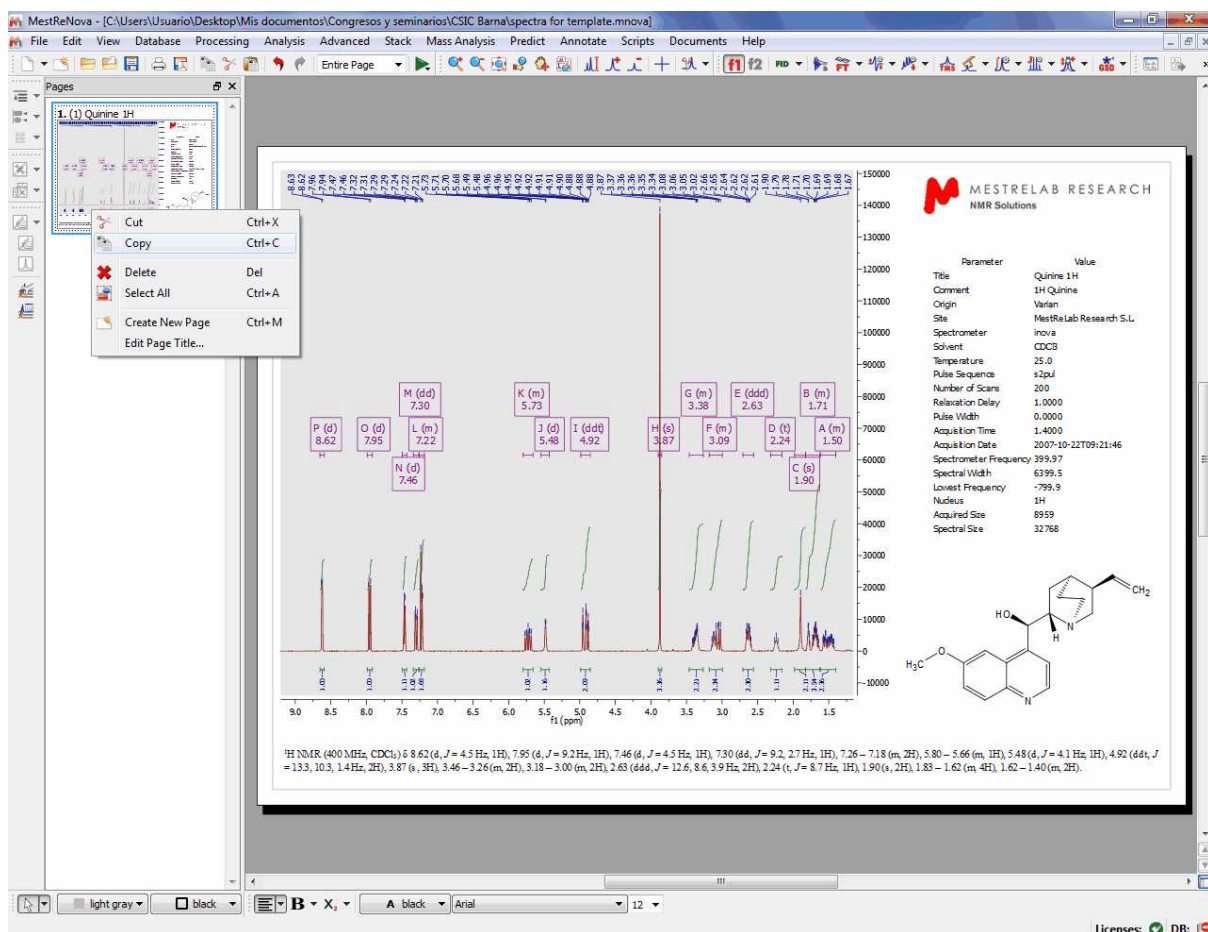

Next, open the document (PowerPoint in this case) where you want to paste the spectrum and follow the menu Edit/Paste or alternatively use the shortcut, Ctrl+V (or ? +V in Mac).

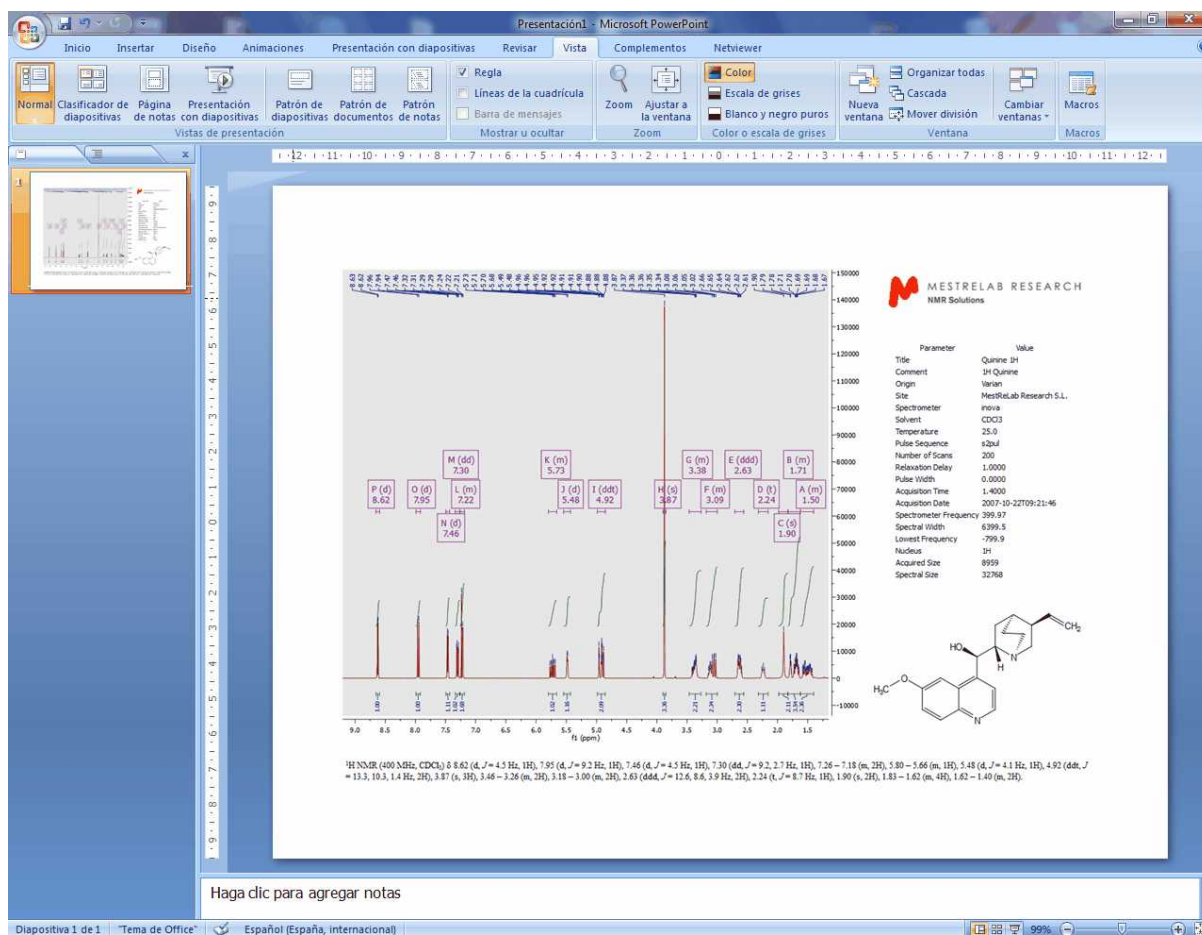

Mnova will copy to the clipboard, by default, the object as a metafile. This object will have OLE properties in Windows, so the user will be able to work with the copied spectrum in the document just by double clicking on it (Mnova will automatically open due to the Object Linking and Embedding technique; OLE). Please bear in mind that the size of this 'image' will be bigger than a regular image, because you are storing the FID to allow Mnova to reprocess the NMR spectrum in the future if it is needed.

However, the user can change this default by following the menu 'Paste/Paste Special' (or Ctrl+Alt+V) before pasting (in the corresponding document; PowerPoint in this case). It will open the 'Paste Special' dialog box where the user will be able to select between Mnova Document (by default), Enhanced Windows Metafile, Bitmap, etc.

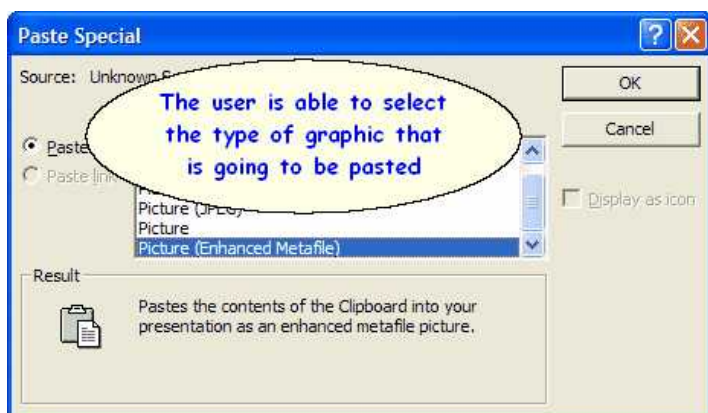

The user can also copy the spectra just as an image (very useful for large datasets) by following the menu 'Edit/Copy Special/Copy as an image'. **This will reduce the file size of the document but the image will not contain OLE properties.**

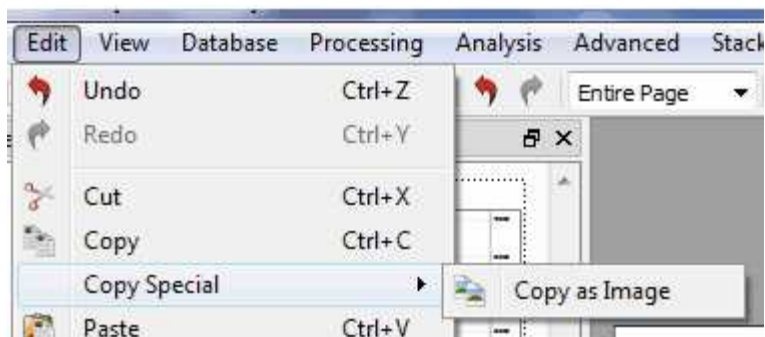

From the '**Drawing Tools Preferences**', you will be able to select the exporting 'Resolution' and 'Quality' of the graphics and also the resolution of the image copying:

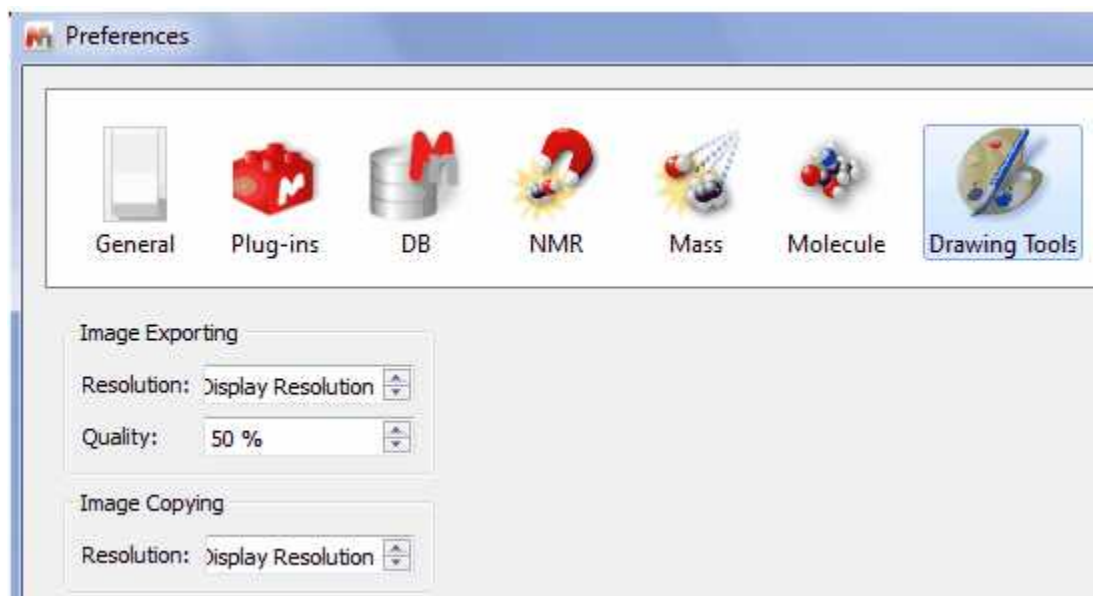

The user can also save the spectrum by following the menu 'File/Save as' and then 'paste it' in the corresponding document by selecting 'Insert/Picture'. Mnova allows the user to save the data in Mnova

(*Mnova) or MestRe-C (*.mrc) formats as well as in ASCII text (*.txt), adobe PDF or several kinds of image files, such as bitmap (bmp), enhanced metafile (emf), JPEG, PNG, PostScript, SVG, TIFF, XBM, XPM, etc...

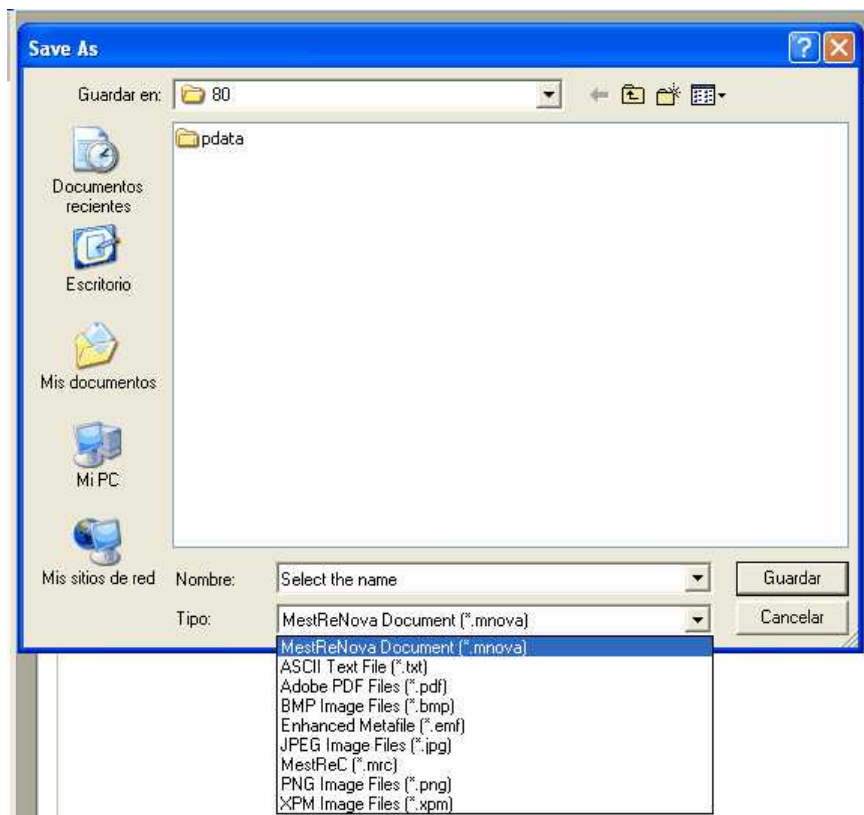

'ASCII Text File' (*.txt): It is essentially raw text just like the words you are reading now. Each byte in the file contains one character which conforms to the standard ASCII code. This kind of text file becomes a common denominator between applications which do not import each other's formats. If both applications can import and export ASCII files, you can transfer your files between them. Almost all word processors import and export ASCII files as well as many database and spreadsheet programs.

'Adobe Text File' (*.pdf): Portable Document Format (PDF), is an open file format used for representing two-dimensional documents in a device independent and resolution independent fixed-layout document format. Each PDF file encapsulates a complete description of a 2D document which includes the text, fonts, images, and 2D vector graphics which compose the document.

'JPEG Image File' (*.jpg): JPEG stands for Joint Photographic Experts Group; it is a lossy compression algorithm which has been conceived to reduce the file size of natural, photograph-like true-colour images as much as possible without affecting the quality of the image as perceived by the human sensory engine.

'PNG Image File' (*.png): PNG (Portable Network Graphics) is another bitmapped image format which employs lossless data compression.

XPM Image Files (*.xpm): XPM stores image data in the form of ASCII text formatted as a Standard C character string array. This type of format allows XPM files to be edited easily with any text editor, to have comments inserted at any point within the file, to be included as data in C and C++ programs,

and to be easily transmitted via electronic mail.

13.9 How to predict a spectrum with NMRPredict Desktop?

Carrying out of predictions in Mnova with the **NMRPredict Desktop** plugin is very easy and intuitive.

1. Just, import a molecular structure. Currently, molecular structures can be imported as a **.mol** file by simply using the Open command exactly in the same way as this would be applied to a spectrum. Bear in mind, that you are actually able to copy&paste **.cdx** structures from **ChemDraw** and **.mol** from **IsisDraw** but not drag&drop them. Support to 'drag & drop' operations are currently limited to **ChemSketch**.



ATTENTION

Bear in mind that, in terms of stereochemistry, drawing a structure as a chair or as a boat means nothing to the **.mol** file and the computer. In those cases the user must draw all the corresponding bonds to show the stereochemistry of the molecule, i.e., you must explicitly draw up and down bonds using wedges.

2. Right click on the molecule structure and select 'Predict 1H Spectrum' or 'Predict 13C Spectrum'.

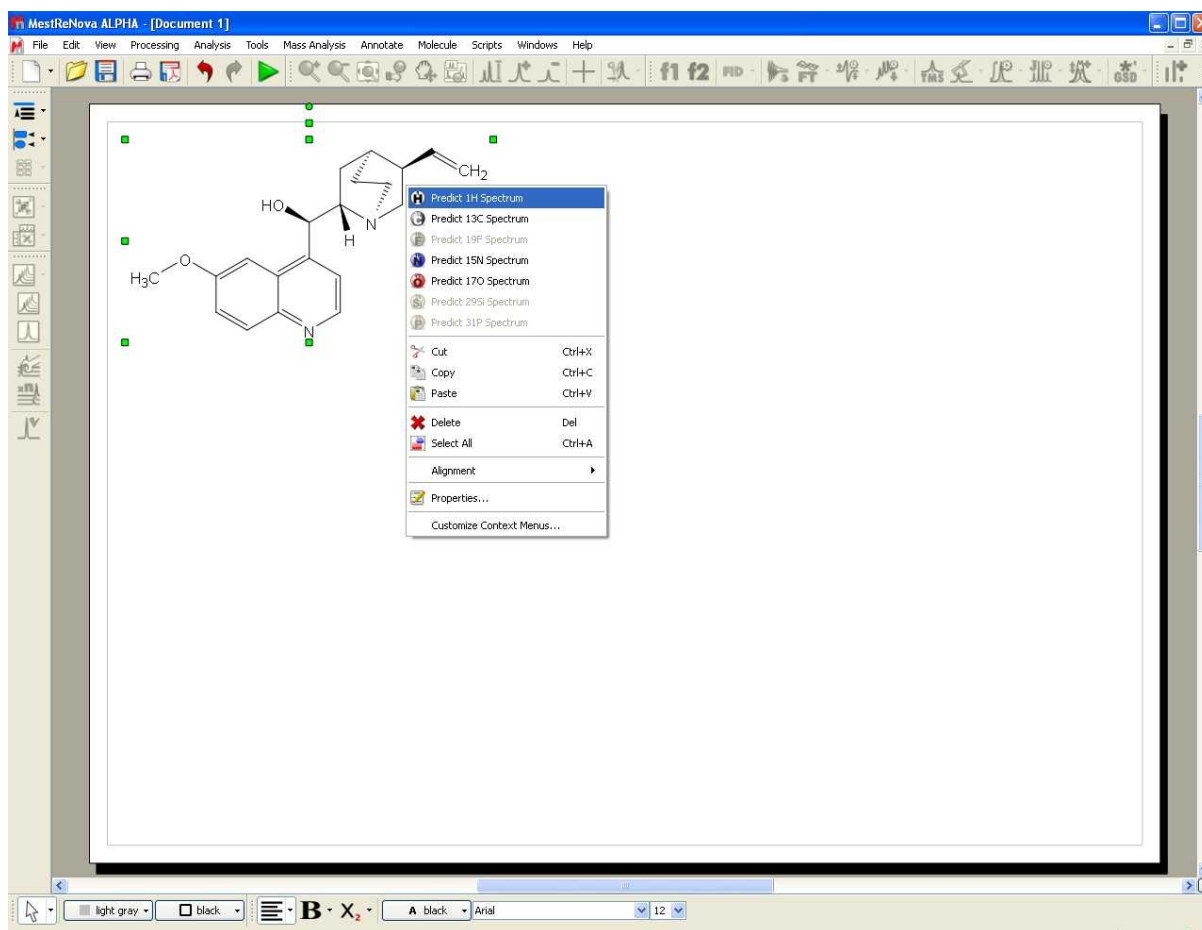

3. After that, you will obtain the desired predicted spectrum which can be analyzed as a real one (e.g. it

can be integrated, peak picking, etc).

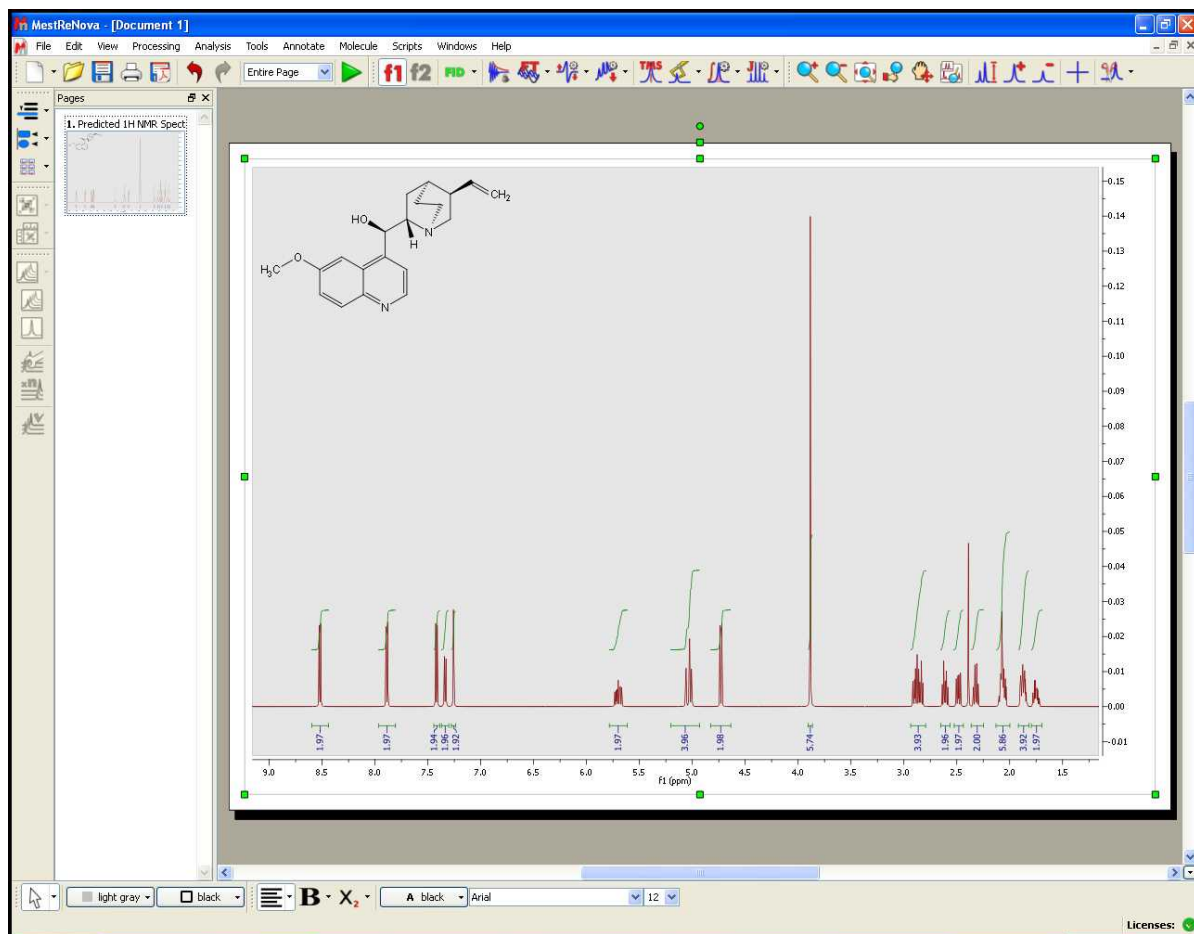

You can also modify the chemical shift and the coupling constant values from the table of the predicted spectrum. Just, highlighted the spectrum, follow the menu 'View/Table/1HPrediction' and then double click on the value that you want to edit. The changes made on the table will take effect automatically in the simulated spectrum.

Please bear in mind that the peak labels and the multiplet boxes will show the corresponding atom numbers of the molecule.

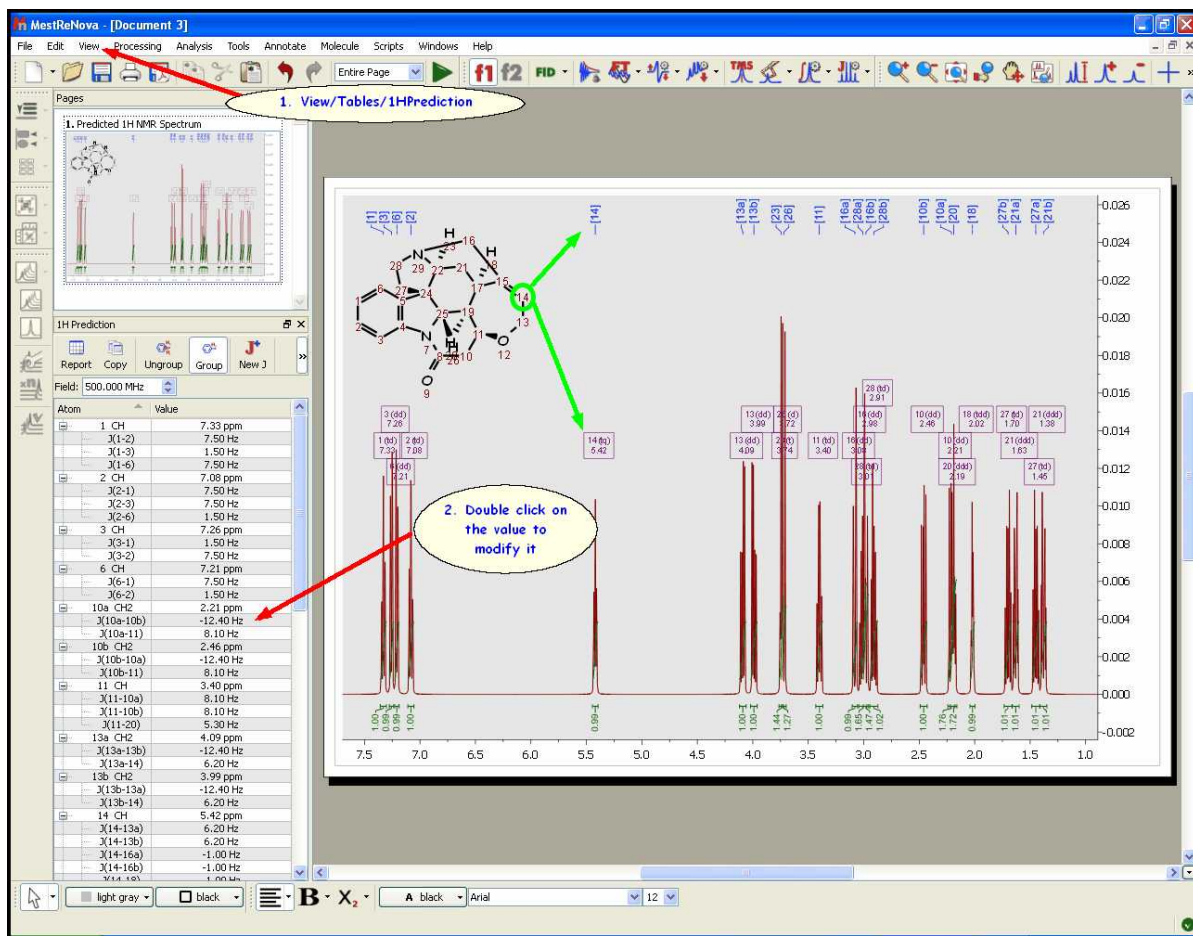

Finally, if you want to know the "predicted assignment", just hover the mouse over the desired atom, (so that it becomes highlighted in a red box) and the corresponding signal in the spectrum will automatically highlight in blue (increasing slightly its intensity); or vice versa (hovering the mouse over the peak will highlight the corresponding atom on the molecular structure).

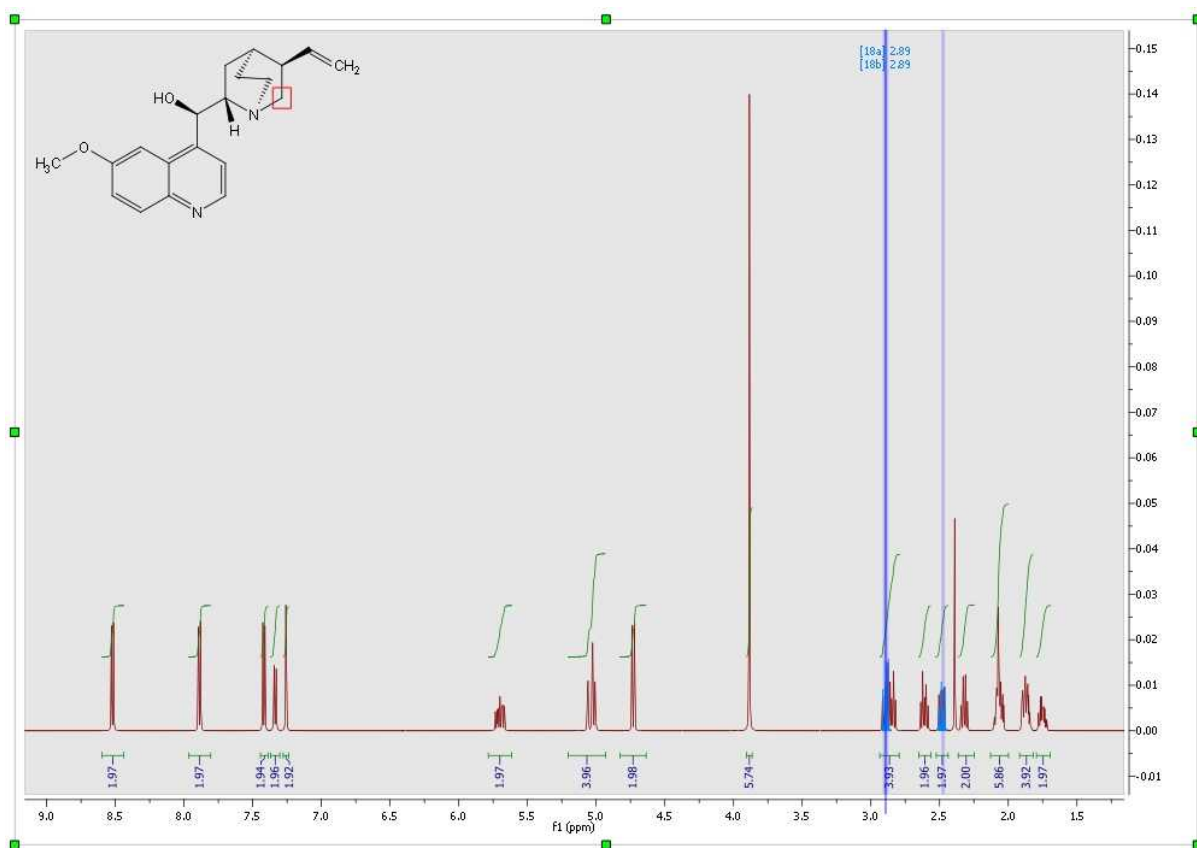

A similar procedure will be followed to run X-Nuclei predictions: ^{31}P , ^{19}F , ^{15}N , ^{17}O , ^{29}Si . In this case, just follow the menu 'Predict' and select the desired option:

-  Predict ^{15}N Spectrum
-  Predict ^{17}O Spectrum
-  Predict ^{19}F Spectrum
-  Predict ^{29}Si Spectrum
-  Predict ^{31}P Spectrum

Of course you will be able to change the appearance of your simulated spectra as you prefer. Here is a sample:

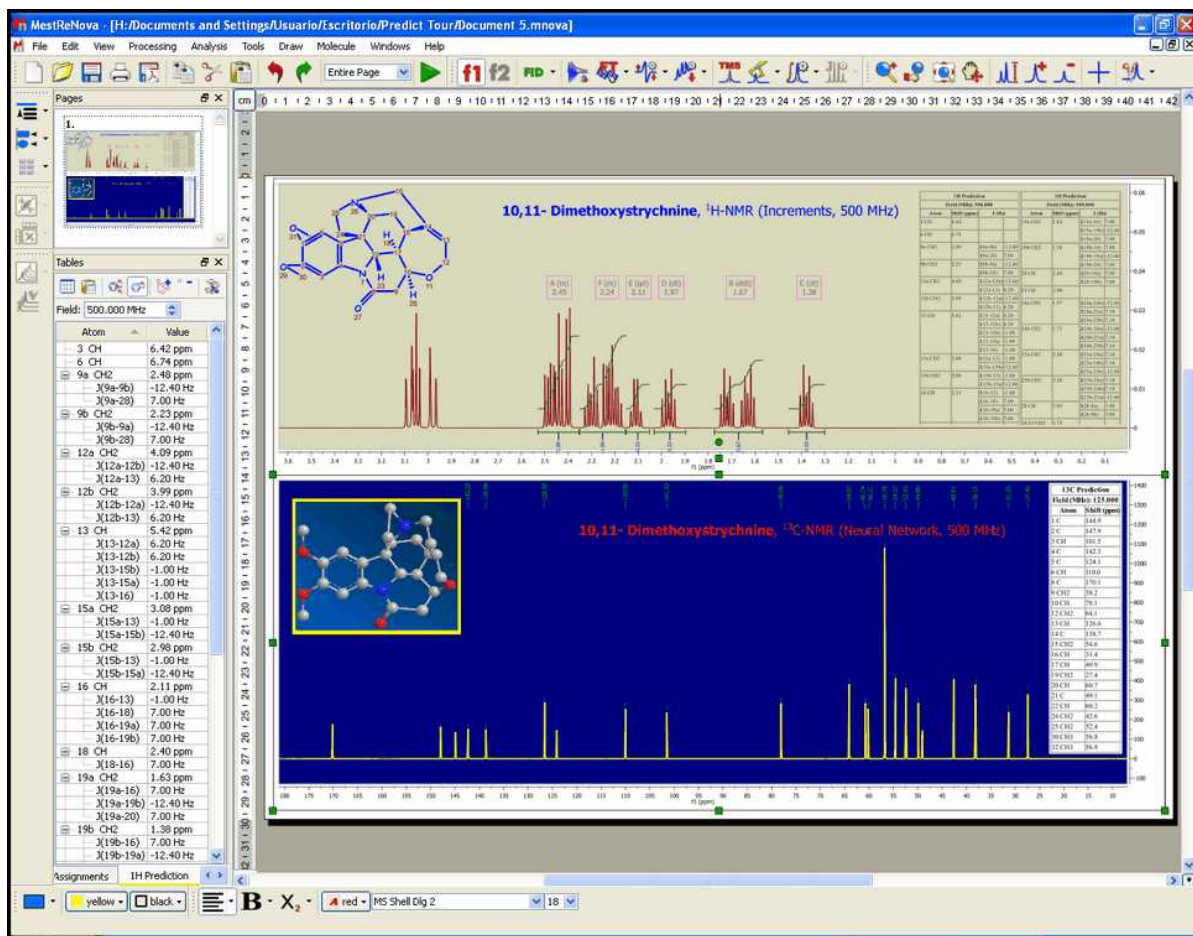

Part



14 Mass Plugin

Mnova incorporates a new plugin to process LC/GC chromatograms and mass spectra. The concept behind the multiplatform, multipage Graphical User Interface of Mnova is to allow the average chemist easy access to high quality processing and analysis of analytical data on the desktop computer and OS of choice. The new Mnova MS plugin gives the chemist the ability to work with LC/GC/MS data in combination with NMR data, within a single document.

Following the Mnova concept, seamlessly interact with and handle data from different vendors. HP Agilent (ChemStation, Ion trap, MassHunter), Thermo Scientific–Xcalibur, Waters MassLynx, Bruker (Compass, XMass), JEOL MSQ1000, SCIEX Analyst, Shimadzu, NetCDF ANDI-MS. mzData and mzXML are all supported by the second release version. It provides a graphical user interface (GUI) for interaction with and display of dataset contents and tools and algorithms for basic processing of chromatograms and mass spectra.



Please bear in mind that to open Bruker Compass MS spectra, you will need to have installed the Bruker Compass libraries (CompassXtract_3.1.3.exe) into your computer. You can get them for free by using this [link](#) after having registered. Finally, re-install Mnova making sure that you check Bruker component for the Mass plugin:

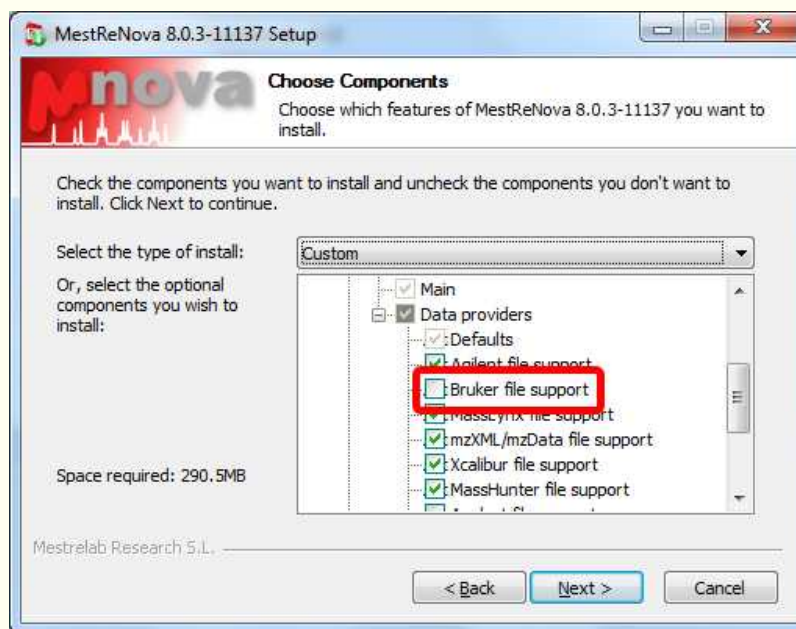

To display SCIEX Analyst experiments, you will need to have installed the 'Analyst QS' software, which you can download from [here](#).

Please bear in mind that Mnova MS under Mac and Linux only supports:

- Agilent – ChemStation
- Bruker – XMass
- FSU – Midas
- mzData and mzXML

- Waters – MassLynx (Mac only)

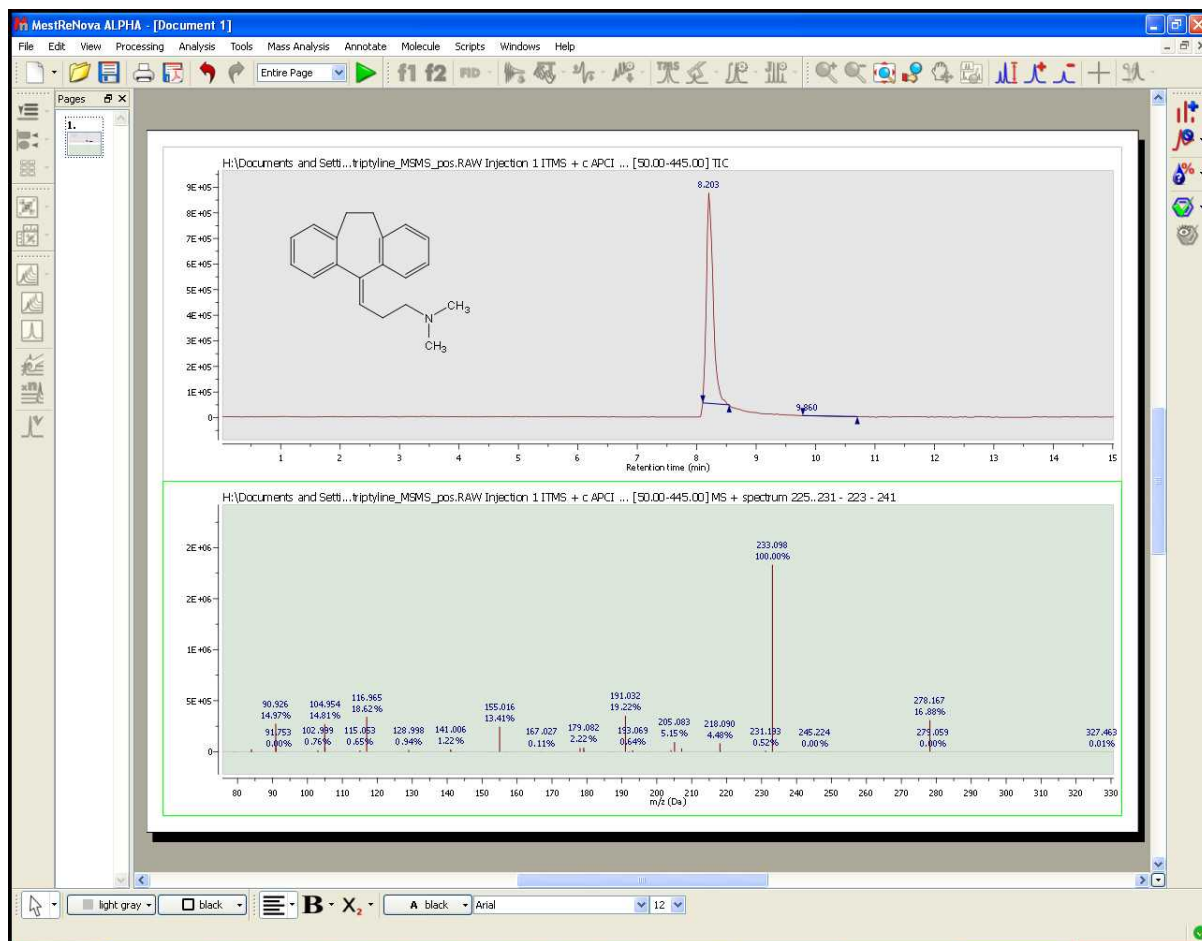

The target user for the first version of the MS plug-in is one whose goals are the elucidation and confirmation of small molecule structures.

The Mnova framework will allow the user to combine the results of multiple analyses into a consolidated report of results.

You will find below a glossary of the main terms relating to the MS plugin:

- **Adduct:** Ion formed by the interaction of an ion with one or more atoms or molecules to form an ion containing all the constituent atoms of the precursor ion as well as the additional atoms from the associated atoms or molecules.
- **Accurate Mass:** Experimentally determined mass of an ion that is used to determine an elemental formula. Typically, a mass accuracy of 5 ppm or better, at relatively low m/z values, is necessary to compute a correct elemental formula. See the section on elemental composition later in this document.
- **Base Peak:** The most intense peak of the mass spectrum which is assigned a relative abundance value of 100 percent. The lesser peaks are reported as a fraction of the base peak abundance.
- **Chemical ionization (CI):** Formation of an ion in the gas phase by the reaction of a neutral species with an ion. The process may involve transfer of an electron, a proton or other charged species between the reactants. Note: When a positive ion results from chemical ionization the term may be used without qualification. When a negative ion results the term negative ion chemical ionization

should be used.

- **Electron Ionization (EI):** Ionization of an atom or molecule by electrons that are typically accelerated to energies between 10 and 150 eV in order to remove one or more electrons from the molecule. The term electron impact is deprecated.
- **Electrospray Ionization (ESI):** A process in which ionized species in the gas phase are produced from a solution via highly charged fine droplets, by means of spraying the solution from a narrow-bore needle tip at atmospheric pressure in the presence of a high electric field (1,000 to 10,000 V potential).
- **Fast Atom Bombardment (FAB):** A method in which ions are produced in a mass spectrometer from non-volatile or thermally fragile organic molecules by bombarding the compound in the condensed phase with energy-rich neutral particles.
- **Isotope Cluster:** Set of mass peaks related to ions with the same chemical formula but containing different isotopes; e.g. the 16 and 17 Da peaks in a CH₄ sample arising from ¹²CH₄⁺ and ¹³CH₄⁺ ions.
- **Mass Spectrometry/Mass Spectrometry (MS/MS):** The acquisition and study of the spectra of the electrically charged products or precursors of m/z selected ion or ions, or of precursor ions of a selected neutral mass loss. MS/MS can be accomplished using beam instruments incorporating more than one analyzer (tandem mass spectrometry in space) or in trap instruments (tandem mass spectrometry in time).
- **Mass Spectrum:** A plot of the relative abundances of ions as a function of their m/z (mass to charge ratio) values, representing data produced by a mass spectrometer.
- **Mass Resolution:** In a mass spectrum, the smallest mass difference (Δm) between two equal magnitude mass peaks such that the valley between them is a specified fraction of the peak height. Typically, a 10% valley is specified, or 50%, which is known as full width at half-maximum height (FWHM).
- **Mass Resolving Power:** In a mass spectrum, the observed mass divided by the difference between two masses that can be separated: $m/\Delta m$.
- **Mass Chromatogram:** A chromatogram obtained from the plot of the intensity of a single m/z value or of a range of m/z values for each mass spectra in a dataset versus time.
- **Molecular Isotope Cluster Chromatogram (MICC):** The MICC is the sum of the mass chromatograms of each m/z value of an isotope cluster.
- **Total Ion Chromatogram (TIC):** The chromatogram obtained from the plot of the sum of intensities for each mass spectrum in a dataset versus time.

14.1 First Steps with the Mass Plugin

It is very easy to obtain your first results with the Mass plugin of Mnova:

1. Drag&drop the raw folder to Mnova in order to display the TIC (at the top of the window) and the MS spectrum of the highest signal.

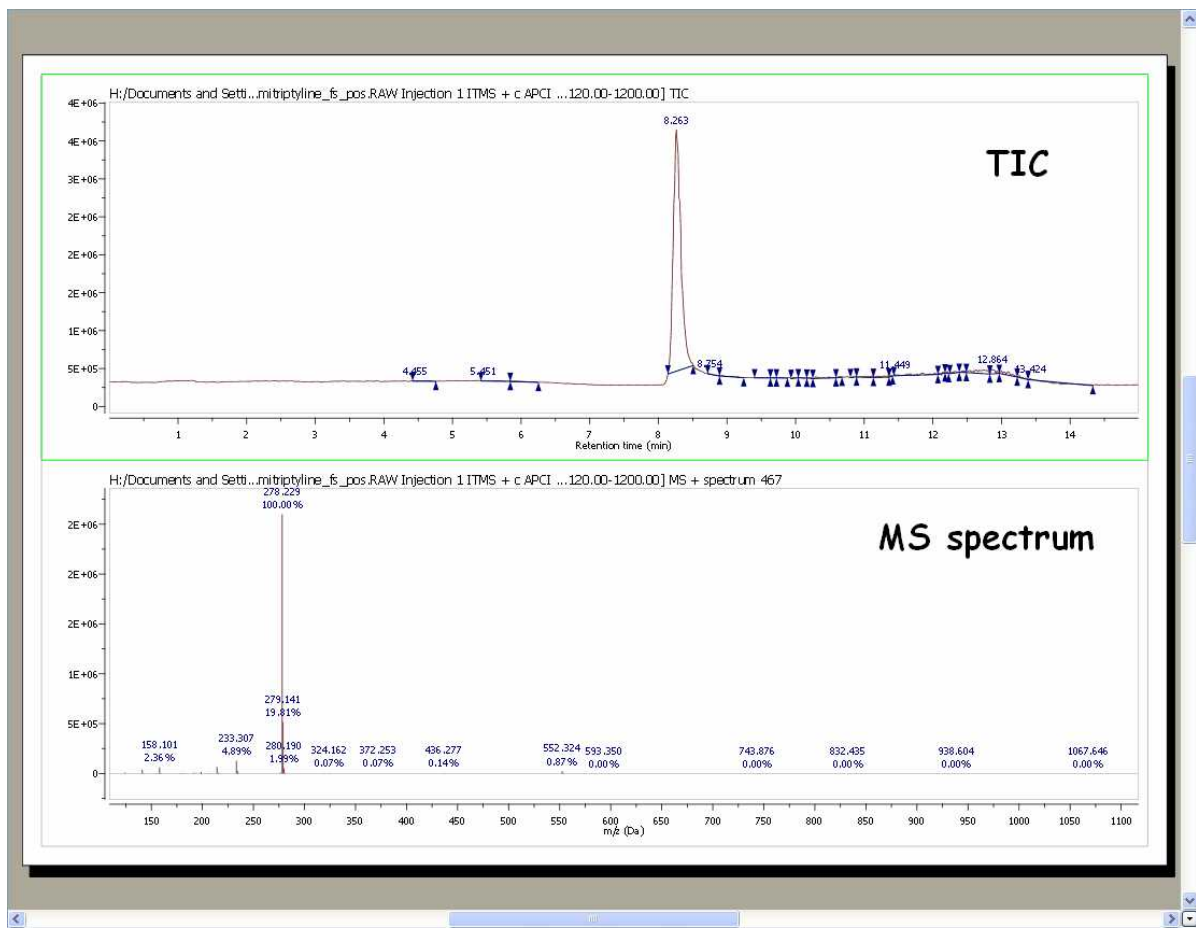

2. You can expand any scale (in either the TIC or MS) by using the 'zoom in' feature, which can be accessed by just pressing the 'Z' key or by using the corresponding icon of the toolbar .

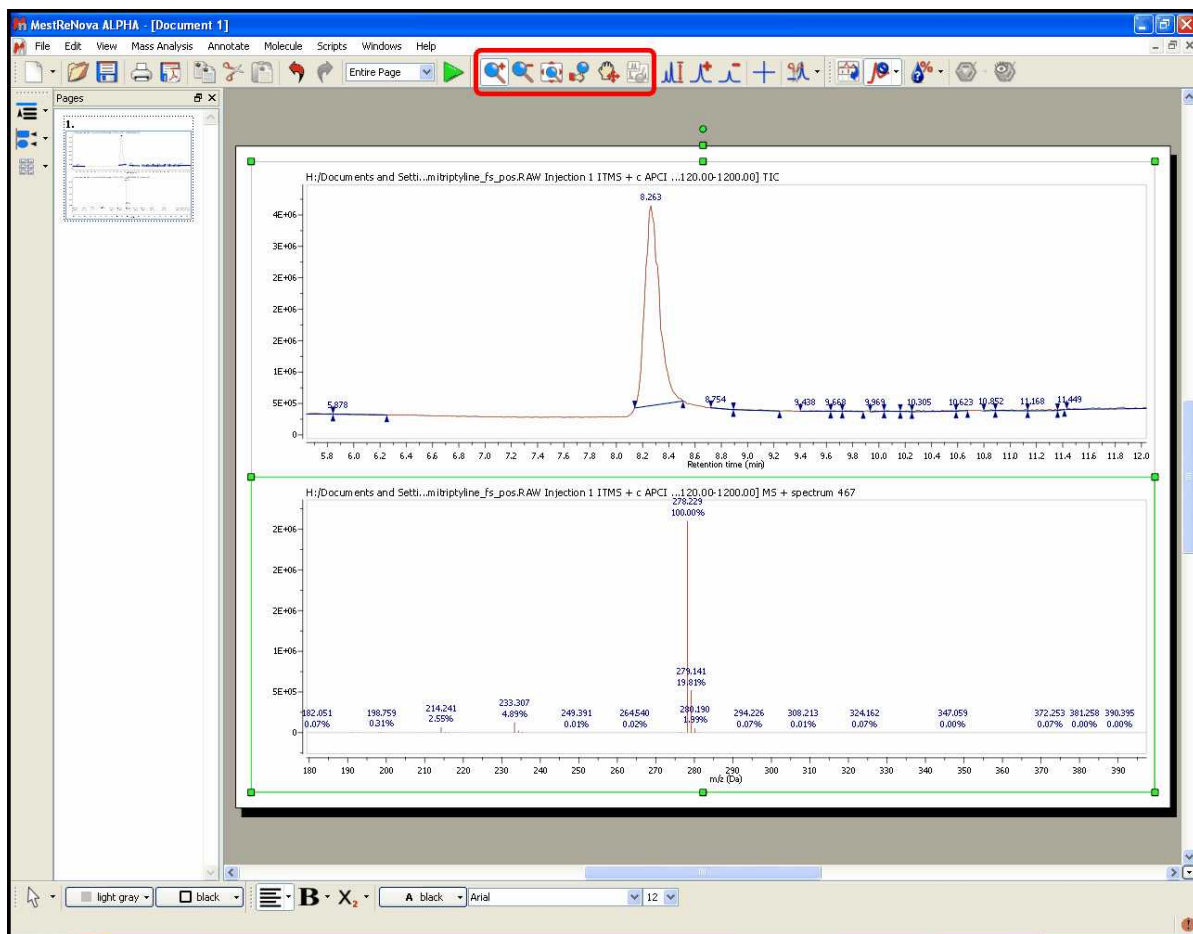

3. You can select any other mass spectrum for a particular time point with the crosshair feature  just by clicking on the corresponding signal of the TIC. For example in this case, we have selected the spectrum number 467 at a 'Retention time' of 8.26 min:

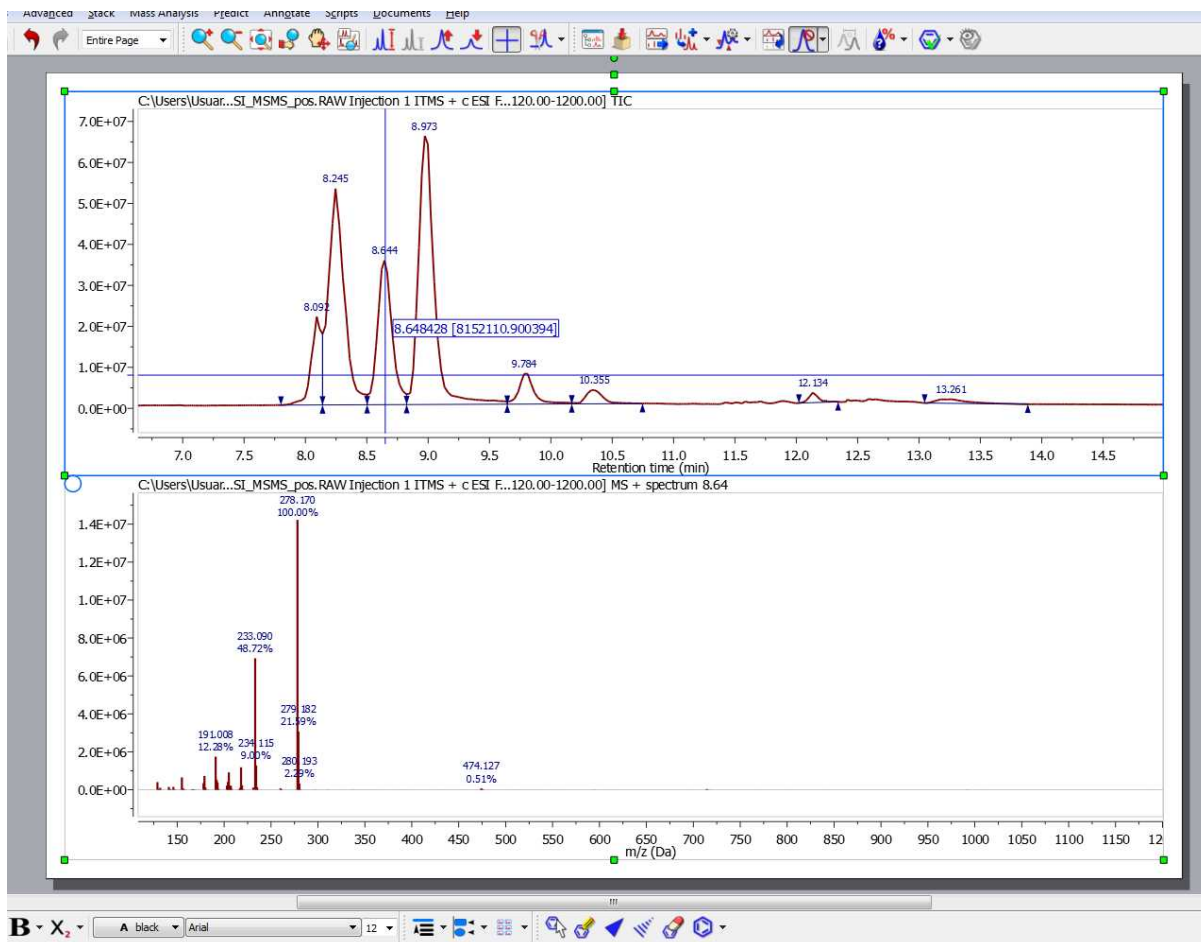

4. If you need to average the mass spectra over a certain time range (CoAdd), just select the crosshair, hold down the left mouse button and drag over the appropriate time span in the TIC. A label at the top of the MS will inform you about the spectrum ranges (red rectangle in the picture below):

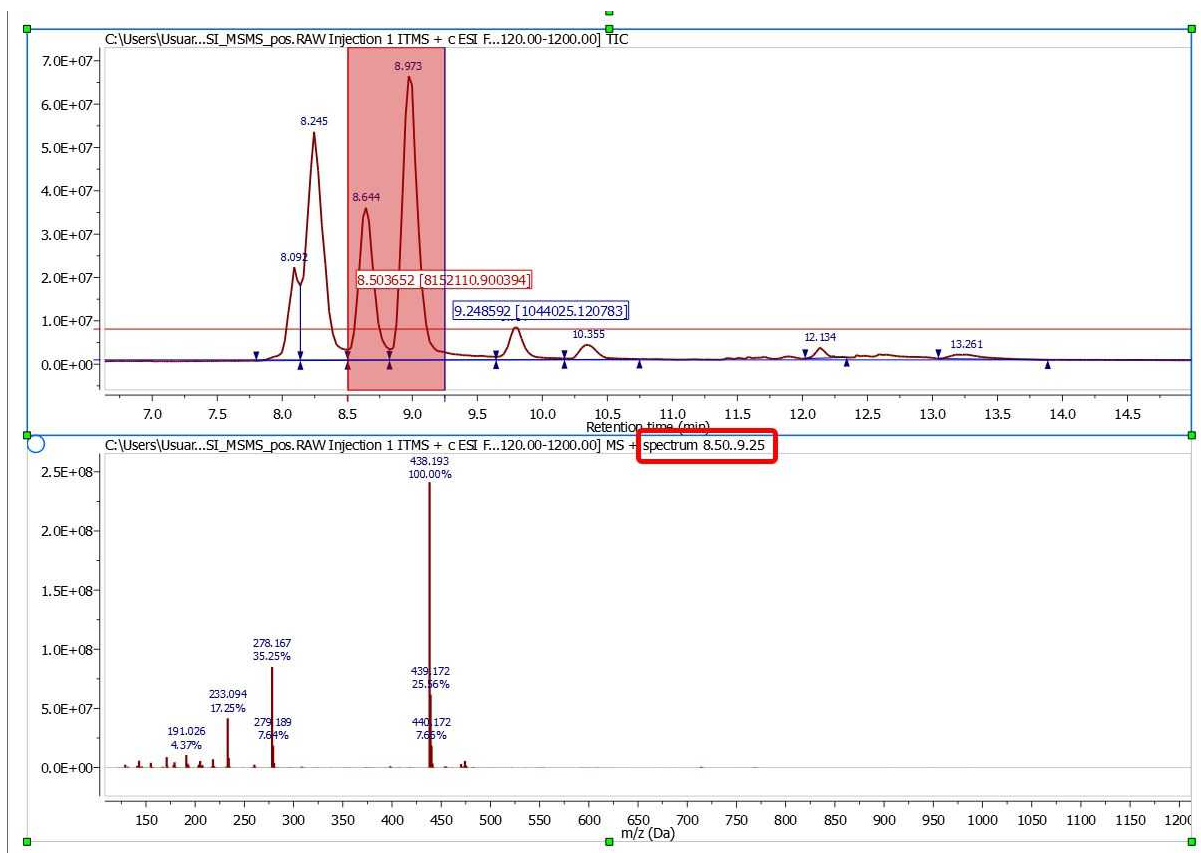

If you want to 'CoAdd' the whole peak, just follow the menu 'Mass Analysis/Spectrum Selection Mode/Peak' and finally select the desired peak in the TIC.

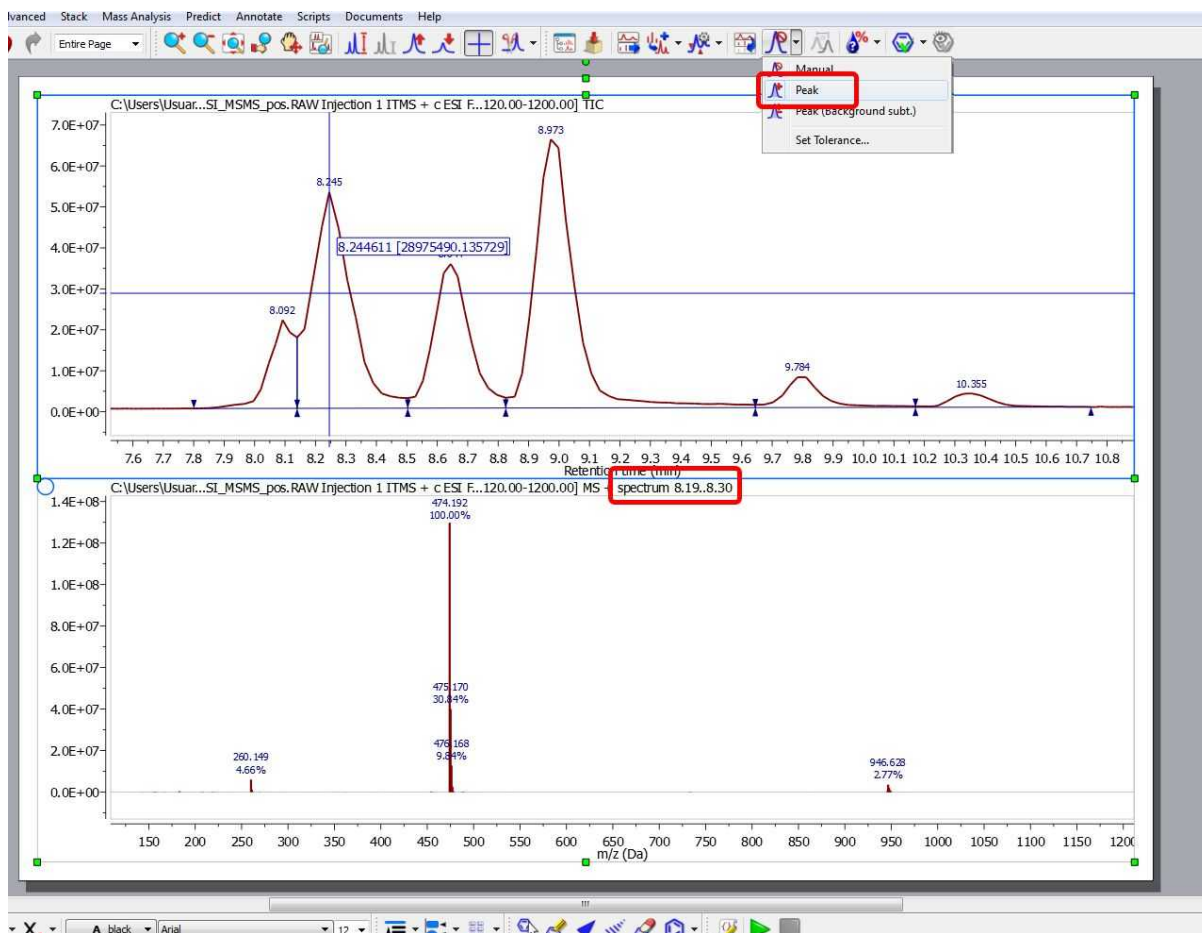

To generate a 'CoAdd' of the whole peak without the tail-peaks just select the mode 'Peak (Background Subt.)' under the 'Mass Analysis/Spectrum Selection Mode' menu.

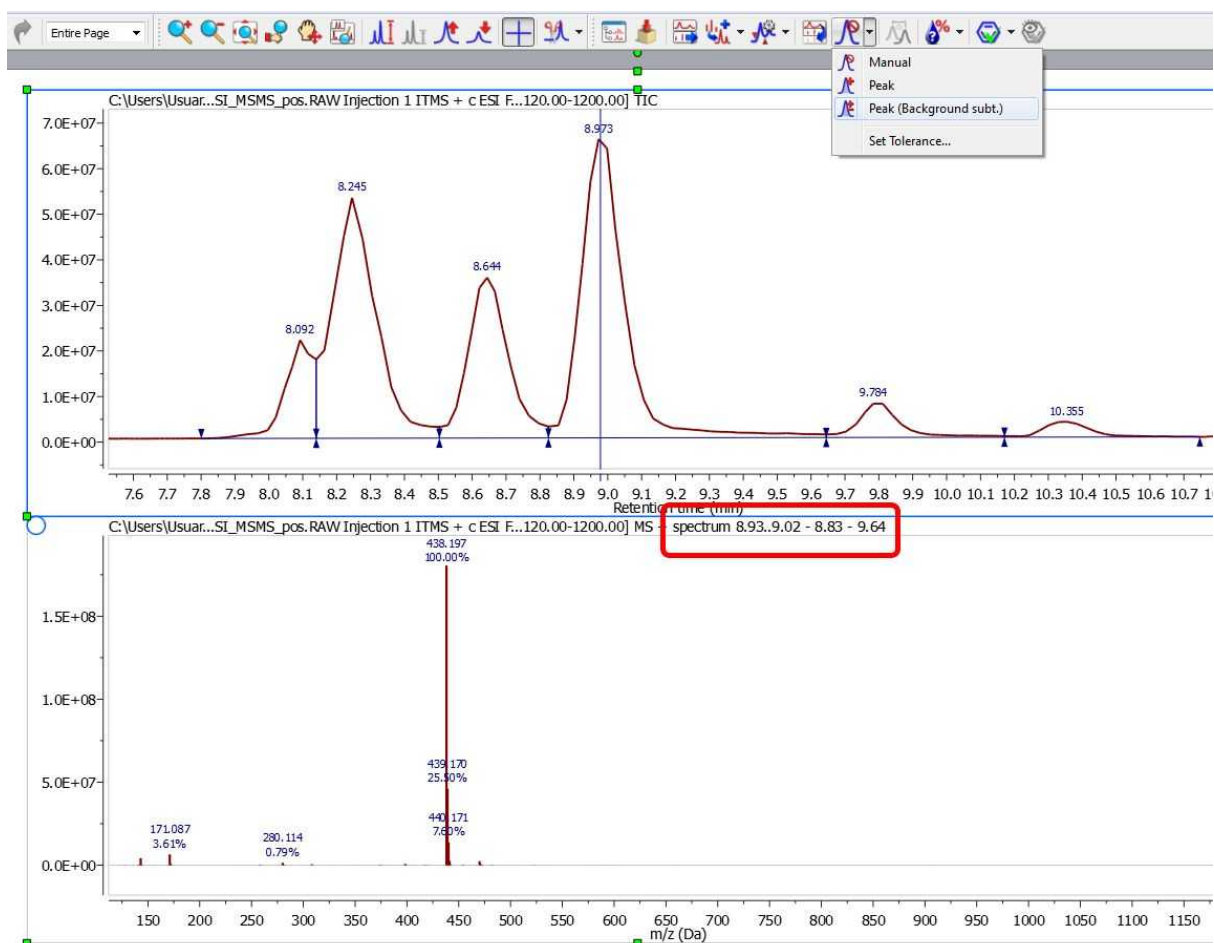

5. It is possible to add another MS spectrum to the page, just by clicking on the 'Append' button . Next, select the desired time span in the TIC in order to obtain the corresponding MS spectrum. In this case we have added the MS spectrum 738 which appears at 12.90 min.

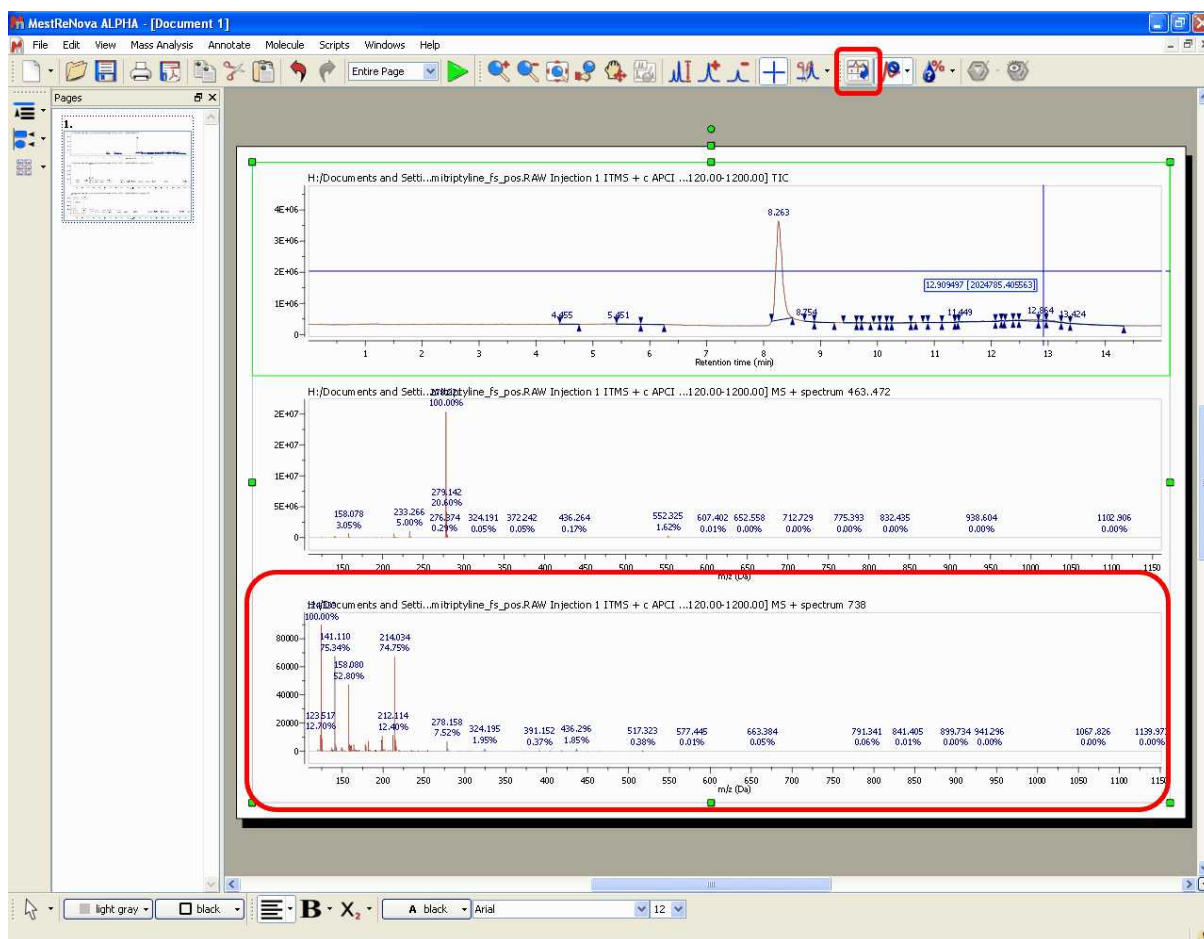

6. The 'Molecule Match' is very useful to see if a mass spectrum and a chromatogram match with one of the molecular structures of the document. With the TIC and the mass spectrum displayed on the screen and some .mol or .sdf files opened in the .mnova document, click on the 'Calculate Molecule Match' button of the toolbar . The 'Molecule Match' table will be displayed to see the results. This table will contain information about the 'Retention Time', Scan (number of spectrum), Match Score...

Molecule Match									
Report Copy Calc View Sett Setup									
	Molecule	Formula	Molecular Weight	atc	Match Score	Similarity	MS Purity	RT	Scan
1		C20H23N	277	✓	0.999	0.999	0.868	8.26	467
2		C19H21N	263	✓	0.544	0.544	0.000	8.26	467
3		C18H19NO	265	✗	0.000	0.000	0.000		
4		C20H24N2O2	324	✗	0.000	0.000	0.000		
5		C21H22N2O2	334	✗	0.000	0.000	0.000		

Clicking on any molecule will display the MICC (Molecular Isotope Cluster Chromatogram), overlaid

with the TIC.

In this case, the best result is for the compound number 1 (C₂₀H₂₃N). You can see in the picture below the MICC (in green) over the TIC (in red):

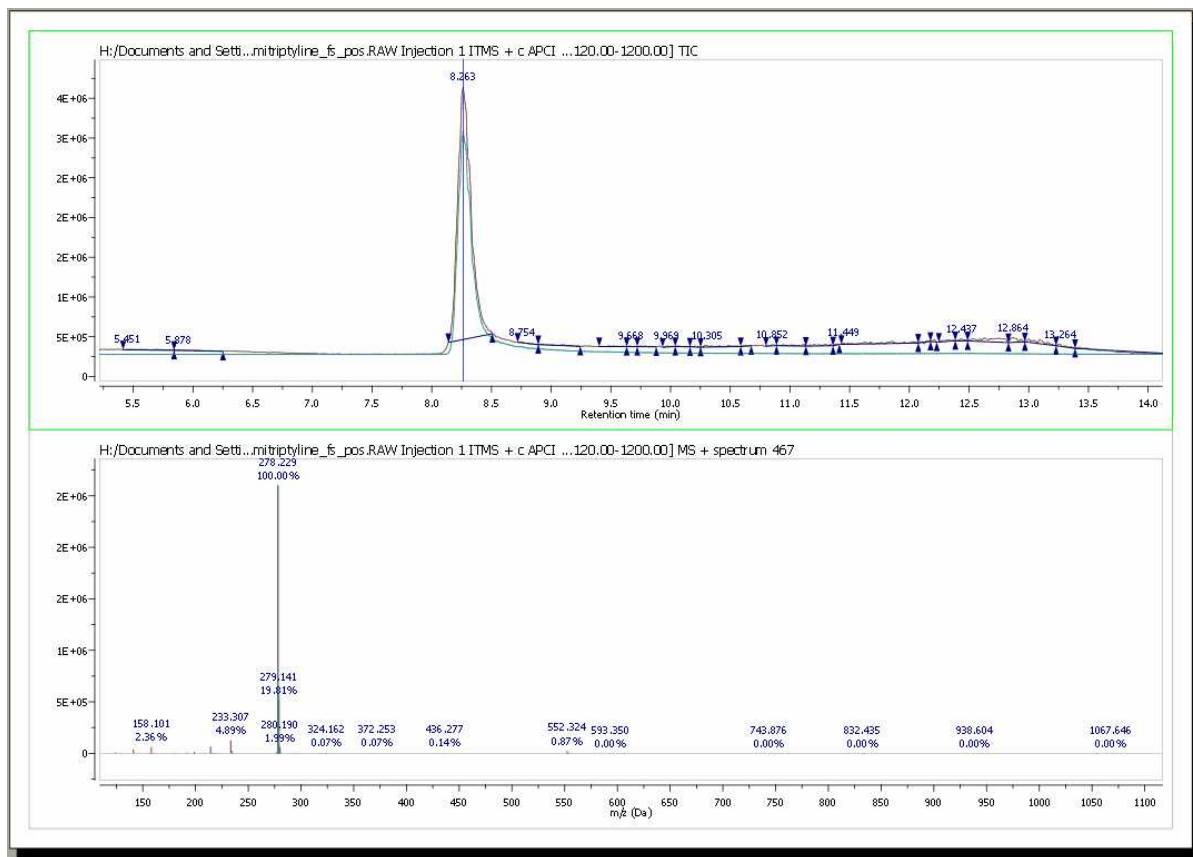

In addition, Mnova shows you in the chromatogram the retention time of the match (with a blue vertical line) and displays the corresponding MS spectrum (the number 467 in this case) overlaid with the theoretical one (in green at a M/Z around 278, in this case).

7. If you are using high resolution MS, it is possible to do an 'Elemental Composition' analysis of any peak of the Mass spectrum. First of all, follow the menu 'Mass Analysis/Elemental Composition/Constraints' or select the corresponding option in the scroll down menu of the 'Elemental Composition' icon of the toolbar:



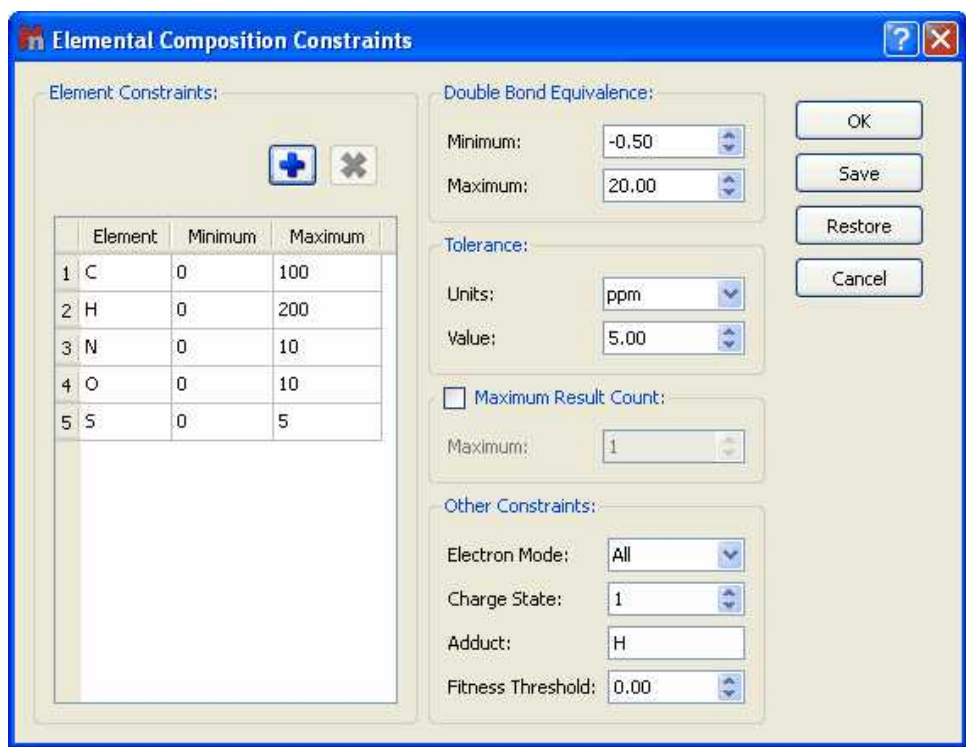

This will open the 'Elemental Composition Constraints' dialog box:



It will be possible to add more 'Element Constraints' just by clicking on this icon .

Once you have finished with the constraints, click on the 'Elemental Composition' icon  and select with the crosshair the desired peak of the Mass spectrum. A table with the results will be displayed (it is also possible to find this table under the 'View/Tables' menu). All the results obtained will satisfy the composition, DBE, and tolerance constraints, and will be ranked in decreasing order of fitness. Please bear in mind that a fitness value of 1 will be the perfect match.



Finally, the user will be able to save , print  or export to PDF , the document by clicking on the corresponding icon in the toolbar.

14.2 Working with the MS plugin

Mnova MS allows the user to navigate the TIC and display simultaneously any number of MS traces of interest, corresponding to specific points or to ranges in the TIC. All Mnova graphical functionalities (zooming, panning, create expansions, fit to height, increase/decrease intensities, etc) are available on all active spectra on screen. Spectra can be visualized in different modes: Standard, Peak spectrum, Background Subtracted Spectrum. Molecular structures (MOL files, SD files and copy/paste from ChemDraw, IsisDraw and ChemSketch) are also supported.

The Mass plugin of Mnova supports the following formats:

- HP Agilent (ChemStation, Ion trap, MassHunter)
- Thermo Scientific – Xcalibur
- Waters MassLynx
- Bruker (Compass, XMass)*
- JEOL MSQ1000
- SCIEX Analyst**
- Shimadzu***

- Data Explorer****
- mzXML/mzData (*.mzXML, *.mzData, *.xml)



* Please bear in mind that to open Bruker Compass MS spectra, you will need to have installed the Bruker Compass libraries (CompassXtract_3.0.1_01.exe) into your computer. You can get them for free by using this [link](#) after having registered

** To display SCIEX Analyst experiments, you will need to have installed the 'Analyst QS' software, which you can download from [here](#).

*** Mnova MS supports Shimadzu files, but it is necessary to have the Shimadzu software installed on the same computer for this to work.

**** It is necessary to have the Data Explorer software installed on the same computer for this to work.

In order to load any sample in Mnova just Drag&drop the corresponding file to Mnova to display the TIC (at the top of the window) and the MS spectrum of the highest signal. You can also use the '**File/Open**' menu, the keyboard shortcut **<Ctrl+O>** (Cmd+O in Mac) or click on the '**Open**' icon on the toolbar.

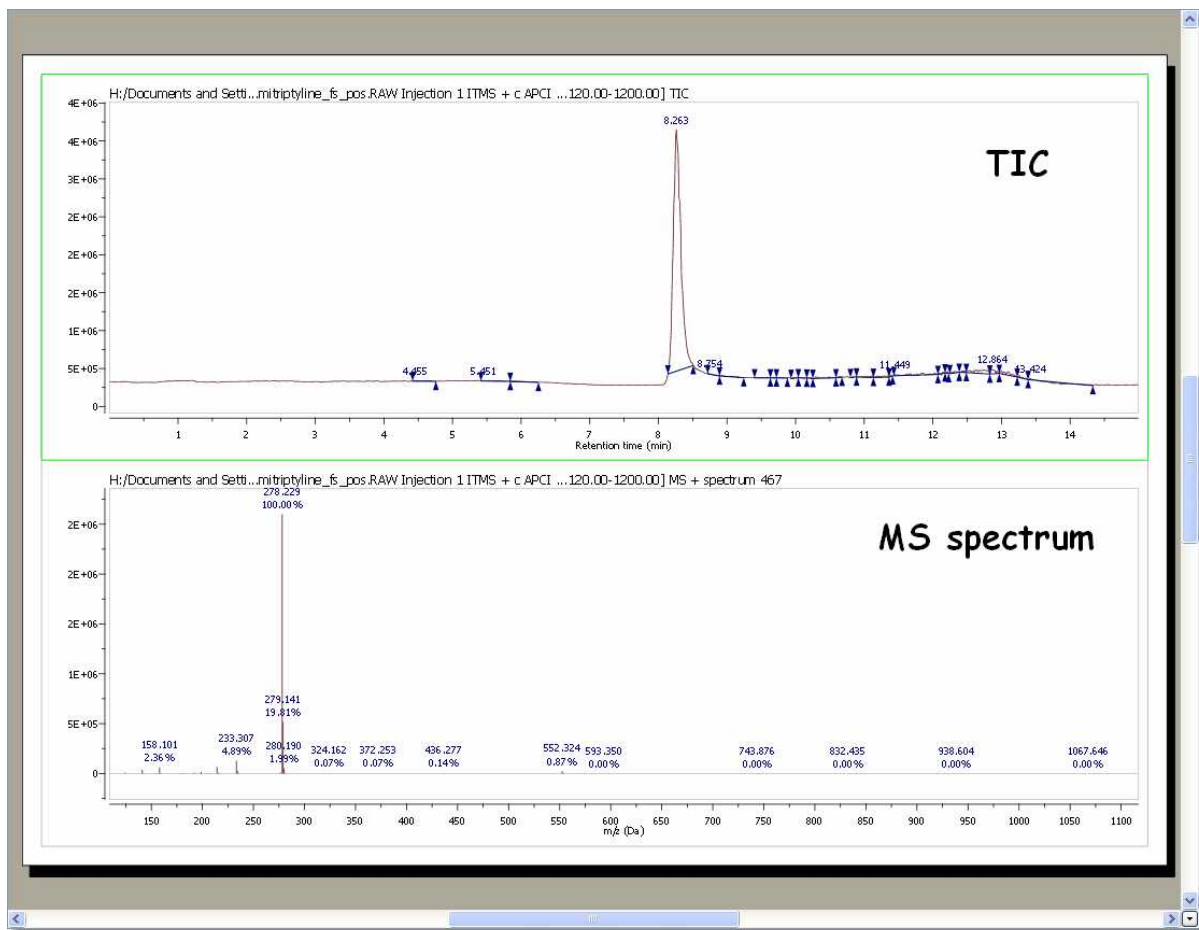

Double clicking on the spectral window will display the properties dialog box. From here you can modify the Grid, Axes, Line, Peaks and Title properties of the TIC and MS spectrum by selecting the corresponding tab in the dialog box. For further information about the Properties, please click [here](#).

You can expand any scale (in either the TIC or MS) by using the 'zoom in' feature, which can be accessed by just pressing the 'Z' key or by using the corresponding icon of the toolbar . Please note that the intensity of the expanded region will be automatically fitted. However if you are not happy

with it, you can change it by just clicking on the 'Increase or Decrease Intensity' icons: . Or by using the '+' or '-' keys.

It will be possible to select multiple chromatograms of the same dataset to zoom in/out simultaneously. The chromatograms can be selected as in a stack of NMR spectra:

- To select a single spectrum, left click on the spectrum while keeping pressed the Alt key
- To deselect a spectrum: left click + Ctrl + Alt
- In order to select multiple spectra, follow the same operation as above while keeping pressed Ctrl and/or Shift keys.

You can select any other mass spectrum for a particular time point with the crosshair feature  just by clicking on the corresponding signal of the TIC. For example in this case, we have selected the spectrum number 467 at a 'Retention time' of 8.26 min:

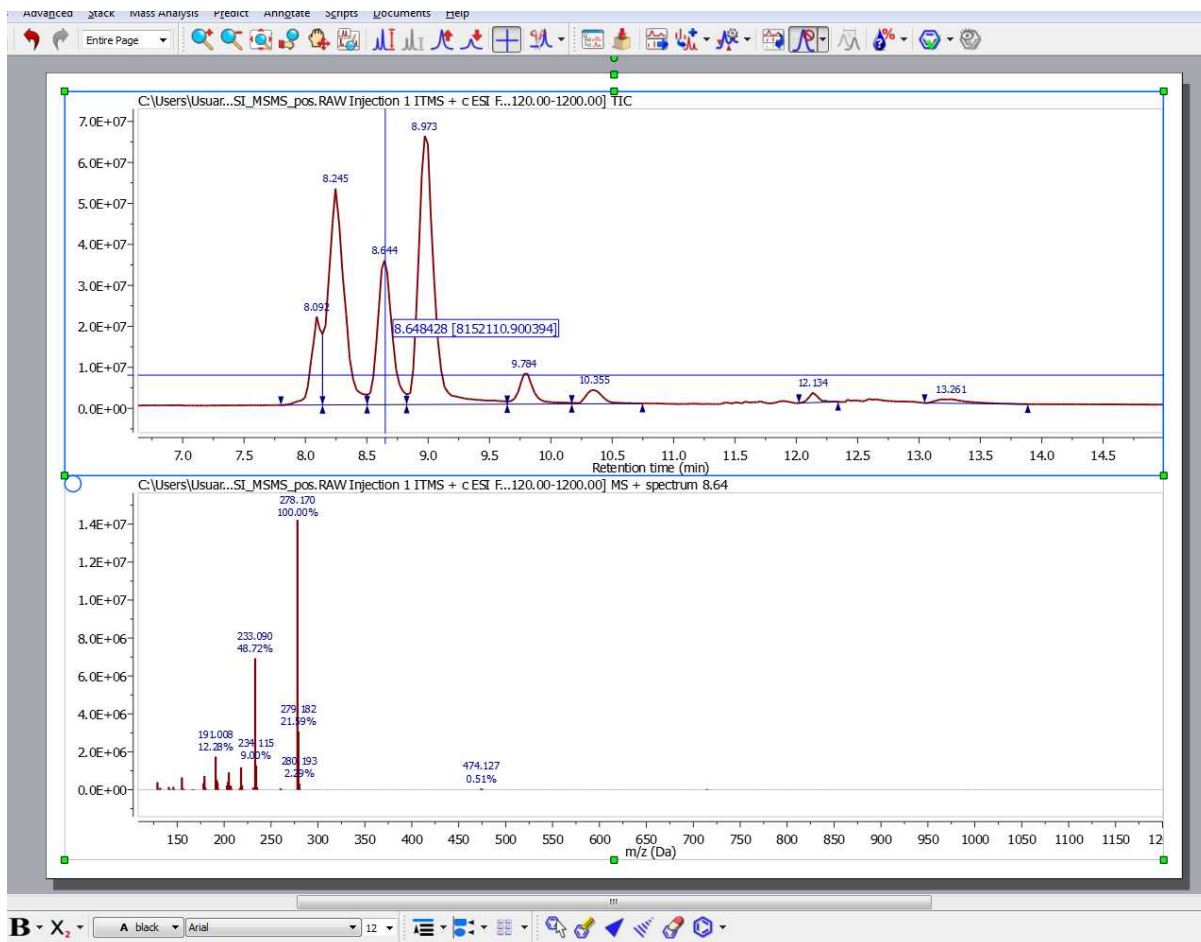

14.2.1 MS Browser

This panel can be showed by clicking on the corresponding icon  (or by following the menu 'View/Panels/MS Browser' or 'Mass Analysis/Show MS Browser'). It is very useful and we recommend to dock it to the page navigator. From this panel you can easily open additional chromatograms or spectra at the same item:

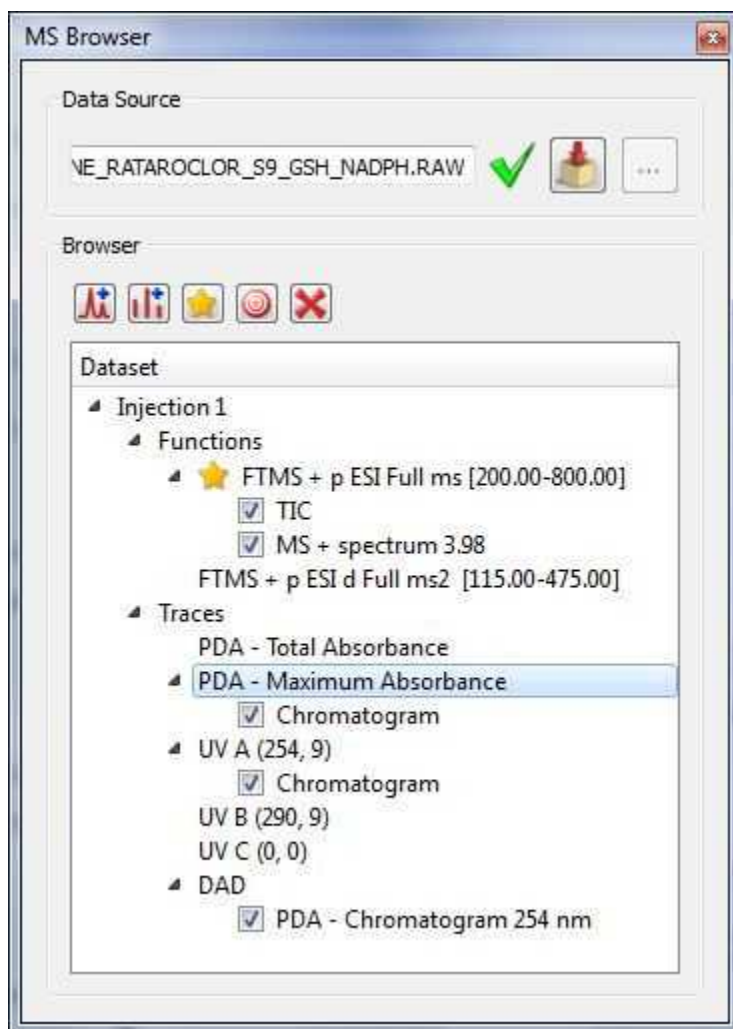

This dialog box will contain information about the 'Data Source'. If the current spectrum contains the original spectrum file, the 'Data Source' will show a green tick mark. If not, it will show a red cross (and the spectrum will have a red frame); which indicates that you will not be able to load any other part of the chromatogram and you will only be allowed to work with the spectrum that you have on the screen.

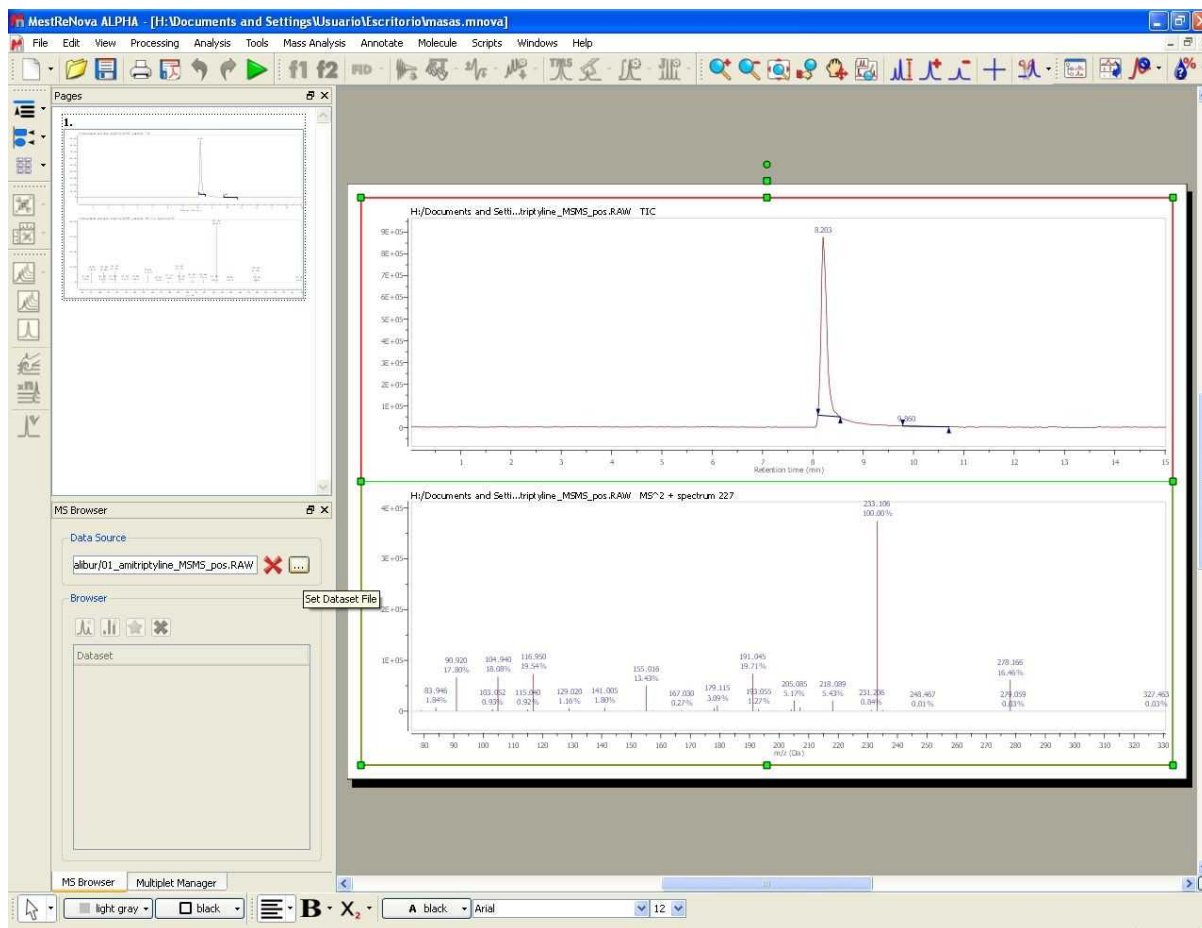

Attention:

Please bear in mind that when you save a Mnova document with a TIC and a Mass spectrum, by default the raw file is not stored in the document (to avoid the generation of huge files), so you will need to keep the original raw file on your computer if you plan to continue working with the experiment in the future.

If you want to store the raw file on the Mnova document, click



on the 'Fetch Full Dataset' button of the MS Browser.

Please make sure that if you change the path of the raw file (after having saved a Mnova document); you will need to load it by clicking on the 'Set Dataset File' button (of the MS Browser table) if you want to work with the experiment. Be careful in this situation, because Mnova will not be able to identify if you load an erroneous raw file (instead of the correct one).

You can hide any chromatogram or MS spectrum by checking the corresponding check box in the 'MS

Browser' or by selecting 'Hide Plot' in the context menu of the spectrum (which can be accessed by right clicking on the spectral window).

If you want to delete the plot from the Browser, just select it and click on the red cross button . The same result will be obtained by selecting 'Delete Plot' in the context menu. You can also hide and extract to any page the selected plot.

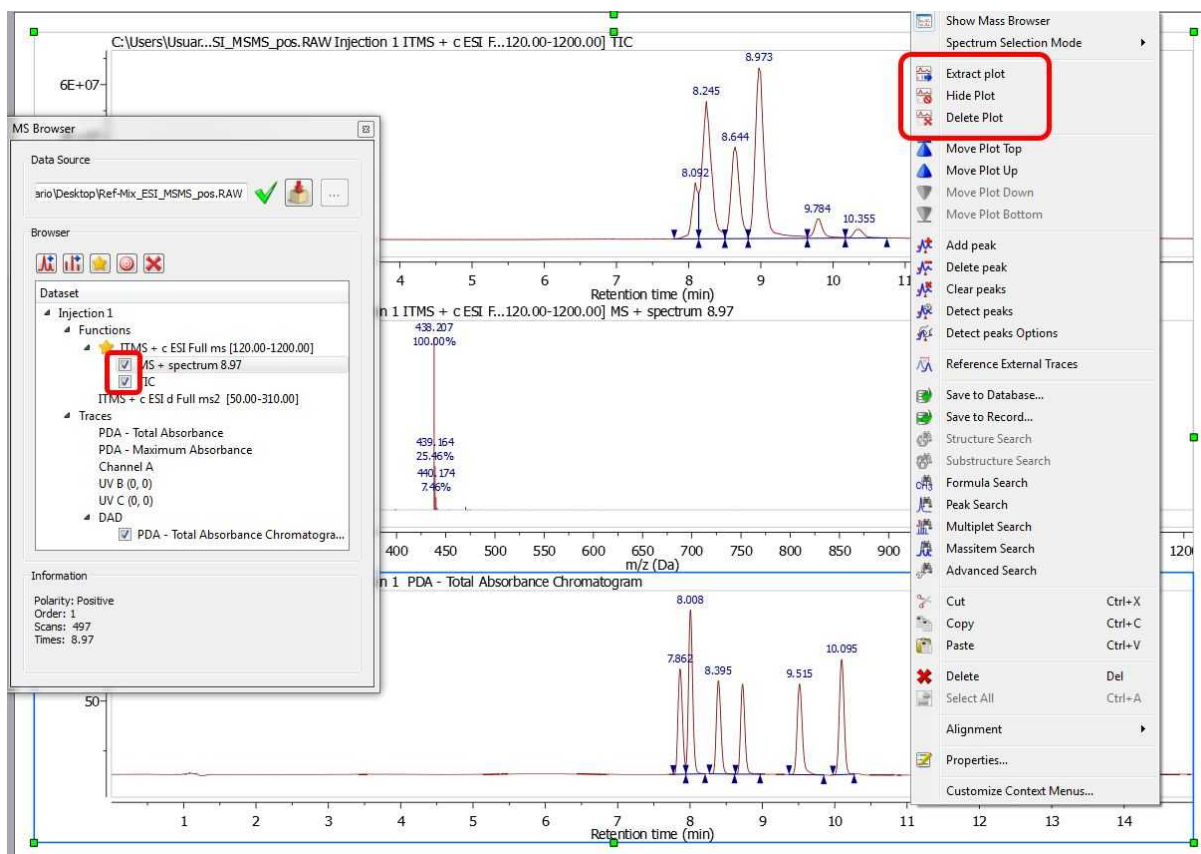

Clicking on the 'New Chromatogram' icon  will display the corresponding dialog box, which will allow you to open the TIC, Base Peak or the Mass spectrum

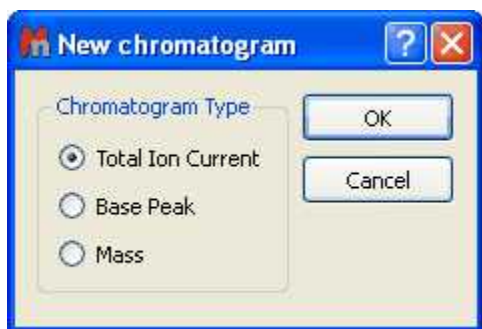

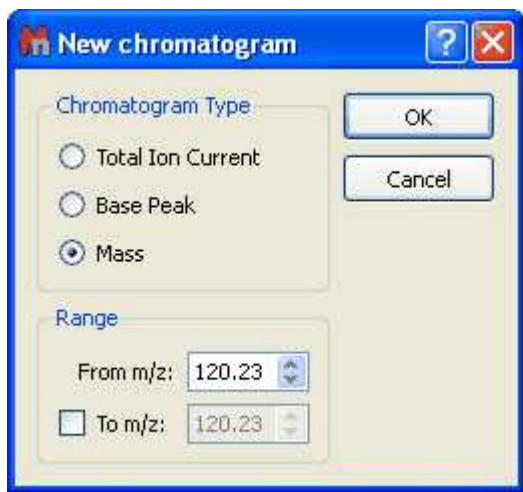

- **TIC** (Total Ion Current): The sum of all the separate ion currents carried by the different ions contributing to a complete mass spectrum or in a specified m/z range of a mass spectrum (this is sometimes called the reconstructed ion current).

- **Base Peak:** The peak in a mass spectrum corresponding to the separated ion beam which has the greatest intensity which is assigned a relative intensity value of 100. The lesser peaks are reported as a percentage of it.
- **Mass:** clicking on this option will display the below dialog box which will allow you to select the range of the chromatogram between two values of m/z. You will obtain the TIC corresponding to the selected m/z range.

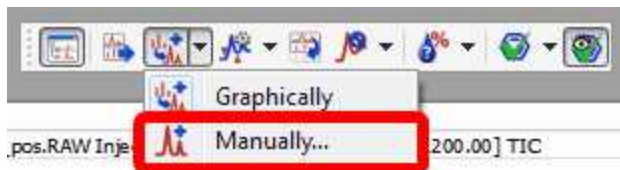

You will obtain the same result by selecting 'Manually' on the scroll down menu of the 'Open Mass chromatogram' button of the toolbar:



It will also be possible to display any trace (i.e PDA or UV chromatograms) by selecting it on the MS Browser and then clicking on the 'Open new Chromatogram' icon .

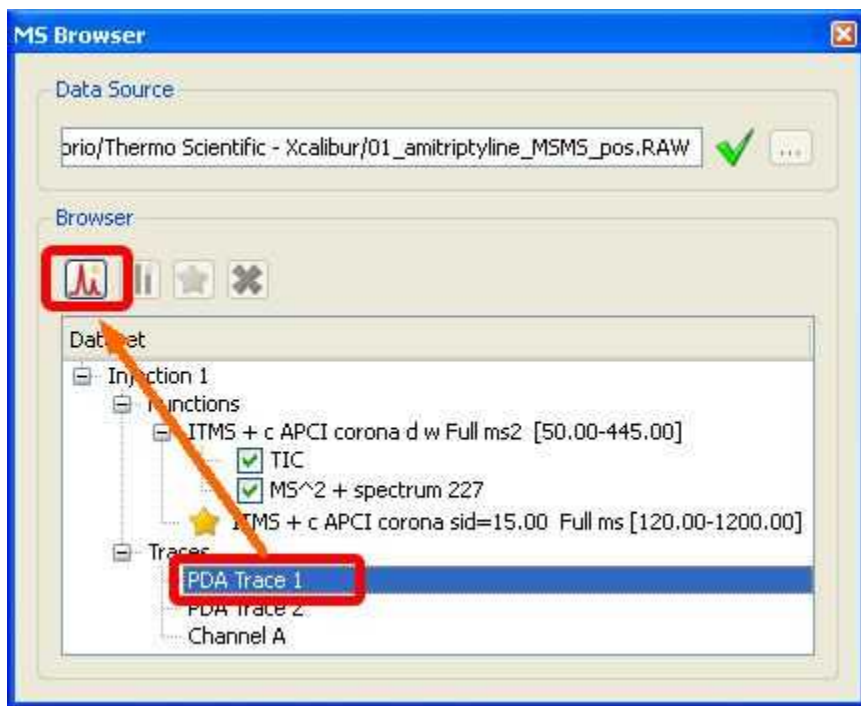

If your dataset contains UV traces (DAD), it will be also possible to extract them or even to select a range in the wavelength; just by selecting the applicable option after having clicked on the 'Open new Chromatogram' icon 

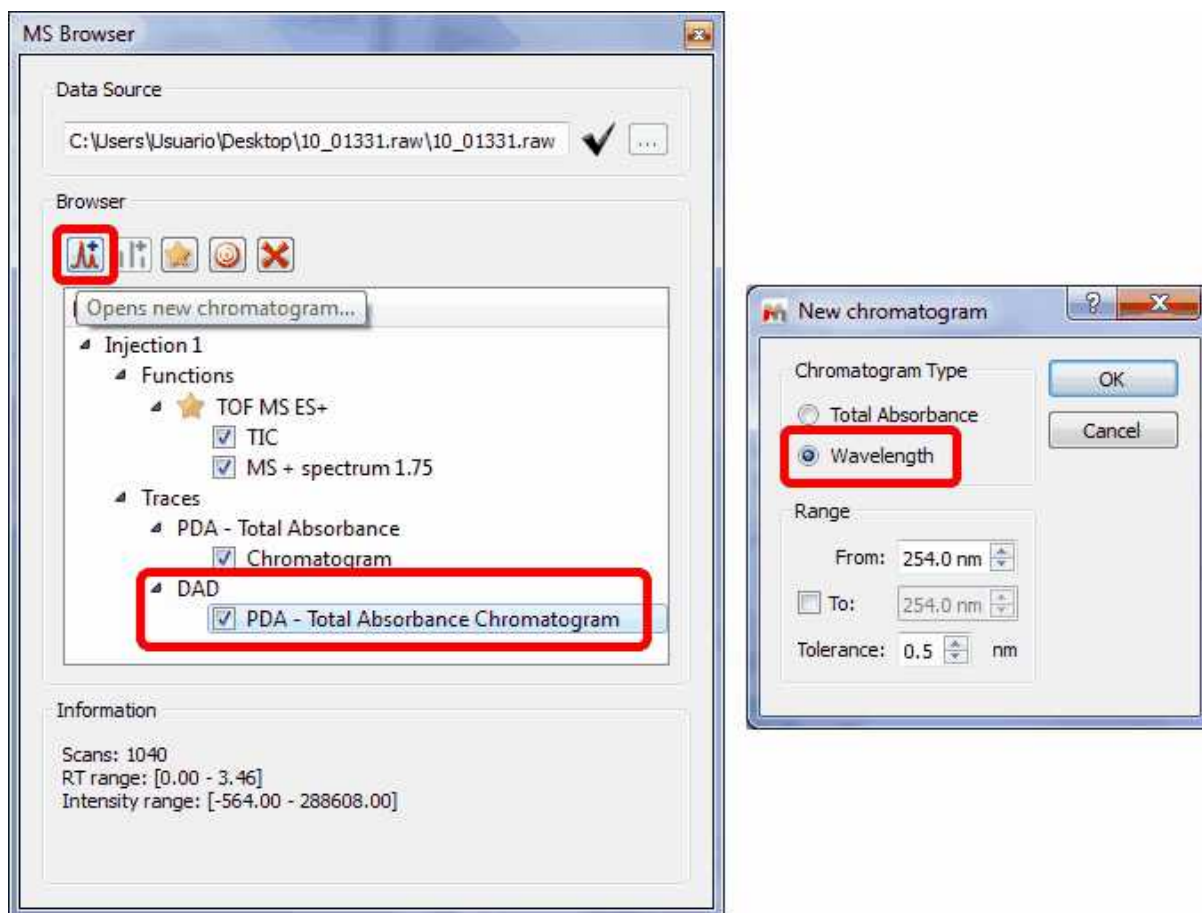

From the PDA-Total Absorbance Chromatogram, you will be able to extract the complete **UV spectrum**.

To select a UV spectra: the dataset must have the full UV spectra set (and not just a single or a set of UV chromatograms, ie, MS browser panel must show a sub-item called DAD under the Traces item).

Using the crosshair mode and **clicking** on a UV chromatogram while **holding Alt** pressed, will display the UV spectrum for the clicked retention time.

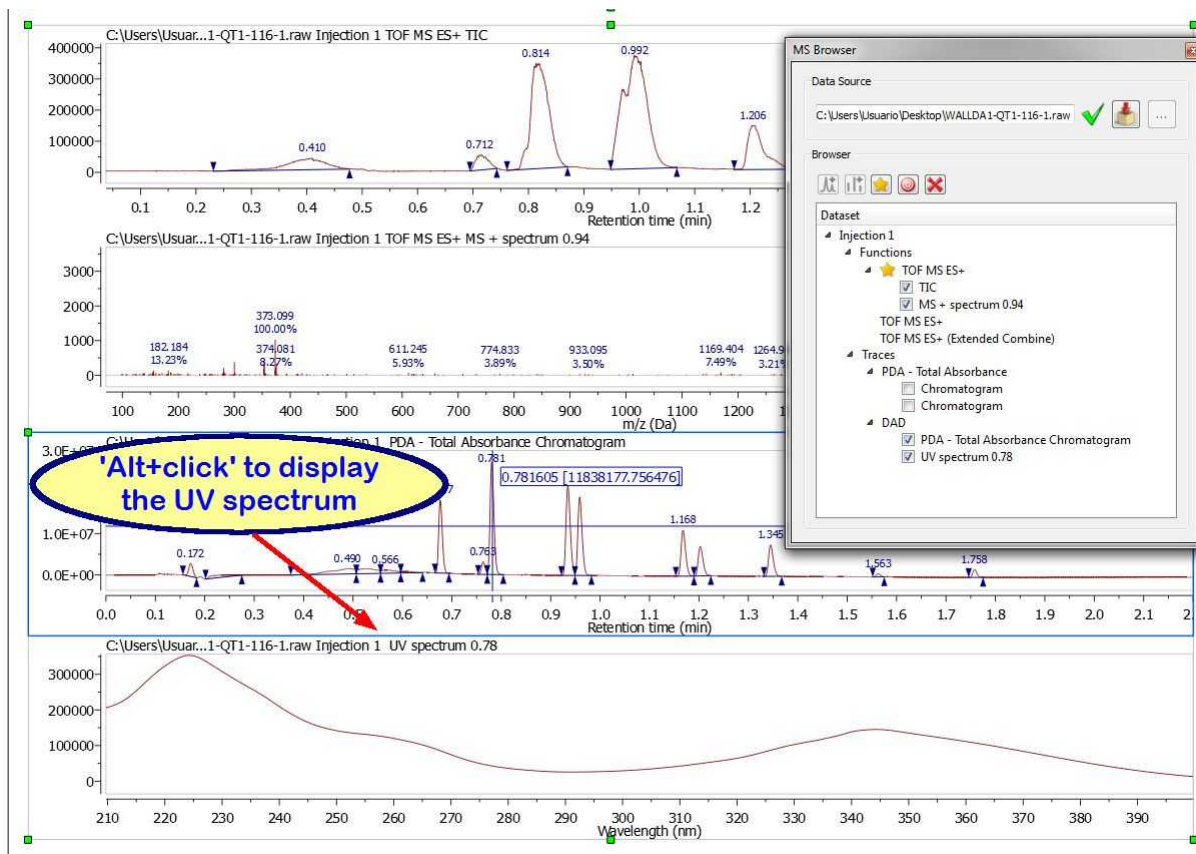

You can also Co-add UV chromatograms by clicking and dragging the crosshair to select a range on DAD chromatograms as you can do with the TICs

Highlighting any function in the MS Browser and clicking on the 'New Spectrum' icon  will display the corresponding dialog box which will allow you to open the desired spectrum by just typing the number on the edit box:



The below picture will show you a TIC (red), a Mass spectrum (number 467), the Base Peak (green) and the chromatogram between $m/z=150.23-320.23$ (pink):

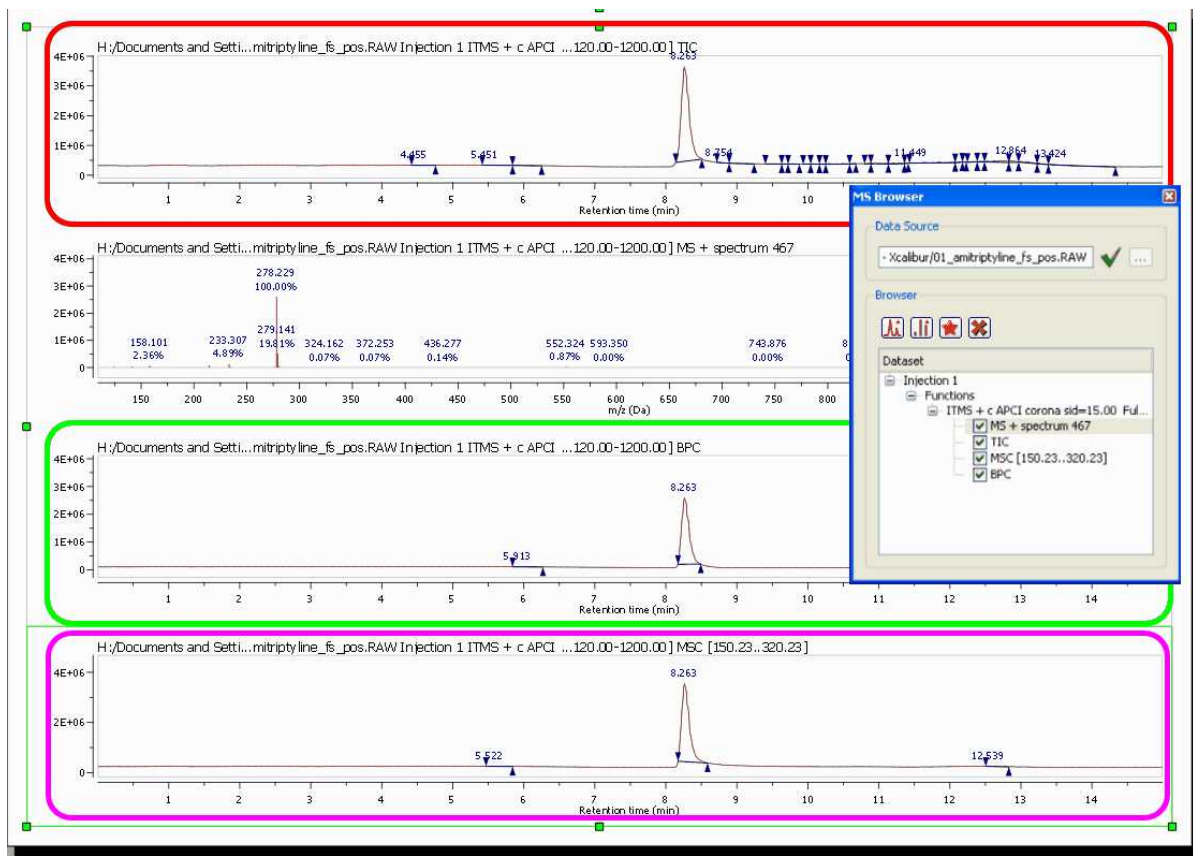

In the example below, you can see two TICs of two different functions:

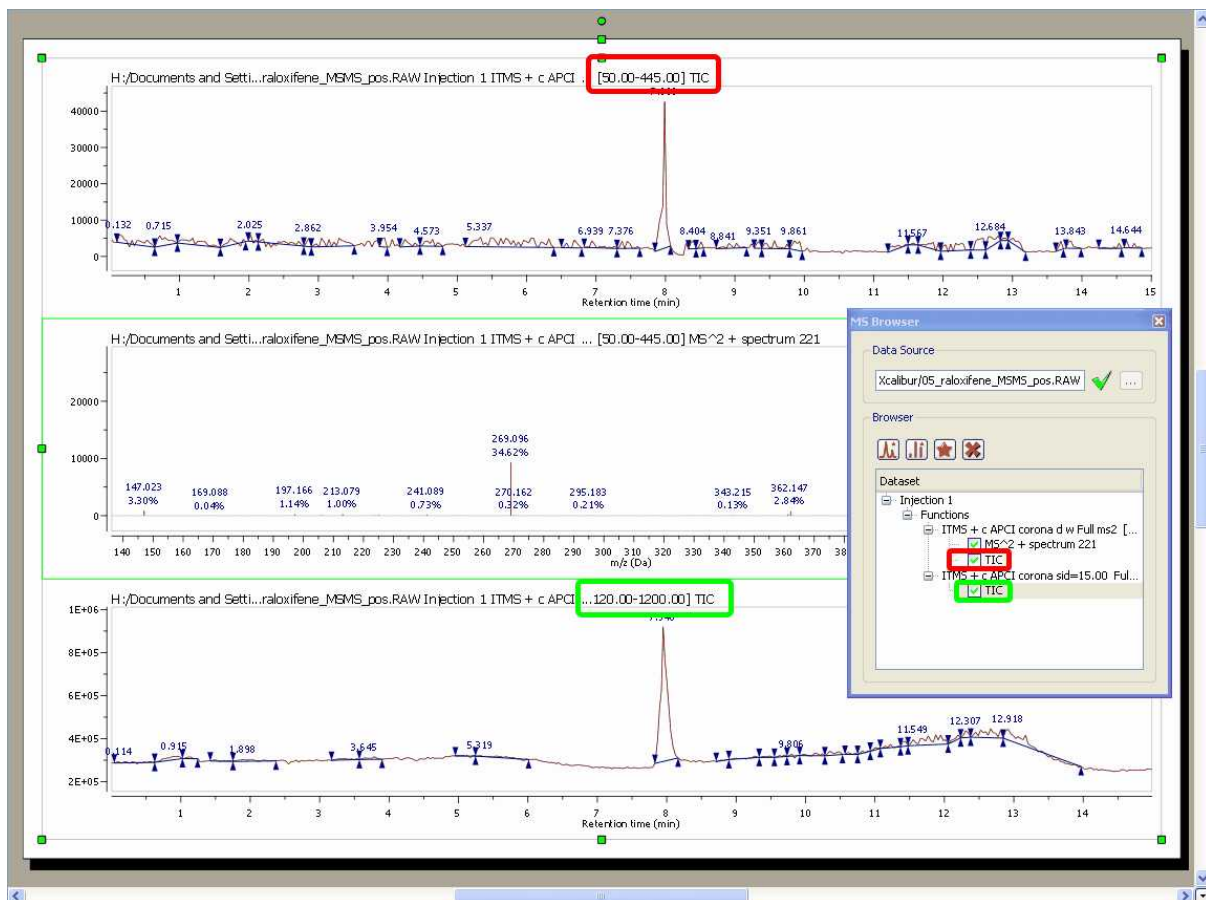

Selecting a function on the MS Browser window and clicking on this button , will set the selected function as active. This option will allow you to work with the traces chromatogram of different functions.

Please bear in mind that different mass spectrometer acquisition data systems do different things with the names of traces. When we import traces, we do our best to retrieve sensible names, but they are not always present (or appear as 'Channel A' for example). We hope that the chemist who acquired the data will usually know what "Channel A" actually is.

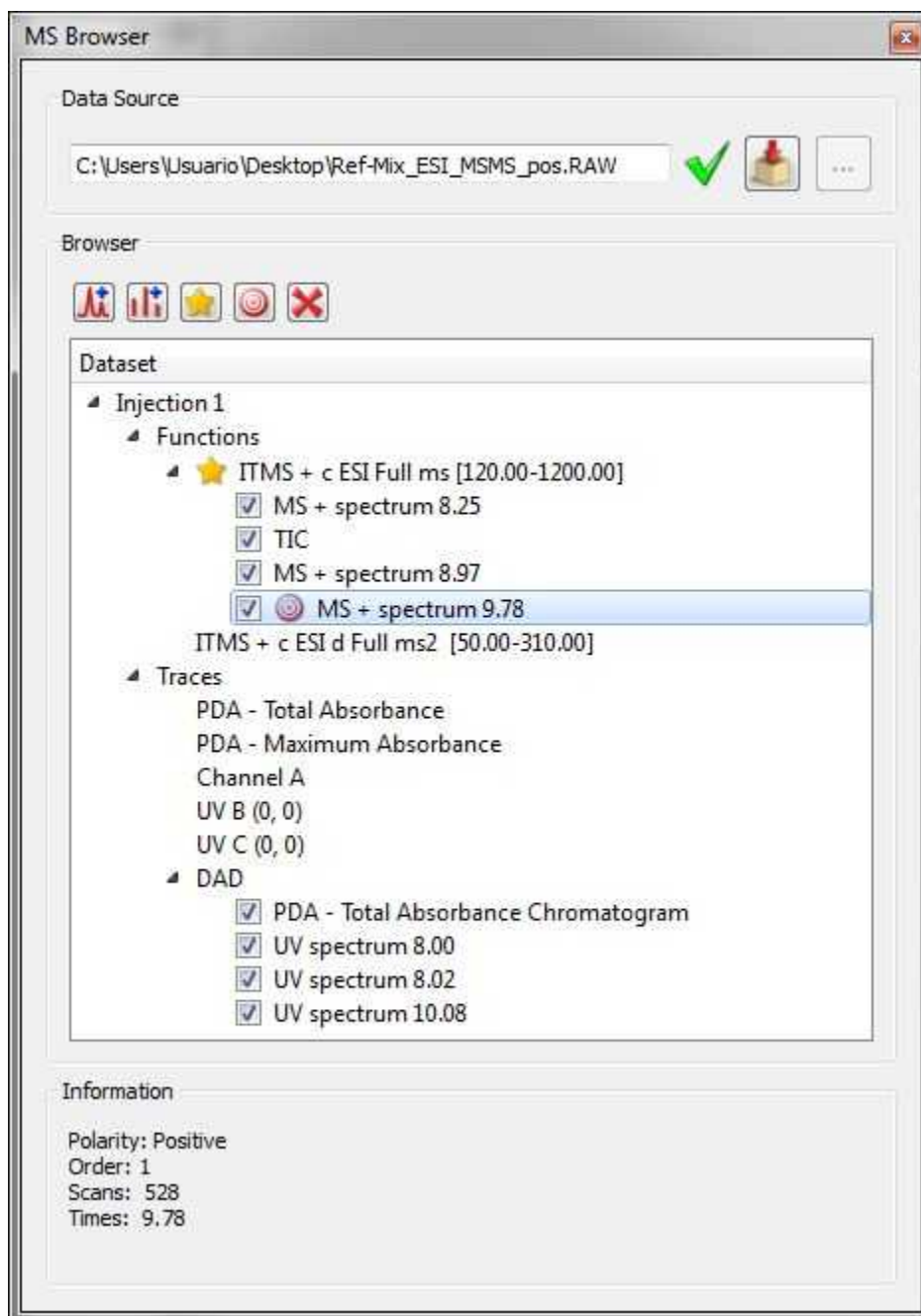

It will be possible to select several chromatograms or spectra in the same page, for example to 'zoom in' or extract them to a new page at the same time. To do it, just hold down the 'Ctrl+Alt' key and click. To release the selection, press 'Ctrl+Alt' and click on the undesired item:

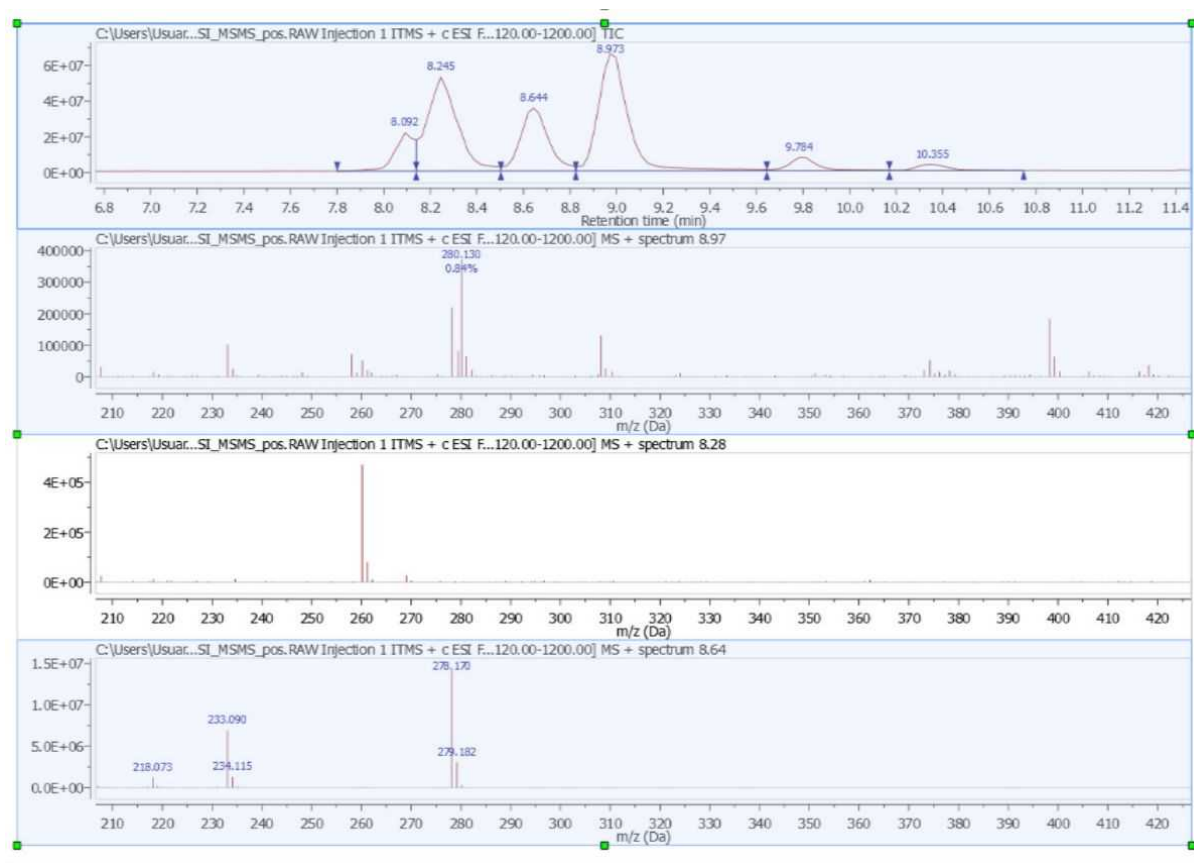

14.2.2 Mass Analysis

Mnova MS allows the user to carry out fully automatic analysis of LC/GC/MS data. Easily obtain:

- Automatic TIC integration values and MS trace m/z values
- Automatically compute potential Elemental Compositions for a given mass ion peak
- Automatically match proposed molecular structures to a TIC spectrum

The Mass Analysis menu contains three useful features:

- **Peak Detection**
- **Spectrum Selection Mode**
- **Elemental Composition**
- **Molecular Match**
- **New Mass chromatogram**
- **Reference External Traces**

Let's take look at them one by one.

14.2.2.1 Peak Detection (Integration)

It is possible to integrate the desired peaks of your TIC chromatogram with Mnova MS by following the menu 'Mass Analysis/Peak Detection' or by using the corresponding icon of the toolbar:

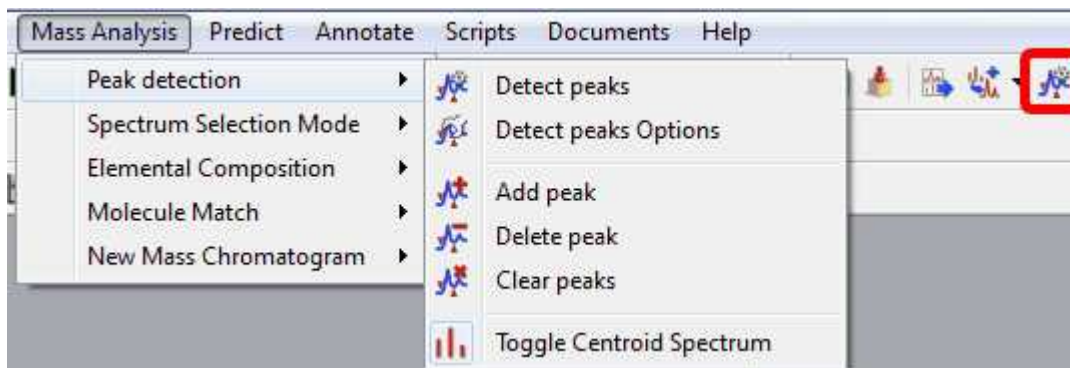

You will find several features under the 'Peaks Detection' menu:

Detect Peaks: applies an automatic peaks detection to your TIC.

Detect Peaks Options: from here you can customize the threshold of the minimum area of the peaks for the automatic detection.

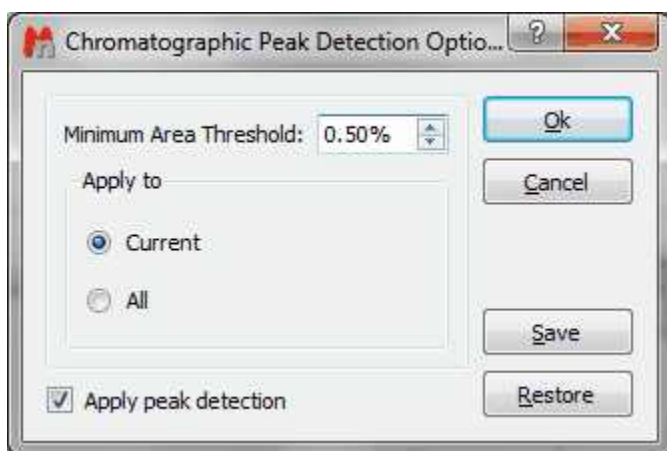

Add/Delete and Clear Peaks: these features are used to manually add or delete peaks to your TIC or to delete all the peaks.

Please bear in mind that it is possible to change the integral region of any peak just by clicking and dragging on the wedges:

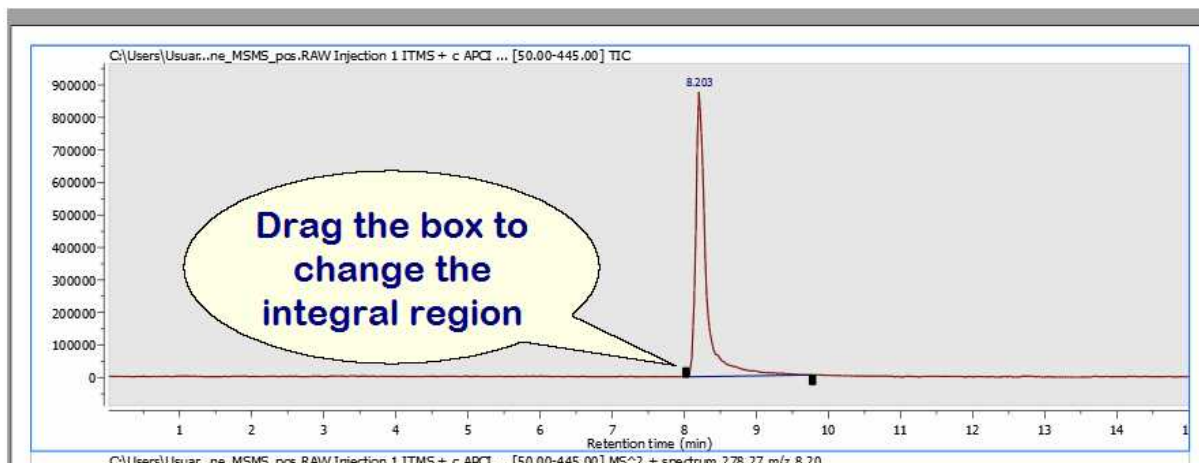

It will be also possible to **freely** move the wedges. To do that, you will need to move one of the integrals handler while shift is pressed.

Toggle Centroid Spectrum: This is a toggle to switch between profile and centroid mode of the MS spectrum.

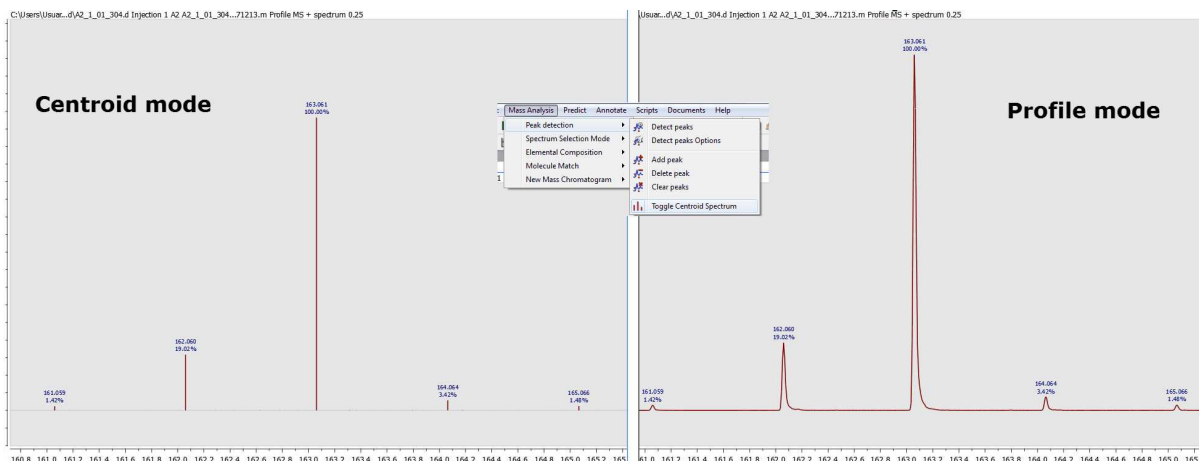

14.2.2.2 Spectrum Selection Mode

This feature will allow you to add additional Ms spectra to your document and also to generate 'CoAdds' and subtractions.

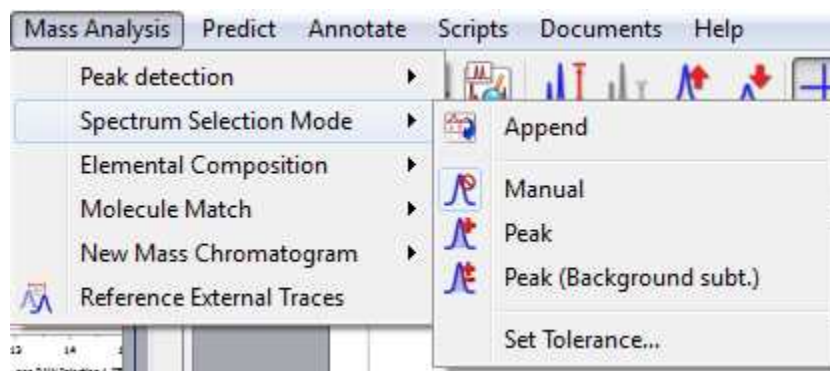

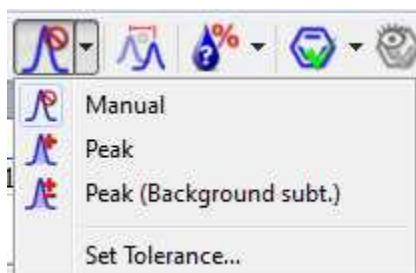

Append: This feature will allow you to add additional MS spectra to the main window just by selecting 'Append' in the corresponding menu and clicking with the crosshair on the corresponding signal of the TIC. If the 'Append' option is not selected, the current MS spectrum will change after having clicked on the corresponding signal of the TIC.

In this case we have added the MS spectrum 738 which appears at 12.90 min.

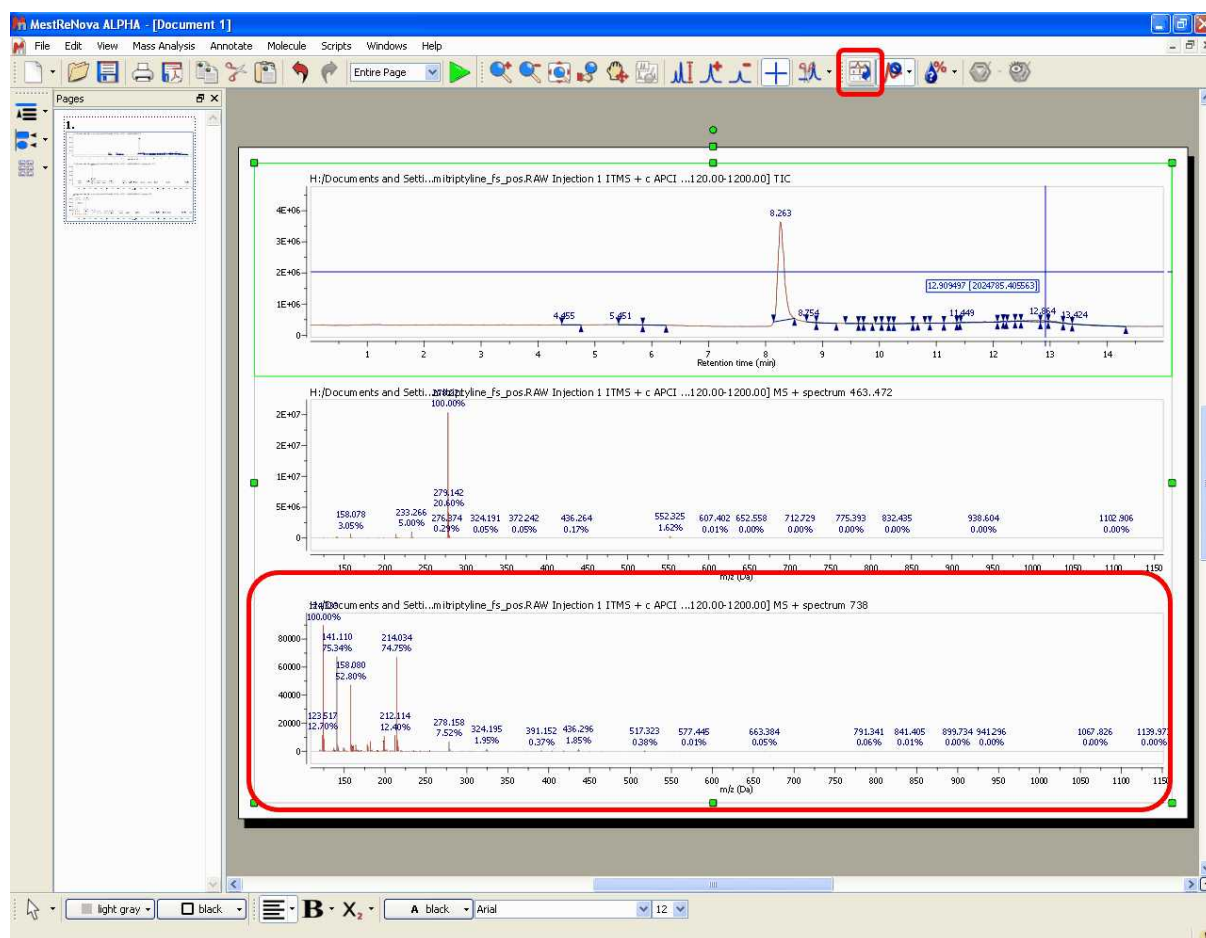

You can combine the 'Append' option with the 3 different modes of the crosshair (Manual, Peak and Peak (Background Subt)):

Manual: This is the default mode of the crosshair. In this mode, you can select any other mass

spectrum for a particular time point with the crosshair feature  just by clicking on the corresponding signal of the TIC. For example in this case, we have selected the spectrum at a 'Retention time' of 8.64 min:

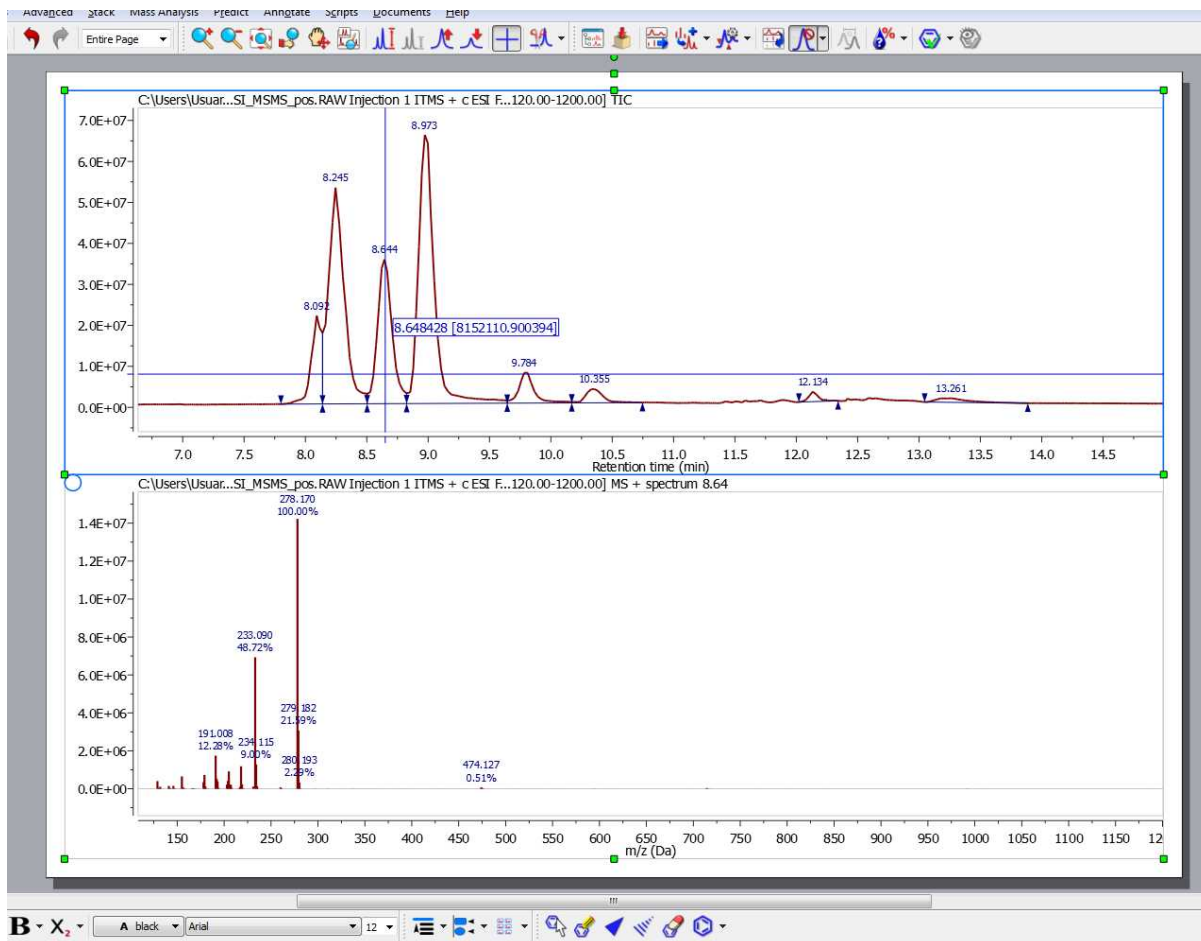

If you need to average the mass spectra over a certain time range (CoAdd), just hold down the left mouse button (after having selected the crosshair) and drag over the appropriate time span in the TIC. A label at the top of the MS will inform you about the spectrum ranges (red rectangle in the picture below):

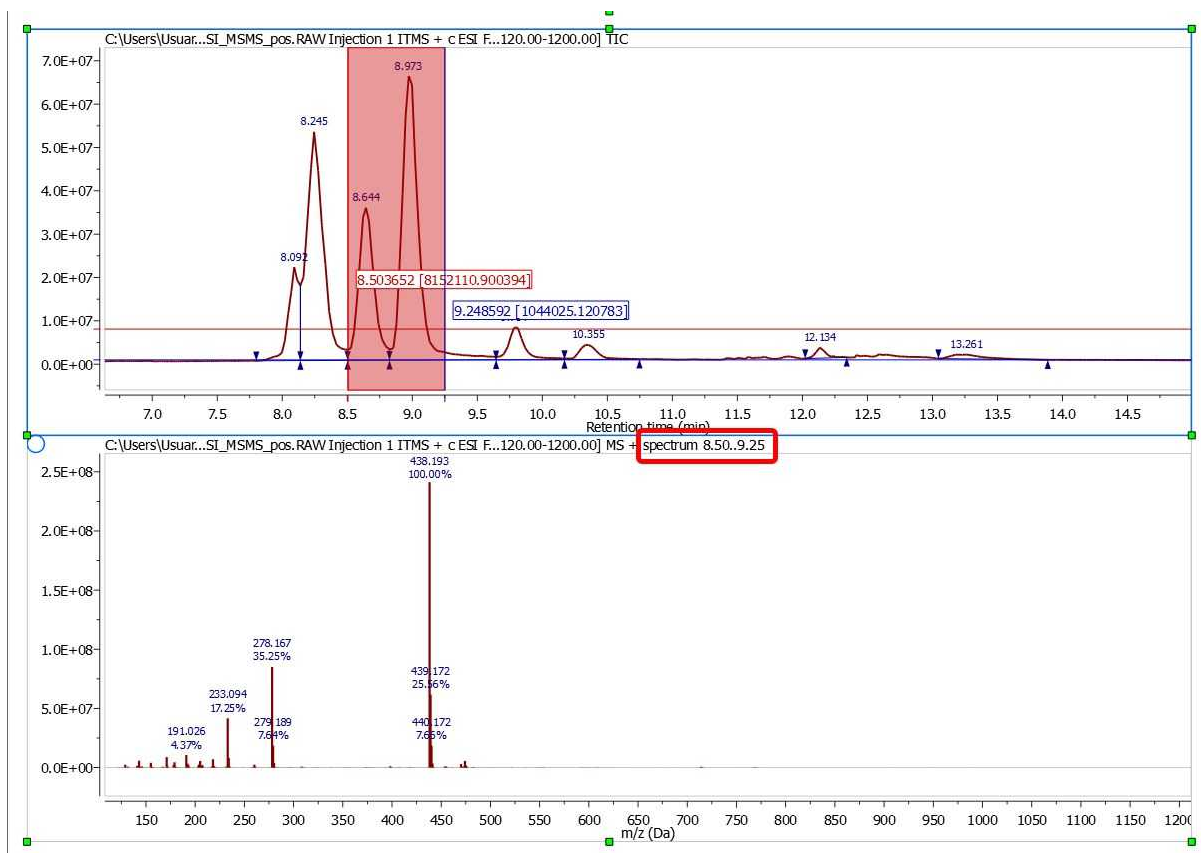

After having done the 'CoAdd' you can do a 'subtraction' by just selecting the 'Crosshair' feature, pressing the 'SHIFT' key and holding down the left mouse button and dragging over the desired time span in the TIC.

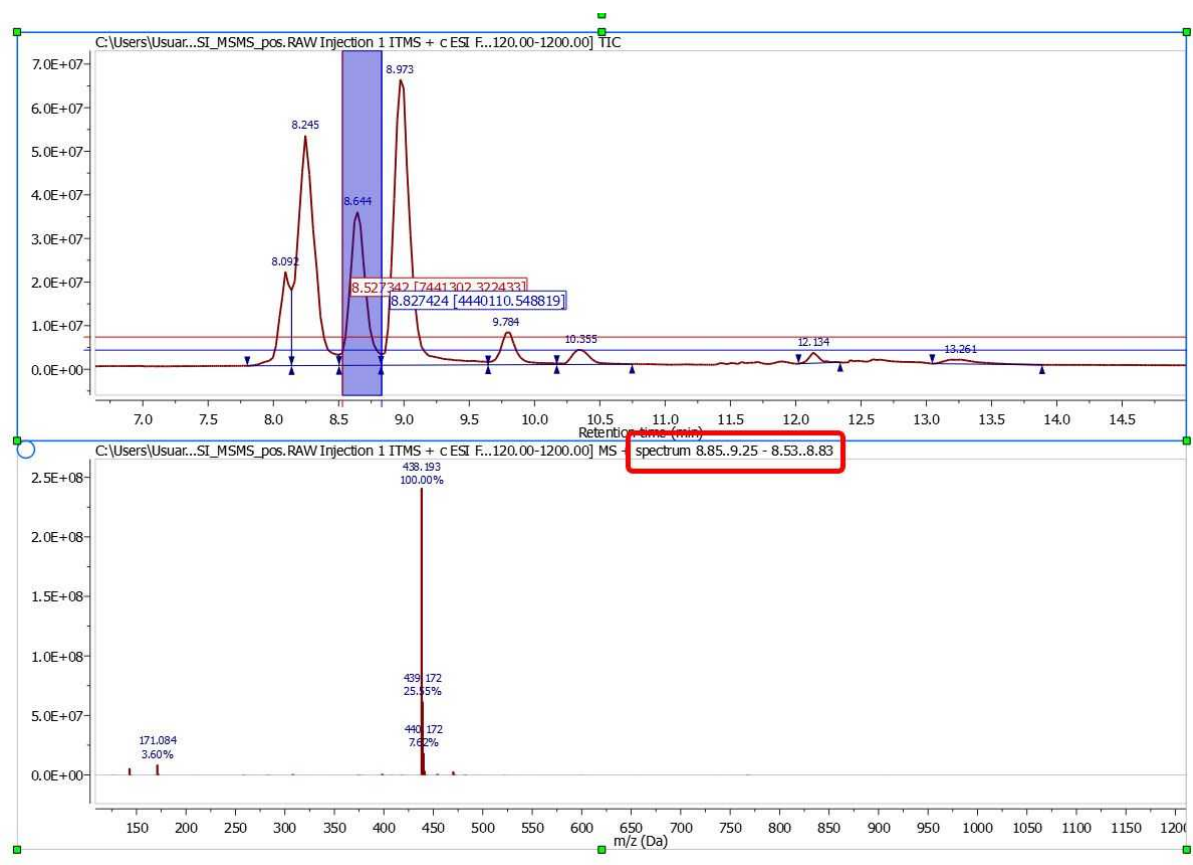

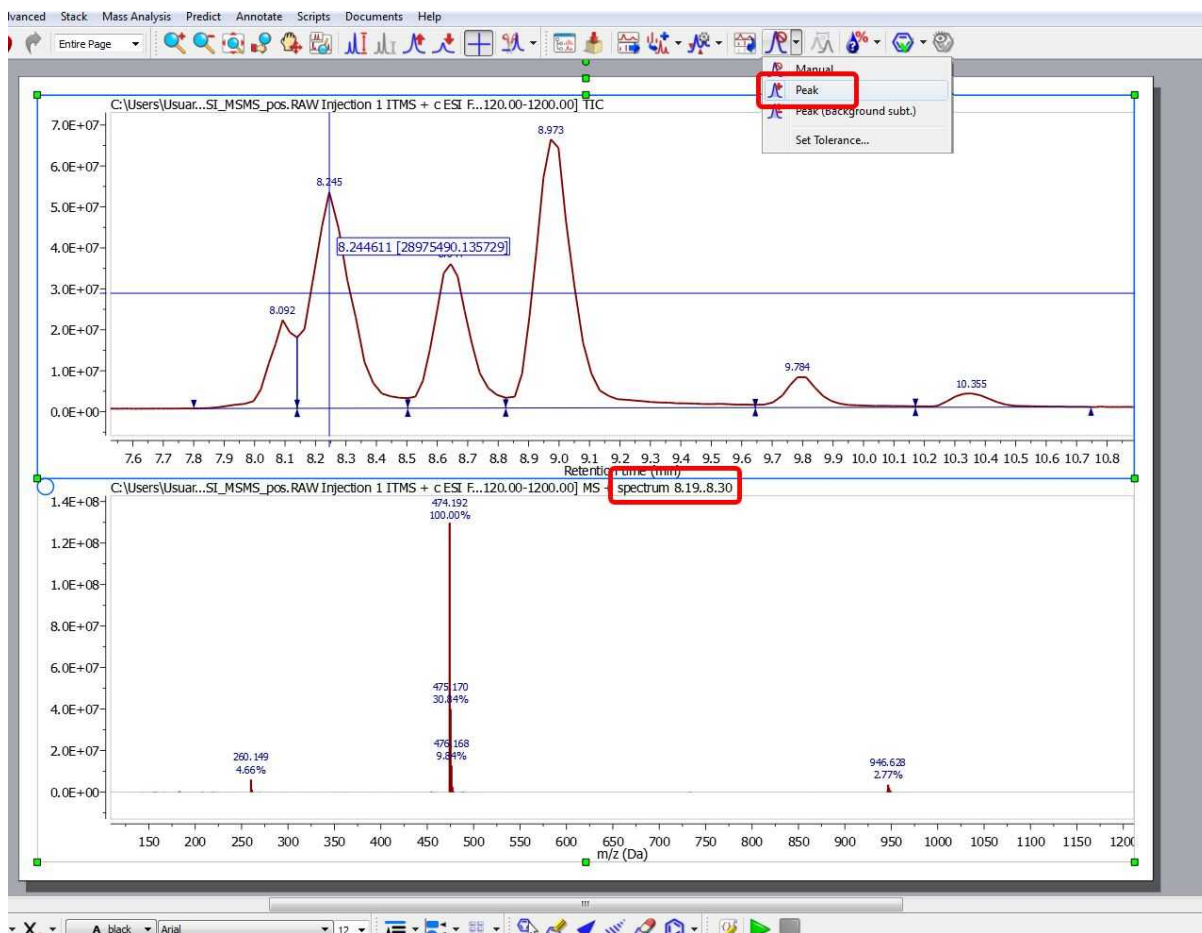

Peak:  Selecting this mode and clicking with the crosshair on the corresponding signal of the TIC, will generate a 'CoAdd' of the middle part of the peak. The spectra from the middle half are used because they're the highest intensity and s/n. Spectra at the peak edges are then the opposite, lower s/n and more likely to contain background. Often when a peak elutes, background is actually suppressed, especially with higher concentration components. This approach is a common technique.

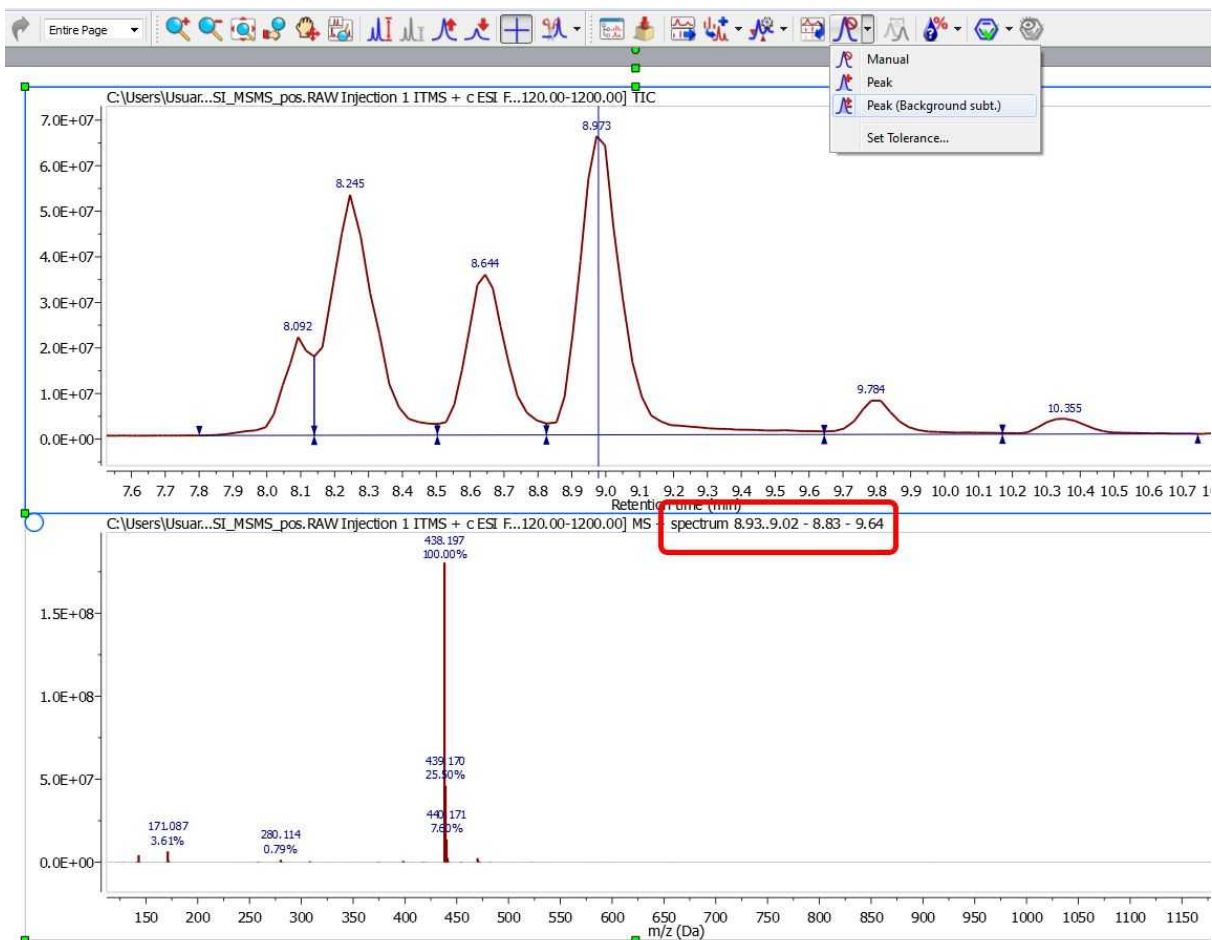

Peak (Background sub.): 

To generate a 'CoAdd' of the whole peak without the tail-peaks just select the mode 'Peak (Background Subt.)' under the 'Mass Analysis/Spectrum Selection Mode' menu and click with the crosshair on the desired signal of the TIC:



When you are in the spectrum selection mode (with the append mode disabled), it will be possible to select graphically (by checking the blue circle ) which of the plots must be replaced when you select a spectrum in a chromatogram. The selection target can be also done from the MS Browser, just by selecting the applicable MS and clicking on the 'selection' button .

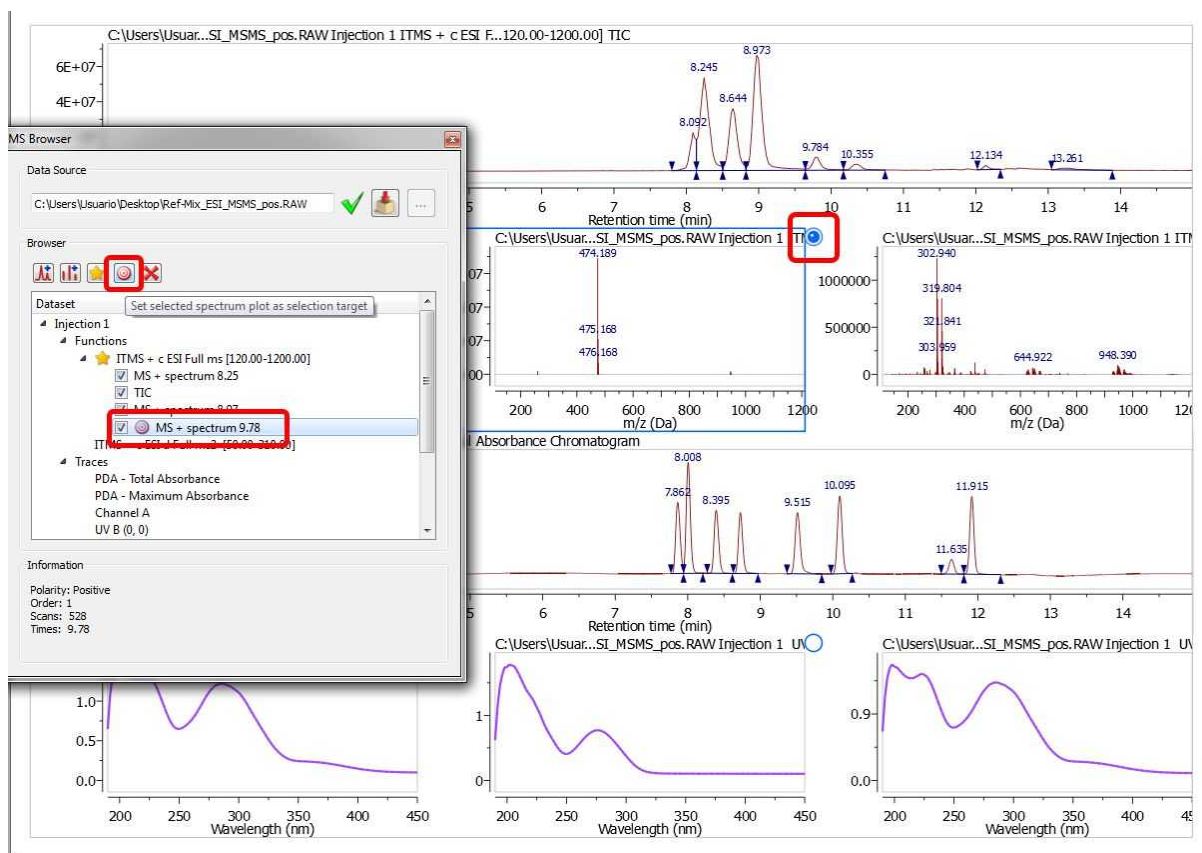

Set Tolerance: From this dialog box, you can select the tolerance (in Da or ppm) of the spectrum selection mode.

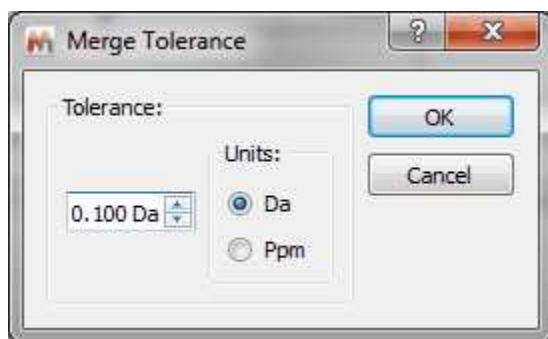

Merged tolerance is a m/z tolerance used any time mass spectra are summed or subtracted. The tolerance is applied to m/z values. Thus a merge tolerance of 0.1 Da means that if two spectra being summed contain, respectively, m/z 100.100 and m/z 100.150, the two mass peaks will be logically summed, since they're within 0.1 Da. The resultant intensity is the simple sum; the resultant m/z value will be the intensity-weighted average of 100.100 and 100.150.

14.2.2.3 Elemental Composition

Elemental composition analysis is one of the most informative techniques in mass spectrometry. With appropriate mass spectral data, elemental composition can quite often determine the unambiguous elemental composition of a molecular ion.

This technique, however, only produces sensible results from high accuracy mass spectra. For ions less than or equal to m/z 200, a measured accurate mass within 5 ppm is often required to determine elemental composition. At higher m/z values, measured accurate mass values of significantly less than 5 ppm may be required.

The algorithm that is used exhaustively computes all possible combinations of elemental formulae subject to the constraints provided by the user (see below). In some cases, millions of possible formulae are evaluated, but because of the speed of the algorithm, this happens very quickly.

This feature will be very useful to calculate the elemental composition of one or more mass peaks of a spectrum, if the m/z values are of high accuracy, typically 5 ppm mass accuracy or better.

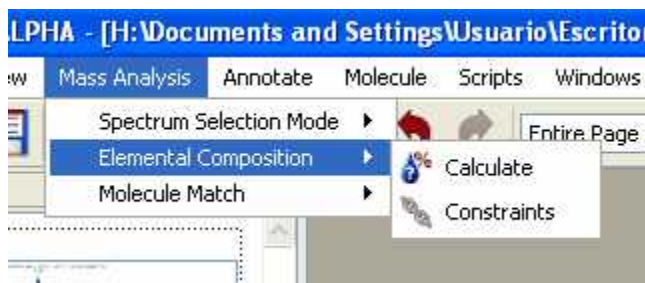

First of all, you should establish the constraints of the calculation, just by clicking on the corresponding option of the menu:

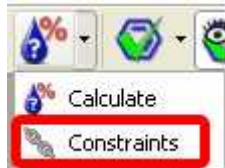

Clicking on 'Constraints' will display this dialog box:

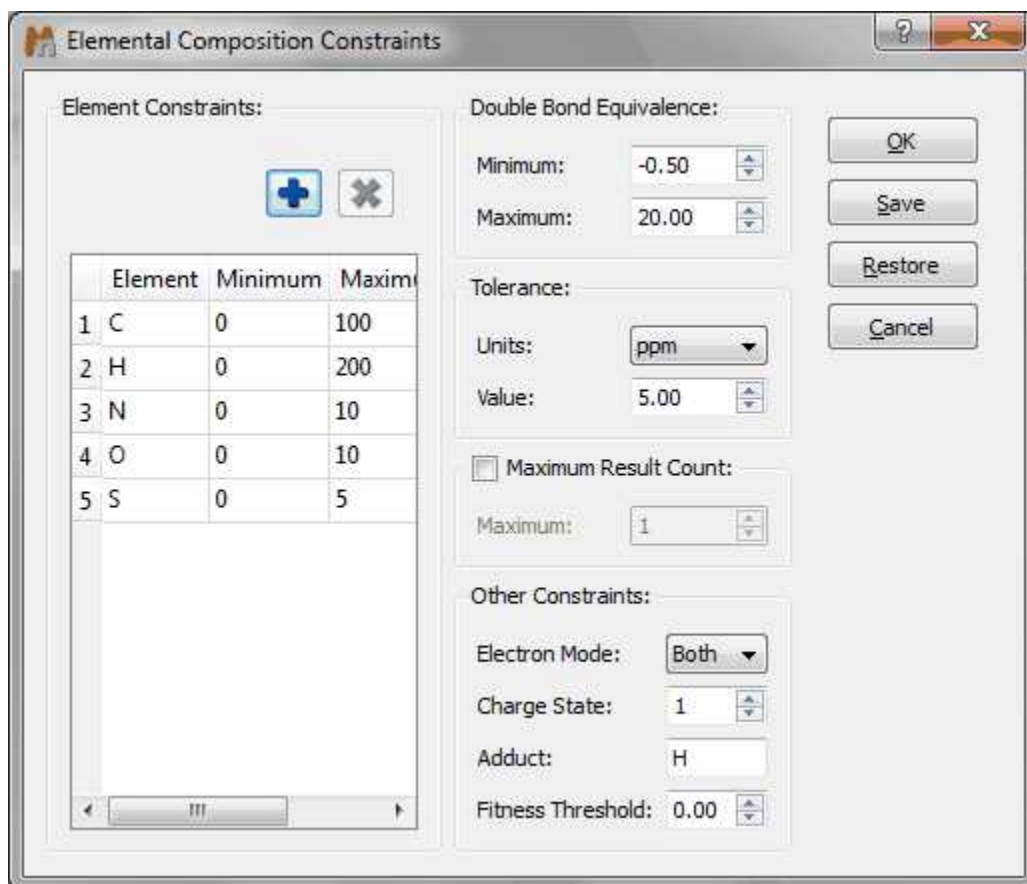

From the above dialog box, it will be possible to add more 'Element Constraints' just by clicking on this icon .

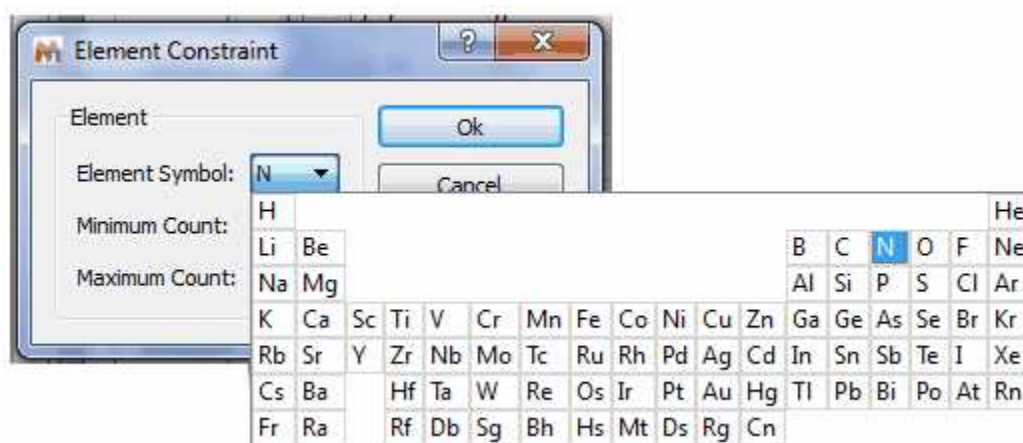

You can also select the 'Double Bond Equivalence', 'Tolerance', 'Maximum Result Count', 'Electron Mode', 'Charge State', 'Adduct' and Fitness Threshold'.

Double Bond Equivalence (DBE): Rings + double bonds

Tolerance: Tolerance for matching computed composition to the target m/z. If spectral mass accuracy is expressed in ppm, then the tolerance for matching should also be in ppm. The typical values in Da

should be 0.01 or less, or in ppm 5 or less. Tolerances much larger than this, generally give too many hits to be useful.

m/z: symbol used to denote the quantity, in units of Daltons (Da), formed by dividing the mass of an ion in unified atomic mass units by its charge number (regardless of sign).

Maximum Result Count: The maximum number of results to return.

Electron Mode: Electron mode can be even, odd, or both. Typically, EI (electron impact) produces positively charged, odd electron ions, whereas ESI (electrospray ionization) produces even-electron ions with either a positive or negative charge.

EI: Ionization of an atom or molecule by electrons that are typically accelerated to energies between 10 and 150 eV in order to remove one or more electrons from the molecule. The term electron impact is deprecated.

ESI: A process in which ionized species in the gas phase are produced from a solution via highly charged fine droplets, by means of spraying the solution from a narrow-bore needle tip at atmospheric pressure in the presence of a high electric field (1,000 to 10,000 V potential).

Charge State: is a signed value. The magnitude (1, 2, 3, ...) is a function of the experimental ionization technique, while the sign (+/-) is determined by the mode in which the experimental spectrum was produced and detected. For electron impact (EI) spectra, charge state is usually +1, while for ESI charge state is usually +1 or -1 for most organic compounds. Peptides may have higher charge states.

Adduct: Adducts are typically found in soft ionization techniques such as ESI. Proton (H) is most common for organic compounds, while H and/or Na (or other Group 1A alkali metal cation) may be found in protein, peptide or polymer spectra. NOTE: If an adduct is specified, the mass (* charge state) is subtracted from the target mass before compositions are computed. The composition calculation assumes a neutral (uncharged, non-adducted) mass.

Fitness Threshold: Results that match the other criteria but have fitness lower than this threshold will be discarded. Fitness ranges from 0.0 (no match to experimental spectrum) and 1.0 (perfect match).

Once you have finished with the constraints, click on the 'Elemental Composition' icon  and select with the crosshair the desired peak of the Mass spectrum. A table with the results will be displayed (it is also possible to find this table under the 'View/Tables' menu). All the results obtained will satisfy the composition, DBE, and tolerance constraints, and will be ranked in decreasing order of fitness. Please bear in mind that a fitness value of 1 will be the perfect match.

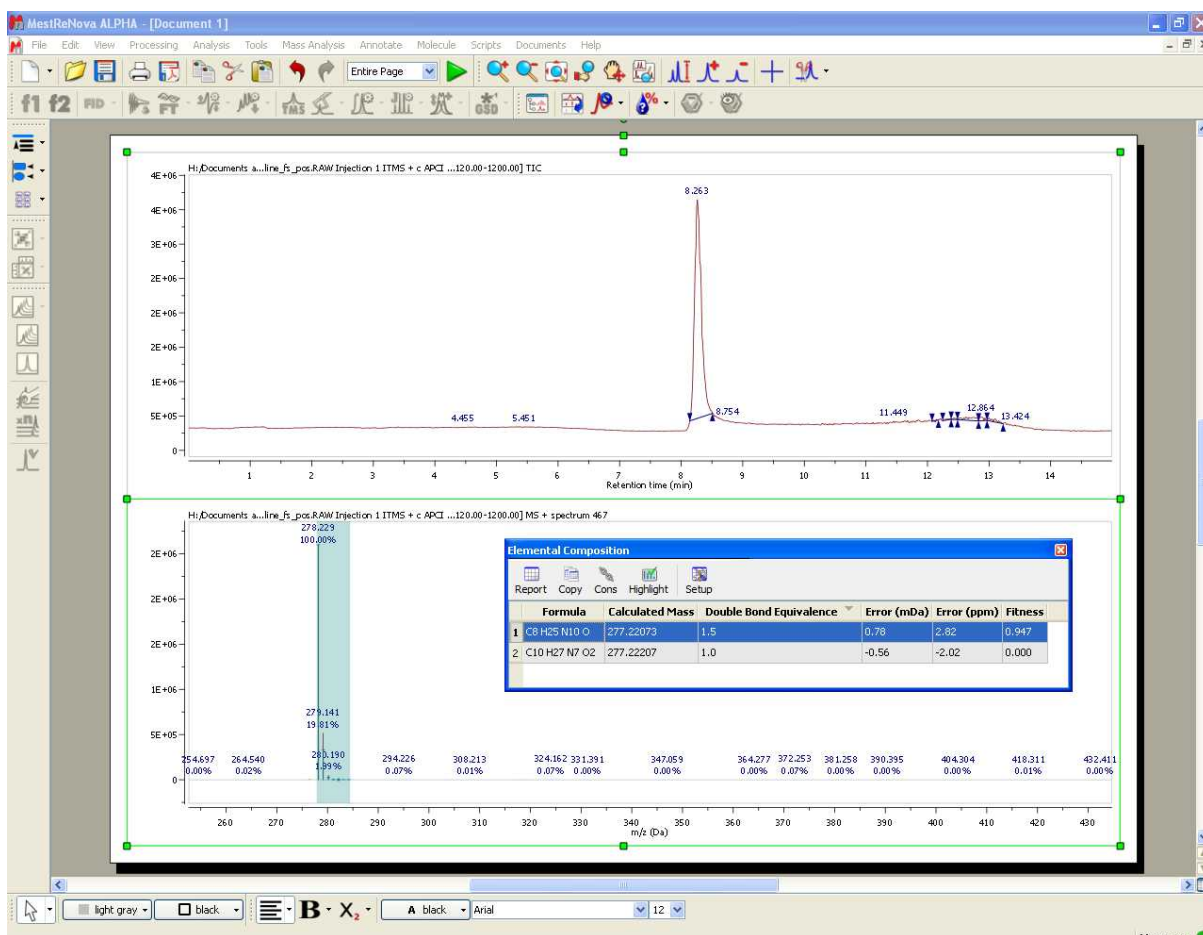

It will be possible to remove the highlighted area just by clicking on the applicable button of the Elemental Composition table.

Please bear in mind that mass spectrometers measure monoisotopic m/z values which is different with the Molecular weight value (calculated using the average mass of each element weighted for its natural isotopic abundance). For example, for C₂₀H₂₃N, the chemical mw is 277.402, and monoisotopic mw is 277.182. Here you can see a list of the exact mass of some elements:

Element	Symbol	Exact Mass
Hydrogen	H	1.00783
	2H (D)	2.0141
Carbon	12C	12
	13C	13.0034
	14C	14.0031
Nitrogen	14N	14.0031
	15N	15.0001
Oxygen	16O	15.9949
	17O	16.9991
	18O	17.9992
Fluorine	F	18.9984
Silicon	28Si	27.9769

	29Si	28.9765
	30Si	29.9738
Phosphorus	P	30.9738
Sulphur	32S	31.9721
	33S	32.9715
	34S	33.9679
Chlorine	35Cl	34.9689
	37Cl	36.9659
Bromine	79Br	78.9183
	81Br	80.9163
Iodine	I	126.9045

14.2.2.4 Molecular Match

Molecule match analysis determines the possible presence of a given structure or structures within a mass spectral data set. The molecular ion cluster of each structure is computed and compared to each spectrum in the data set. If one or more spectra contain the computed isotope cluster within reasonable matching constraints, the most intense spectrum within the most closely matched chromatographic peak is returned as a positive result. Structures not matched are assigned a “not found” result. The constraints dialog allows the user to select one or more adducts, specify ion polarity, and other parameters.

The algorithm makes use of fast isotope cluster calculations and a sophisticated spectral matching technique.

Molecule match analysis is very general purpose. Applications include small molecule confirmation and metabolite identification.

Limitations are few but include the requirement that the acquired spectra of the compounds being analyzed exhibit at least partial molecular ion clusters.

The 'Molecule Match' is very useful to see if a mass spectrum and a GC chromatogram match with one of the molecular structures of the document.

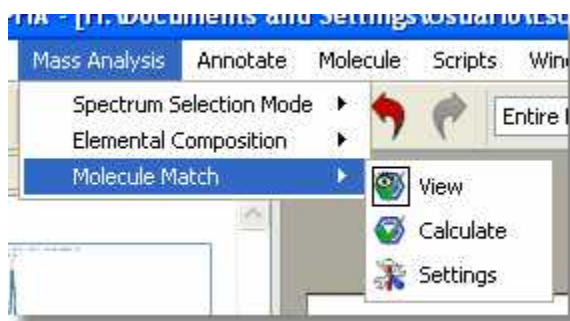

Just load your spectrum (TIC and MS) and paste the molecular structures into any page of the same document (or load whole spectral libraries by opening an sdf file). Next click on the 'Calculate Molecule Match' button of the toolbar  (or follow the menu 'Mass Analysis/Molecule Match/Calculate').

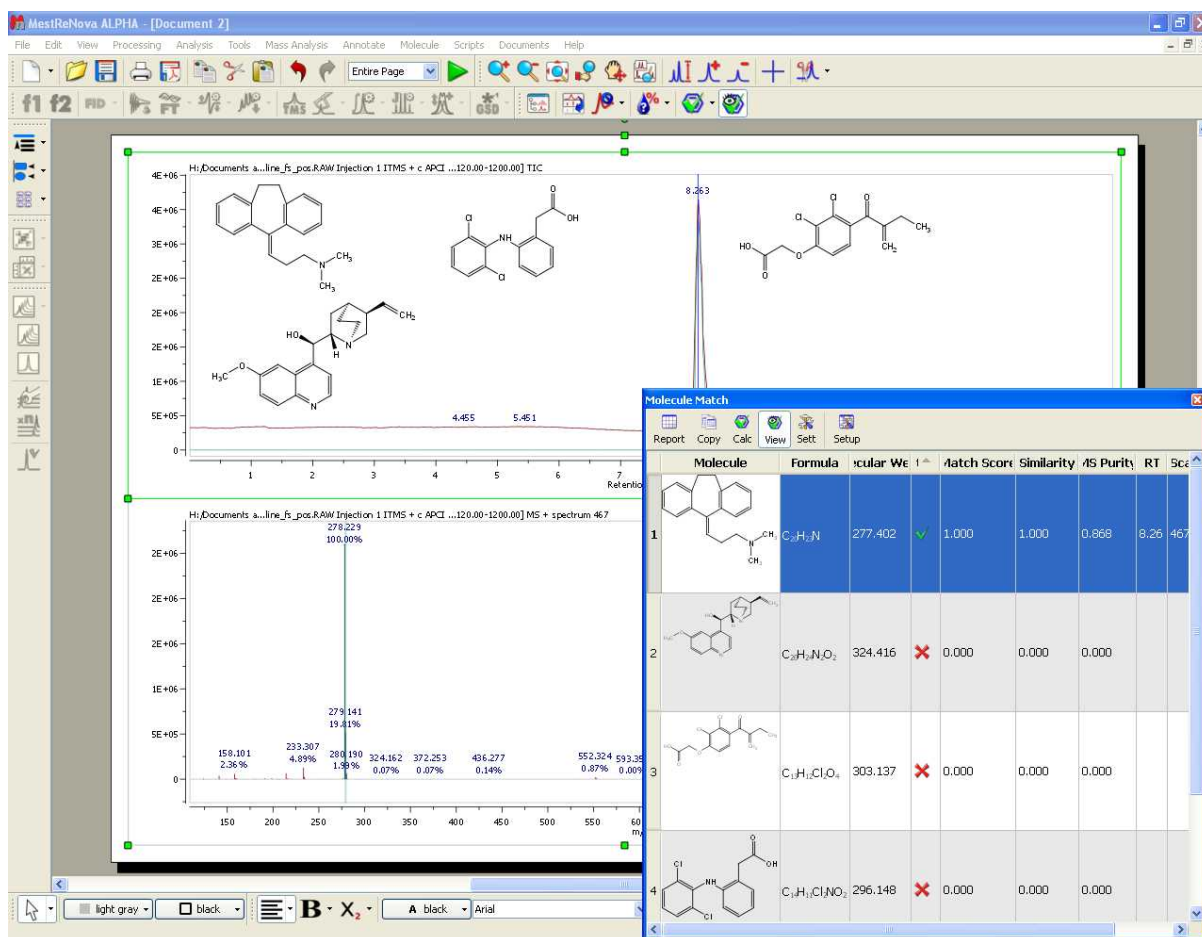

The 'Molecule Match' table with the results will be displayed (it will be also possible to find this table under the 'View/Tables' menu). This table will contain information about the 'Retention Time' (RT), Scan (number of spectrum), Match Score, Similarity, MS Purity, etc..

Similarity is the comparison of the computed isotope cluster spectrum of a given molecule's molecular formula, plus optional adduct - that is, the mass spectral peaks of the molecular ion - with the mass peaks of the acquired spectrum in that mass region. The similarity value can be from 0 to 1, and you will note that a threshold of 0.8 is used. For instance, a pesticide named Pydrin, with a molecular formula of C₂₅H₂₂NO₃Cl, plus an adduct of H, has an isotope cluster of 420.137 - 100%, 421.140 - 28%, 422.135 - 36%, 423.137 - 10%, 424.140 1.5%. This is compared with the mass peaks of the acquired spectrum in the mass range of about 420 to 425.

Match Score is the product of Similarity and MICC value (see below).

MICC is molecular isotope-cluster chromatogram. Which is the sum of mass chromatograms of all the significant peaks in the isotope cluster. Using the example above, m/z 420.137 + 421.140, and so on.

This is almost the same as the mass chromatogram, across several Daltons, in the case listed above, from m/z 420 425. The reason it is not the same is that for accurately measured mass spectral data, a small tolerance on the order of a few ppm might be used for matching.

For any given molecule, the MICC chromatogram is normalized to 1.0, and this value is what is used for Match score above.

MS Purity is the proportion of the total intensity of the mass peaks matched in the Similarity measurement relative to the total intensity of the whole spectrum. MS Purity is then, the fraction of the found molecular ion intensity versus the total intensity of the spectrum. This assumes that most of the intensity of the whole spectrum will be due to the molecular ion cluster, which is true for soft ionization mass spectra, which is true for most forms of ionization in use today. Which is not to be confused with MS/MS experiments, which have impart additional energy to produce fragmentation. So, using the MS purity as a metric generally provides a useful value that is a larger value with "pure" spectra, that is spectra without a lot of background (or overridden by the intensity of the molecular ion) or without a coelutant.

Purity is the ratio of the matched peak area (in the TIC) of the signals of matched compounds.

Clicking on any "matched molecule" will display the MICC (Molecular Isotope Cluster Chromatogram), overlaid with the TIC. The MICC shows the summed response of the isotope cluster for each MS spectrum over the entire data set. The MICC is the sum of the mass chromatograms of each m/z value of an isotope cluster.

In this example, the best result was for the compound number 1 (C₂₀H₂₃N). You can see in the picture below the MICC (in green) over the TIC (in red):

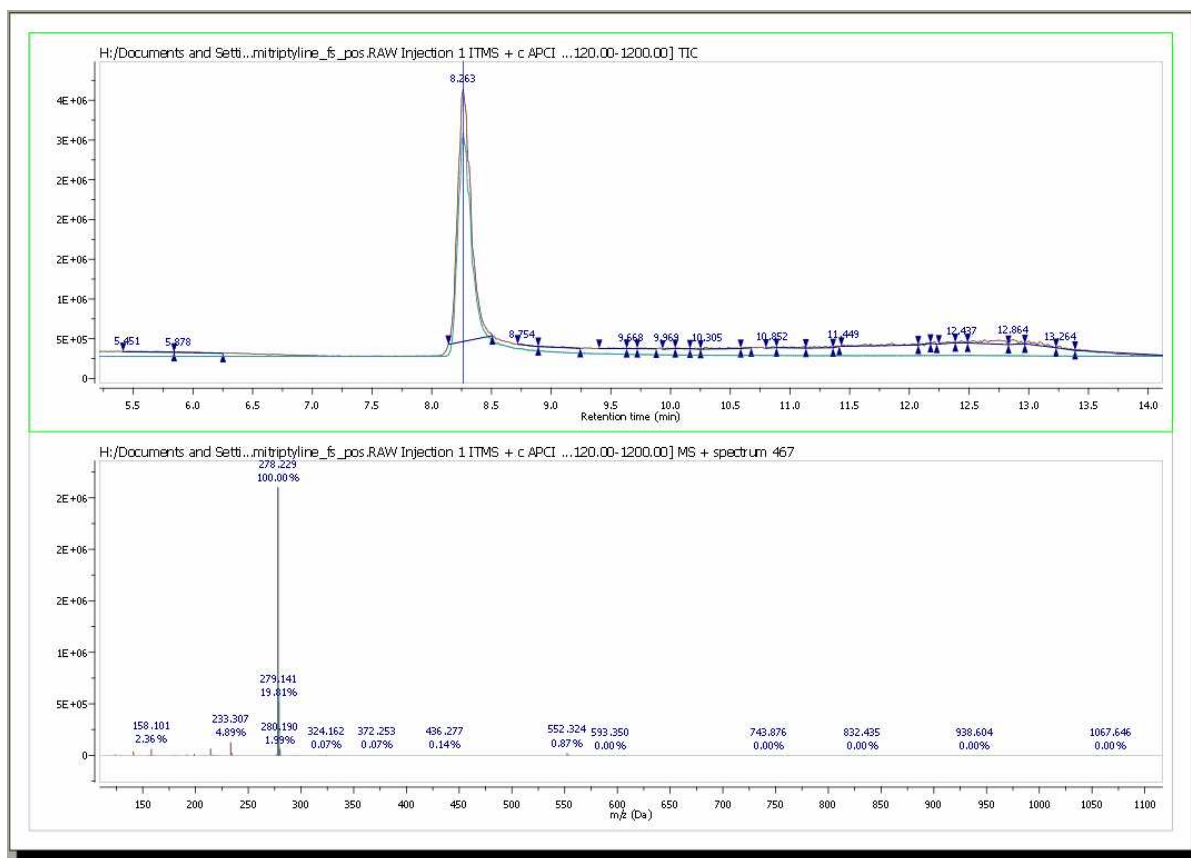

In addition, Mnova shows you in the chromatogram the retention time of the match (with a blue vertical line) and displays the corresponding MS spectrum (the number 467 in this case) overlaid with the theoretical one (in green at a M/Z around 278, in this case). It is possible to show/hide the MICC and the theoretic MS just by clicking on the 'View Molecular Match' icon .

Here you can see another example, where the compound 8 (amitriptyline) is present in the mixture:

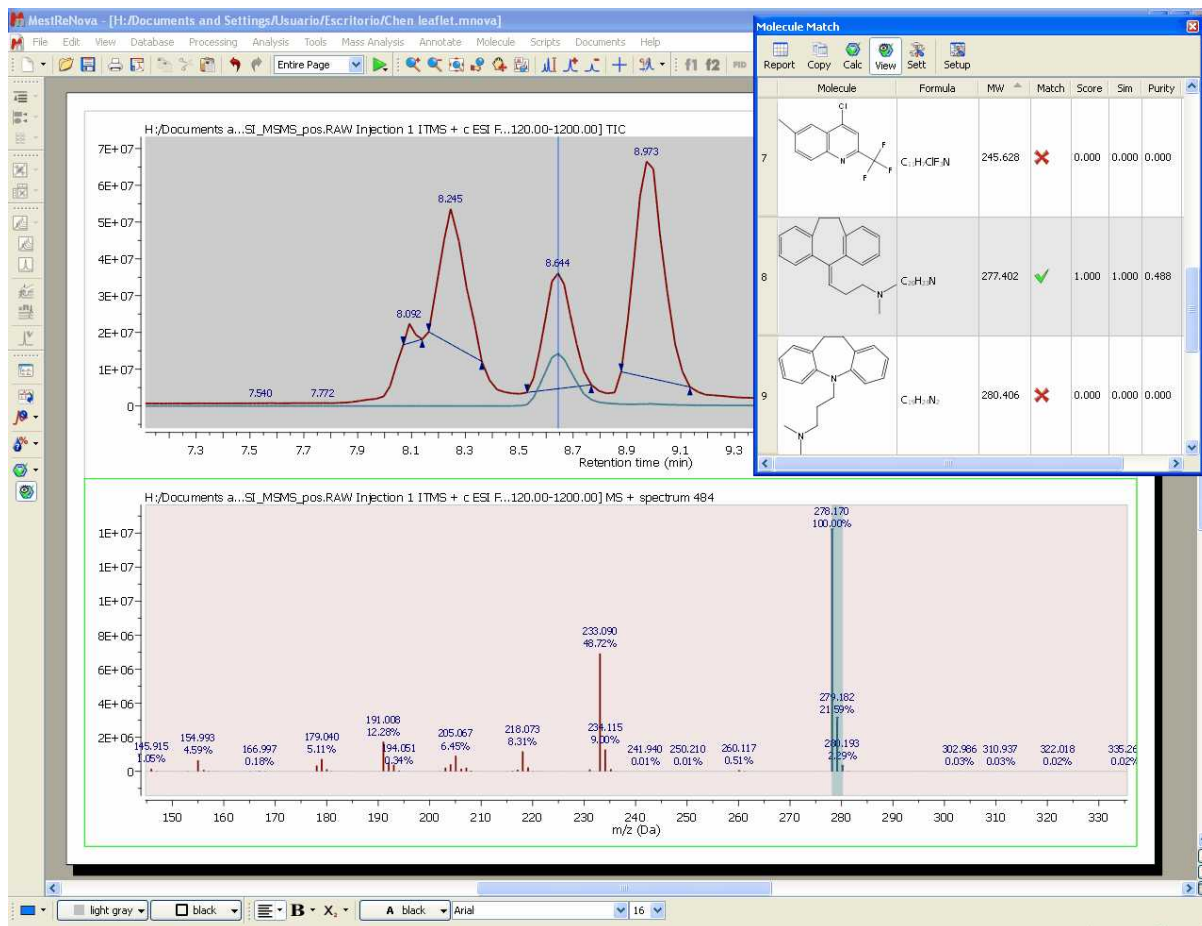

It is also possible to run a Molecular Match with a MS/MS spectrum and see the result directly in the MS/MS. Here you can see an example:

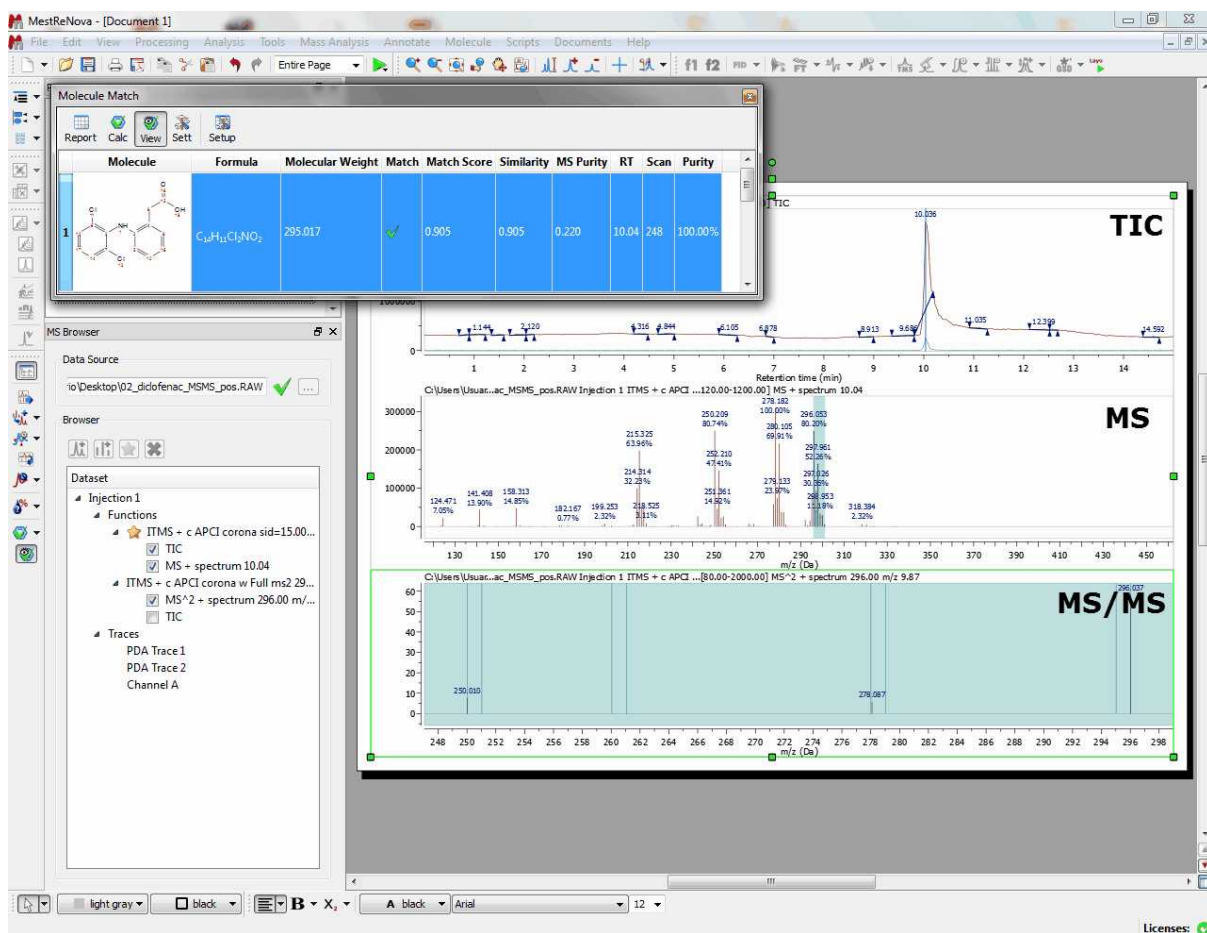

The user can also run the 'Molecular Match' feature just by entering a molecular formula after having clicked on the 'Calculate From Molecular Formula' in the applicable scroll down menu:

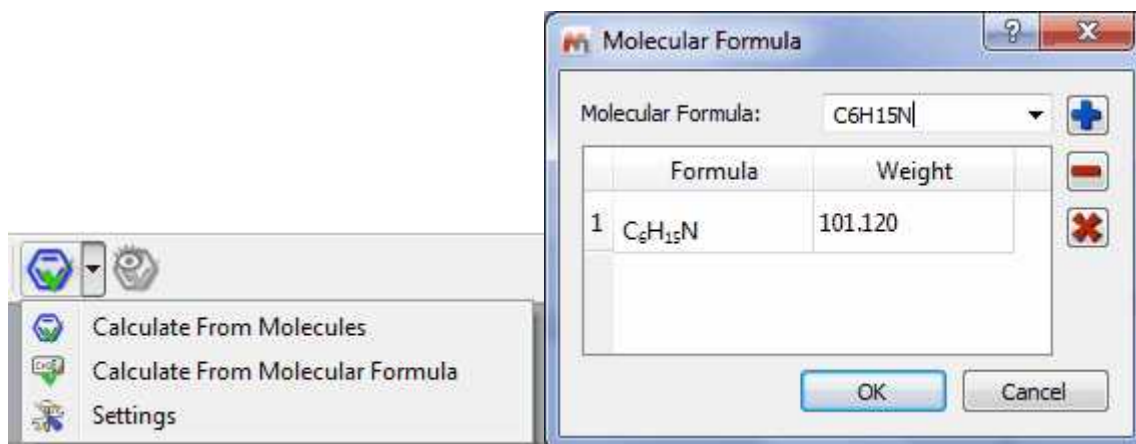

It will be possible to set the 'Molecular Match' settings just by selecting 'Settings' on the 'Mass Analysis/ Molecule Match' menu (or under the Molecule Match scroll down menu).

This will display the 'Molecule Match Settings' dialog box:

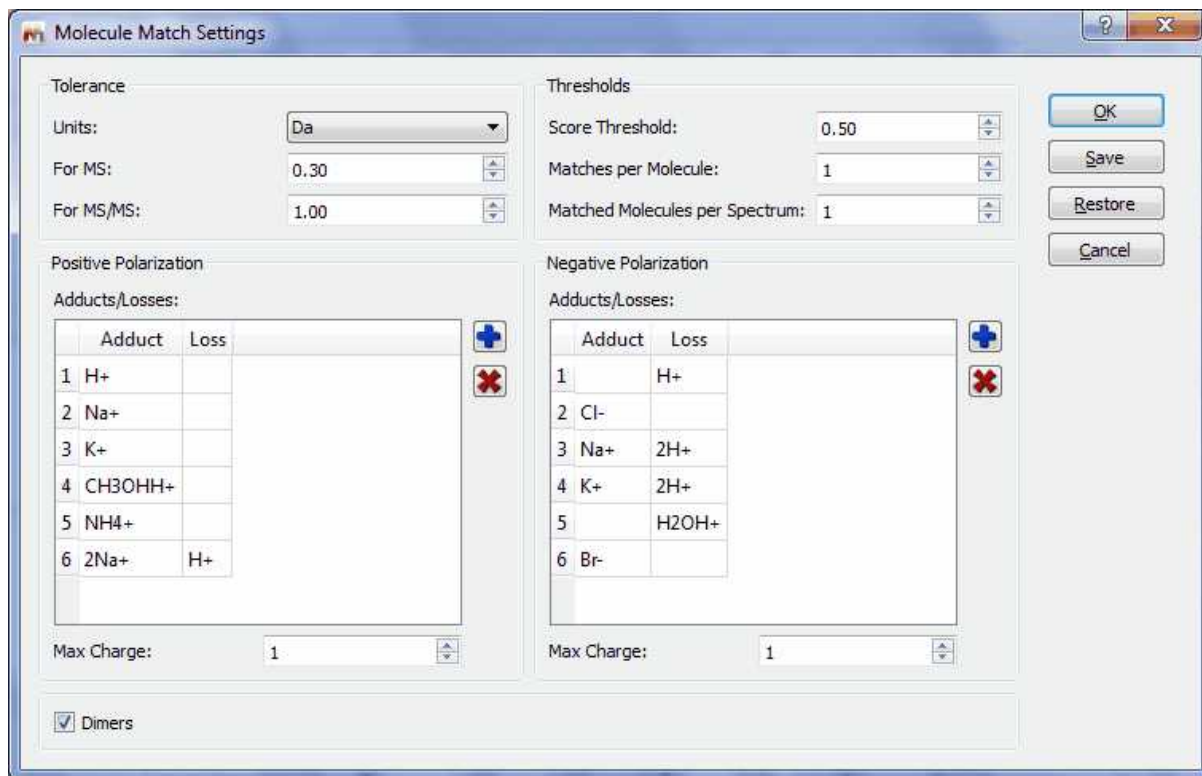

Tolerance: To set the m/z tolerance for matching predicted spectra to experimental; by default, MS spectra are matched to either 5 ppm or 0.5 Da, and MS/MS to 10 ppm or 1.0 Da, depending on whether the spectra are derived from high or low resolution instruments.

Thresholds: Set match score threshold for acceptable result; in most cases the default value of 0.5 is more than enough, however for weak / noisy spectra, the threshold may be lowered.

Matches per molecule: To set the maximum number of results per molecule; by default, a molecule is allowed to match only once, in which case the best result is returned. However, if no MS/MS spectra are available and the sample is known to contain isomers, then increasing this limit will allow the molecule to match every isomer peak.

Matches per spectrum: Set maximum number of molecules allowed to match a spectrum; by default, each spectrum (or set of related spectra) is allowed to match only one molecule. However, if isomers are present in the molecule list, then allowing all matches may be desired.

Adducts: Set adduct/loss pairs using proper atomic or chemical formulas with charge notation.

Charges: Set maximum charge states to consider. By default, +/- 1 are the maxima.

Dimers: Set to enable consideration of dimers when matching; by default, dimer matching is disabled. A dimer (in this case) is a non-covalently bound molecule pair (e.g. bound by van der Waals, hydrogen bond, or electrostatic forces, not a covalent inter-atomic bond). If you have a molecule M, then in ESI+ it normally gives an [M+H]⁺ ion. If it forms a dimer in the ESI source, then the ion observed is [2M+H]⁺, and the m/z value we look for is twice the mass of M plus the mass of H.

14.2.2.5 New Mass chromatogram

It is very useful to extract a MS spectrum by following the menu 'Mass Analysis/New Mass Chromatogram' or by clicking on the corresponding icon of the toolbar:

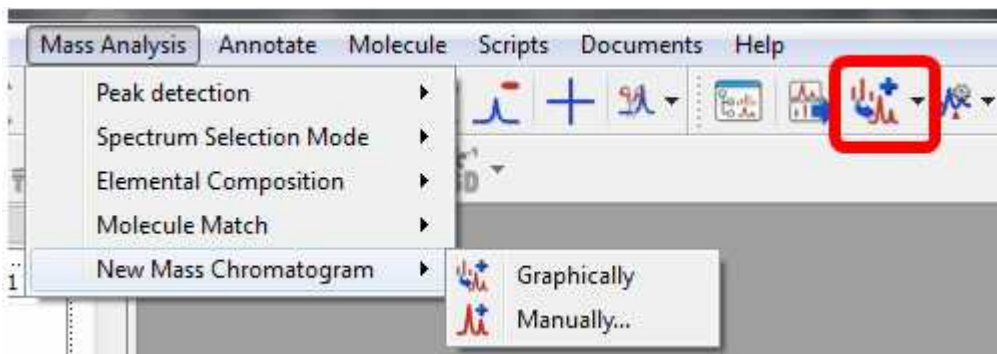

It is possible to extract the MS chromatogram **graphically** or **manually**. To extract the MS graphically, just select the option and click on the MS (or click and drag if you want to select a range):

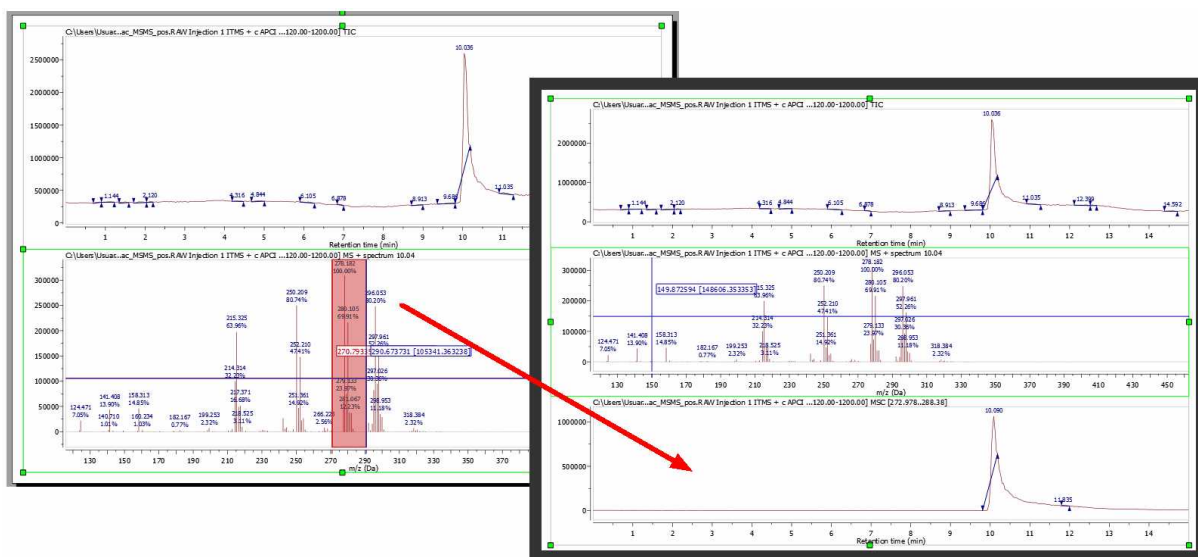

You can also select the range of the new chromatogram **manually**:

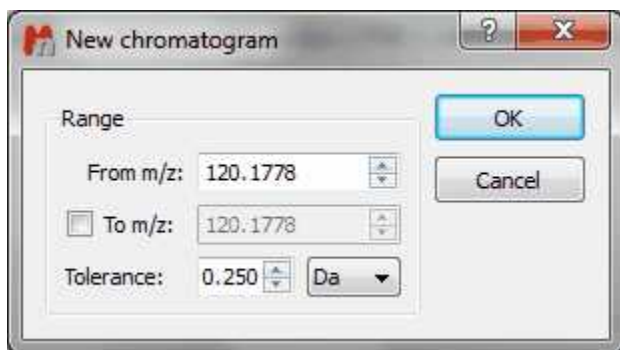

This also can be done from the MS Browser ('New chromatogram/Mass'):

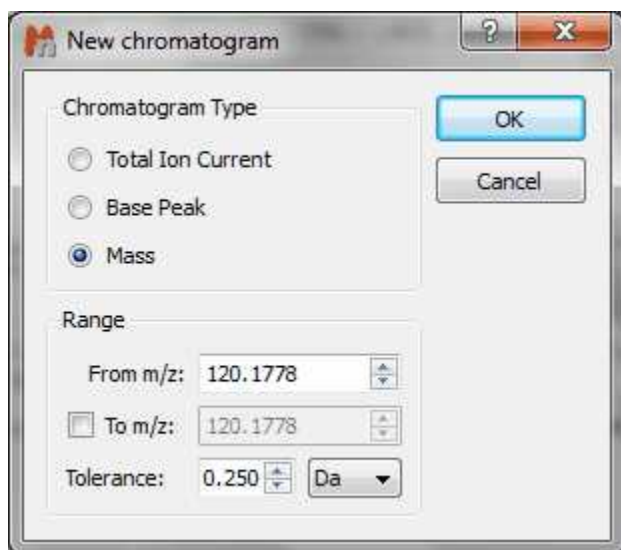

14.2.2.6 Reference External Traces

For some technical reasons, the TIC peaks can be delayed compared to the UV peaks. This feature will re-calibrate the chromatograms so that the peaks match across them. You will only need to clicks on a peak in the selected chromatogram and enter the new value to change the X scale (time).

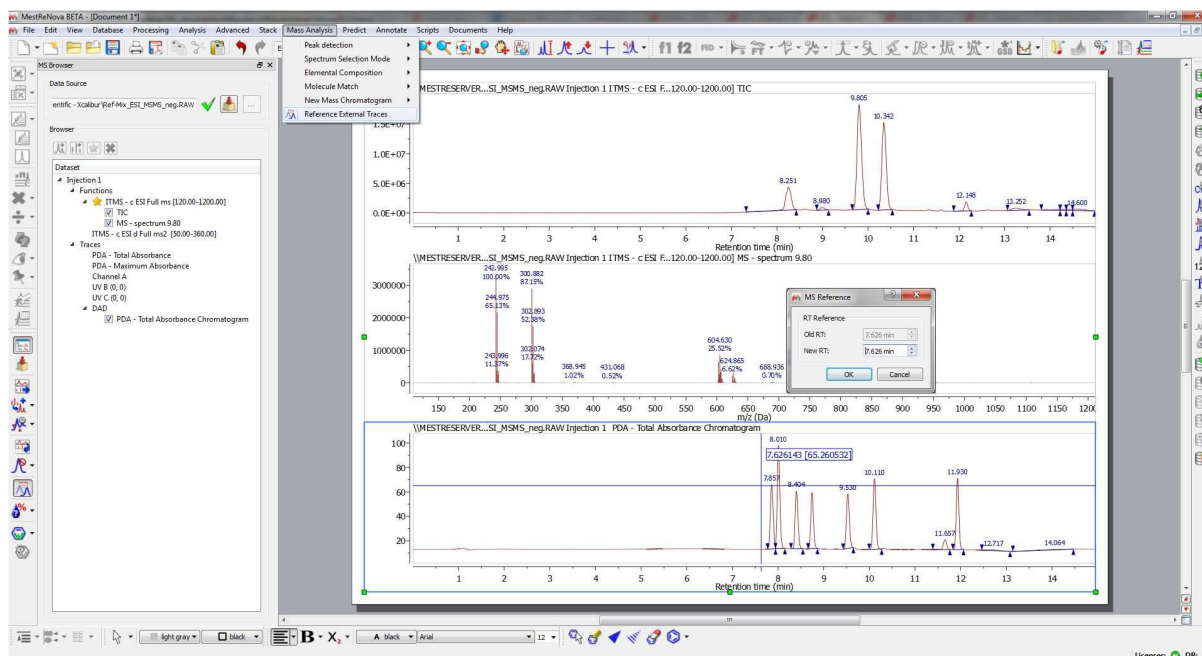

14.2.2.7 Background and UV subtraction

It will be possible to subtract chromatograms by scripting. This will allow users to subtract a blank background run from the run of interest, for example to ensure a good baseline for quantitation purposes, or to accurately measure differences between two or more runs.

Just follow the menu 'Scripts/Report/Chromatogram Subtraction' and select the folders containing the datasets (foreground and background) and the applicable path masks. Once the script has run, it will generate a report with information about the impurities found:

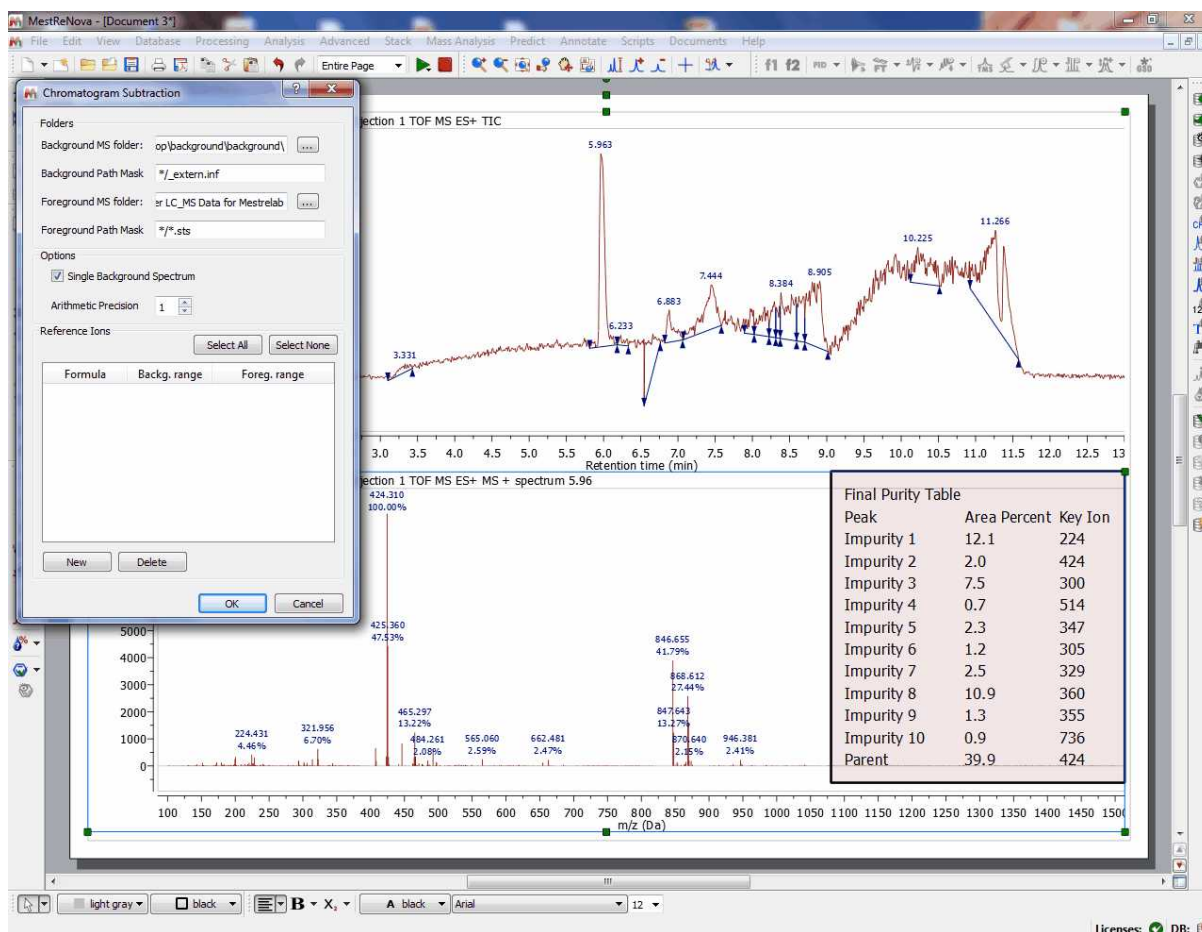

First thing the scripts does is subtraction of the Analysis chromatogram (foreground) minus the blank (background), this will give us the real chromatogram we are interested in, which will only show peaks which are not in the background chromatogram.

To do this subtraction, it is necessary to align the spectra, and this will be done by introducing known peaks at the beginning and end of the run (they will use compounds with certain known very short and very long retention times, which they will introduce in the sample). Finally in the resulted chromatogram, the scripts does a peak picking and integration, which will allow to identify impurity peaks (assumption is that this should be a pure compound, therefore the big peak is the compound, the others are impurities). The script continues until all impurities are check, and repeat process for every analysis chromatogram and its respective blanks. The script generates a Mnova document with the result in the Users folder and an output which is a set of tables as follows:

- Table with parent compound and impurities for analysis 1, with retention times and relative areas, as well as with the key ions which identify the impurity or parent compound
- Same table for subsequent analysis (2, 3, 4, etc.)
- Summary purity table, with averages from all analysis for each one of the peaks

Similarly to chromatogram subtraction, there is another script for UV subtraction (under the 'Scripts/ Report/UV Subtraction' menu). So you will subtract a background UV chromatogram from a foreground one:

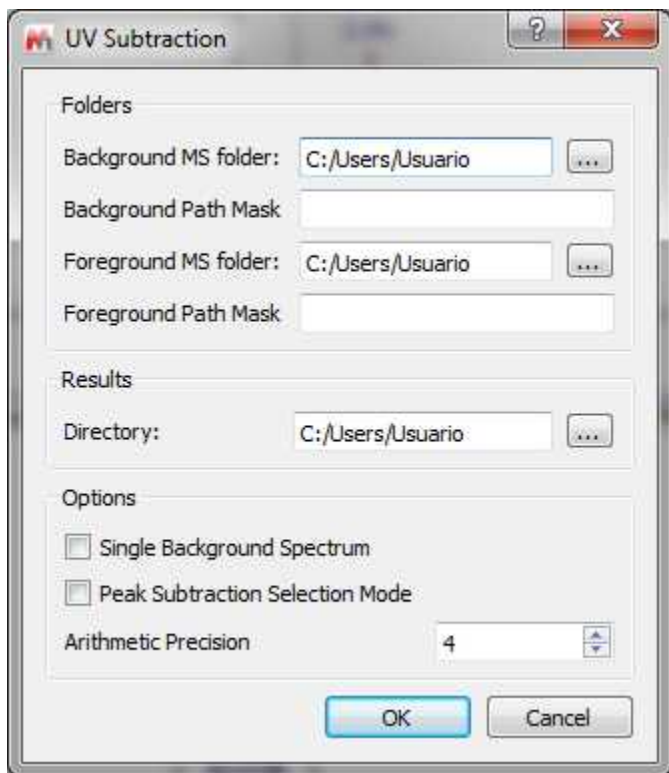

14.2.3 MS Peaks Table

You will find all the information about the peaks of your chromatograms and mass spectra by following the menu 'View/Tables/Mass Peaks' (or by right clicking on any toolbar and selecting 'Mass Peaks'):

You can see below an example of a 'Peaks Table' of a chromatogram; which includes information about the 'Retention Time', the number of the 'Scan', 'Type' (to describe peak ends. Possible values: 'Unknown', BB (Baseline to baseline), 'BV' (Baseline to valley); 'VB' (Valley to baseline); 'VV' (Valley to valley) and 'Shoulder'), 'Height', 'Area' 'Start and End Time':

	RT	Scan	Type	Height	Area	Total Height %	Total Area %	Start time	End time
1	14.600	709	VB	311755.386	3865292.127	0.72	1.81	14.529	14.956
2	14.443	700	VV	277872.176	2871082.085	0.64	1.34	14.355	14.529
3	14.286	691	VV	268608.253	1778055.206	0.62	0.83	14.237	14.355
4	14.202	687	VV	255163.880	932628.873	0.59	0.44	14.140	14.220
5	13.935	675	VV	171321.197	1148264.482	0.40	0.54	13.898	14.007
6	13.844	670	VV	155463.812	879709.497	0.36	0.41	13.808	13.898
7	13.577	659	VV	169826.278	1403073.413	0.39	0.66	13.541	13.753
8	13.252	641	VV	470147.815	6421264.905	1.09	3.00	13.066	13.523
9	12.876	627	VV	107815.178	939931.616	0.25	0.44	12.791	13.066

A table like the below one will be obtained in the case of a 'Mass' spectrum:



The screenshot shows a window titled "Mass Peaks" with a toolbar containing "Report", "Copy", and "Setup" buttons. Below the toolbar is a table with four columns: "m/z", "Intensity", and "Rel. Abundance". The table contains 12 rows of data, with the 125th peak highlighted in blue. The table is scrollable, as indicated by the vertical scrollbar on the right side.

	m/z	Intensity	Rel. Abundance
120	242.199	359.924	0.18
121	243.006	3021.458	1.51
122	244.086	431.711	0.22
123	245.008	3019.712	1.51
124	246.266	15926.770	7.95
125	247.020	200259.203	100.00
126	248.067	33786.750	16.87
127	249.021	71883.750	35.90
128	250.013	13517.686	6.75
129	251.013	2806.494	1.40
130	252.098	1653.903	0.83
131	252.991	561.074	0.28

The **Mnova GUI gives you much more**. Benefit from day one of many other Mnova capabilities, such as scripting, reporting templates, graphical annotations, multiple exporting formats, including PDF, OLE integration with MS Office and many, many more.

In the picture below you can see an example of a layout template used for the MS plugin:

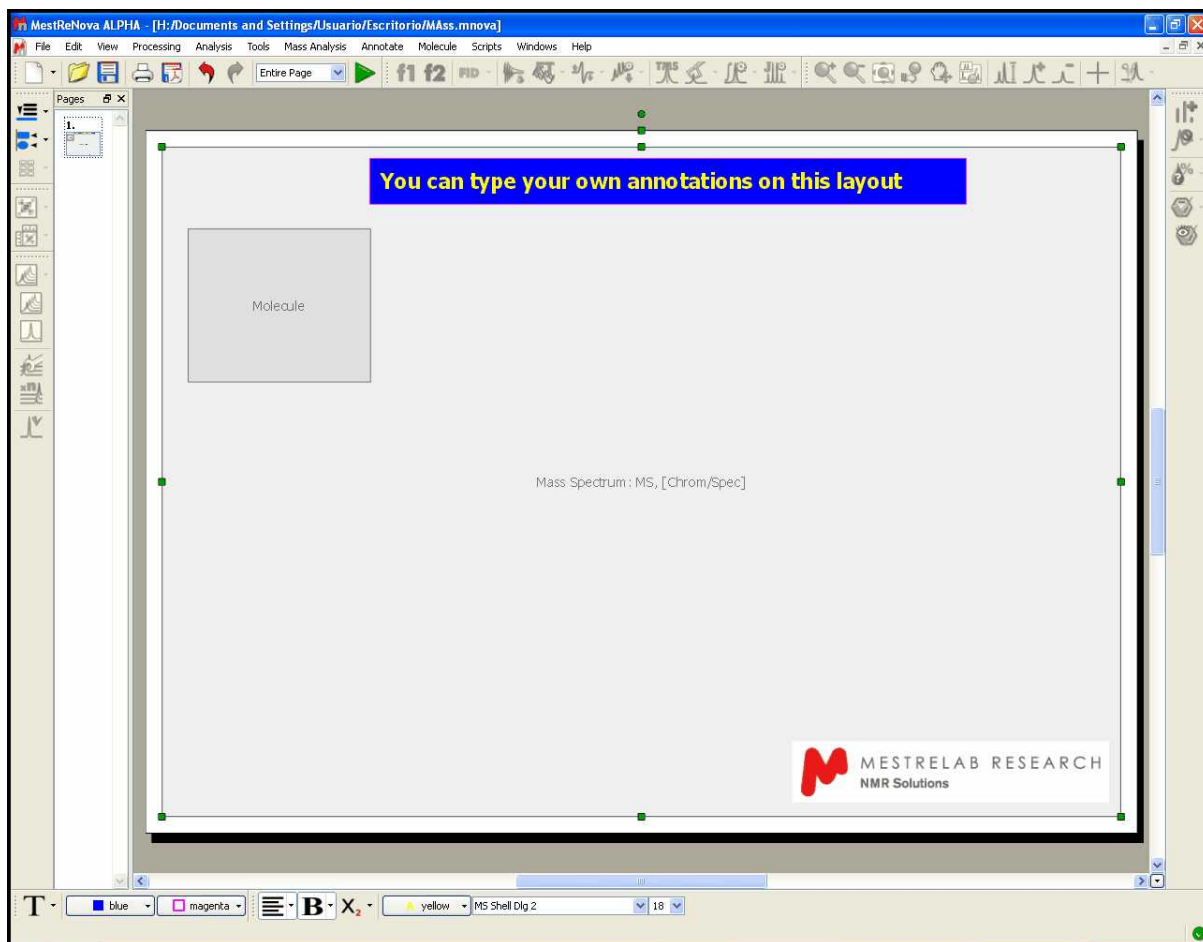

Mnova is an extremely versatile reporting tool, which will allow users to report even NMR and LC/GC/MS data together in the same document (or page):

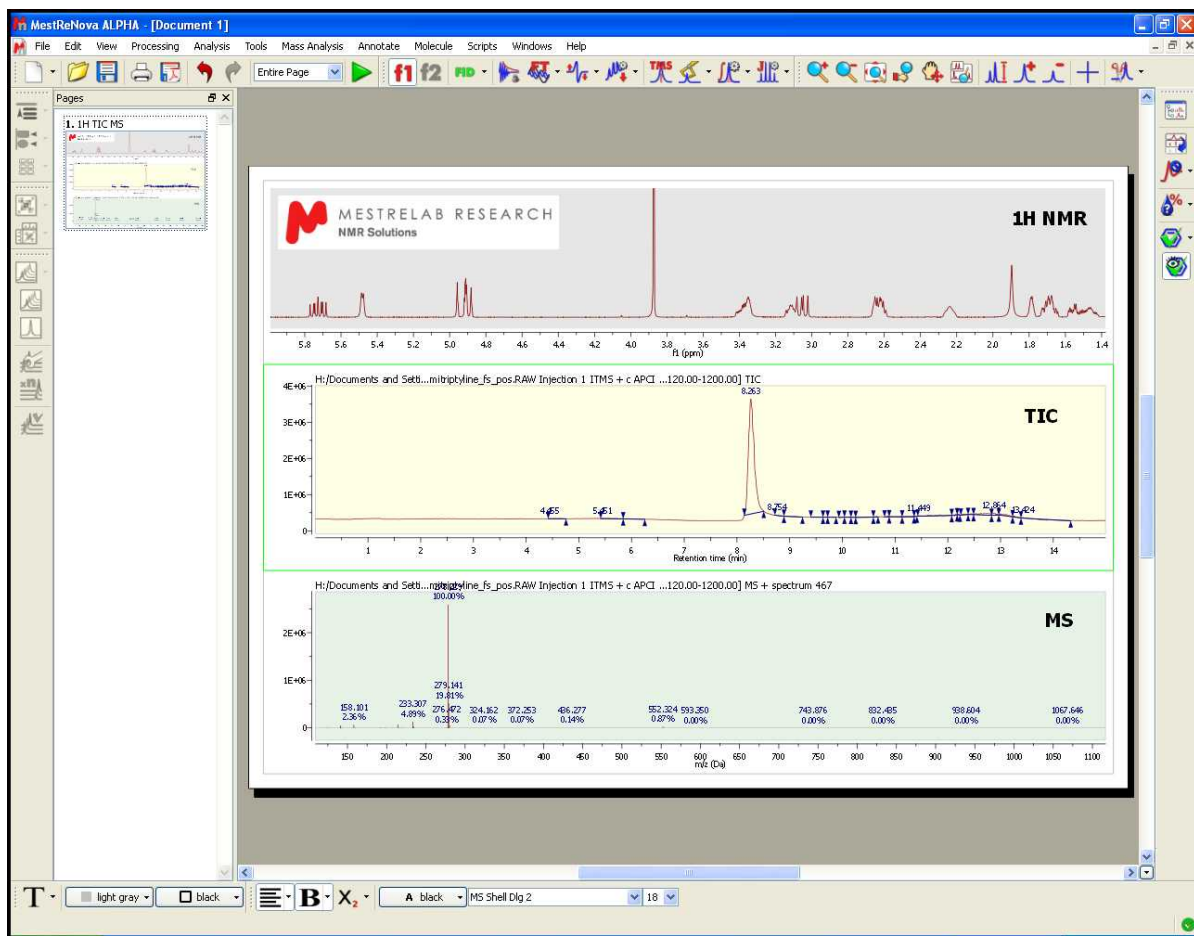

Here you can see another example with a MS and a 1H-NMR spectrum, containing a molecule structure and multiplet report:

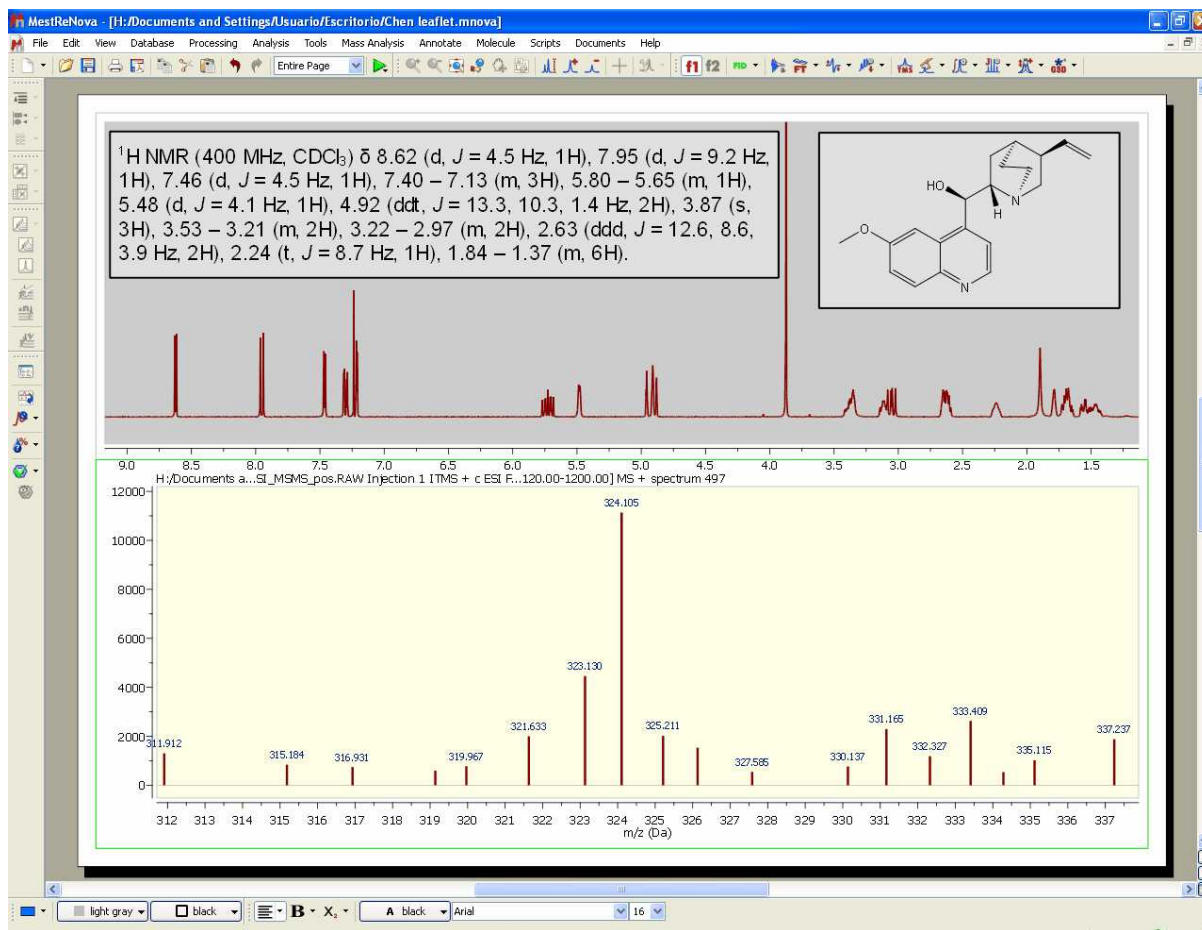

14.2.4 Context menu

You can access to the context menu just by right clicking on the spectral window:

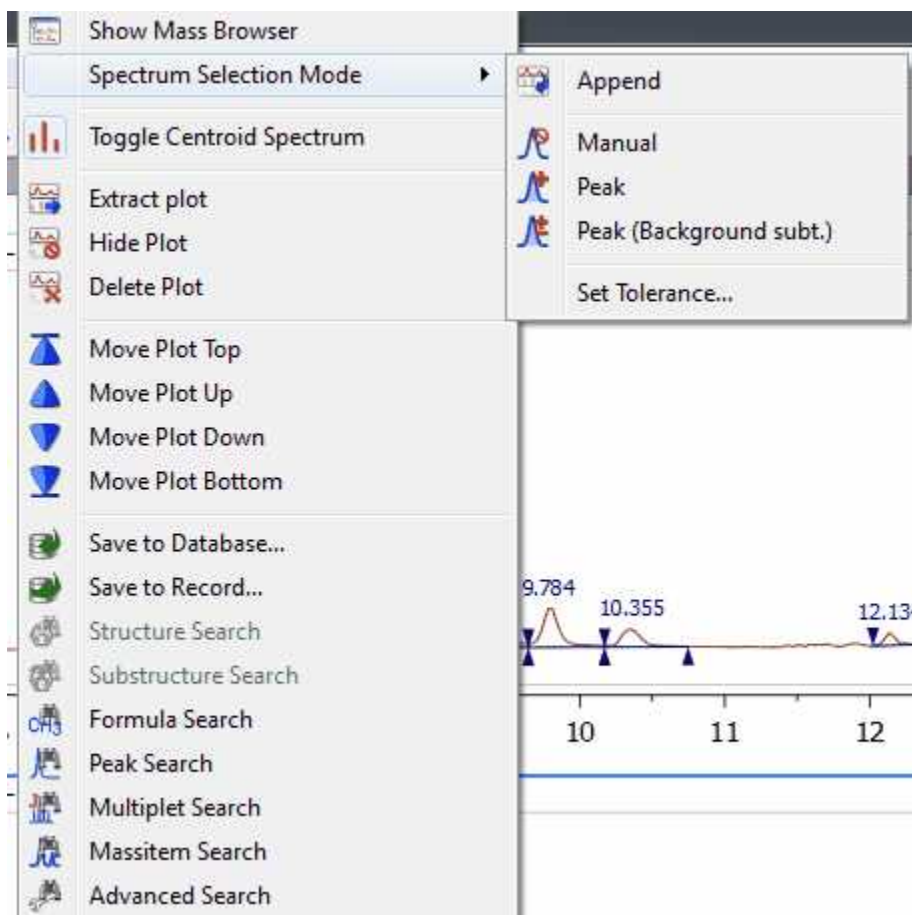

From here you can show the Mass Browser, select the spectrum selection mode, extract the active(s) plot to a new page and hide or delete the plots. It will be possible to select several chromatograms or spectra in the same page, for example to extract all of them to a new page. To do it, just hold down the 'Ctrl+Alt' key and click on the desired plots, next right click and select 'Extract plot'.

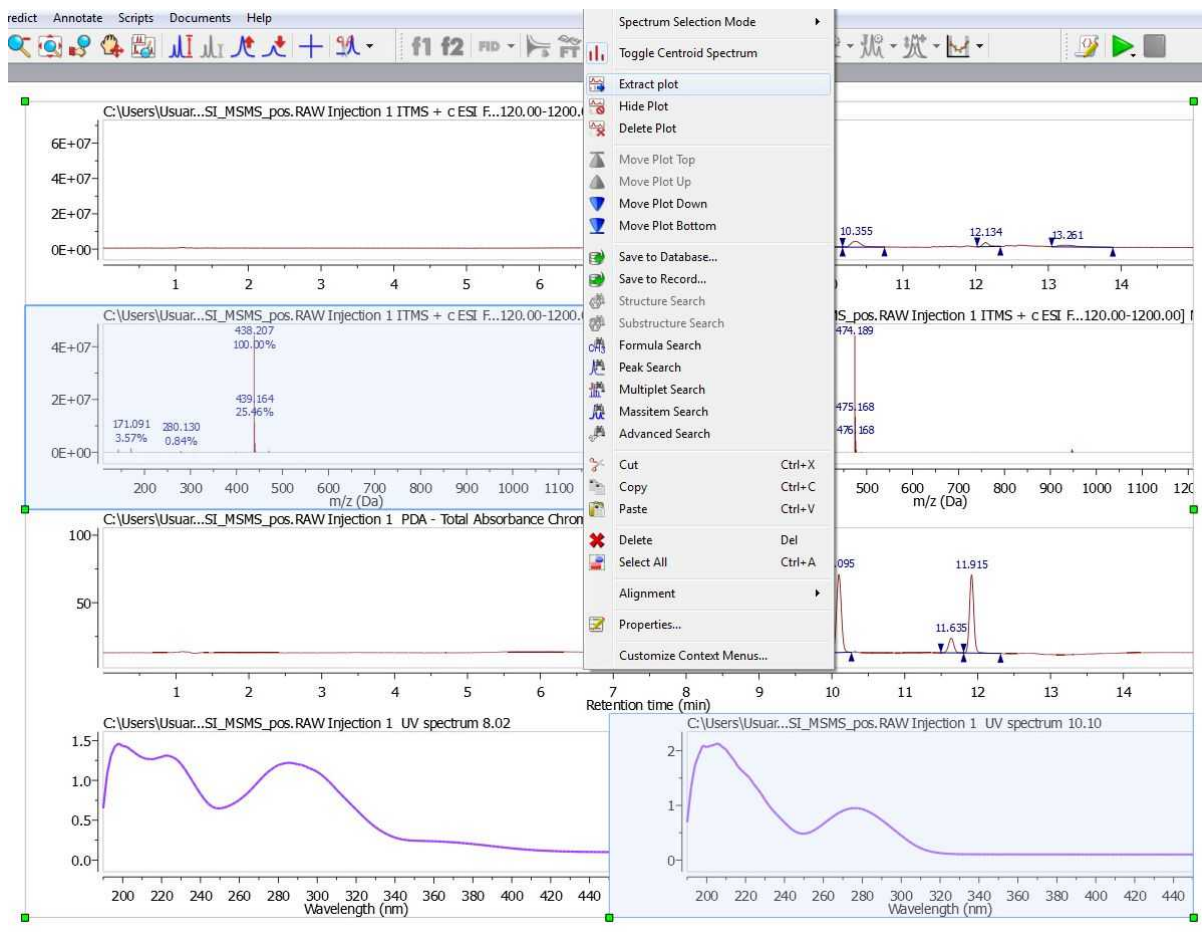

It is also possible to freely move up and down the plots just by right clicking on them and selecting the desired option (Move Plot Top, Up, Down or Bottom):

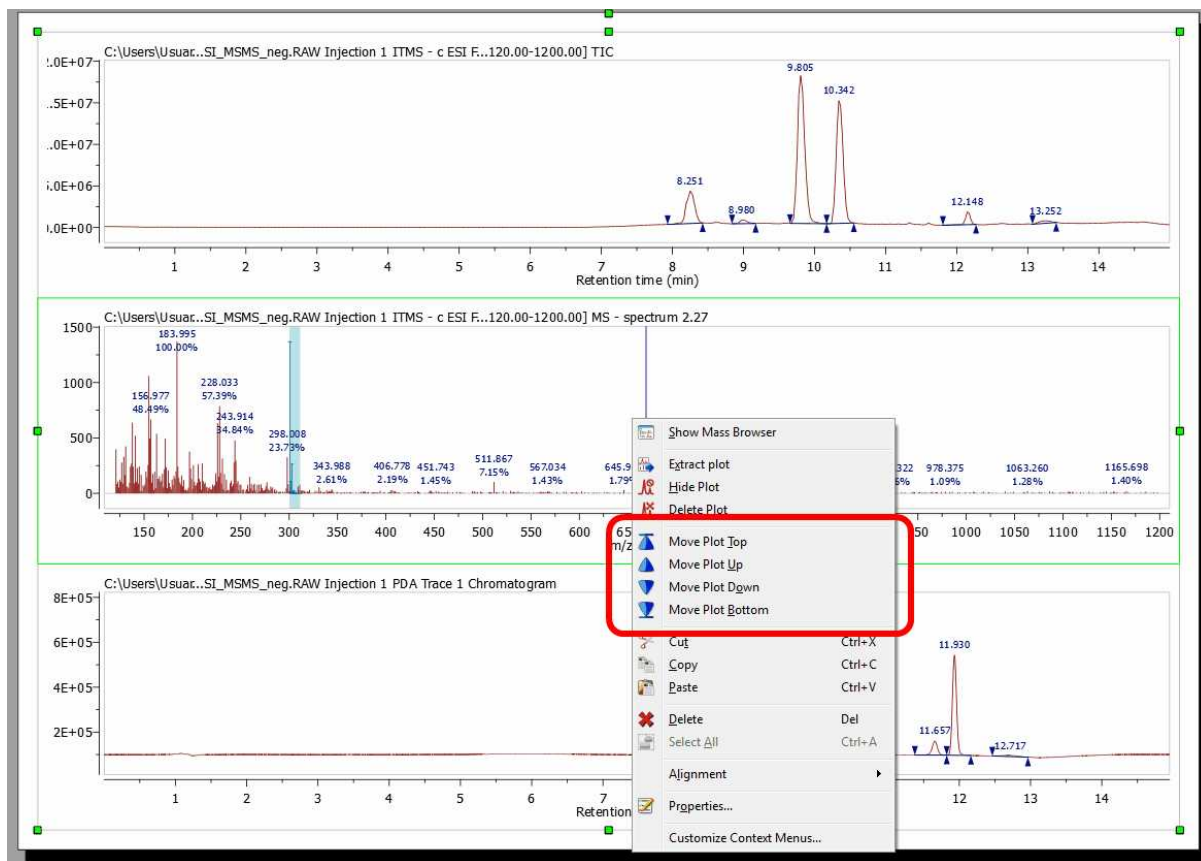

14.2.5 Properties

Mnova will allow the user to customize nearly all the attributes of the spectrum. The user can select the properties of the spectrum by following the menu 'Edit/Properties' or by double clicking the left mouse button or pressing the right mouse button on the spectrum display and selecting 'Properties' from the *pop-up* menu.

Double clicking on the spectral window will display the properties dialog box. From here you can modify the Line, Title, Peaks, Highlight, Axes and Basic properties of the TIC and MS spectrum by selecting the corresponding tab in the dialog box.

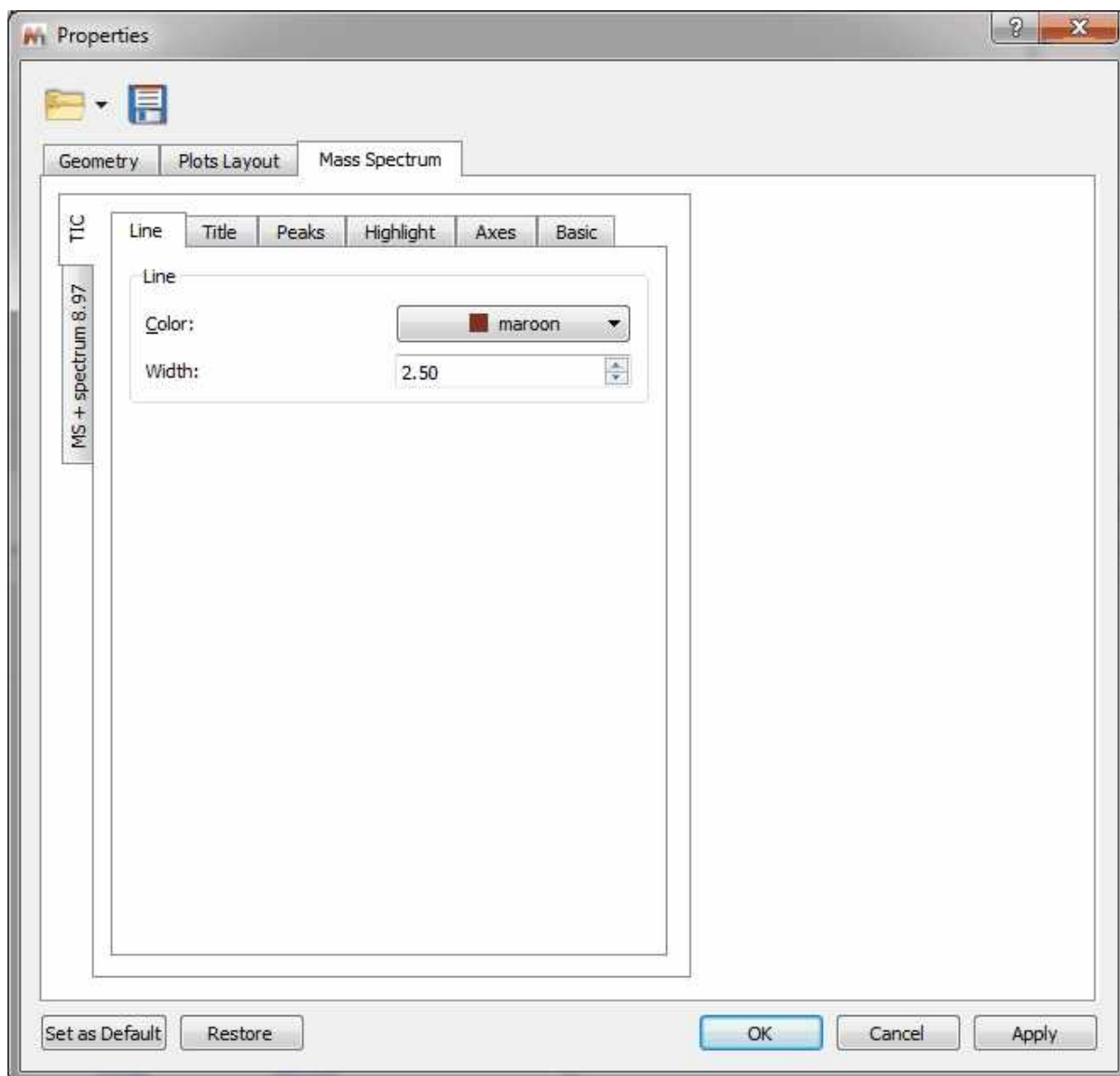

The majority of these properties are similar to [NMR spectral properties](#). The most important difference will be in the 'Plots Layout' and 'Peaks' tab.

Plot Layouts

You can see below the dialog box for the 'plots layout' properties:

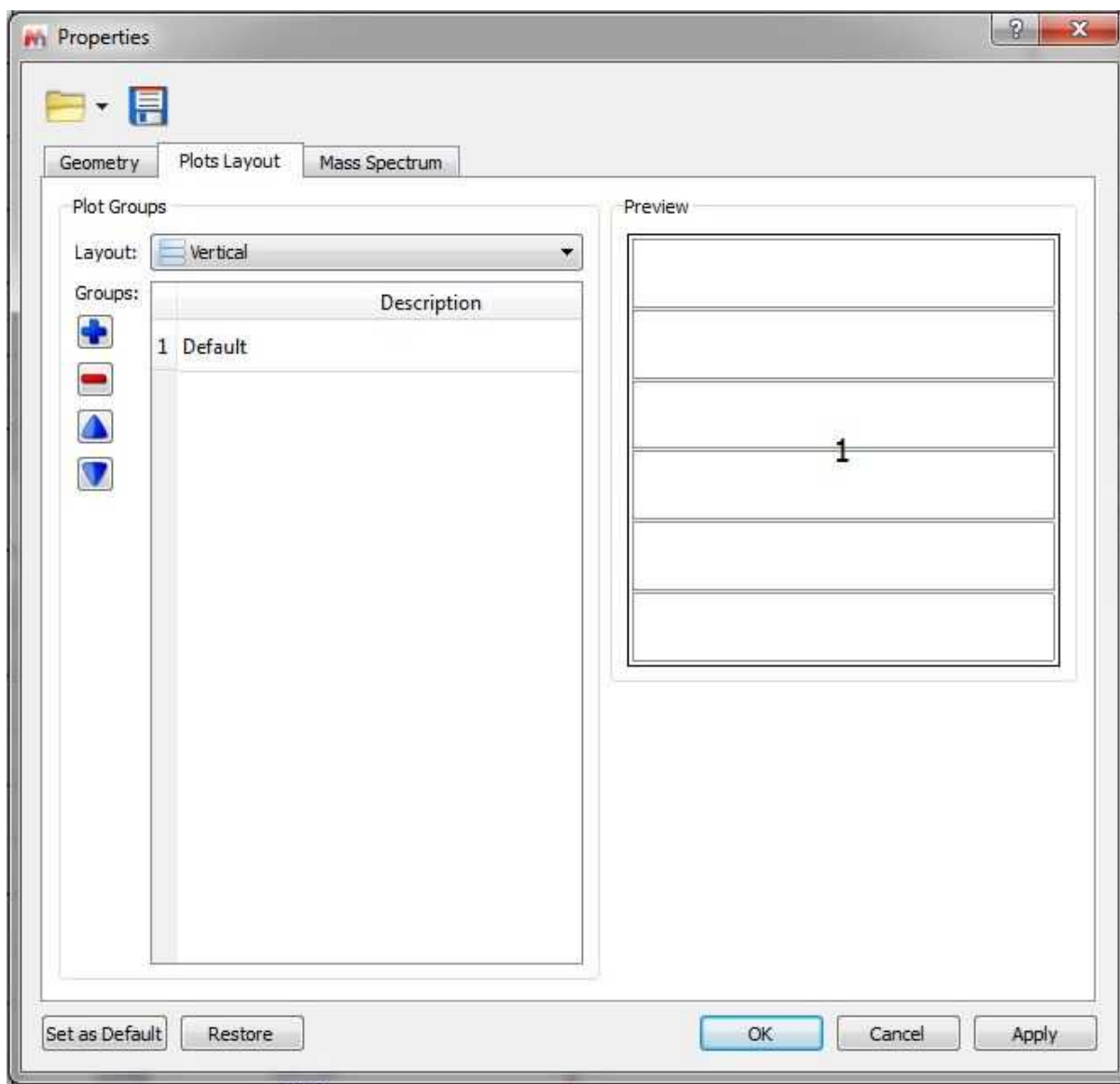

Clicking on the 'Add new group' button , will allow you to add another plot group. If you click on the new created group (called 'Any plot'), you will be able to select some settings (highlighted in red in the picture below):

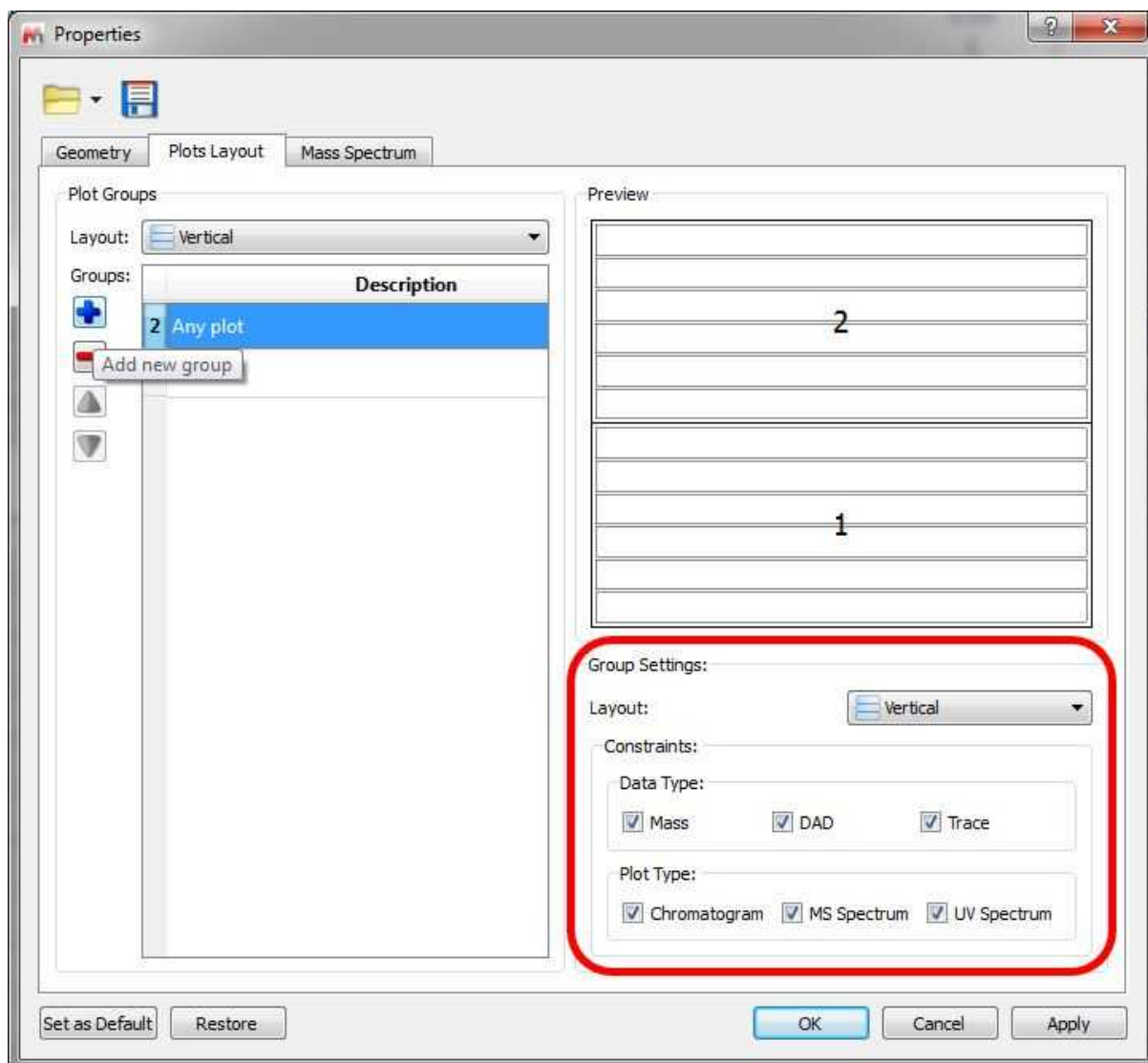

It will be possible to select the layout of the group (vertical, horizontal or grids) and several constraints about the Data Type (Mass, DAD or Traces) and Plot Type (Chromatogram, MS or UV spectrum). You can check the boxes for the applicable constraints or combine several options.

In the example below, it is shown how to create plot with 4 new groups. One group (number 5) for any Mass chromatogram plot (with any polarity or order), other group for any Mass spectrum plot with a horizontal layout (number 4), other group for any DAD chromatogram plot (number 3 with vertical layout) and another for any DAD spectrum plot (number 2; UV spectra with horizontal layout). The default group will be used in the case of any other object not present in the other groups.

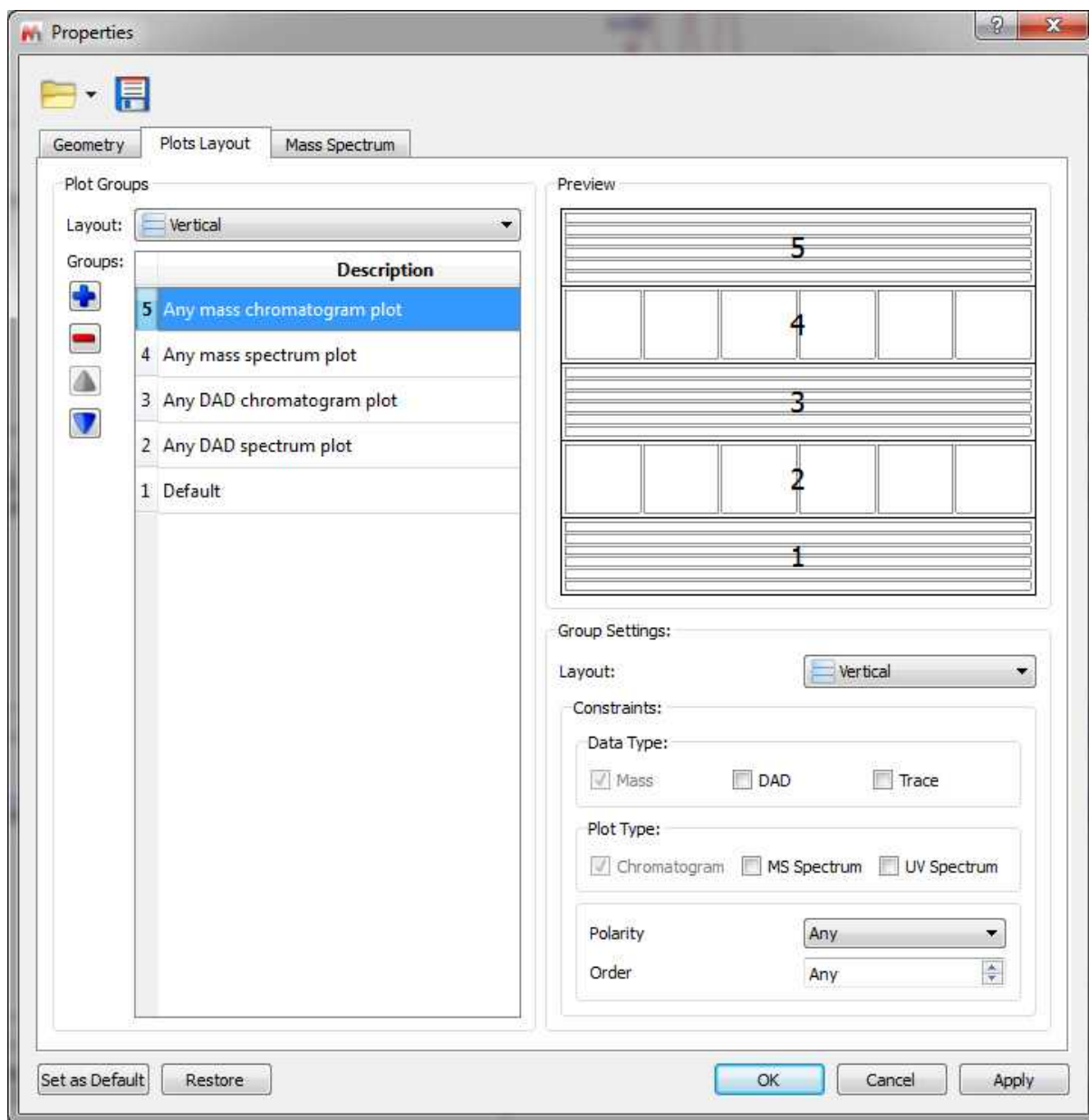

You can download the 'Property' file used above from [here](#). Next load it, by clicking on the 'Load' button of the 'Properties' dialog box and open a MS dataset. Use the [MS Browser](#) to display the DAD chromatogram and the [crosshair](#) to select the applicable MS or UV at a given retention time in the

chromatogram. To get the additional spectra, you will need to click on the '[Append](#)' button  of the toolbar.

Here you can see the result with the TIC on top followed by several MS spectra, the Total Absorbance Chromatogram (as a DAD) and several UV spectra:

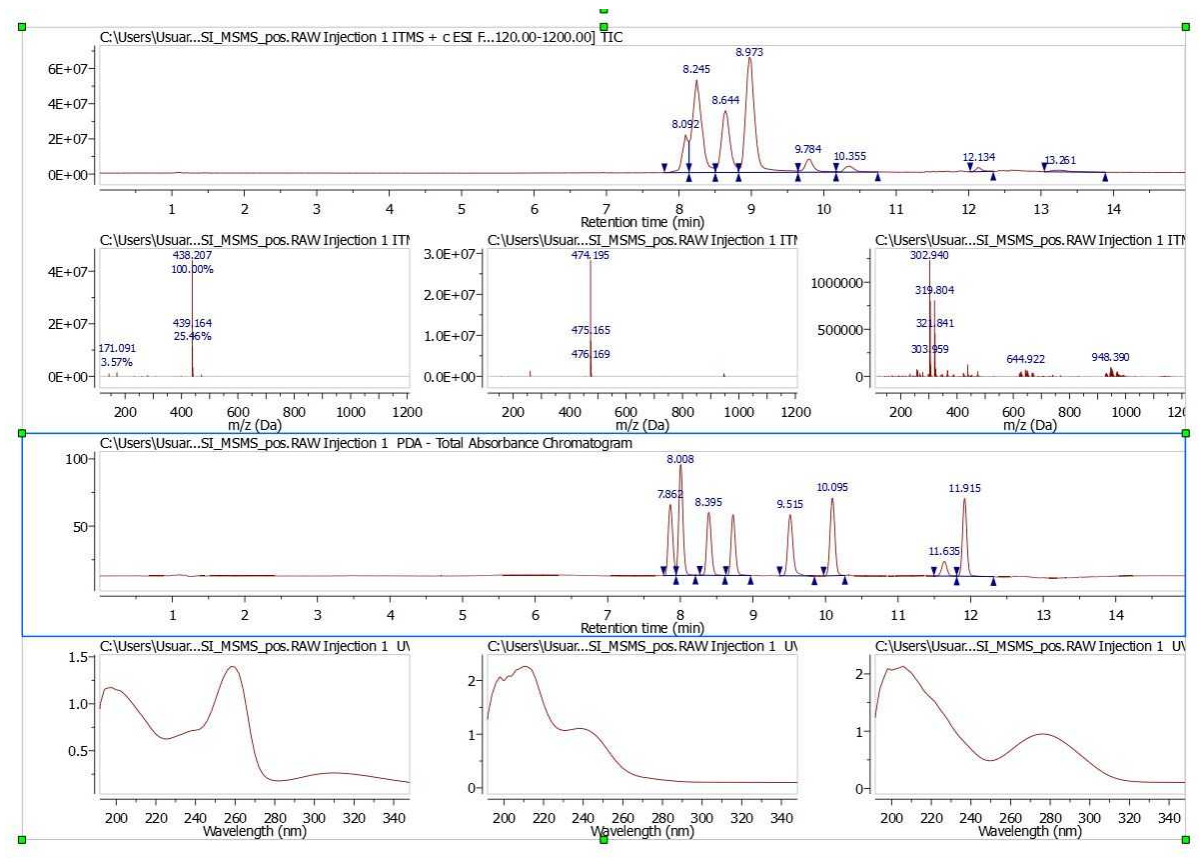

It will be possible to load/save and select the plot layout as default by using the applicable options in the 'Properties' dialog box.

Peaks Properties

You can see in the picture below the 'Peaks properties' of the TIC. From here, you can 'show the wedges' and the 'baseline' (and select the threshold) or add a second line in the peak label, with information about the Intensity, the Height from the baseline, the Area, or the Purity (which will show the integral of each peak as the percentage of all integrated peaks). Please bear in mind that the Area can not be used as a quantitative value.

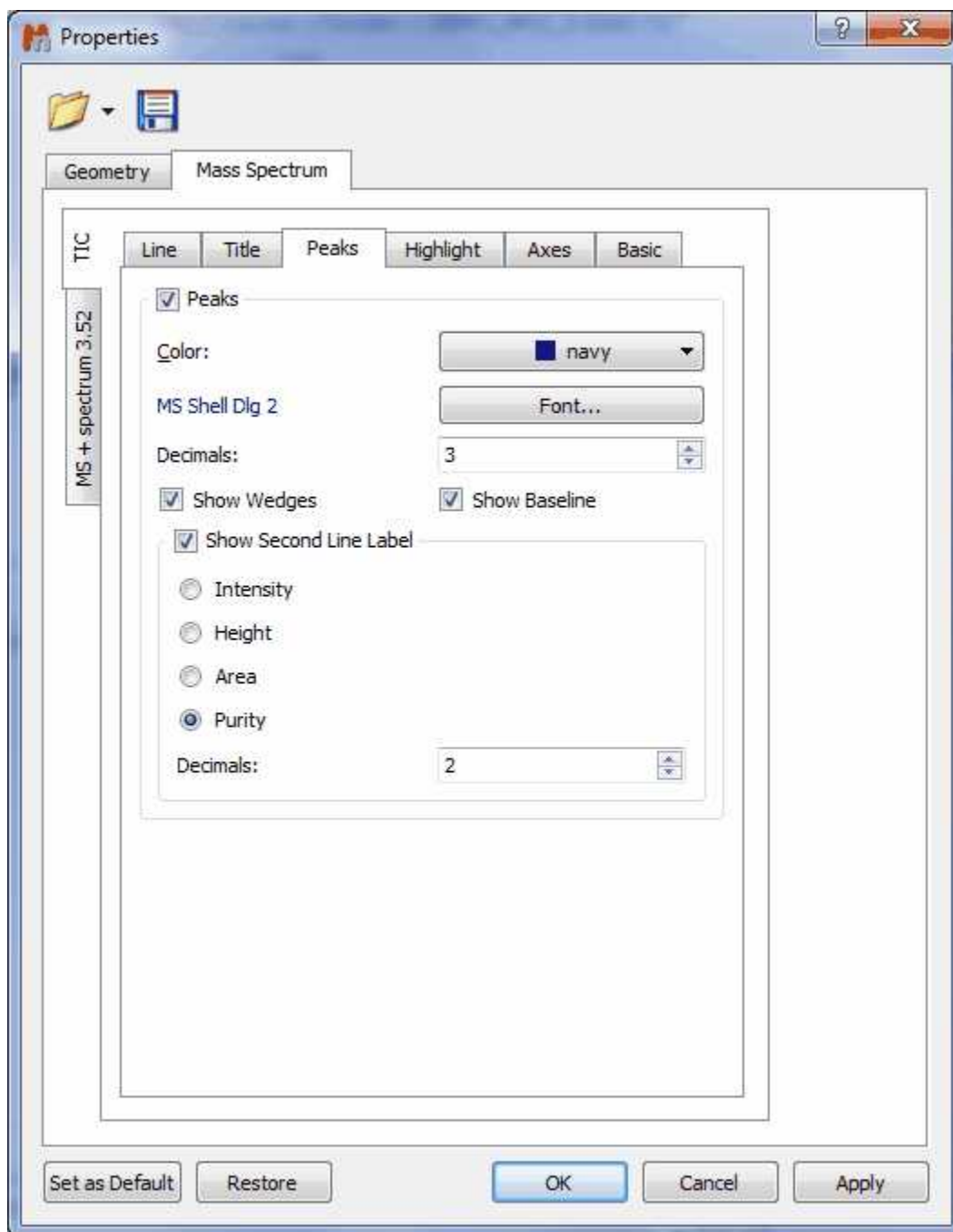

Here you can see an example of a TIC with the Purity values in the second line:

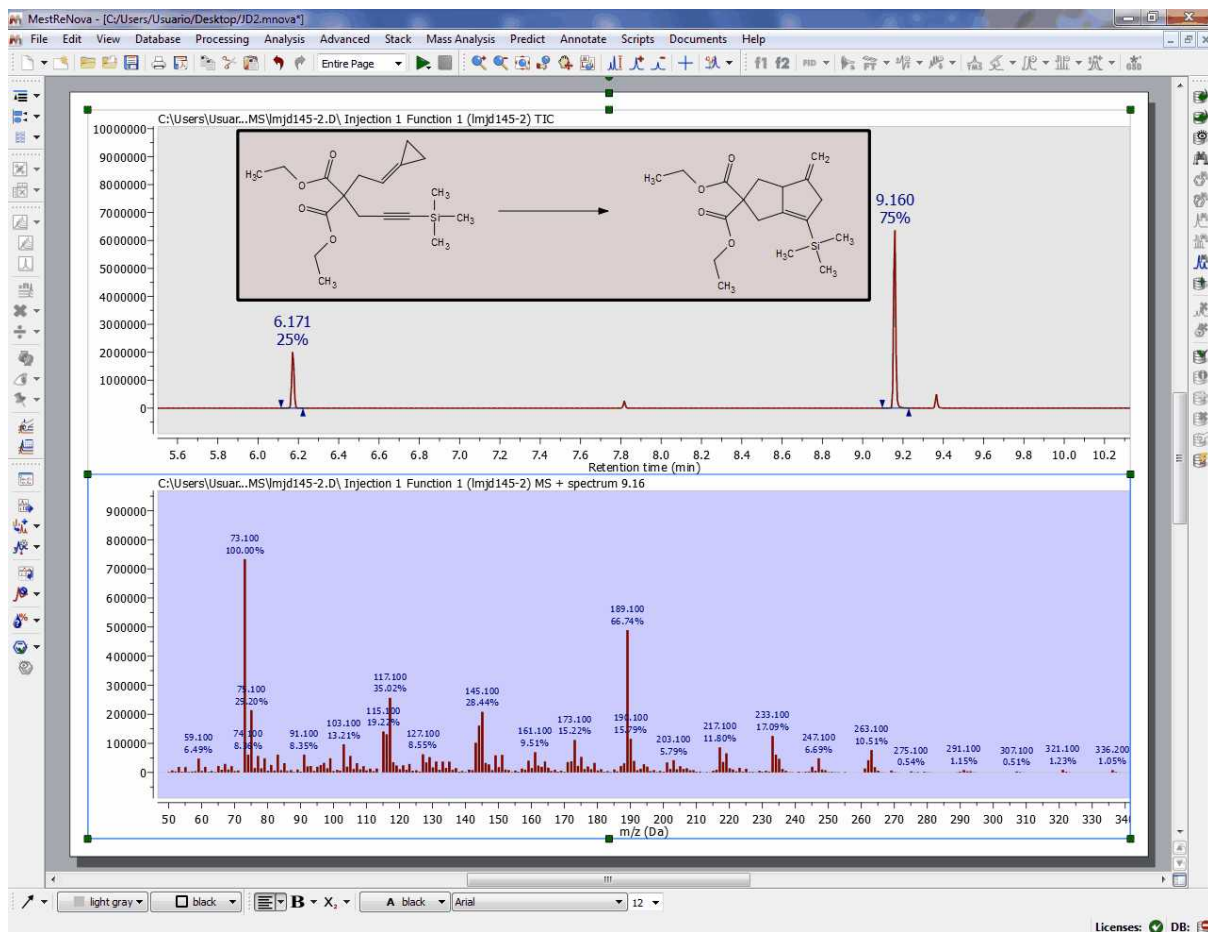

You can see below the 'Peaks Properties' dialog box of the MS spectrum. In this window, you can change the Color, Font and Number of Decimals of the Peak label and you can also show/hide the 'Second Line Label' (which can contain information about the 'Intensity' or the 'Relative Abundance').

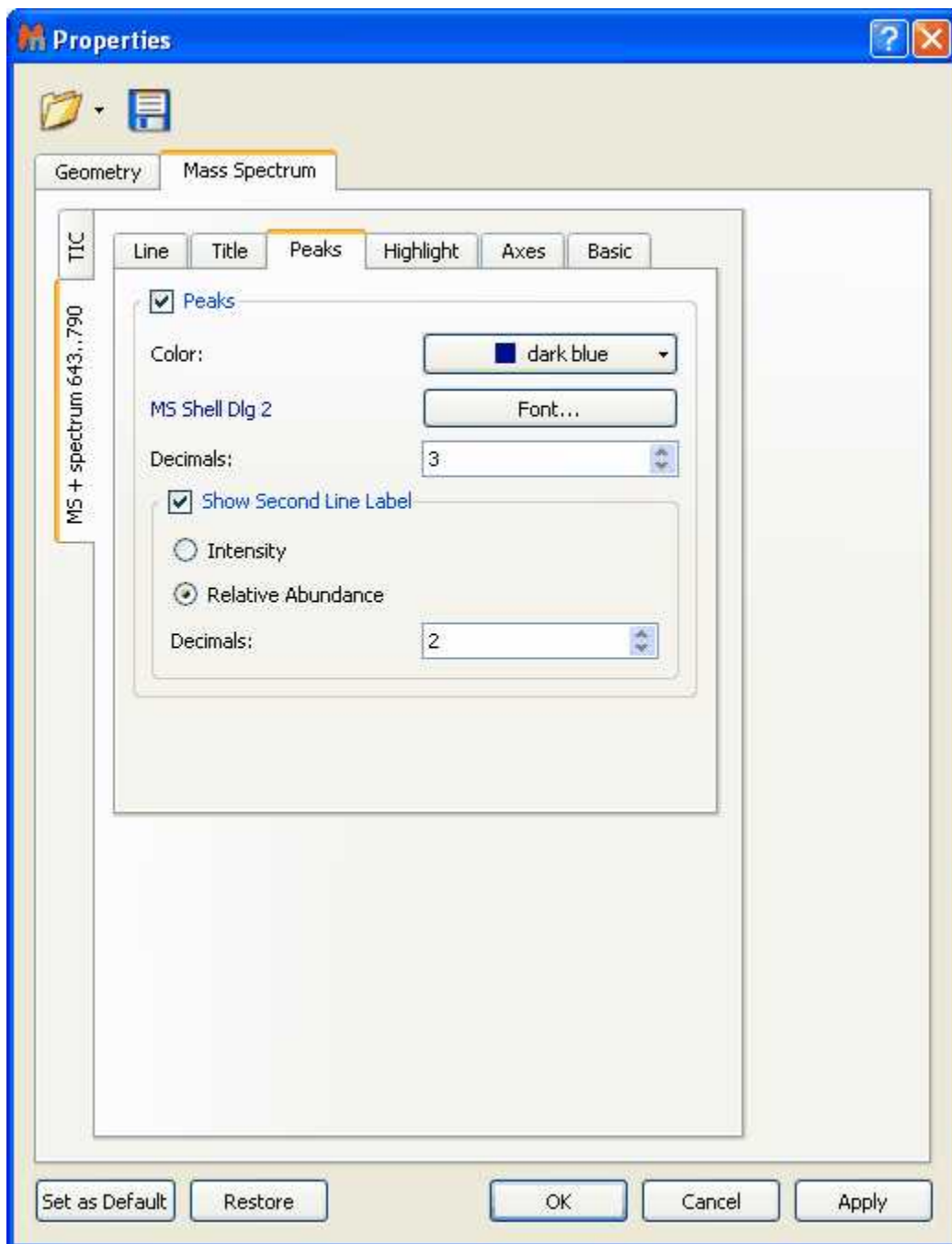

Selecting Title in the tabbed menu, will display the below window:

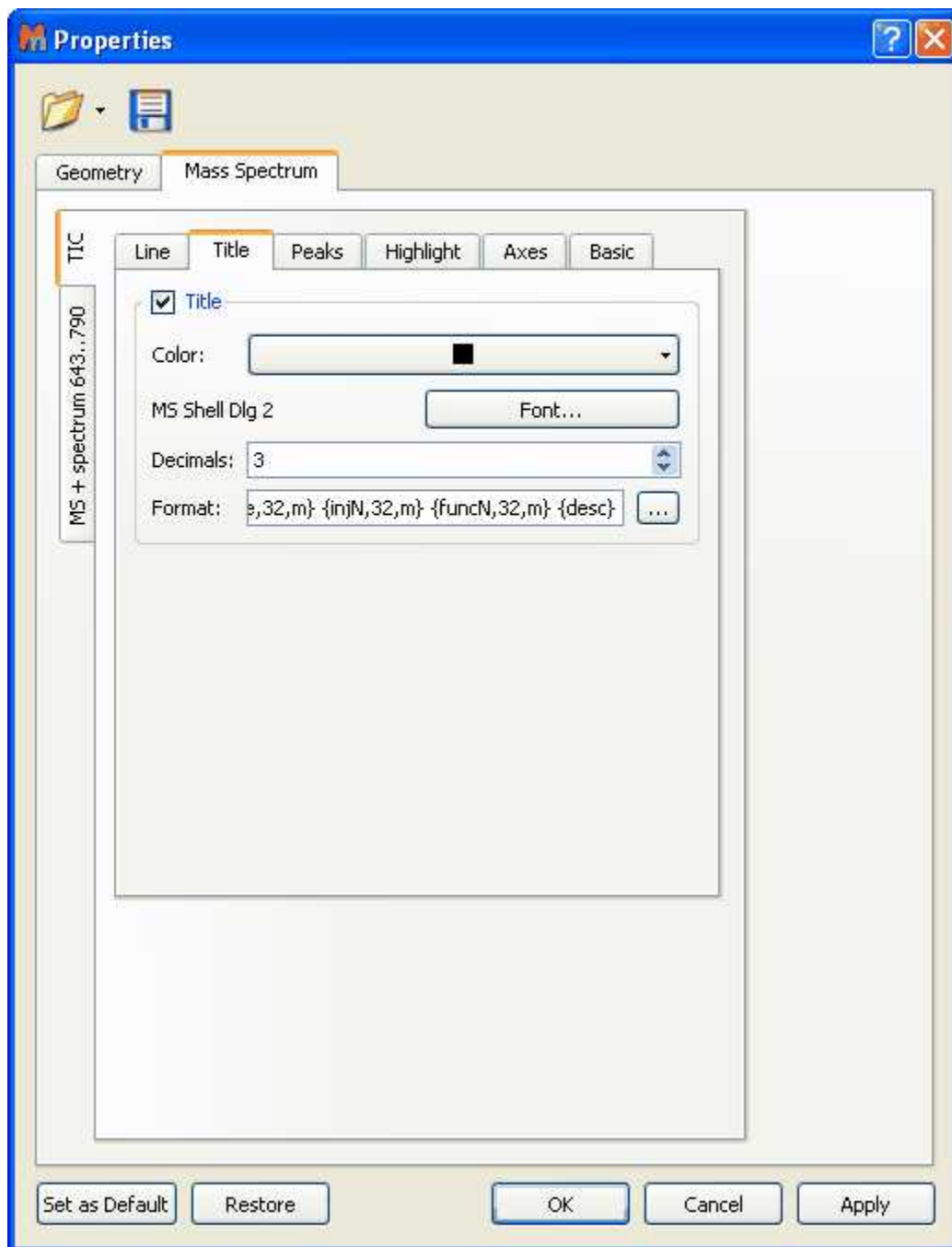

Clicking on this icon  will allow you to customize the format of the title; for example to display the 'RT' or 'Scan ranges' or to select the number of characters (Max Length; 32 by default) or the position (n: none, l: left, r: right, m: middle):

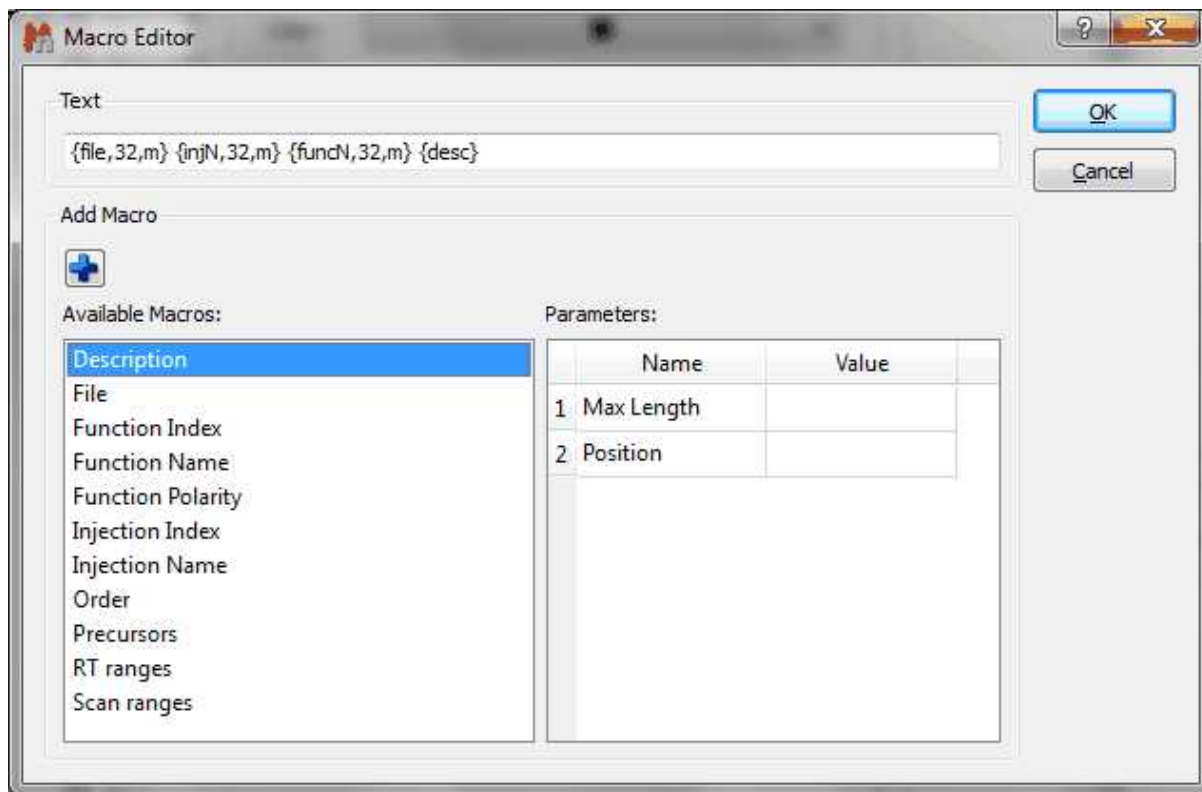

Here you can see an example of a TIC and MS after having changed some properties:

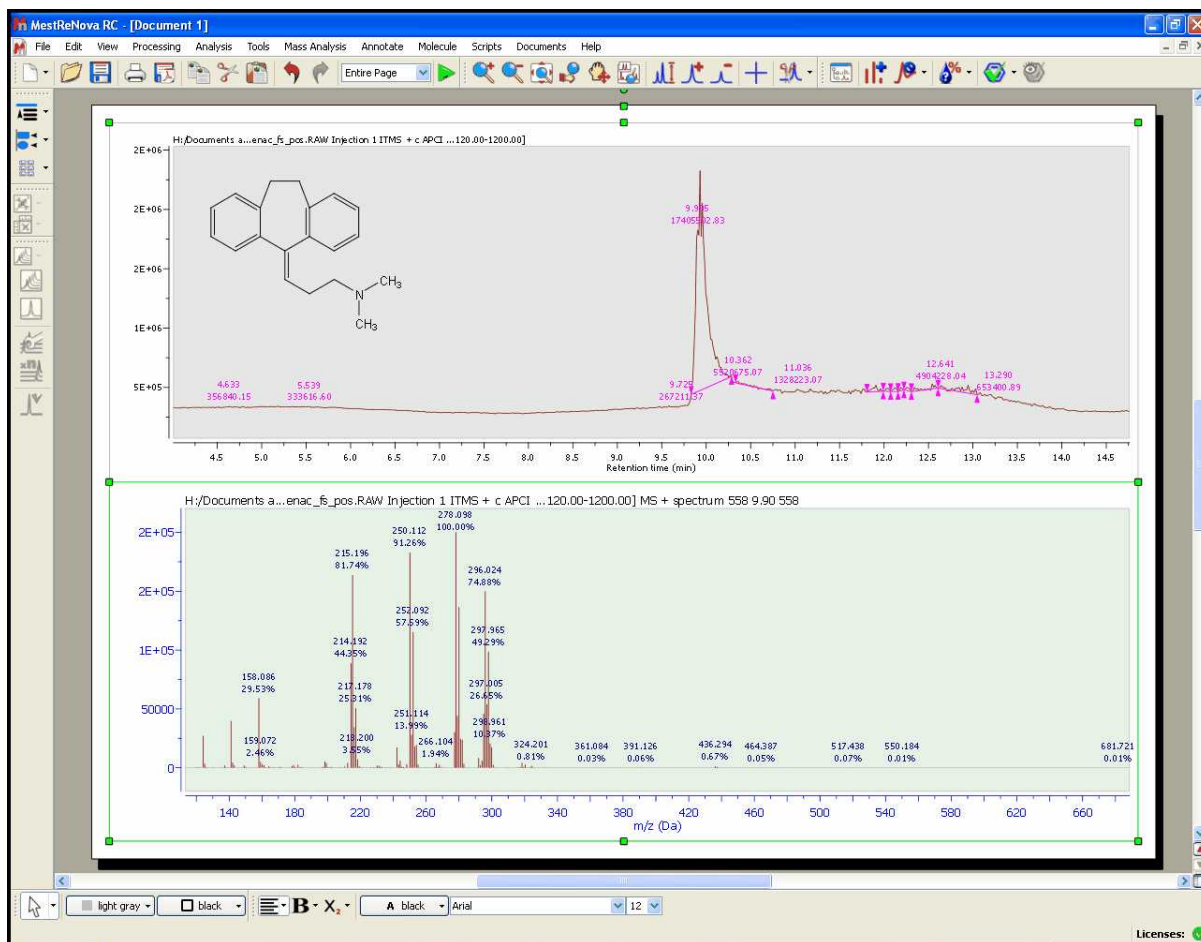

You can read more about general Mnova properties [here](#).

14.2.6 Preferences

Follow the menu Edit/Preferences/Mass to change your MS preferences:

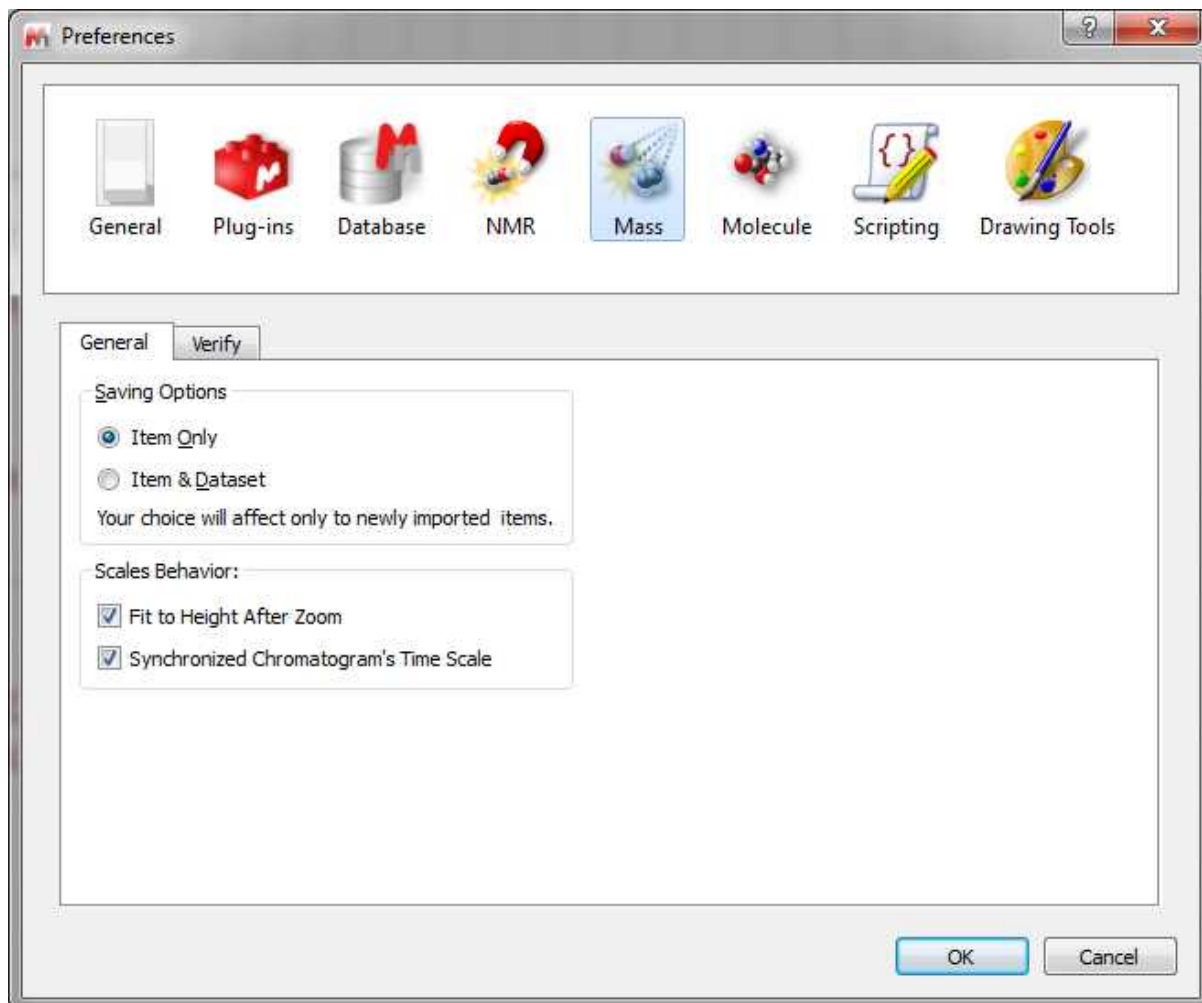

The user will be allowed to select the saving options (item only or item+dataset).

You will find also an option to fit to height after zoom (selected by default). When this option is checked, a fit to height is applied after making a horizontal zoom in a mass spectrum or a chromatogram. In case of the other zoom modes (vertical or in both dimensions), a fit to height is never applied.

When the option 'Synchronized chromatogram's Time Scale' is selected, it will be possible to zoom, pan and cut to all showing chromatograms.

Part



15 Mnova Database

This plugin is not included in Mnova Suite. If you want to try it, please email us to support@mestrelab.com

This new plugin of Mnova was born as a new concept to the shared storage for molecules, Mnova objects (texts, drawings, images, etc...), NMR and MS analysis data.

Please bear in mind that you will also need a server to store your databases. You will find [here](#) the instructions to set up that server.

15.1 Create a Database

If you do not have any previously database, you will need to create one. To do it, just follow the menu 'Database/Create Database':

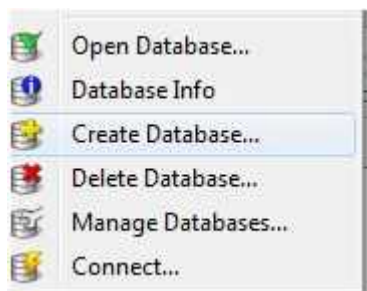

For further information about it, please go to this [chapter](#).

15.2 Connecting to the Server

Firstly, you will need to connect with the database server by following the menu 'Database/Connect' (or by clicking on the applicable icon of the toolbar ) and entering the corresponding password:

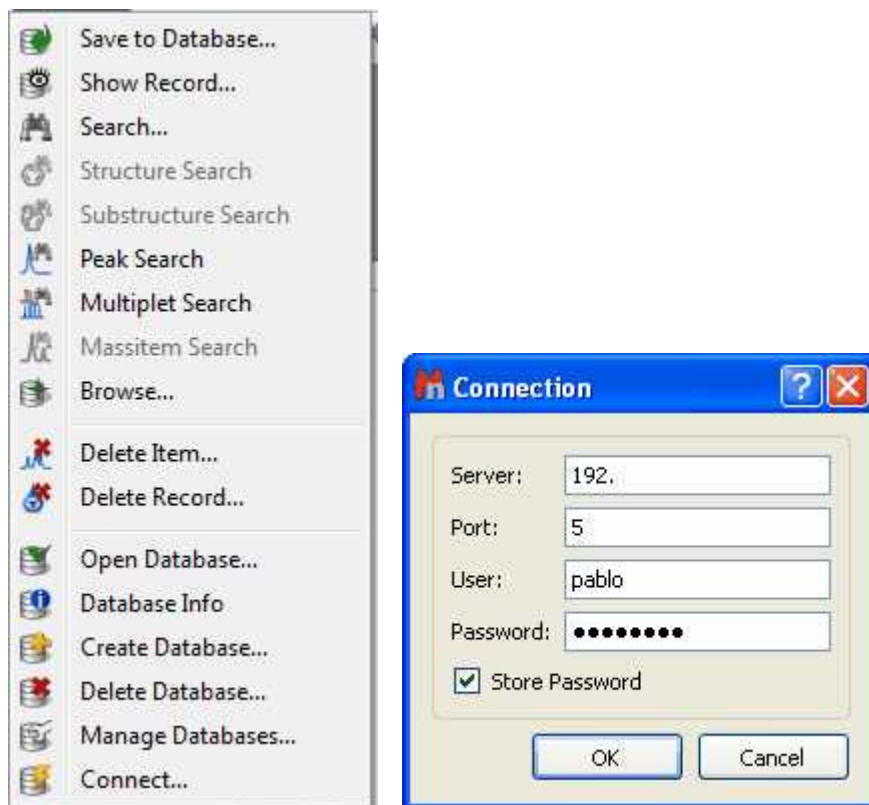

If you do not have any Database created, you will need to create one. In that case, please go to the applicable [chapter](#).

15.3 Saving items to Database

You will find the quinine datasets in the installation folder of Mnova (under the examples/datasets folder)

It will be really easy to add objects (spectra, molecules, etc...) to a database; just open your Mnova document (containing for example a 1H-NMR spectrum, a molecule and some objects) and follow the menu 'Database/Save to Database' (or click on the applicable icon of the toolbar, highlighted in red in the picture below)

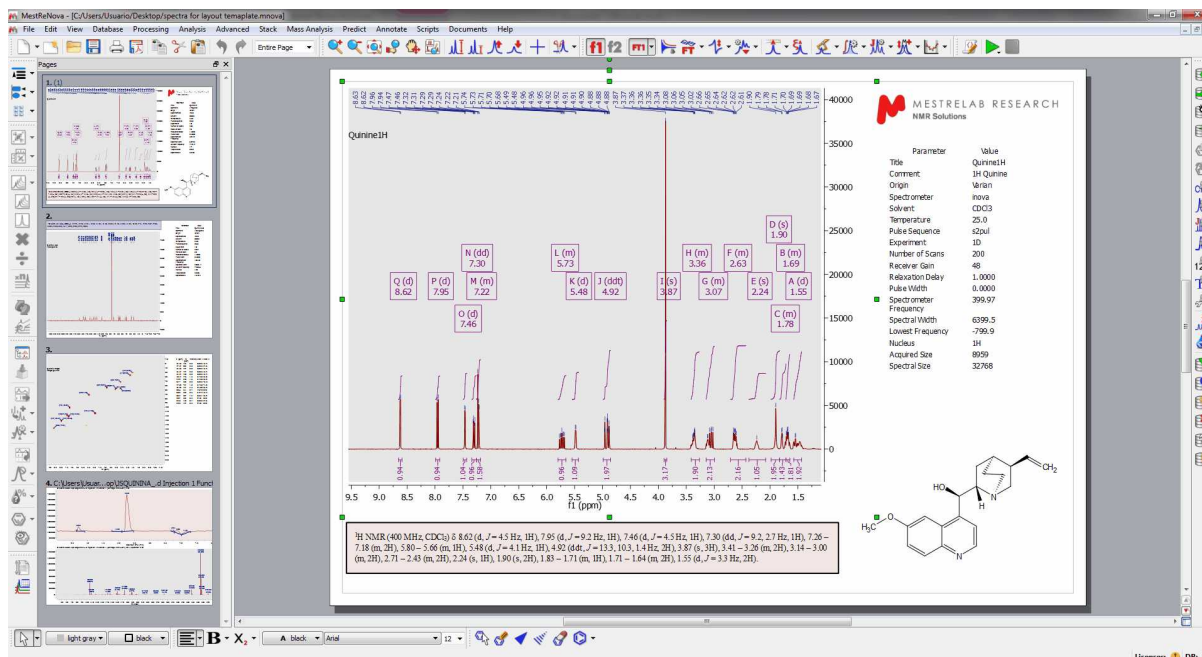

You can also 'Save to Database' by right clicking on the spectrum to display the spectrum context menu.

After having selected 'Save to Database', you will get a new dialog box where you will see how the spectrum and the molecule are selected by default to be added to the database. If you want to add also the other objects, you will need to check the corresponding boxes or click on the 'All' button. (Please bear in mind that it will not be possible to save more than one molecule for each spectrum):

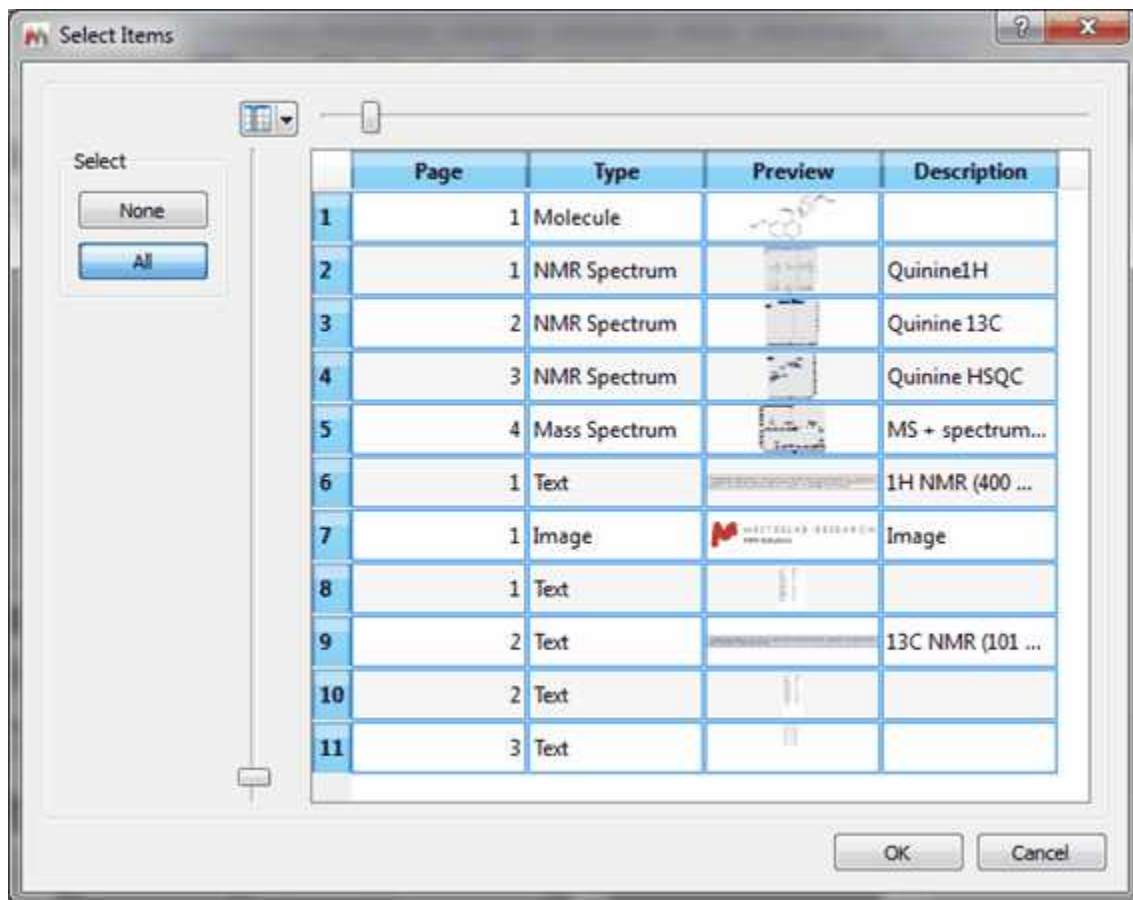

Once you have done the selection just click on OK to save to the database. During this procedure, Mnova will check the database to find similar spectra or molecules.

If your dataset is new in the database, you will only get a 'Save Complete' message and your dataset will be added to the database:

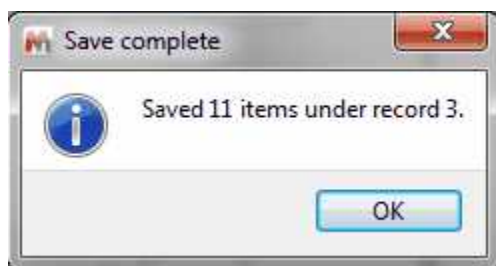

If it finds a match during the saving procedure, it will ask you to add the new items to the compound (to avoid duplications). for example imagine that you want to add the 13C NMR spectrum of the 'compound 1' (quinine in this case) to your database.

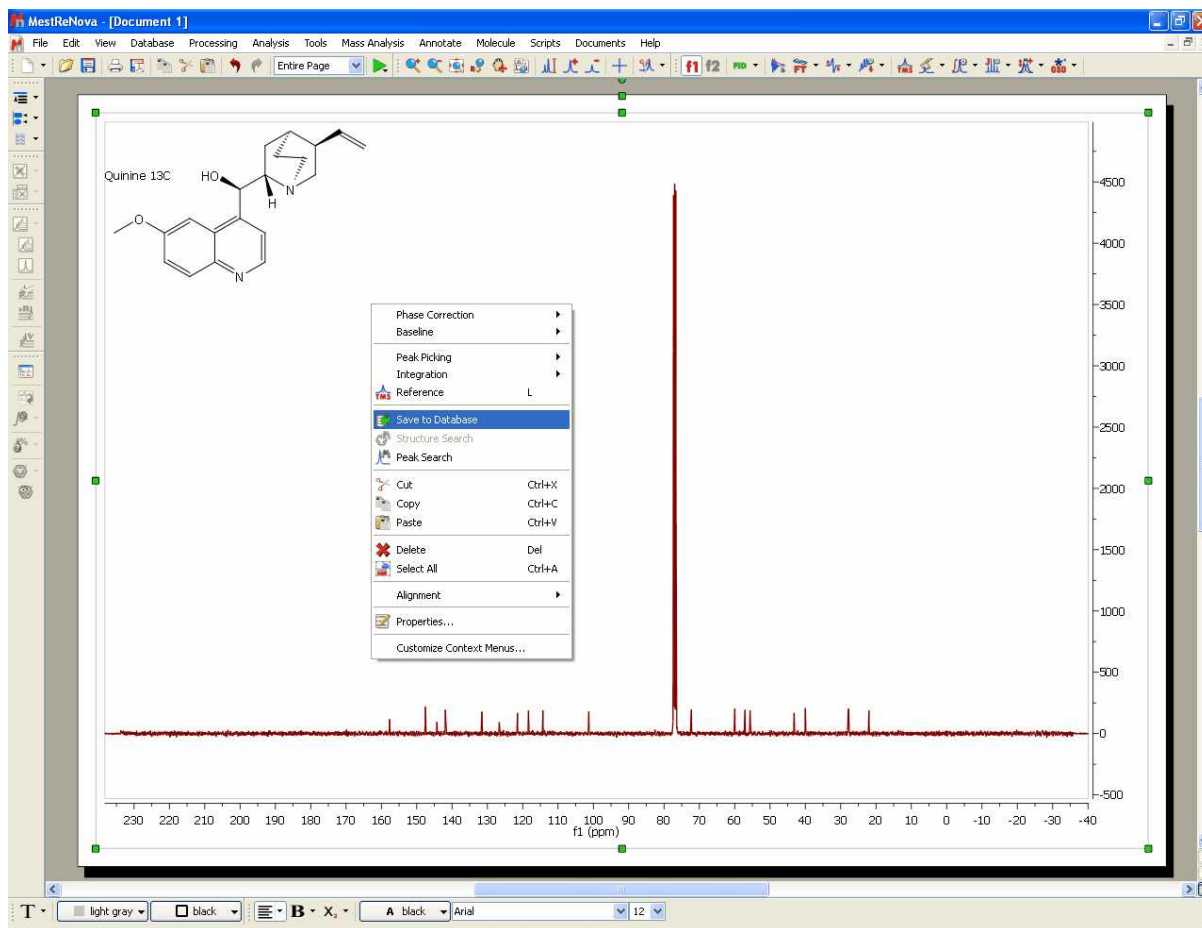

In that case, Mnova will find a compound with the same molecule structure, so you will only need to check the OK button (highlighted in red in the picture below) to add the new spectrum to the compound 1 of the database:

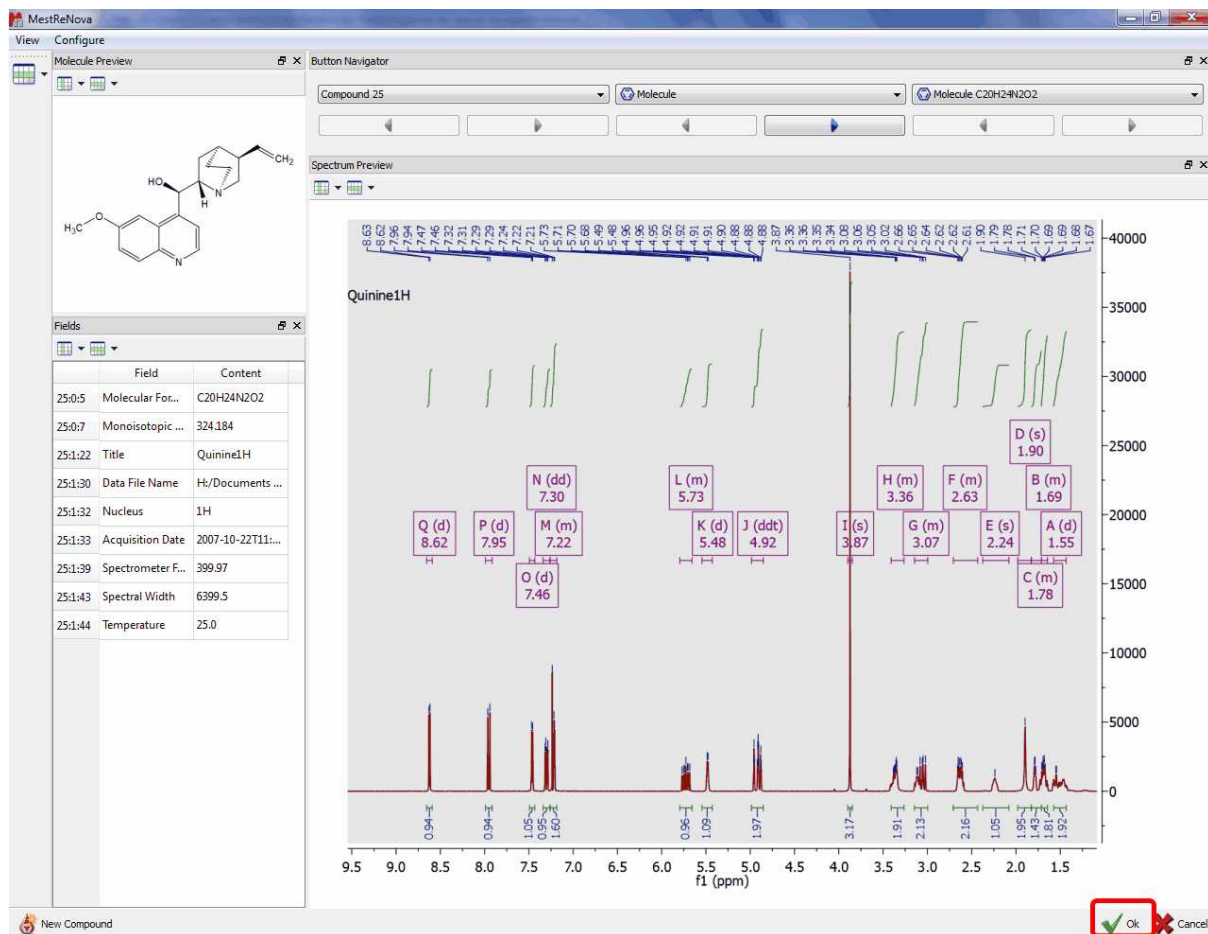

After having clicked on the OK button, a new dialog box will be displayed to ask you whether to add or replace (when existing items have been found matching those being saved):

	Current	Replace With
Atoms	23.0	23
Bonds	26.0	26
MoleculeId	{8aebeaa5-9f5e...}	{8aebeaa5-9f5e...}
CHEMICAL STRUCTURE	88.5254 -64.7... 1 2 1 0 0	88.5254 -64.7... 1 2 1 0 0 0 0
Molecular Formula	C18H24O2	C18H24O2
Average Mass	272.382	272.3819599999...
Monoisotopic Mass	272.178	272.1776299999...
Uuid	{7fe8fb4b-d763...}	{7fe8fb4b-d763...}
Type	Molecule	Molecule
Text	-	-
Preview		
User	Pablo	Pablo
Host	MESTREPABLO	MESTREPABLO
Document	C:\Users\Usuari...	C:\Users\Usuari...
Created	vie 16. abr 08:19...	vie 16. abr 08:22...
Modified	vie 16. abr 08:19...	vie 16. abr 08:22...
MNOVA Version	6354	6354

If for some reasons, you do not want to add the ^{13}C spectrum to the compound 1, just click on the 'New Compound' button (left-bottom side of the screen).

Of course, it will be also possible to add 2D NMR or MS datasets to the database. In the case of 2D datasets, if the file size is too big, we recommend to use the ['Compression'](#) feature (under the Processing menu) before uploading the experiments to the database.

If your document contains more than one compound and several molecules are selected for saving, a warning message will be displayed:

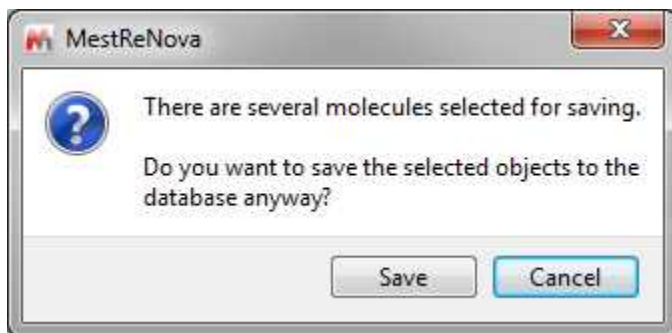

When the user chooses to continue, several records (one for each selected molecule) are created in db and each of the records will contain all of the selected spectra.

15.4 Displaying database contents

In this chapter you will find information about how to display the content of your Database.

15.4.1 Operations

Once you have created the database, you will be able to search for any record just by using the 'Show Record' or the 'Browser'.

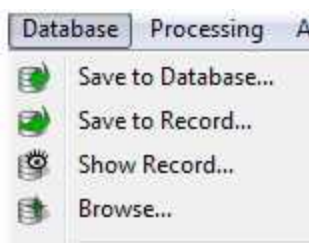

Show Record

This feature will allow you to find compounds by using their ID. The first record added to the database will have the ID number 1; the second record will have the ID number 2 and so on:



Browser

The Browser will allow you to show a range of records:



15.4.2 Searching in the Database

You can use the applicable commands to search 'structures', 'substructures', 'formulas', 'peaks', 'multiplets', 'Massitems', 'numbers', 'texts', etc':

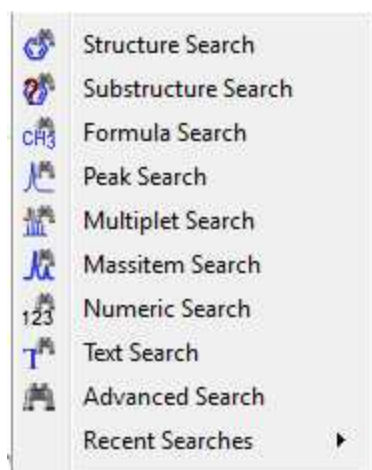

Structure Search

It will be possible to search for any molecular structure in the database. To do it, just right click on the molecular structure (or highlight the molecule and follow the menu 'Database/Structure Search') and select 'Structure Search' which will display the Query Editor. Click on OK to run the search.

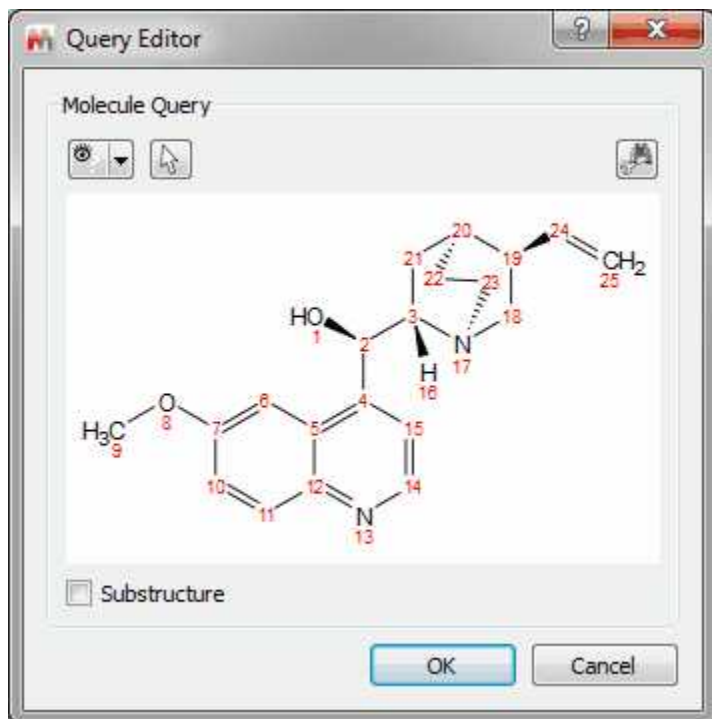

From here, you will be able to run also Substructure searches just by checking the applicable box.

Clicking on the 'Convert to advance query' button  will allow you to convert it to an advanced search so that you can add new queries and combine them.

You can also see the mol file as plain text, by selecting the applicable option in the 'Select Display Mode' scroll down menu:

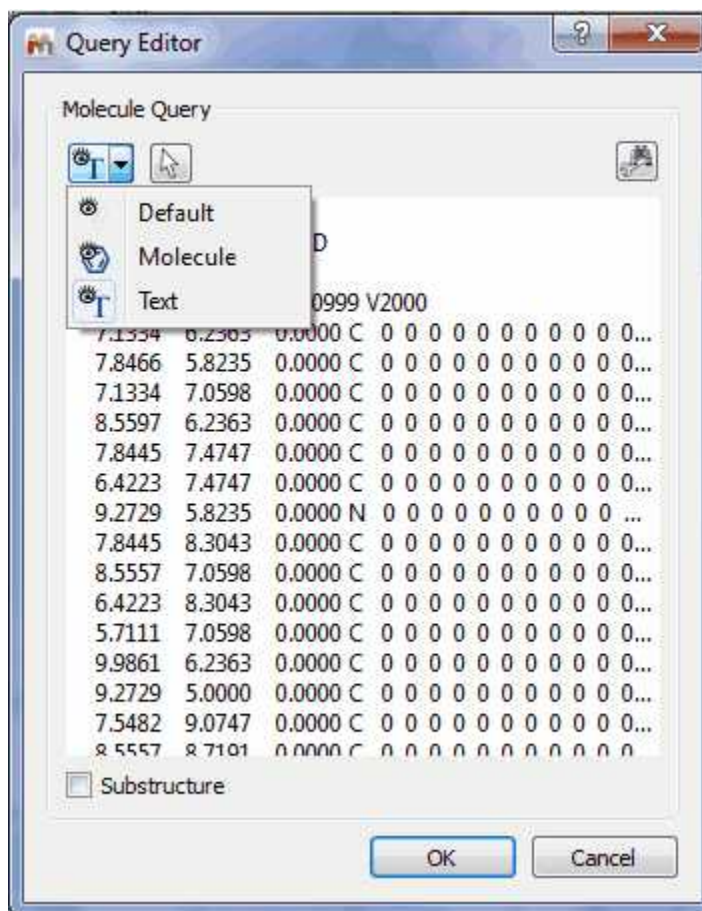

This button  will allow you to select which molecule you want to search in the case that you have several molecules in the same document.

After having clicked on OK, Mnova will search for the molecule in the database.

- If the molecule is not in the database you will obtain this message:



- If the molecule structure is stored in your database, Mnova will show you the information which appears in the database about this compound. For example, imagine that you load the molecule structure of the quinine and you select 'Structure Search'. In that case, you will obtain a window like this one (with a Match Score of 1000 which is the maximum value):

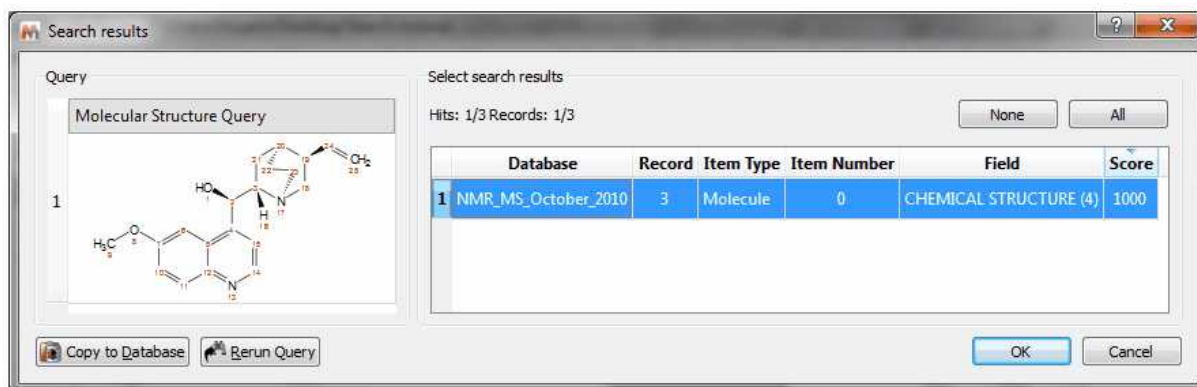

Note: Clicking on the Copy to database button, will allow you to copy the result to another database. Clicking on the 'Rerun Query' button will allow you to refine your search.

Click on OK to get a similar window like the one below:

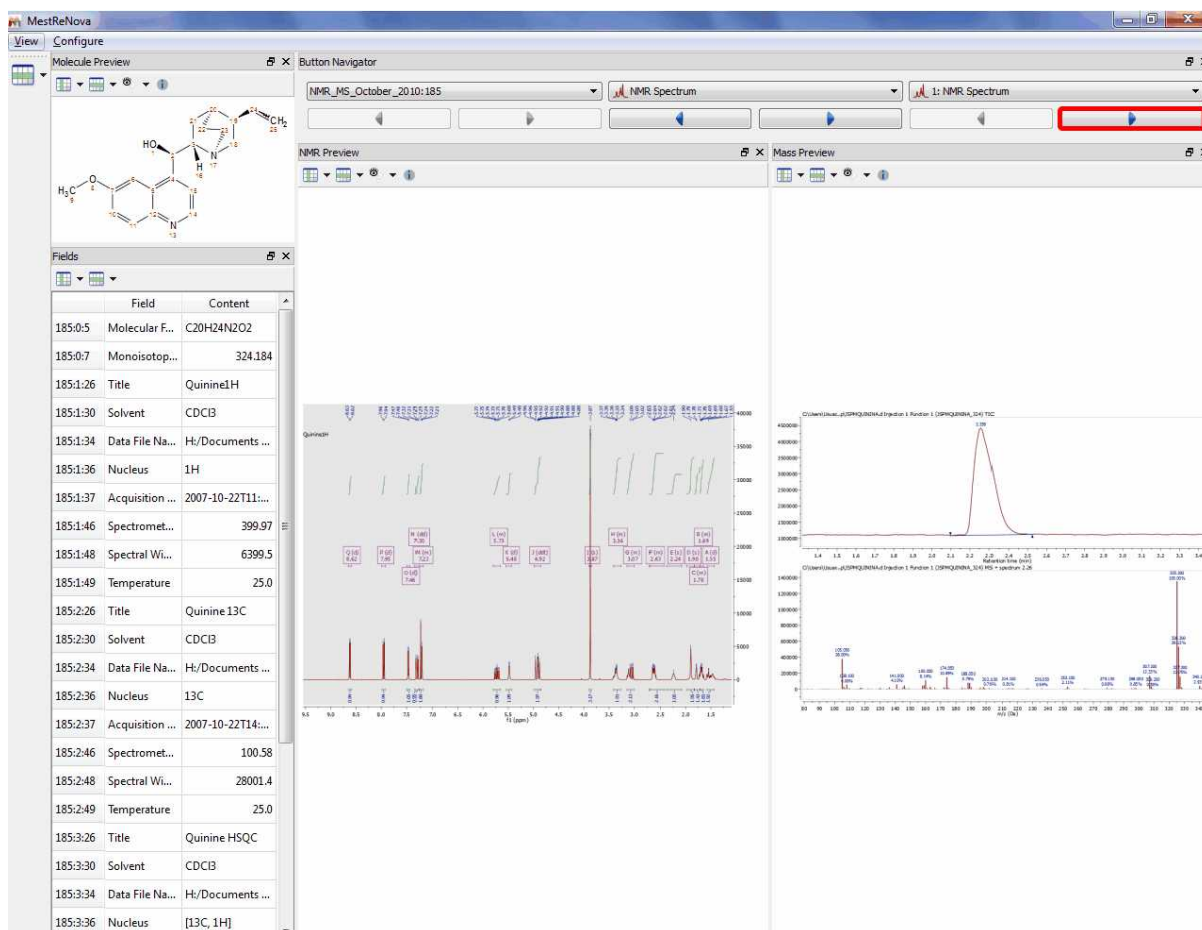

Please bear in mind that you can also see the any other spectrum (such as a 13C NMR) if we have previously added to the database, just by clicking on the 'blue arrow' (highlighted in red in the picture above):

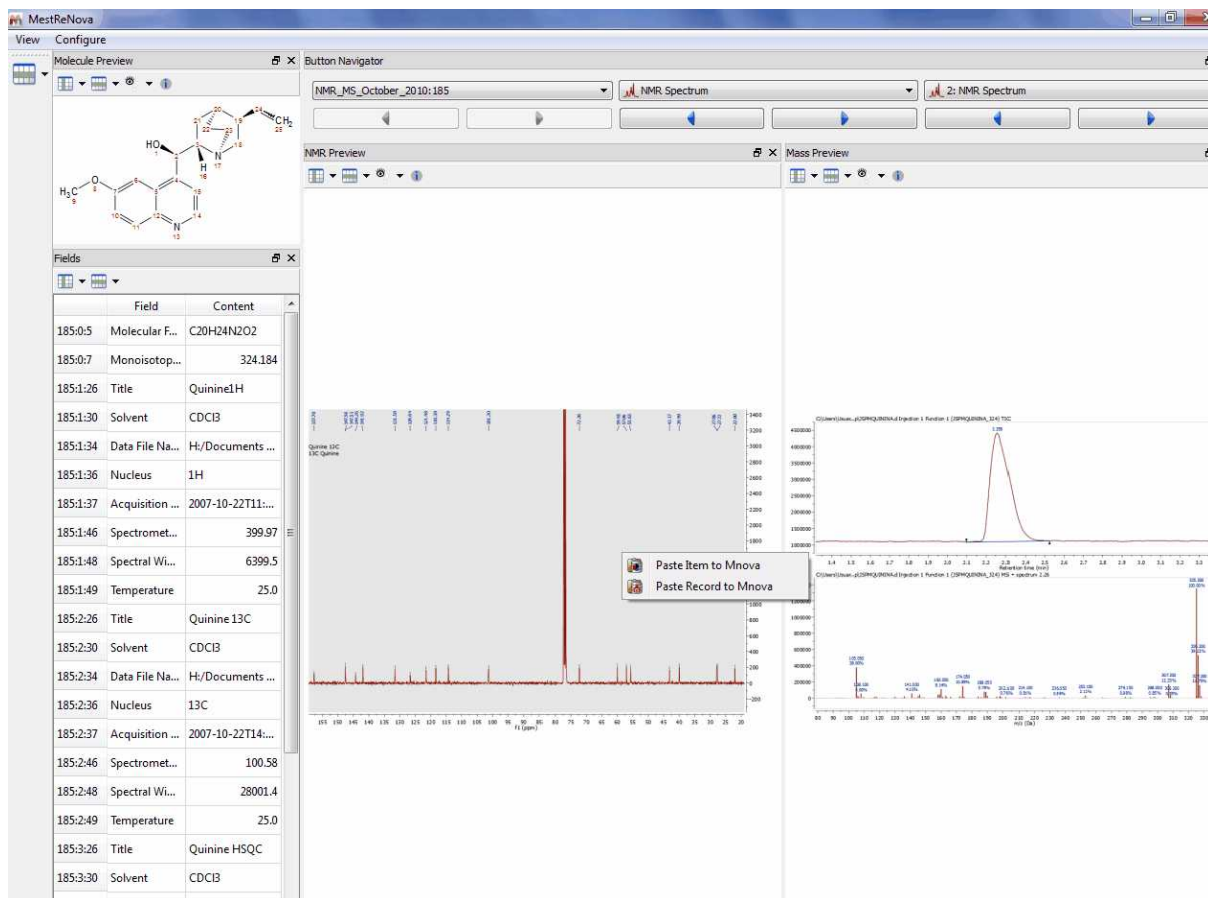

You can also copy the spectra or the molecules to a Mnova document just by double clicking on it (or right clicking and selecting 'Paste Record or Item to Mnova').

You can also use generic atoms like R (any chain, except H, D and T), Z (any chain; including H, D and T), A (any atom, except H, D, T), X (any halogen), Ht (any heteroatom) in the molecular structures. For example, to search for alcohols or amines, draw the corresponding group (and anything else you want the results to contain), add Zs (Z-NH₂, Z-OH), and do a structure search.

Here you can see an example to find compounds containing C=C double bonds:

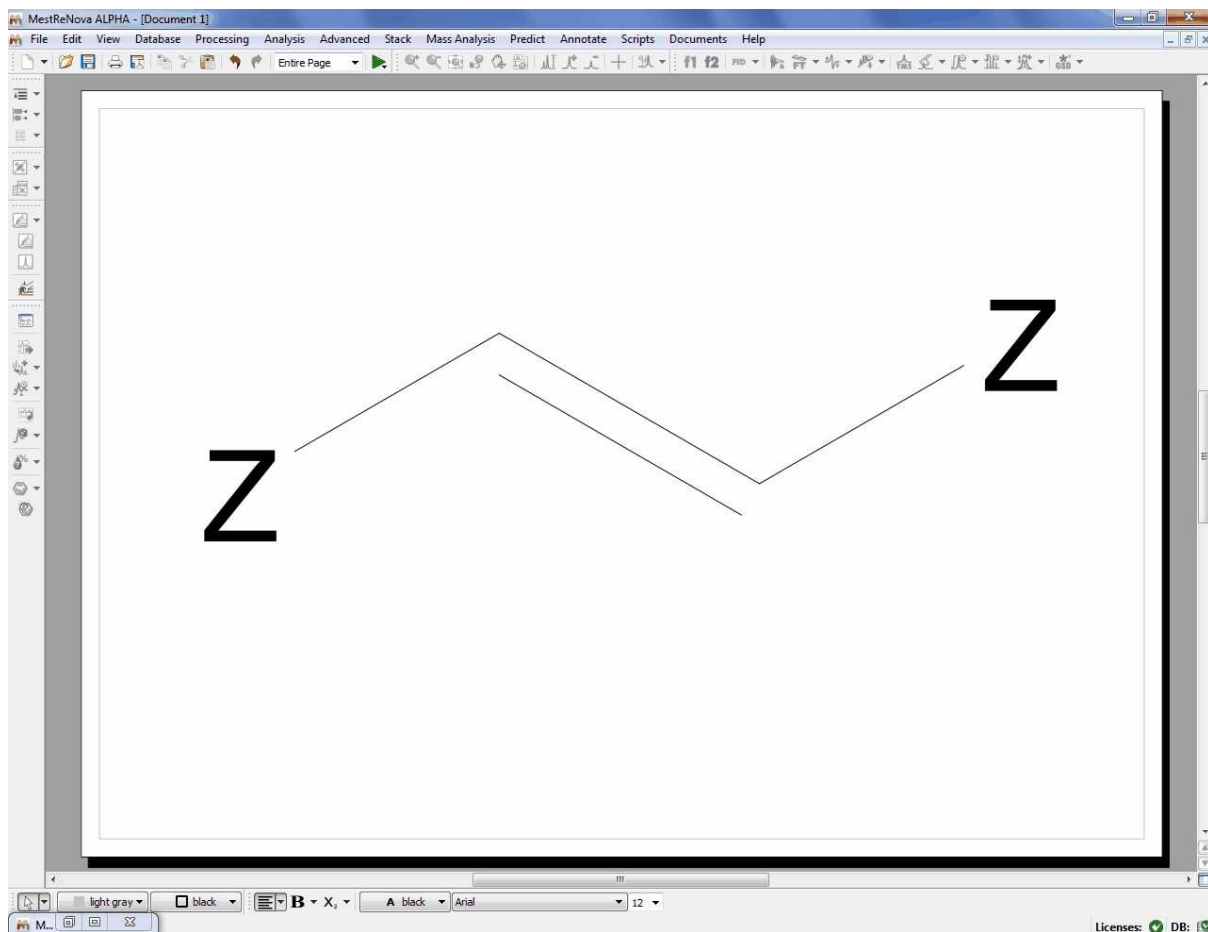

If you want for example to find compounds with at least four C=C double bonds, you can draw this:

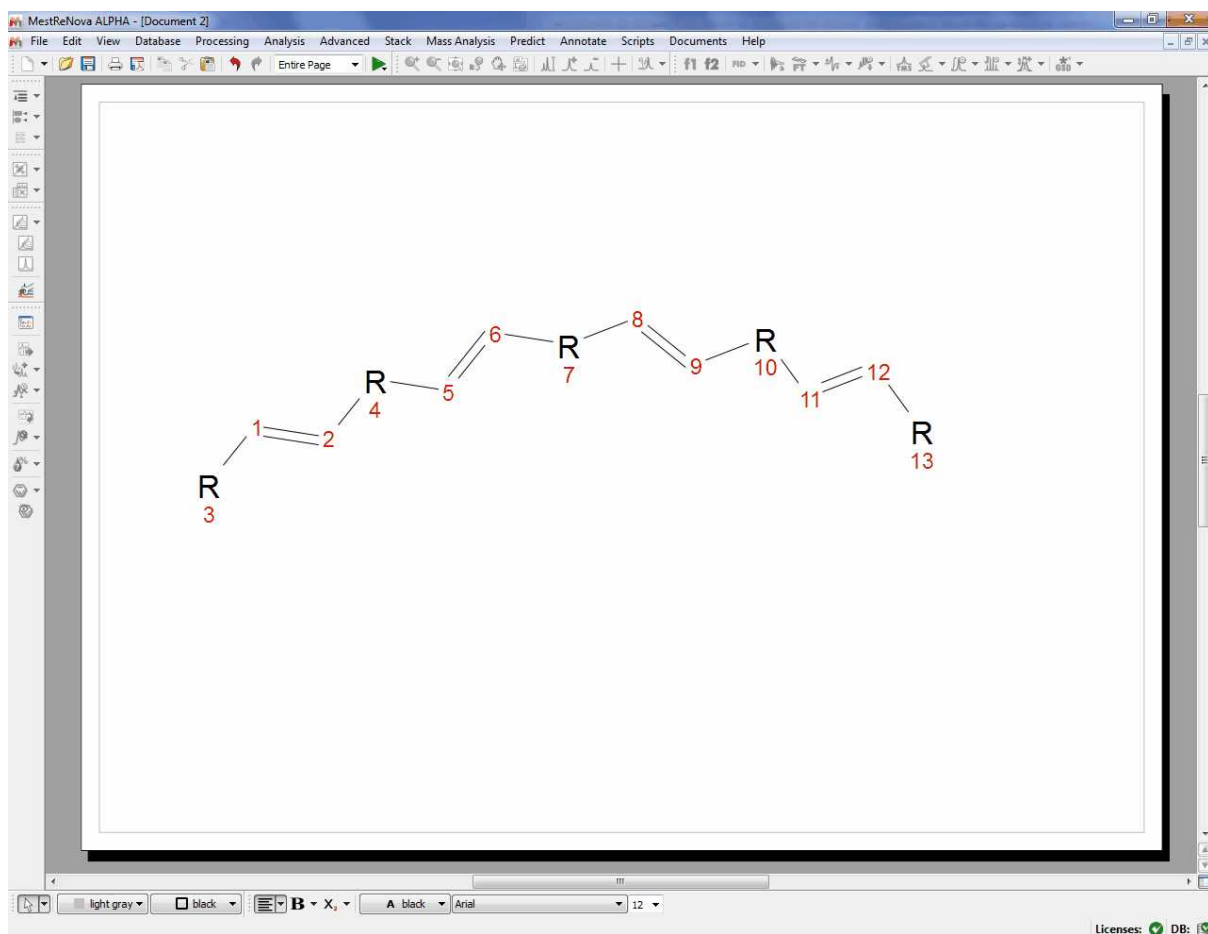

If you want to search for ketones, you can draw this molecular structure:

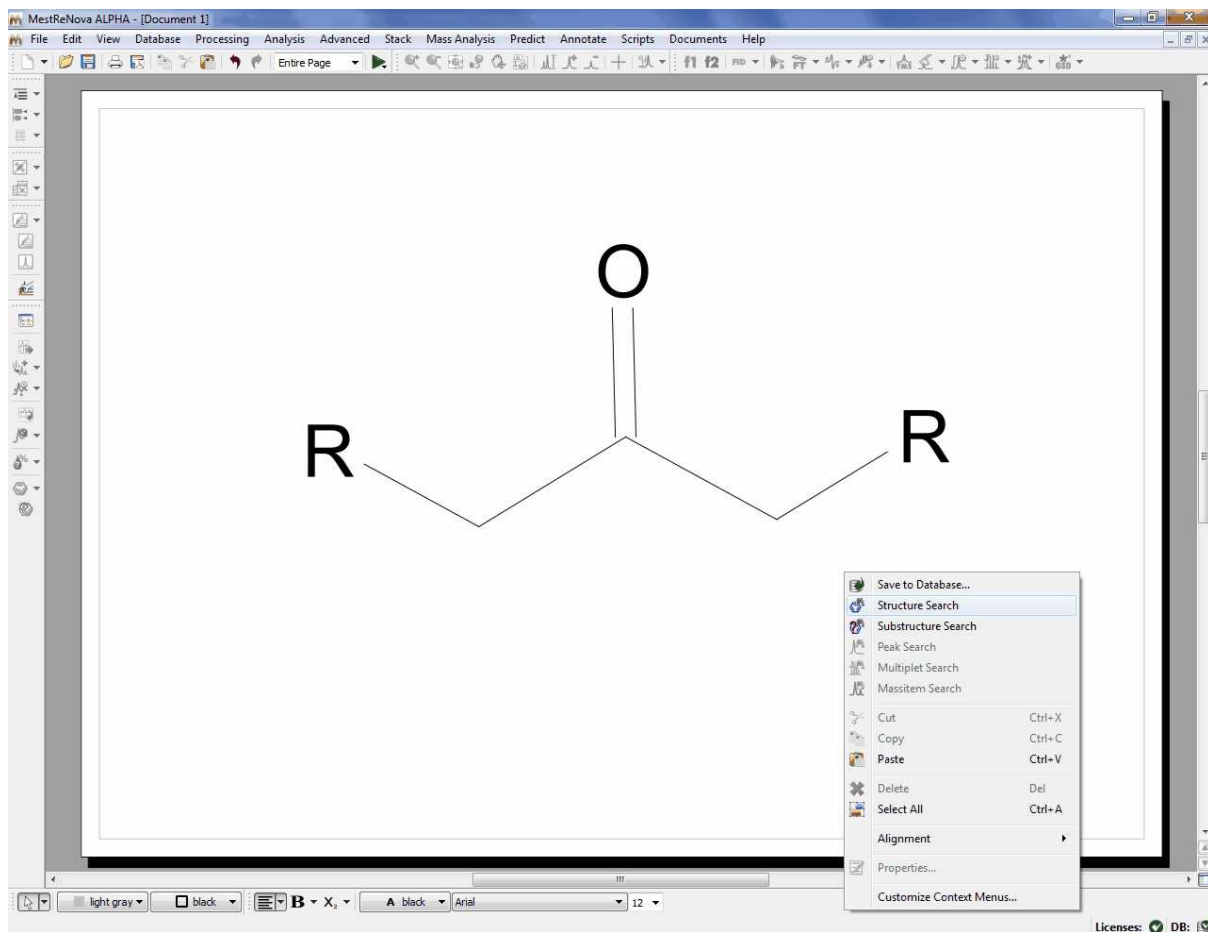

Substructure Search

The SubStructure Search feature is used to locate products by chemical structure. Simply copy a structure fragment, right click on it and select 'Substructure Search':

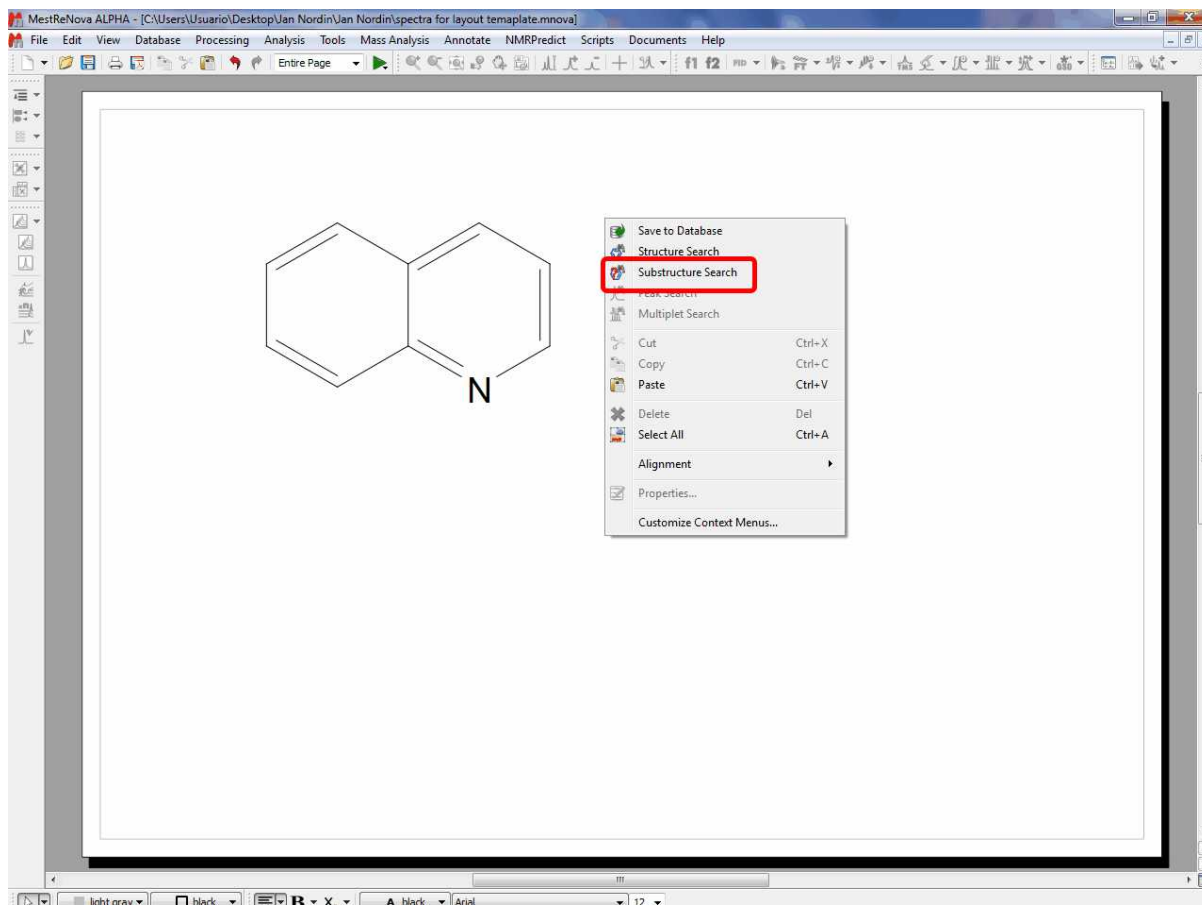

In that case we have obtained three hits (for the records 5, 10 and 25):

The 'Search results' dialog box displays the following table of results:

Select search results					
None					
All					
	Compound	Item Type	Item Number	Field	Score
1	5	Molecule	0	CHEMICAL STRUCTUR...	1000
2	10	Molecule	0	CHEMICAL STRUCTUR...	1000
3	25	Molecule	0	CHEMICAL STRUCTUR...	1000

Below the table, it indicates: Hits: 3/3, Compounds: 3/3. At the bottom of the dialog are buttons for 'Copy to Database', 'Rerun Query', 'OK', and 'Cancel'.

You can also use generic atoms like R (any chain, except H, D and T) ,Z (any chain; including H, D and T) ,A (any atom, except H, D, T) ,X (any halogen) ,Ht (any heteroatom) in the molecular structures. For example, to search for alcohols or amines, draw the corresponding group (and anything else you want the results to contain), add Zs (Z-NH₂, Z-OH), and do a substructure search.

Formula Search

This feature will allow you to search for any specific molecular formula of your database. To do that, just type the molecular formula in the 'edit box' and click on OK. You can restrict (it is not mandatory) the search by using the 'ItemType' and 'Field' options:

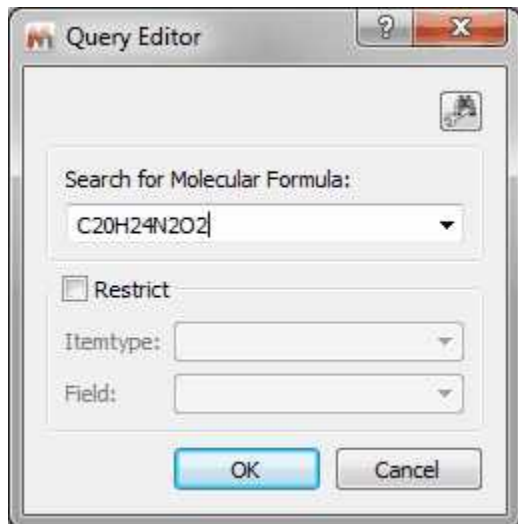

The format for a **molecular formula search** is quite flexible. It can be explained with some examples:

- If you type: C1,4 H3,8 N1,1; the program will search for molecular structures with 1 to 4 carbons, 3 to 8 H and exactly one N; other elements are allowed but not necessary. Note that spaces can be omitted.
- Elements can be in lower case, as long as there are not 2 without space, so "c1,4h3,8n1,1" would be OK, whereas "c4,7no" is not, since "no" will be interpreted as "No".
- Ranges can be omitted, so "C" is the same as "C1,1", "C3" is the same as "C3,3", "C,4" is the same as "C1,4" and "C2," is the same as "C2,8"
- The meta symbol "HT" can be used for hetero atoms, "X" for halogens, and "!" (exclamation mark) at the end of the formula to only allow specified elements. Thus, "C1,4 Ht3" searches for 1 to 4 carbons and exactly 3 hetero atoms, whereas "C3,5 H6,10!" would search for hydrocarbons with 3 to 5 C and 6 to 10 H.

Peak Search

If you have a spectrum loaded in Mnova (this is not mandatory) and you select 'Database/Peak Search' (or right click/Peak Search'), the application will look for these peaks in the database. If you have expanded any area of the spectrum, it will only look for the peaks of the expanded area (and not for the whole spectrum). Please bear in mind that if you have forgotten to apply the Peak Picking to the expanded area, Mnova will do it (by using the automatic Peak Picking).

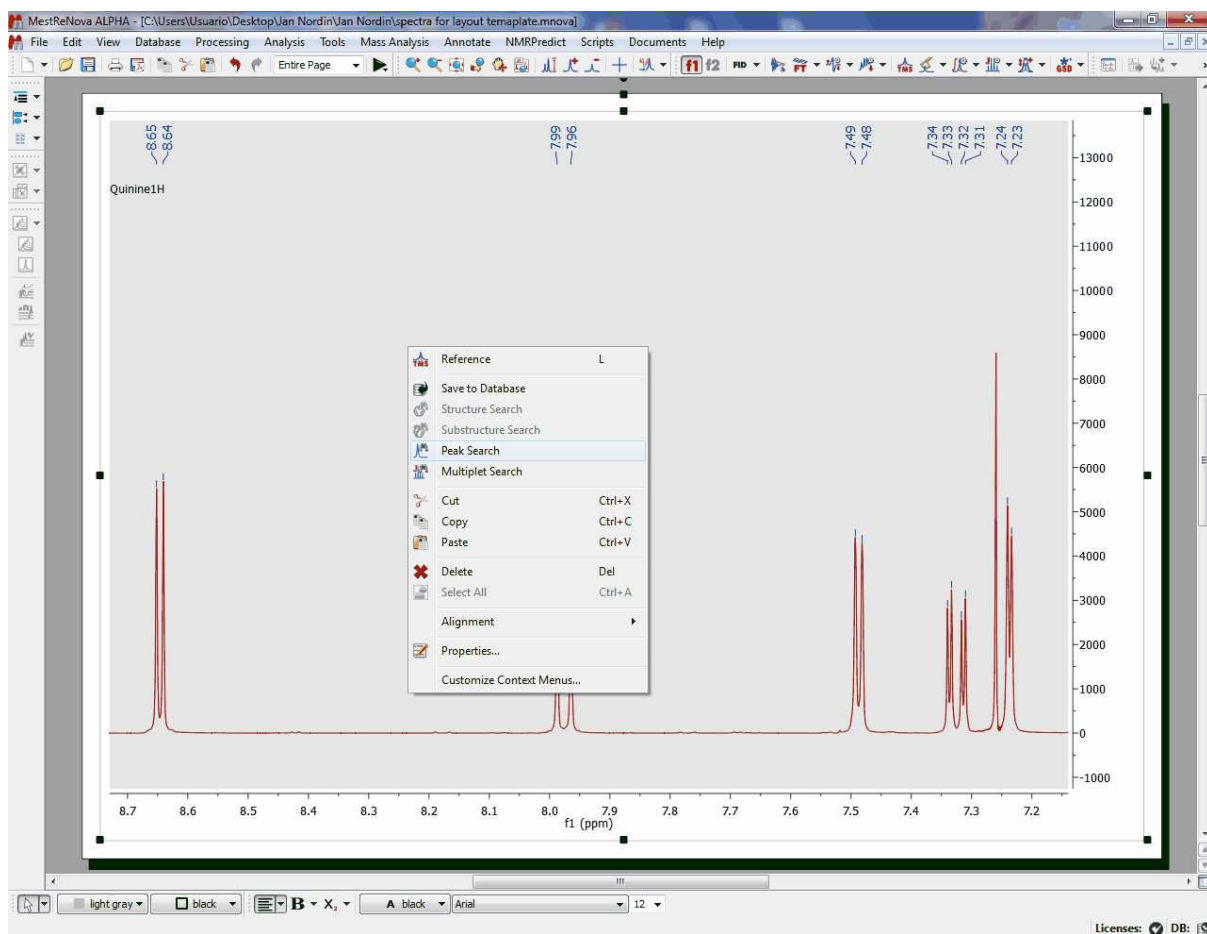

After having selected the Peak Search feature, the Query Editor dialog box will be displayed:

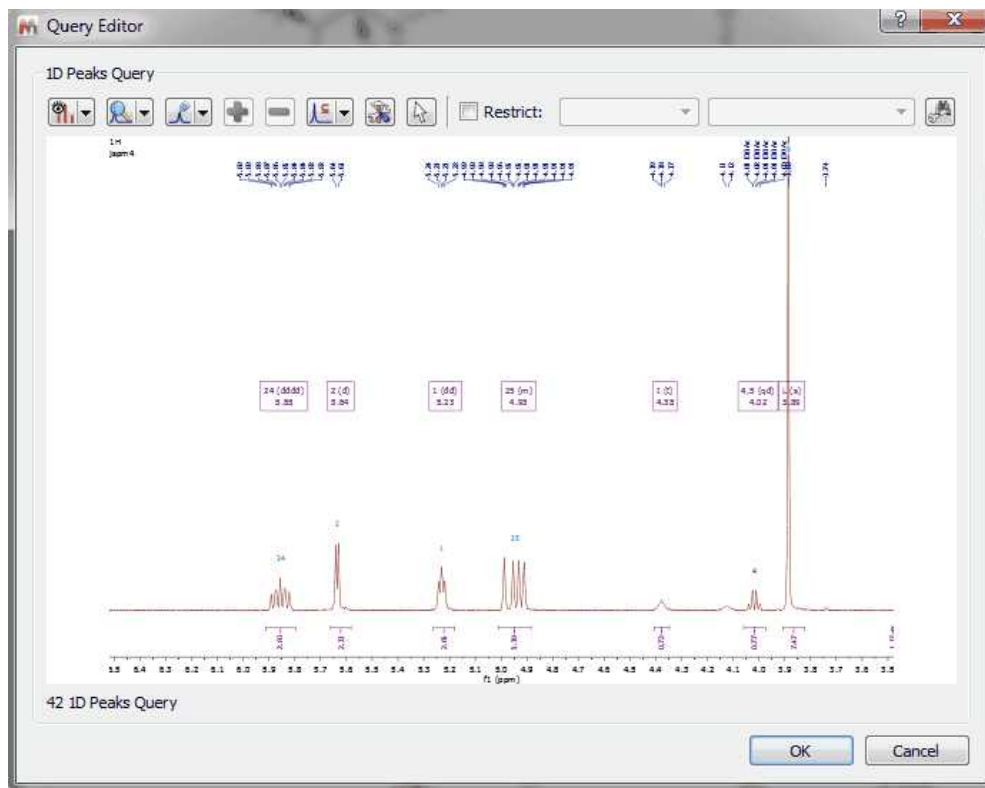

Clicking on the 'Convert to advance query' button  will allow you to convert it to an advanced search so that you can add new queries and combine them.

In the dialog box above, you will find a toolbar with different buttons:



- Select Display Mode: it will allow you to show the peaks table or the spectrum preview
- Peaks: to show 'All Peaks' or only 'Visible Peaks' of the expanded region
- Select Peaks by Compound: to search only for some specific compound peaks
- Add/Remove: To add or remove peaks from the table
- Purity/Mixture/Reverse:



The peak and multiplet search dialogs have a tool button for changing the search mode. The default mode is "Reverse", which penalize peaks which are in the query but not in the db spectrum. The default mode can be set in the user preferences.

The scoring by using 'reverse search' assumes that the sample is one compound and is based on how well a stored spectrum fits the total query. Peaks or multiplets that are in the query, but not in the stored spectrum, count against the score. This works well for spectra composed primarily of a single compound, but can lead to problems and excess "bad" hits when searching against a mixed sample. Another way that would be useful for binary, tertiary, etc. type mixtures would be a "content" score in which any potential hit is scored based on how well it's peaks compare back to the queried spectrum. To get a "1000" for a "content" score all peaks in the stored spectrum must be present in the queried spectrum, but there is no penalty for extra peaks in the query spectrum. It is almost a reverse grading of the spectra

For example: If you have a ~50:50 mixture of compound A and compound B and run a query, you get what would be approximately a "500" scores for both compounds using the traditional scoring method. If you were to additionally display the scoring method proposed above, each stored spectrum would get "1000" scores for a "content" grade. This way of scoring would better indicate the presence of particular compounds in the analyzed sample. This would also additionally help to completely rule out compounds that get low grades in the traditional scoring method, but show up in the scoring due to coincidental overlap of multiplets/peaks.

Purity Search: unclean spectra in the db (with many spurious peaks) will get low search scores.

Mixture means that peaks in the query spectrum but not the library spectrum will be ignored. This is for cases where the query spectrum might be a mixture containing additional compounds.

- Parameters: to set the 1D Peak Search Tolerances

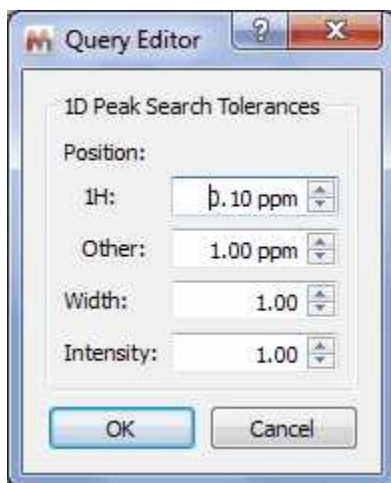

- Select from document: to select the spectrum if you are in a document with several datasets.

After having clicked on the OK button, the peak search will be run. In the example below, we have obtained a match for the compound number 25, with a score of 1000 (maximum value):

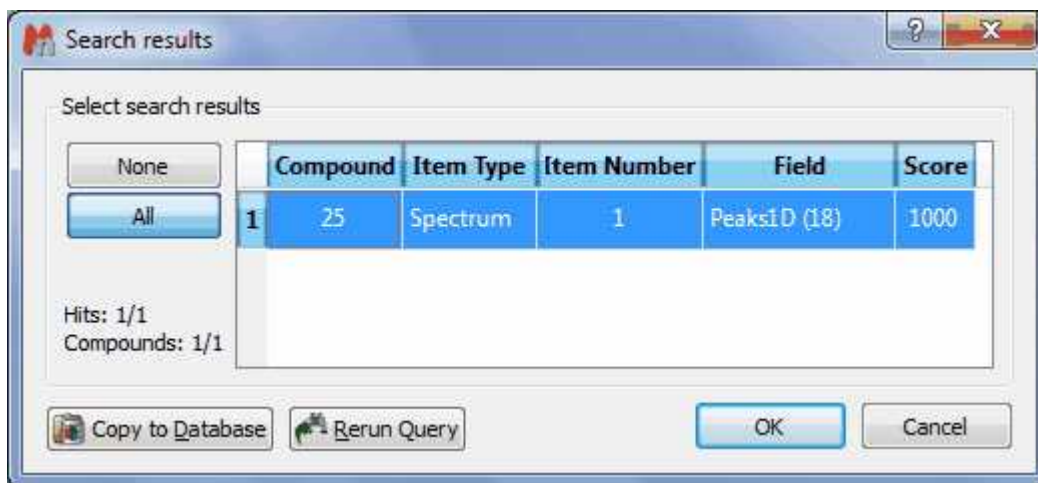

The Peak Search feature (combined or not with the Verification plugin) can be very useful to identify impurities in the datasets.

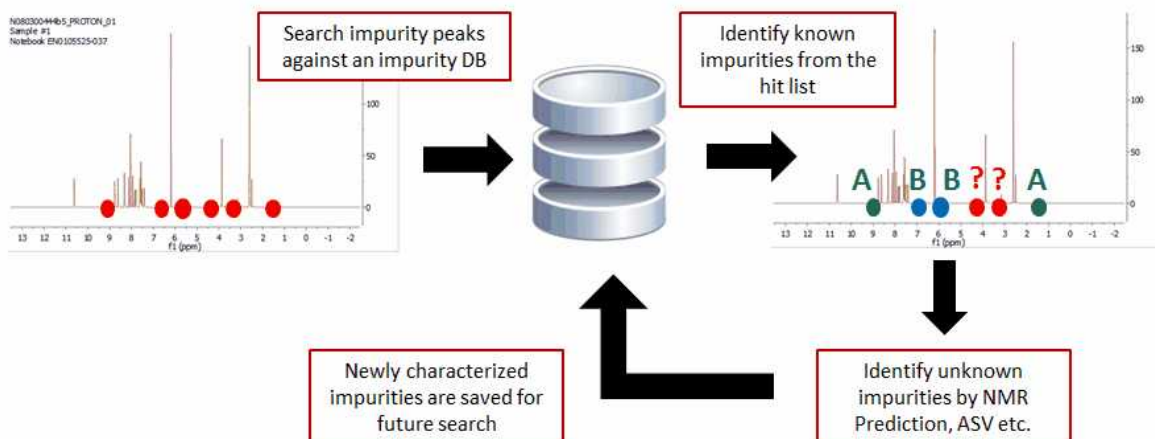

Please note, that you can also use the 'Peak Search' feature without any spectrum loaded. In that case, you will need to type in the table, the information of the peaks that you want to find in your database:

Query Editor

1D Peaks Query

Restrict:

	f1 from	f1 to	Width from	Width to	Intensity from	Intensity to
1						

1 1D Peaks Query

OK Cancel

Alternatively, you can also use the 'Peak Search' feature from a molecular structure with assignments:

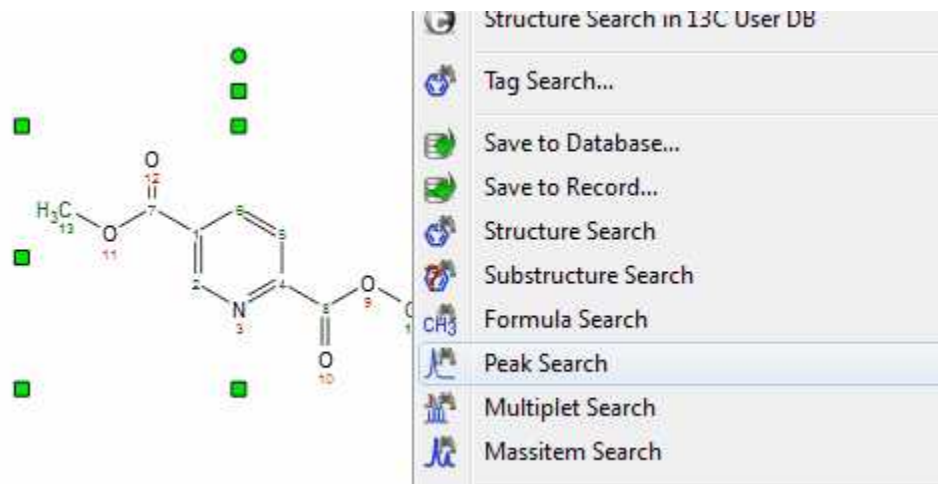

If your spectrum has more than one compound, you can run peak searches of only one of the compounds:

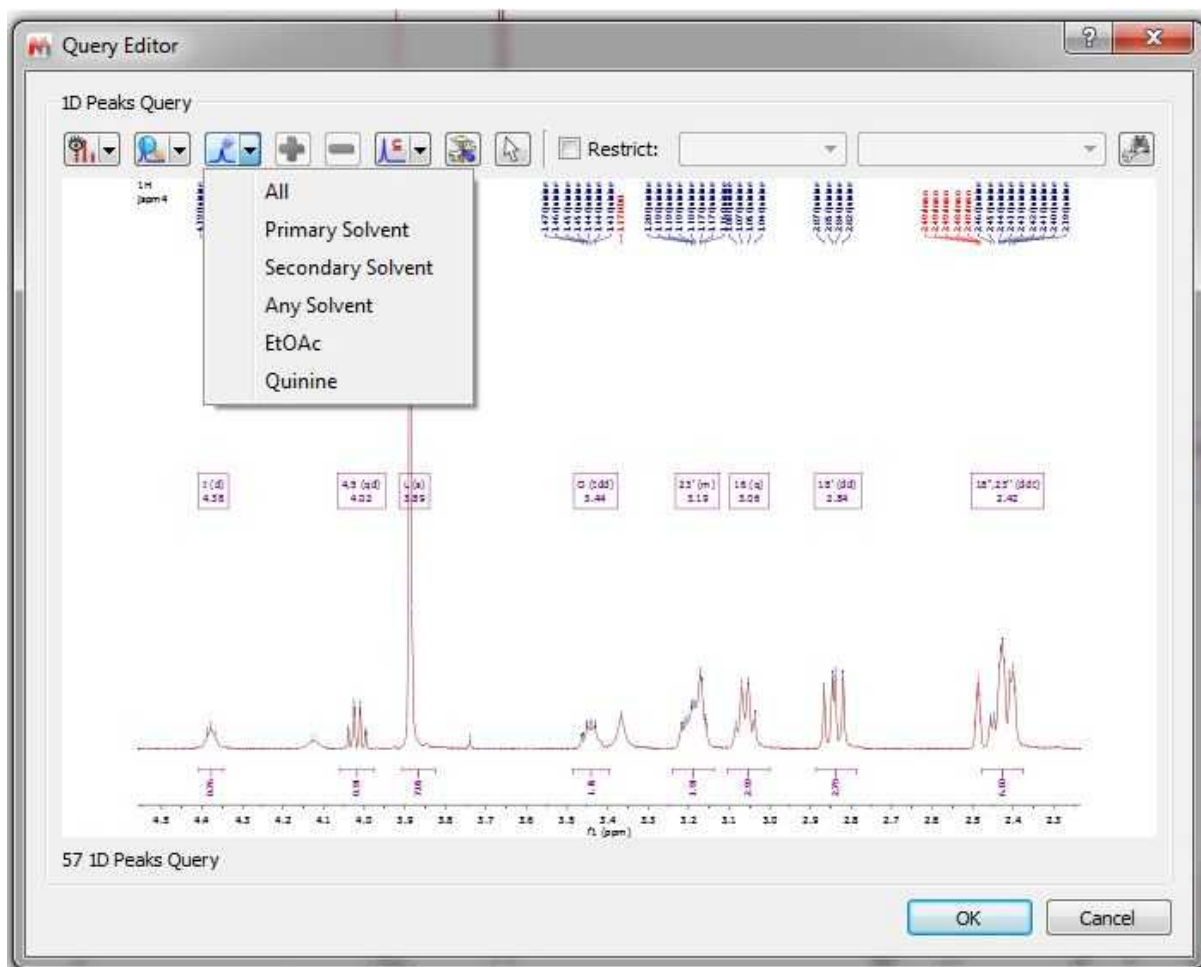

Multiplet Search

It will be also possible to search for multiplets. In this case, you will only need to open a spectrum with the desired multiplet analysis and finally select 'Multiplet Search' after having right clicked on the

spectral window:

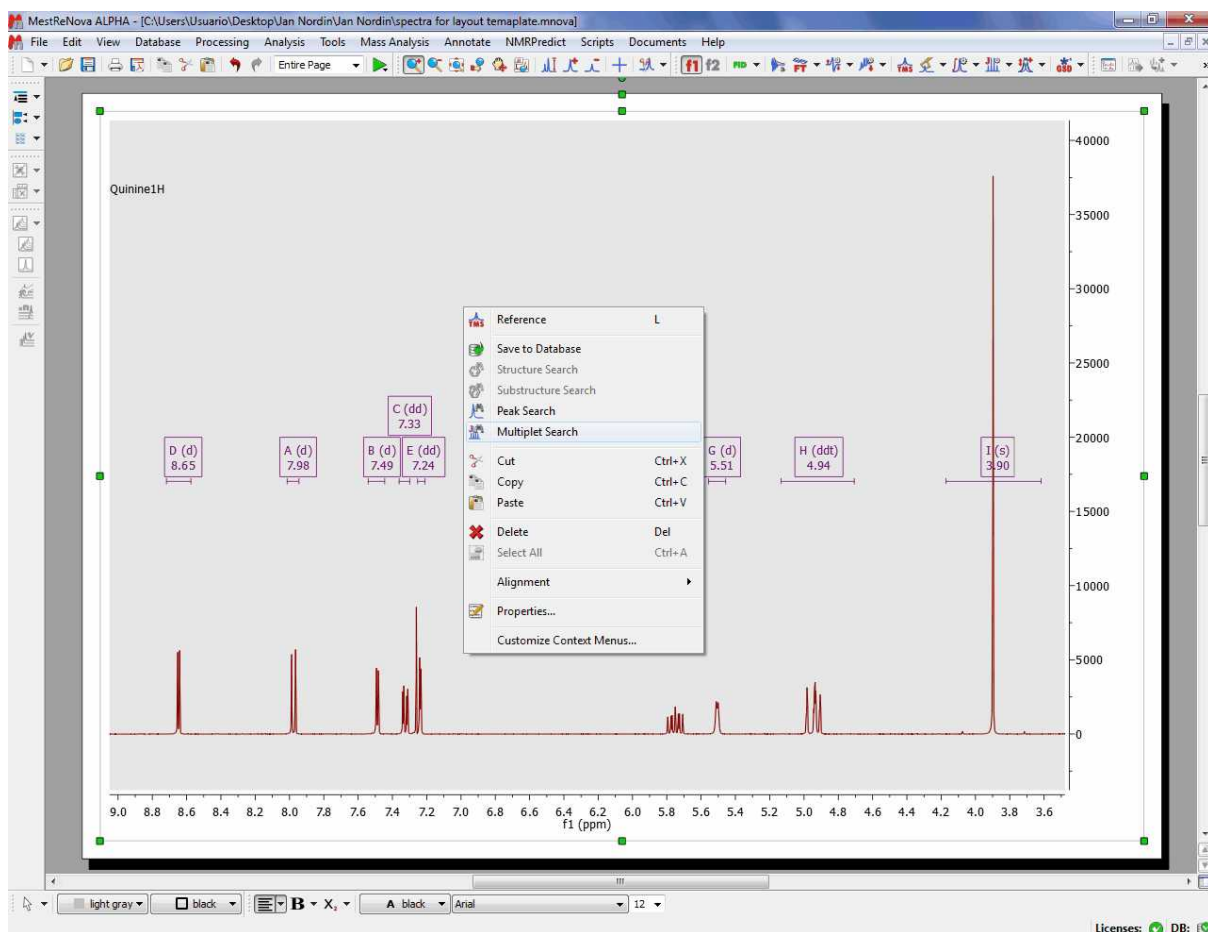

After that, the query editor will be displayed, to how you which multiplets will be searched. This dialog box is similar with the 'Peaks Query Editor' (explained above)

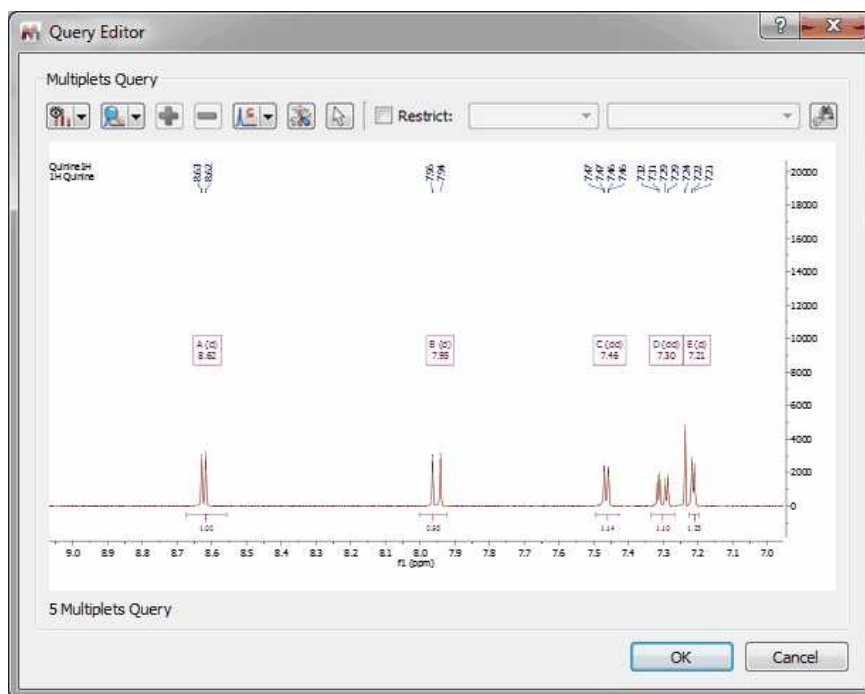

Mass Item Search

If you have a MS dataset loaded in Mnova and you select 'Database/Massitem Search' (or right click/MassitemSearch' or by clicking on the icon of the toolbar), the application will look for these MS peaks in the database.

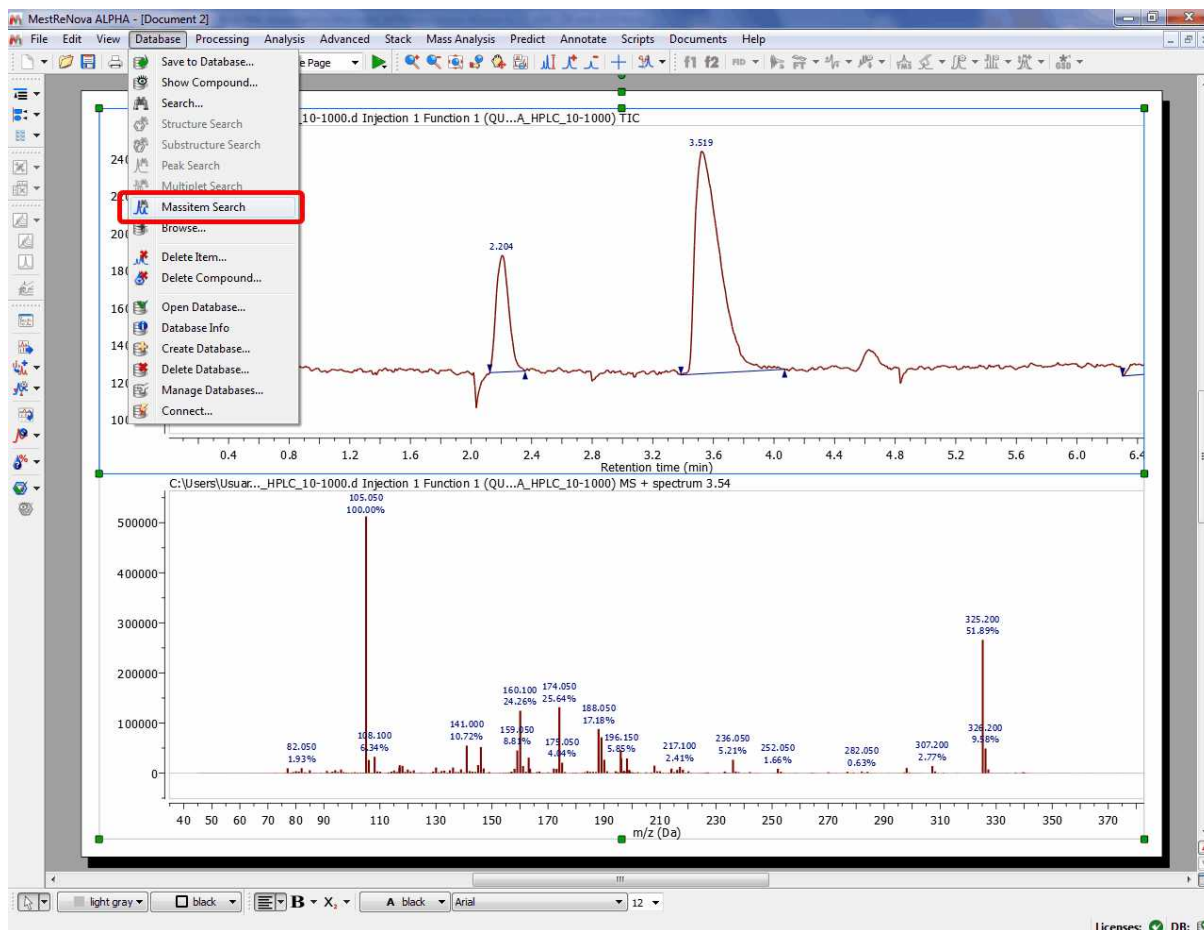

After having selected the 'Mass Item Search' feature; the query editor will be displayed:

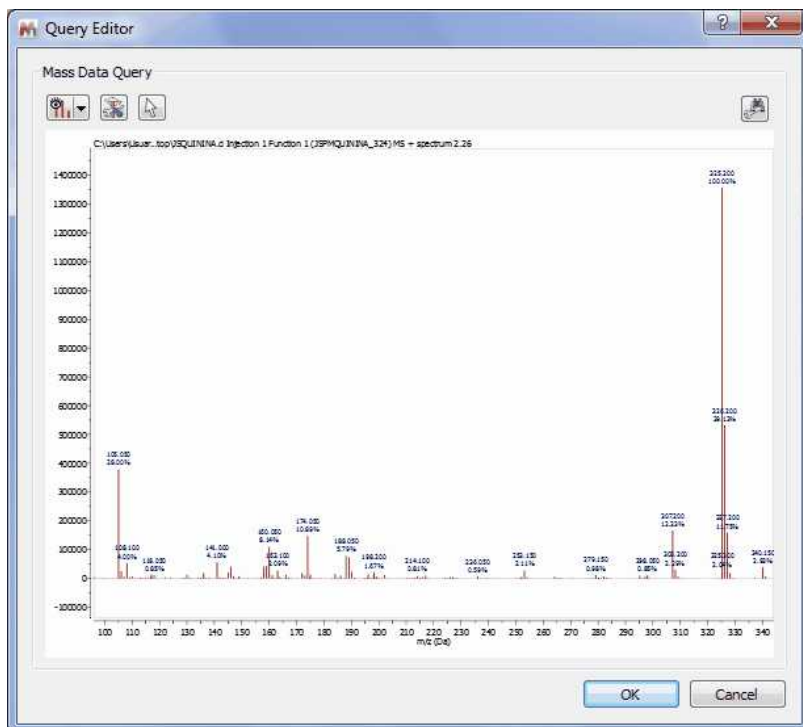

From here, you will be able to change the view (preview or plain text), or to select the tolerance of the Mass Item Searches.

Finally, click on the OK button and wait for the result:

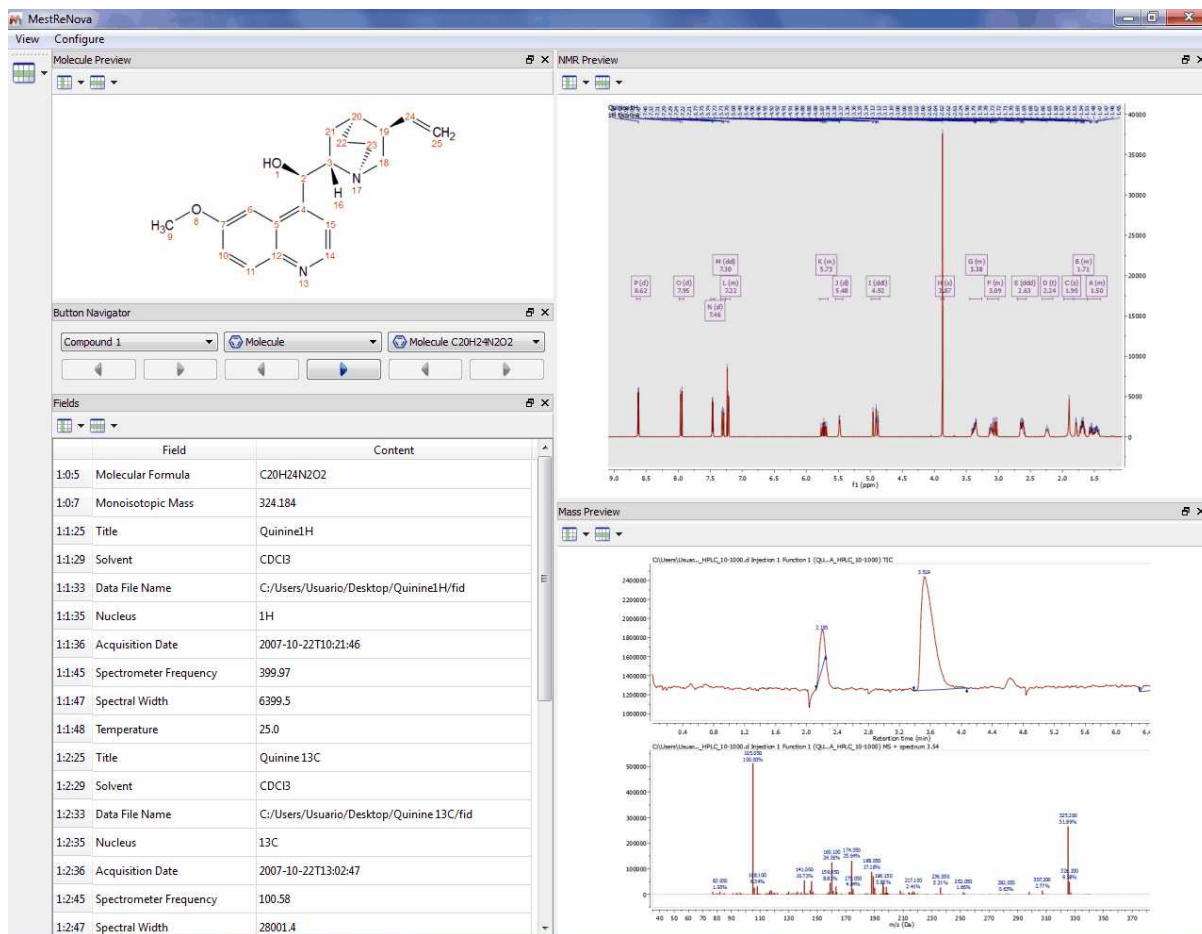

Numeric and Text Search

It will be possible to search for numbers or for any text in the database just by selecting one of these options

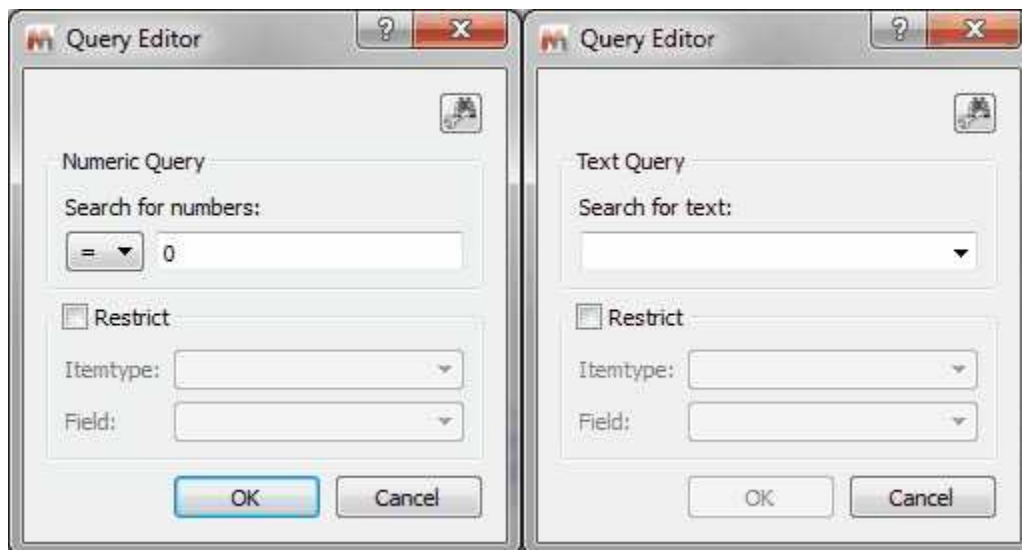

Please bear in mind that the numeric search can contain ranges like "10 < 20" or "10.2 <= 20.5".

It will be possible to search for all the items of your database just by typing "-" (without the quotation marks) in the search dialog.

Advanced Searches

This option will allow you to combine several queries (in the same document) for the same search. In the example below, you can see how we are combining the peaks of 1D and 2D NMR datasets with the Mass spectrum.

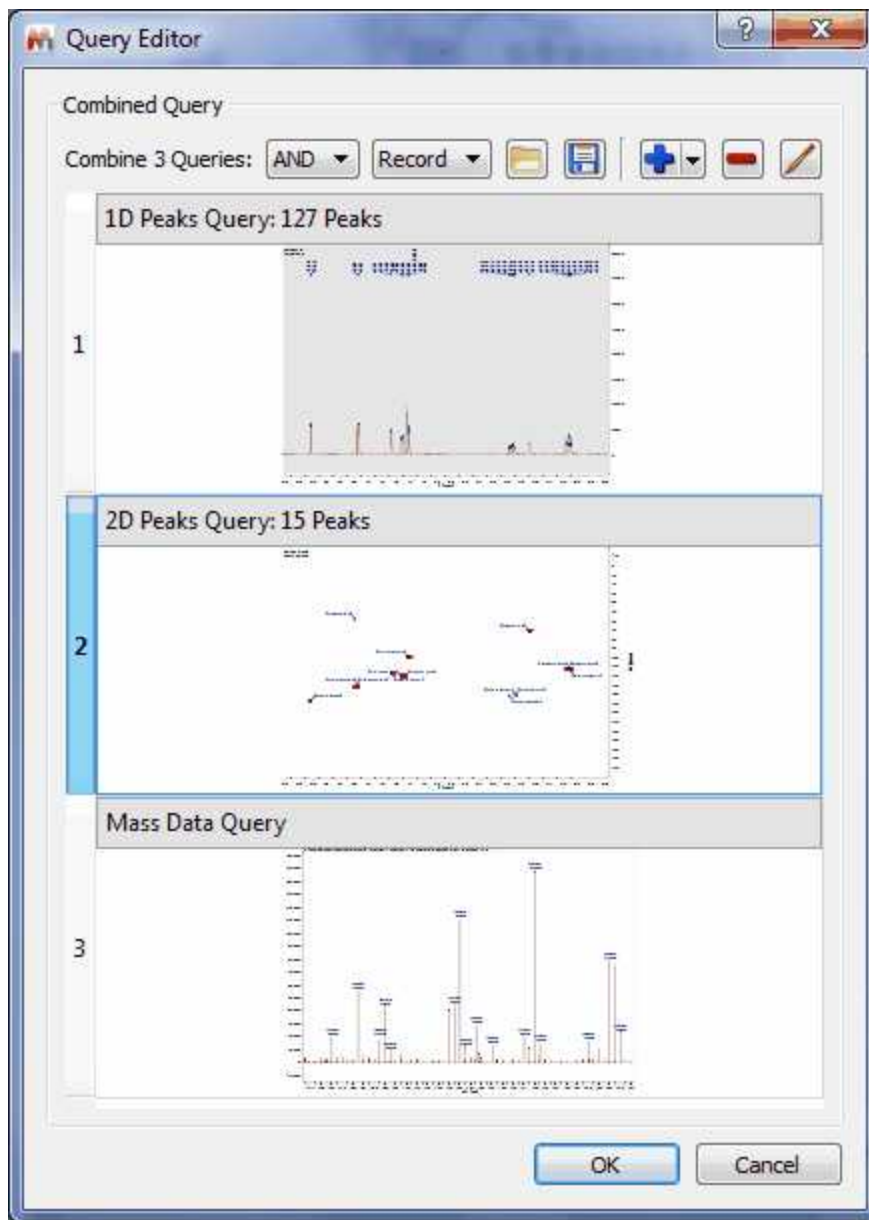

It will be possible to look for any of the 3 queries (by selecting 'OR' in the applicable scroll down menu) or for all the queries (by selecting 'AND'). You can also load/save combined queries in XML format, or to add/remove/edit the queries by using the applicable buttons of the dialog box.

15.5 View Results

Once you have searched your items in the database, you will get this view by default with the results:

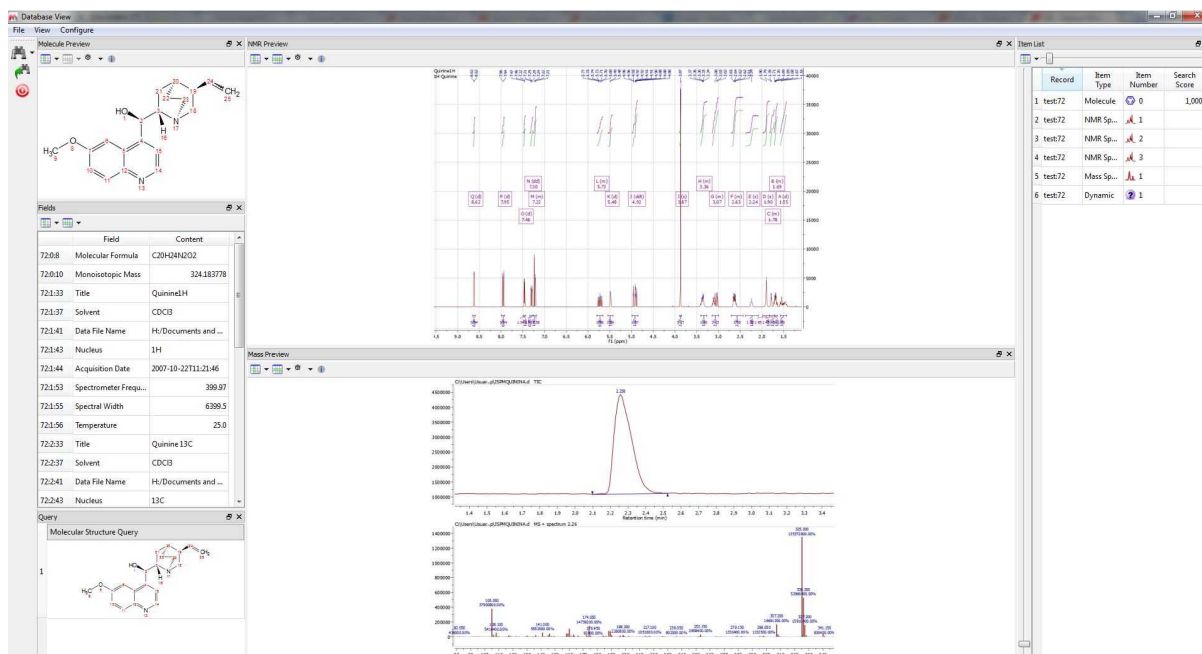

As you can see, you will get the molecular structure, a table with several fields, the query window, spectral views and the item list to change the compound or the spectrum of the preview (just by clicking on the applicable item of the list).

You will also find a couple of buttons  to select the 'display mode' and to 'show the reference information'.



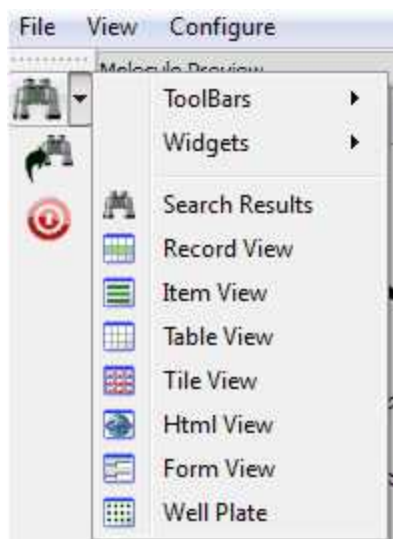

This is the template called 'Search Result', but there are several templates by default which you will find by following the 'View' menu (or by clicking on the 'binoculars' scroll down menu):

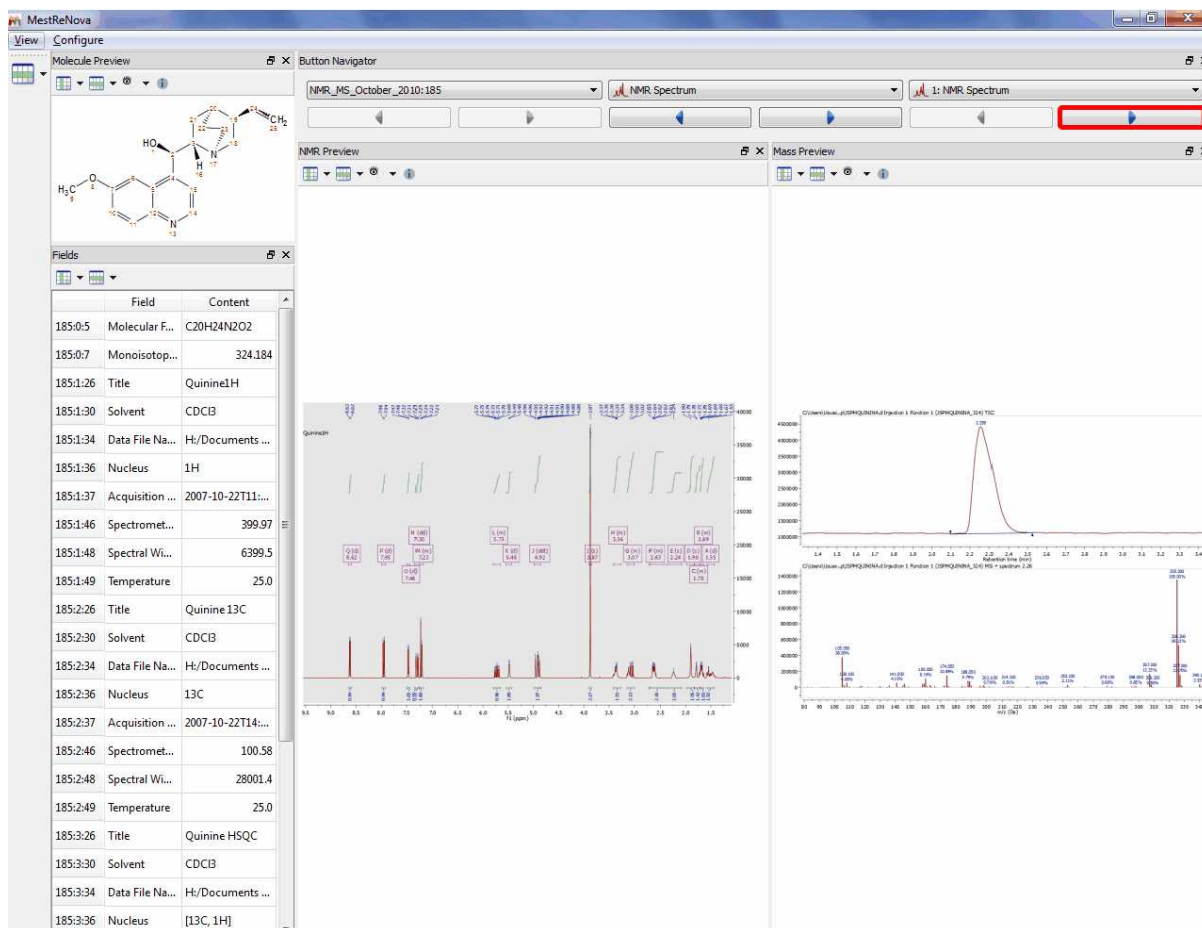

Here you can see for example the 'Record view', with information about molecular structure, a table with several fields, a spectral view and a button navigator to change the compound or the spectrum of the preview.

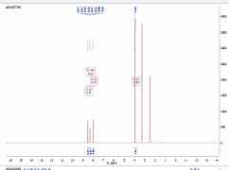

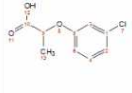
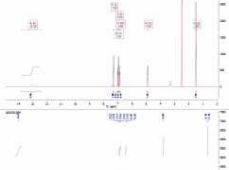
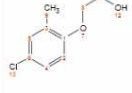
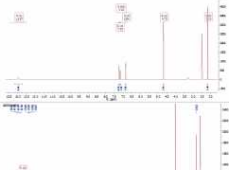
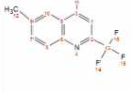
Here you can see the Table view, with information about the compound ID, molecular Formula, Molecular Preview, Title, Solvent, Nucleus, Frequency and Spectrum Preview.

	Molecular Formula	Preview	Title	Solvent	Nucleus	Spectrometer Frequency	Preview
1	Compound1 C8H6BrNO4		LS00027756	DMSO	1H	700.03	
2	Compound 2 C8H6BrNO4		LS00012648	DMSO	1H	700.03	
3	Compound 3 C9H9ClO3		LS00026358	DMSO	1H	700.03	
4	Compound 4 C9H9ClO3		LS00021274	DMSO	1H	700.03	
5	Compound 5 C11H7ClF3N		LS00014404	DMSO	1H	700.03	

Of course you can add additional information to the table view just by clicking on the 'Select Visible Fields' icon  :

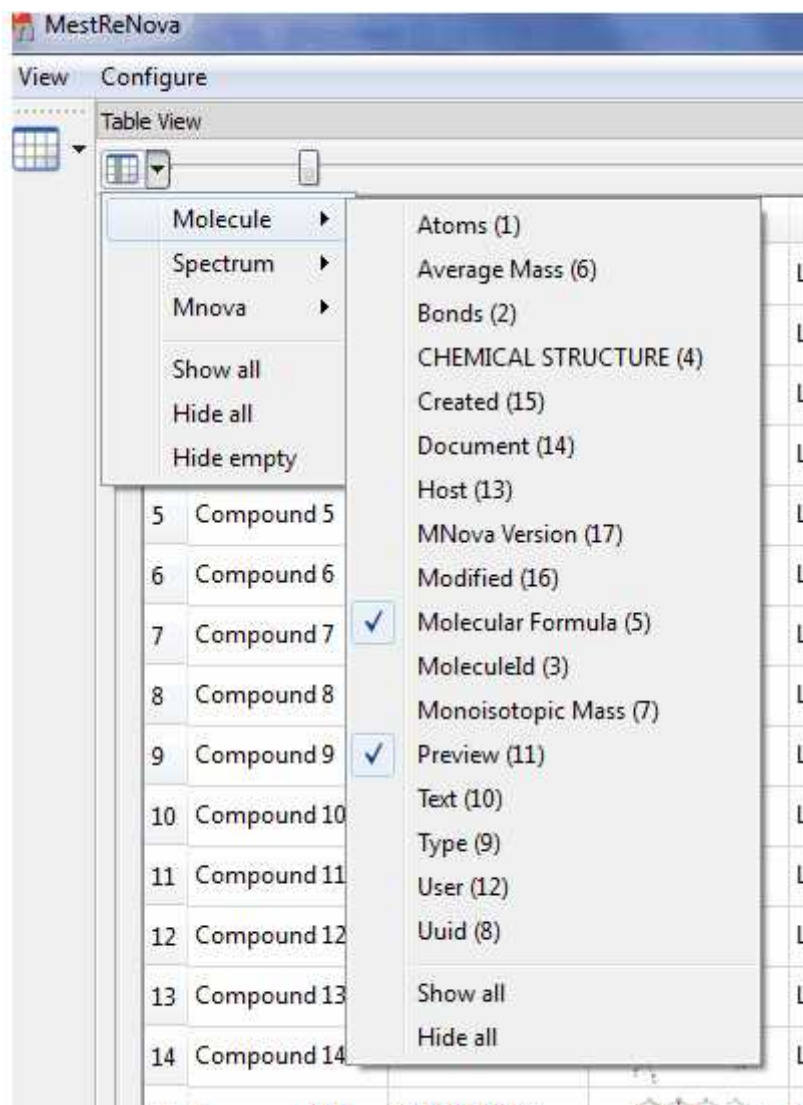

You will find below the HTML view:

The screenshot displays the MestReNova software interface. On the left, a 'Tree Navigator' shows a list of compounds from Compound 1 to Compound 25. Compound 25 is selected, and its details are shown in the main window. The 'Compounds List' section shows 'Compound 25' with a 'Molecule' item type. Below this, a table lists fields and their content for the molecule. A chemical structure is shown in the 'Preview' section. Below the molecule table, another table shows fields and content for the 'Spectrum' item type. A spectrum plot is shown in the 'Preview' section for the spectrum. Below the spectrum table, another table lists fields and content for the spectrum.

Field	Content
Itemtype	Molecule
Id	0
Preview	237 x 131
Previewx	948 x 521
Molecular Formula	C ₂₀ H ₂₄ N ₂ O ₂
Average Mass	324.417
Monoisotopic Mass	324.184

Field	Content
Itemtype	Spectrum
Id	1
Preview	156 x 127
Previewx	1244 x 1011
Title	Quinine1H
Solvent	CDCl ₃
Data File Name	H:/Documents and Settings/Usuario/Escritorio/Quinine1H/fid
Nucleus	¹ H
Acquisition Date	2007-10-22T11:21:46
Spectrometer	399.97
Frequency	399.97
Spectral Width	6399.5
Temperature	25.0

If you have used the Verification plugin to build your database, then you will find useful the 'Well Plate View' which will contain information about the Verification results (by using the typical color code for the plates; green for a good verification result, yellow for a doubt and the red for a bad result in the verification).

Clicking on any of the plates, will show the corresponding molecule, spectrum and table of fields. Double clicking on the plate will copy all the information to Mnova as a new document. Right clicking on the well plate (or on several) will allow you to 'Paste the item(s) or the compound(s) to Mnova' or to 'Update the ¹H or ¹³C Prediction [Database](#)':

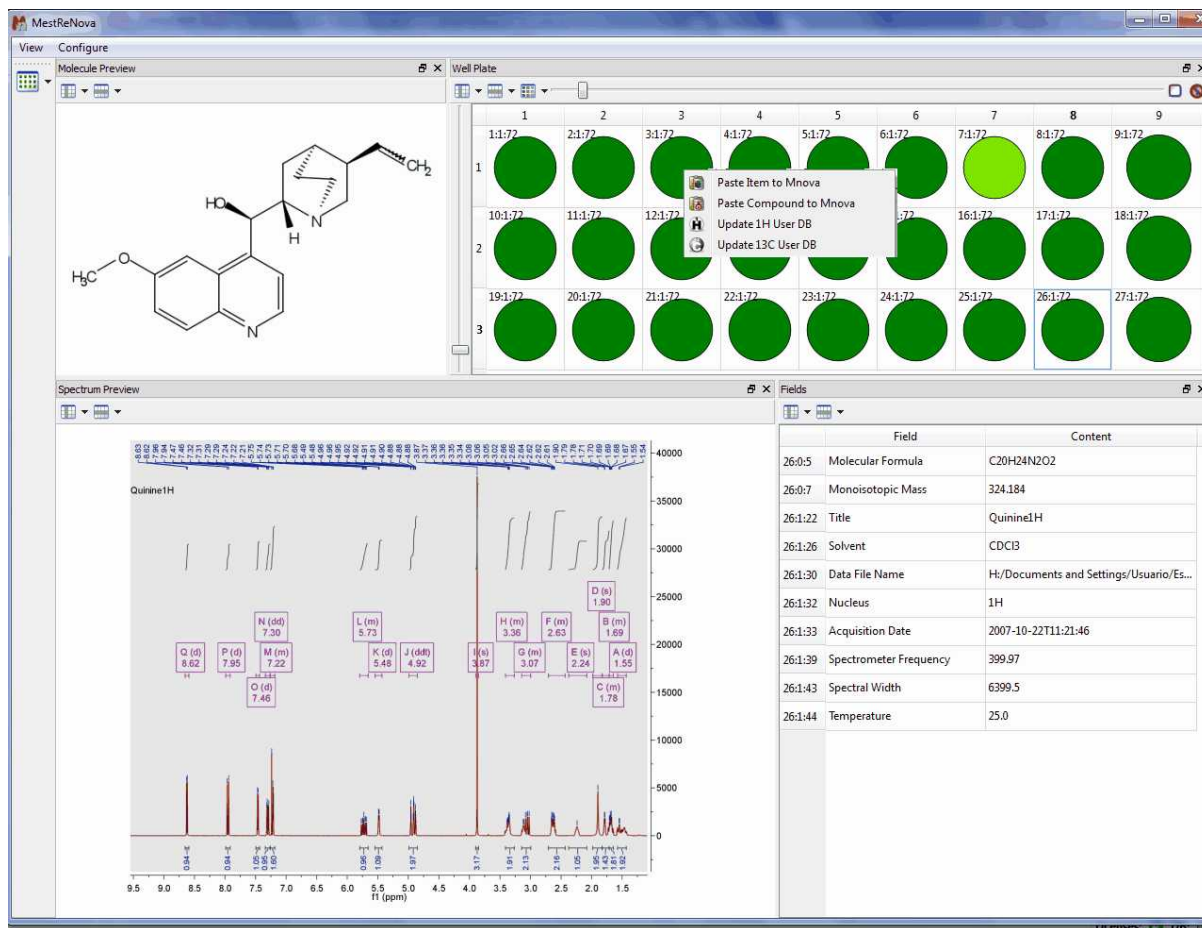

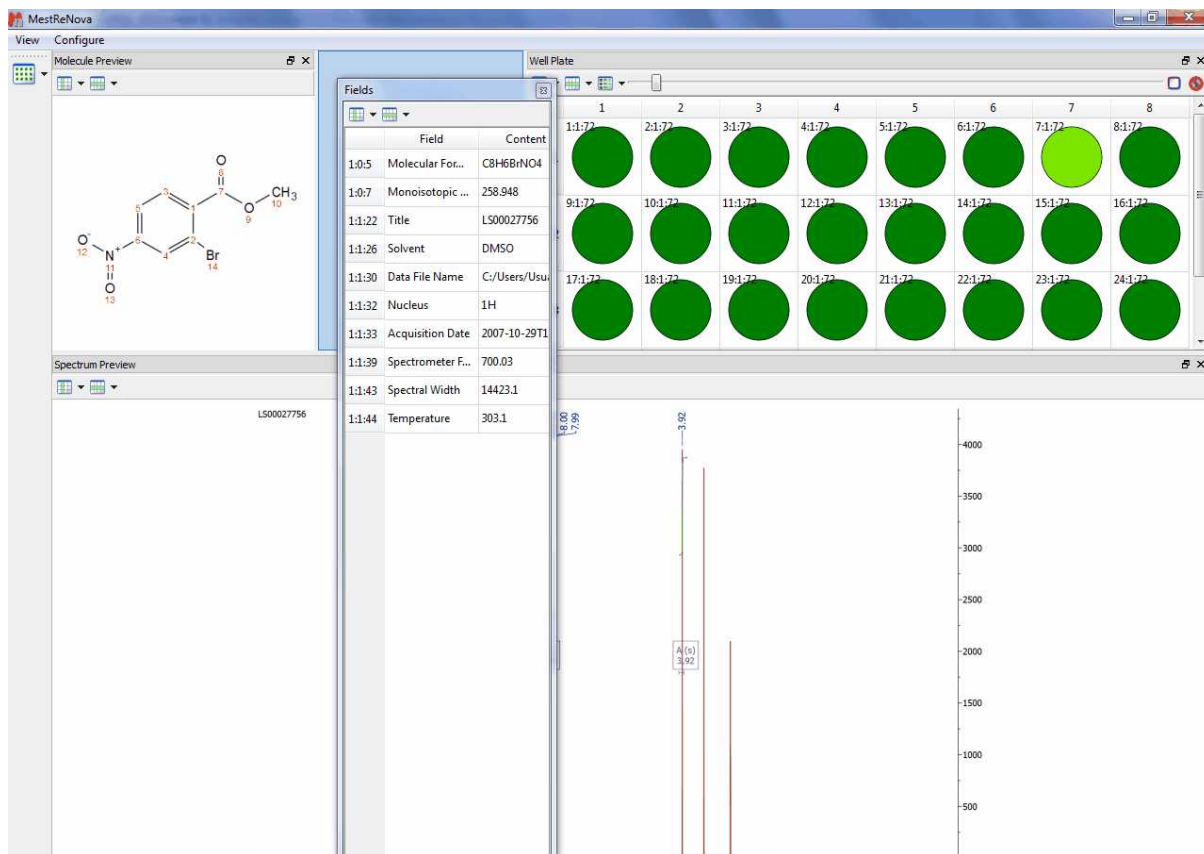

Of course the user will be able to freely customize any of the templates or even create their own ones. All the objects are linkable and the user will be able to change its position by just clicking&dragging. In the example below, we are changing the location of the 'Fields' table:

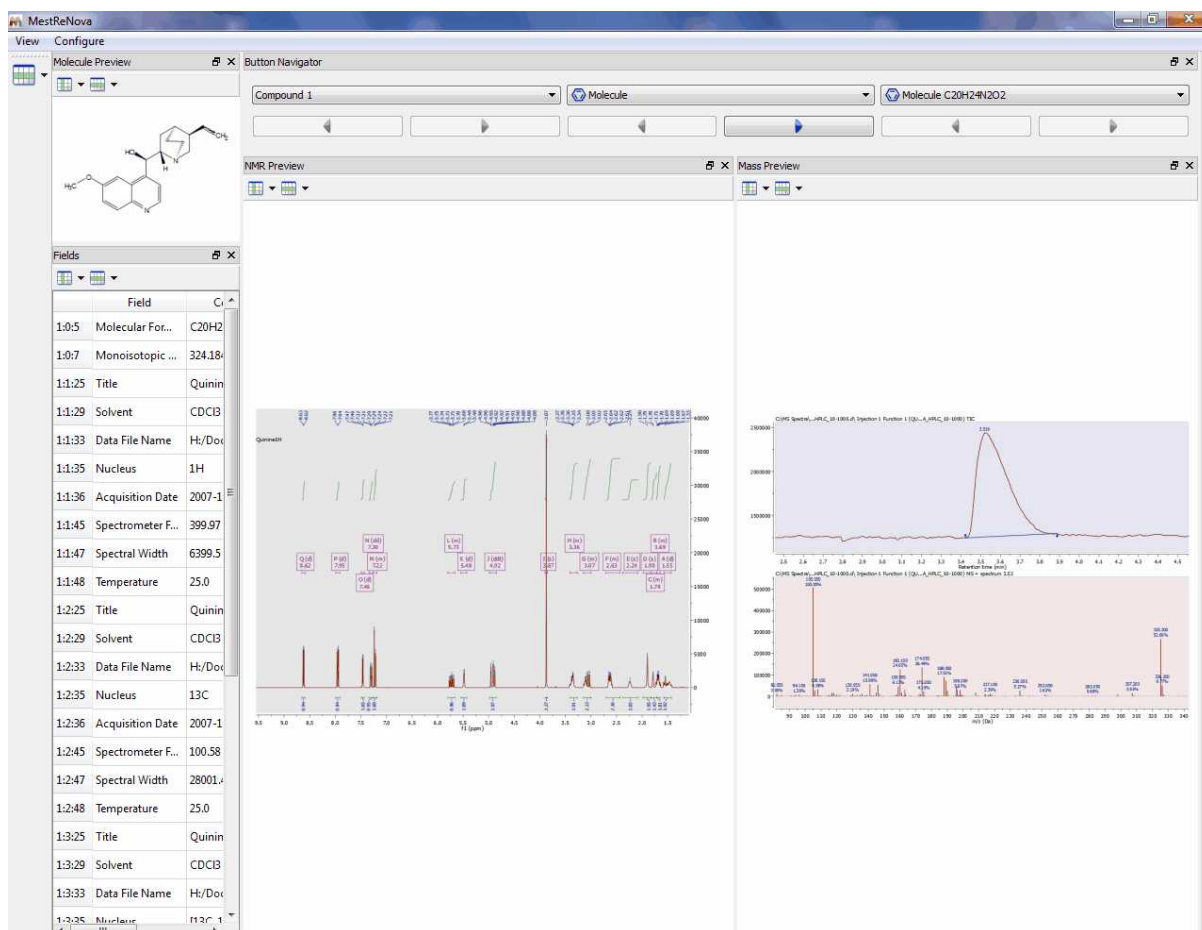

In the example below, we are showing a template with 1H and MS datasets.



To create it, we have used the default 'Record View' template and added the MS preview by following the menu 'Configure/Add Widgets/Preview'. Once the new 'Preview' has been created, we have selected 'Mass Spectrum/Preview' after having clicked on the 'Select Field' button .

In addition the user will be able to customize the 'Views' by adding/changing information of the 'Previews' or 'Tables' boxes (with these couple of buttons .

Even, the user will be able to create his own new templates (or customize the existing ones) by following the menu 'Configure':

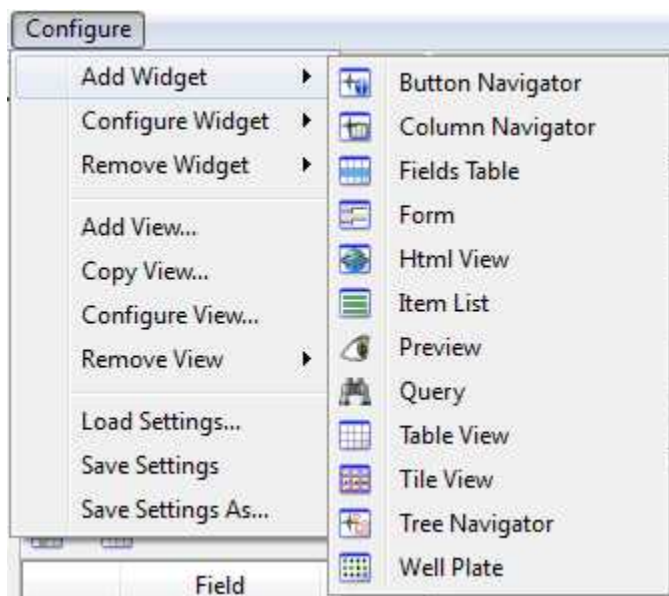

From here, the user will be able to add configure and remove widgets (such as 'button, column or tree' navigators, Fields Tables, Previews, etc...). From this menu it will be also possible to Add/Copy/Configure or remove views or to load/save the settings of different templates.

If you want to show the original spectrum or molecule that you used for the search, you will need to add the 'Query' widget and you will be able to compare the query spectrum with the hits from the database.

Here you can see another example combining NMR, MS and well plates:

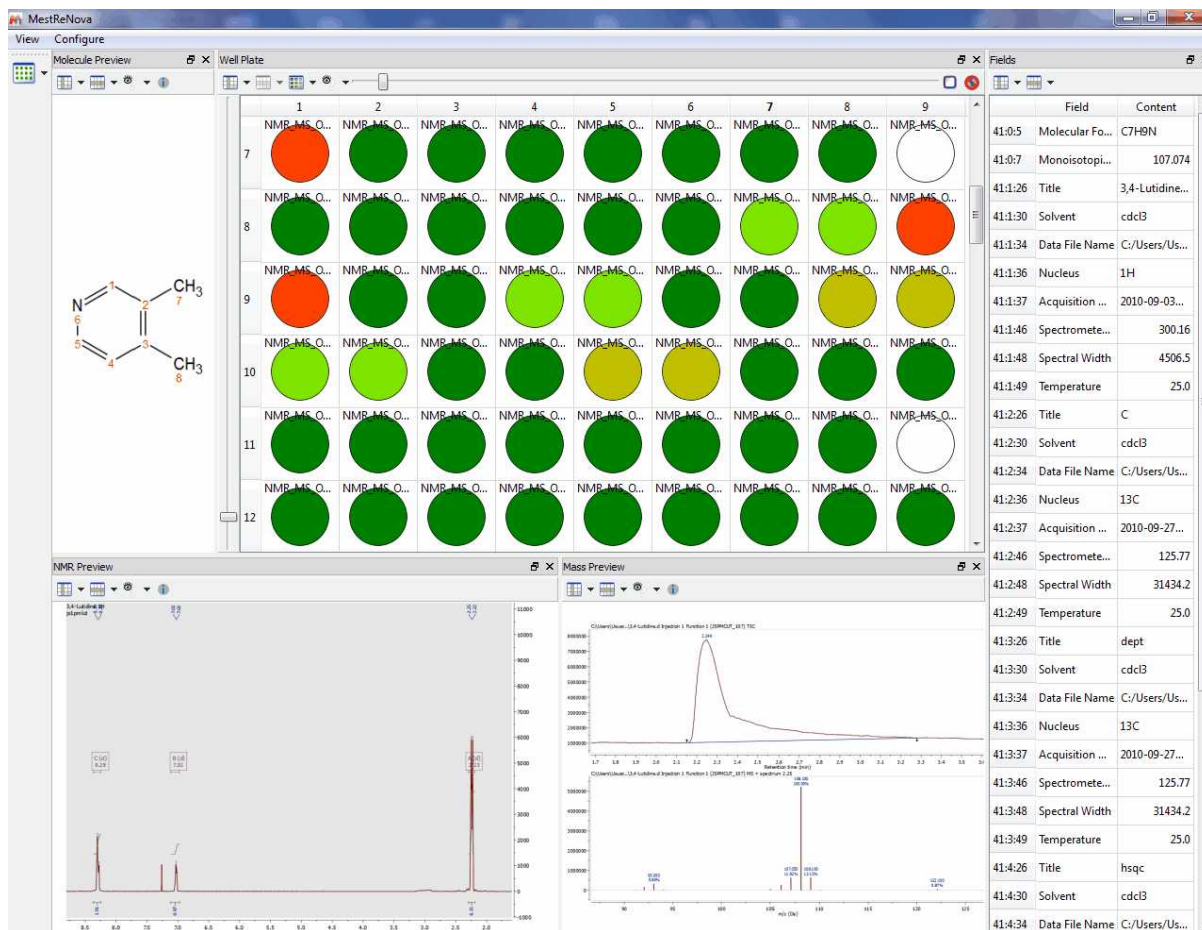

15.6 Deleting items/Records

The user will be able to delete items or records by using these options of the menu:

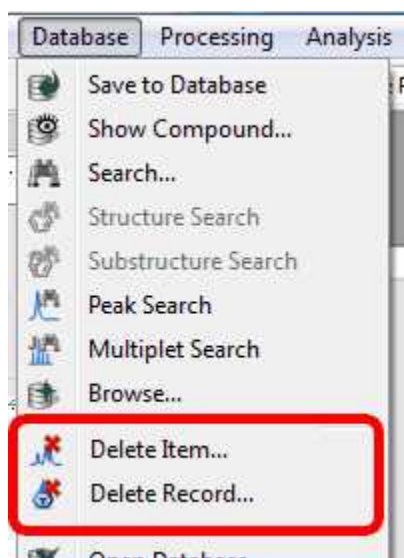

Clicking on the 'Delete Item' option, will display a new window with some edit boxes to fill with the

information (Compound, Type and number) about the item that the user wants to delete. In the example below, it is shown how to delete the Spectrum 1 of the compound 2:

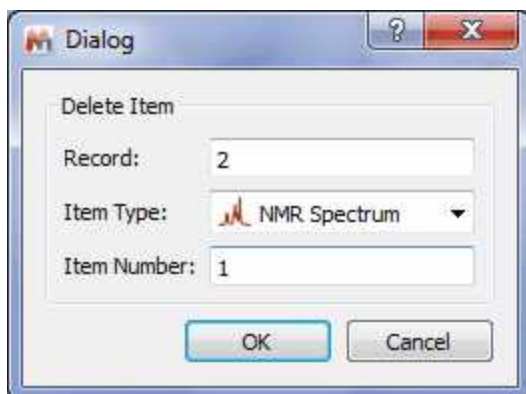

In the same way, it will be possible to permanently delete a record:

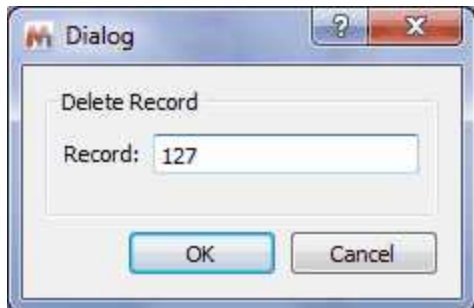

15.7 User Preferences

It is possible to select set up the preferences for the DB plugin, just by following the menu 'Edit/ Preferences' and selecting DB:

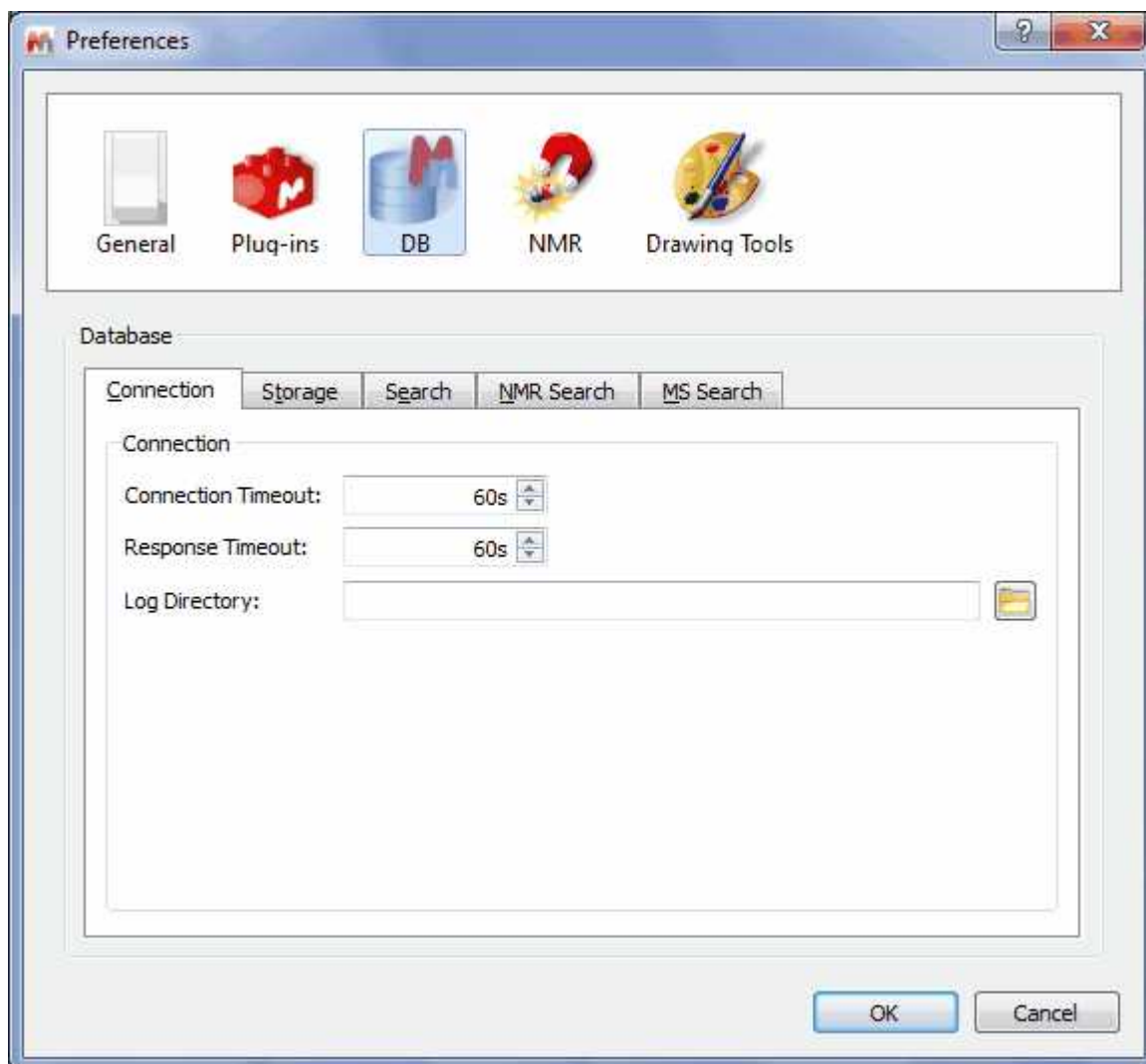

From here it will be possible to select the number of seconds to wait for a connection or response with the server or the path to store the packet log file.

Selecting the Storage label, will allow you to select the resolution of the 'Previews' and to load layout templates (which will be applied when you copy items or compounds from the DB to Mnova). Unchecking the 'Show Data Dialogs' will disable the pop-up windows (to introduce additional information) which appear when you are uploading MS datasets to the database.

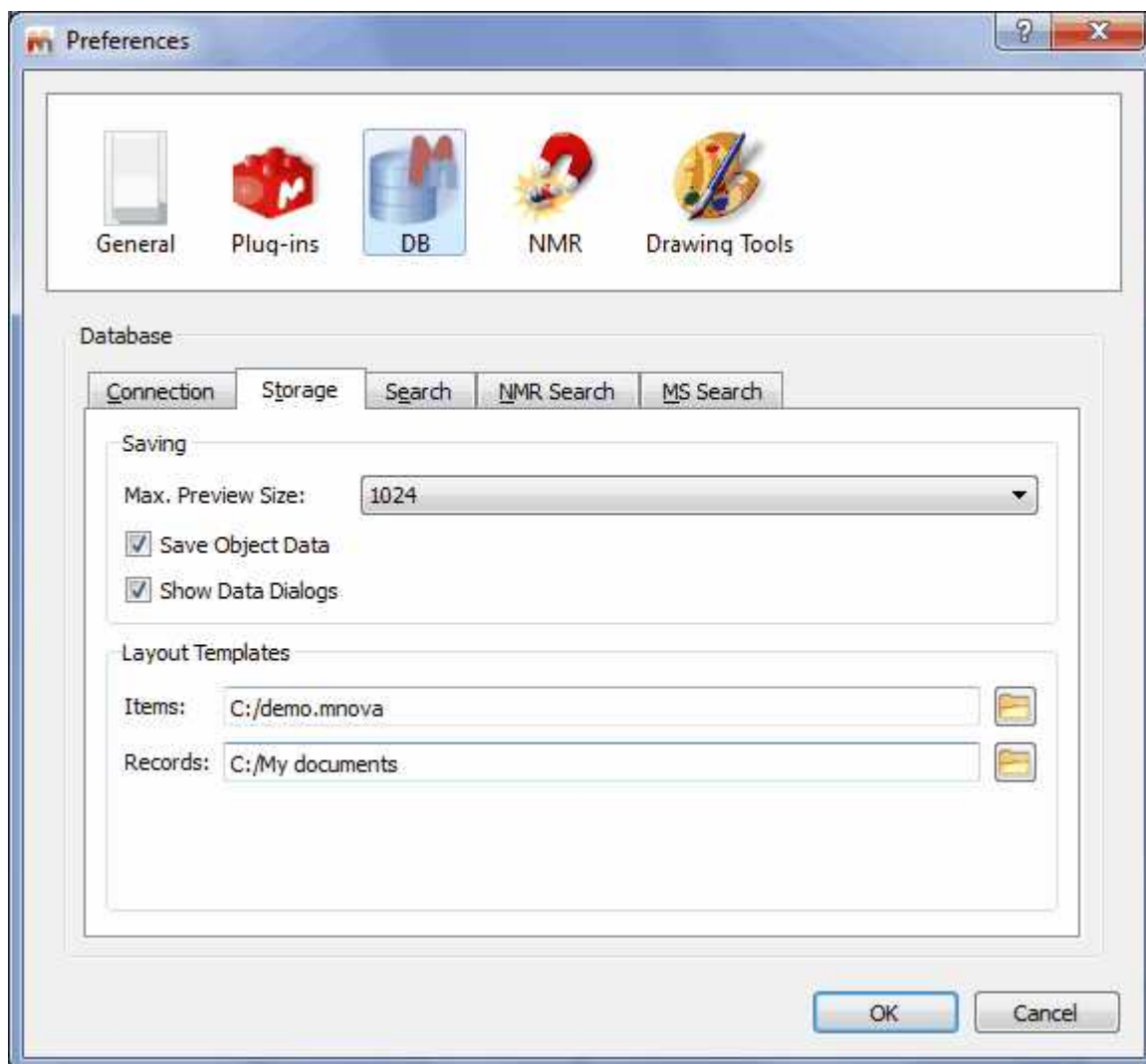

From the Search label, the user will be able to select the maximum number of hits or compounds returned by a search or the 'Preselection Threshold' (the minimum number of search hits for preselection dialog to be shown).

It will be also possible to select the minimum score for Peaks, multiplets or free search hits to be included in the results. If for example you are searching for 3 peaks and Mnova DB finds spectra with 2 of the 3 peaks, then the score will be 666.

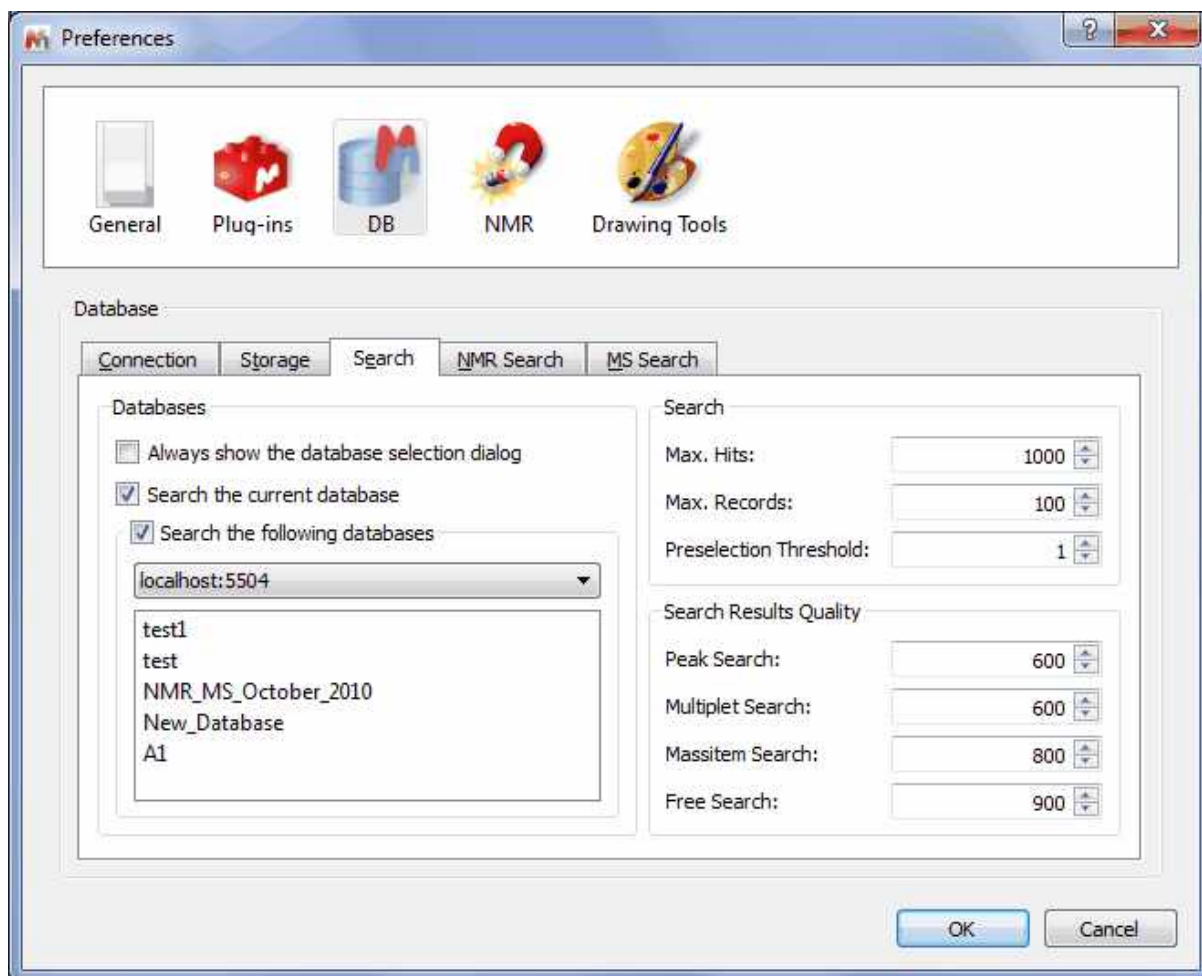

From the NMR Search label, you can set the Peak and multiplet search tolerances and select the desired databases to search.

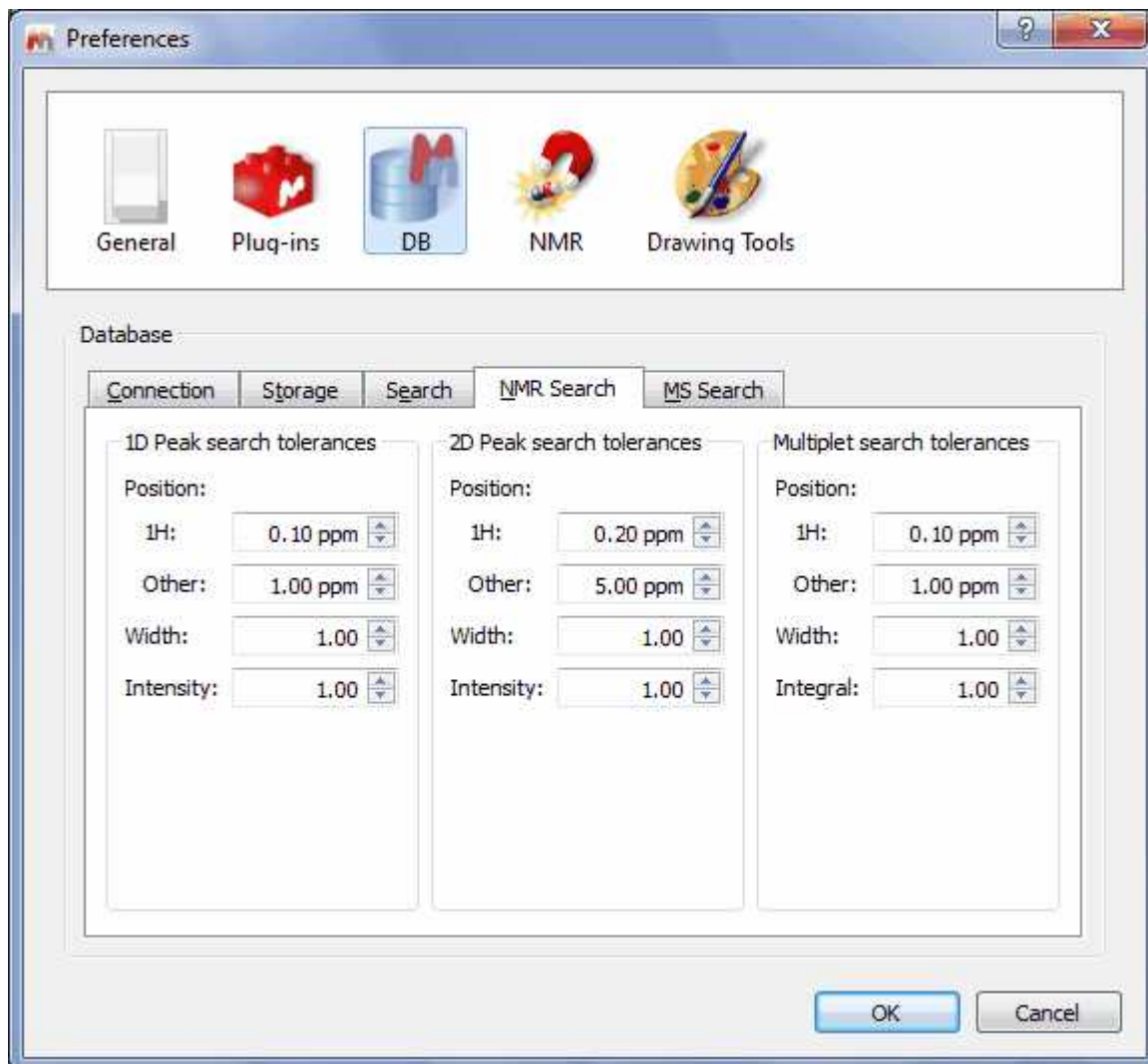

From the MS Search, you can select the *Scoring type* (purity, mixtures or reverse) and *tolerance*.

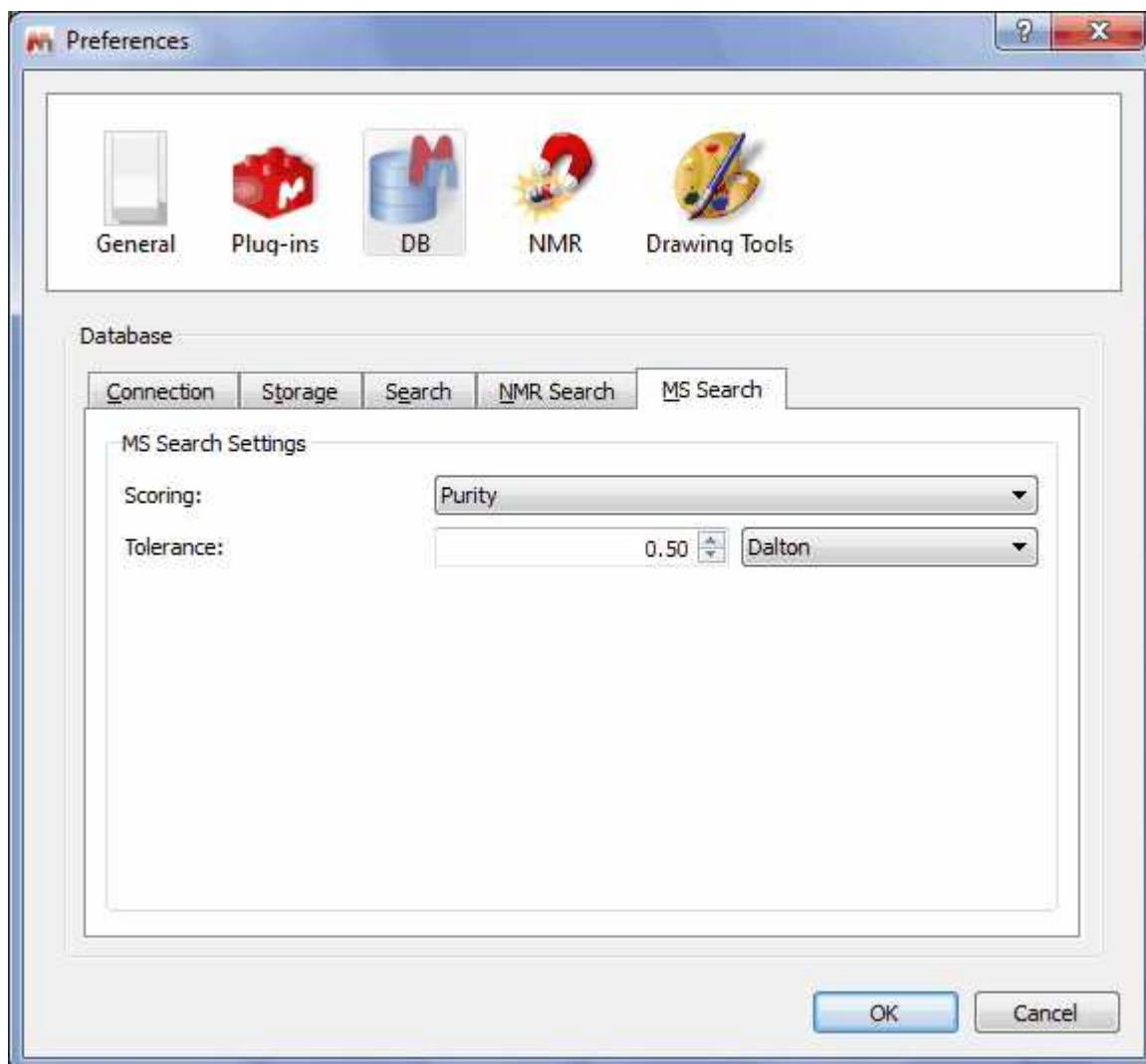

The purity setting will take into account all mass peaks in both the unknown spectrum and library spectra.

Mixture means mass peaks occurring in the unknown spectrum but not the library spectrum are ignored. This is for cases where the unknown spectrum might be a mixture containing additional compounds.

Reverse is the opposite of mixture - mass peaks in the library spectrum that don't occur in the unknown spectrum don't lower the score. This is like saying my unknown spectrum is better than the library spectrum.

Tolerance - m/z tolerance in Da or ppm. Most commonly, MS acquisition is done with "nominal mass accuracy", where the m/z values are only accurate to 0.1 to (say) 0.3 Da. In this case, a tolerance in Da of 0.5 is sensible. High accuracy acquisition can produce mass spectra with m/z accuracy to 10 ppm or better. In that case, the user might select a mass tolerance of 20 ppm.

15.8 Managing Databases

It will be possible to manage the Databases from the Database menu:

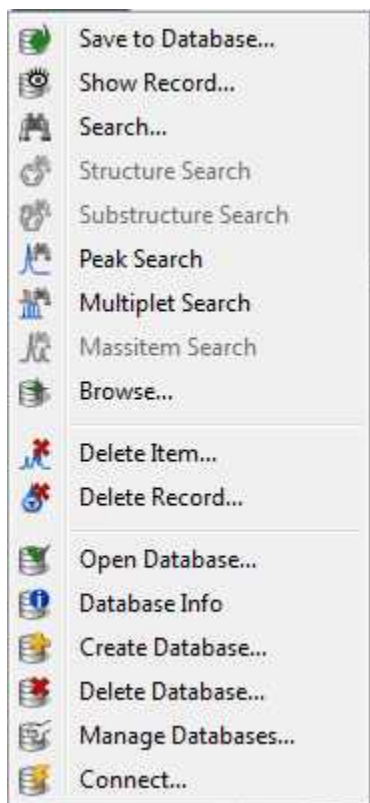

You can create a new database just by following the menu 'Database/Create Database' to display the dialog box below:

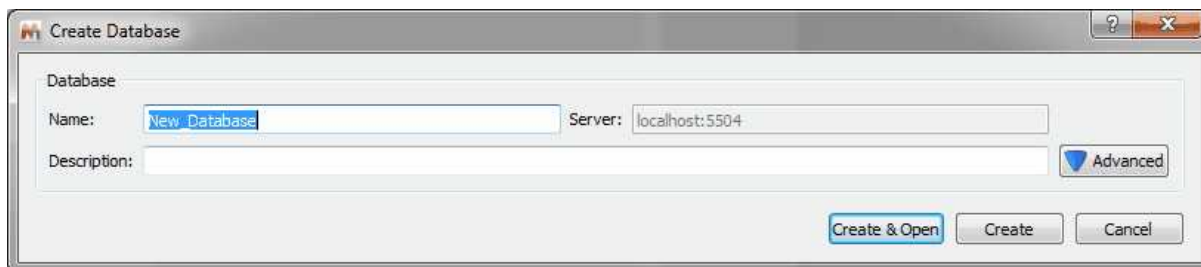

Click on the 'Advanced' button to customize the options of your Database:

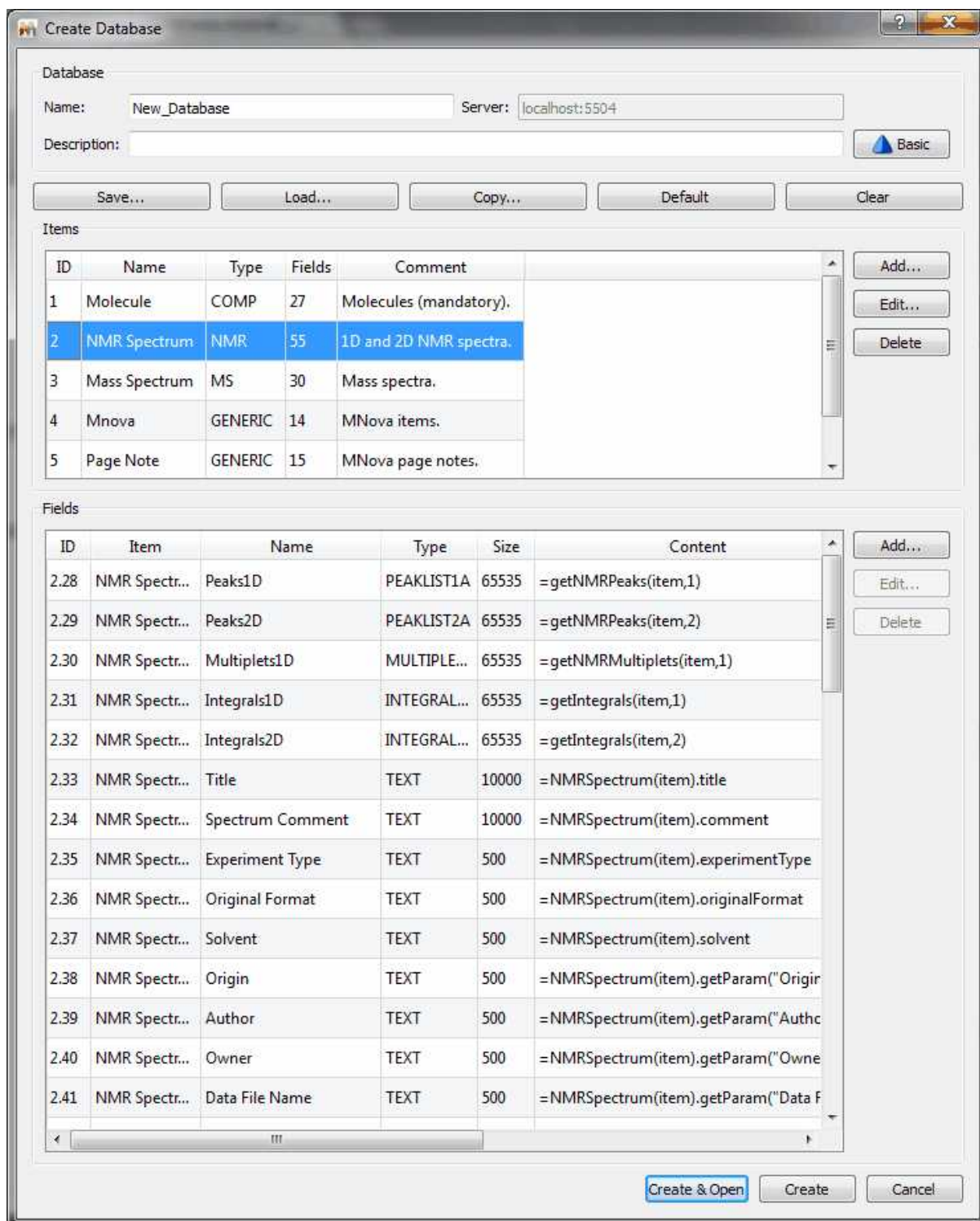

From here, it will be possible to define several fields for each object just by using small scripts (after having clicked on the 'Add...' button of the Field menu). For example in the example above, you can see how we have defined 40 fields for the object 'Spectrum', such as 'Peaks1D', 'Peaks2d', 'Multiplets1D', 'Title', etc. You can also get the information of the Database (showed in the picture above) just by following the menu 'Database/Database Info'

Of course it will be also possible to add new items, edit the existing ones or delete them, just by using the corresponding buttons.

For example, if you want to add a new field, you will need to click on the 'Add' button to add a new field. For example, let's add a 'text' field called 'CAS NUMBER' in a molecule:

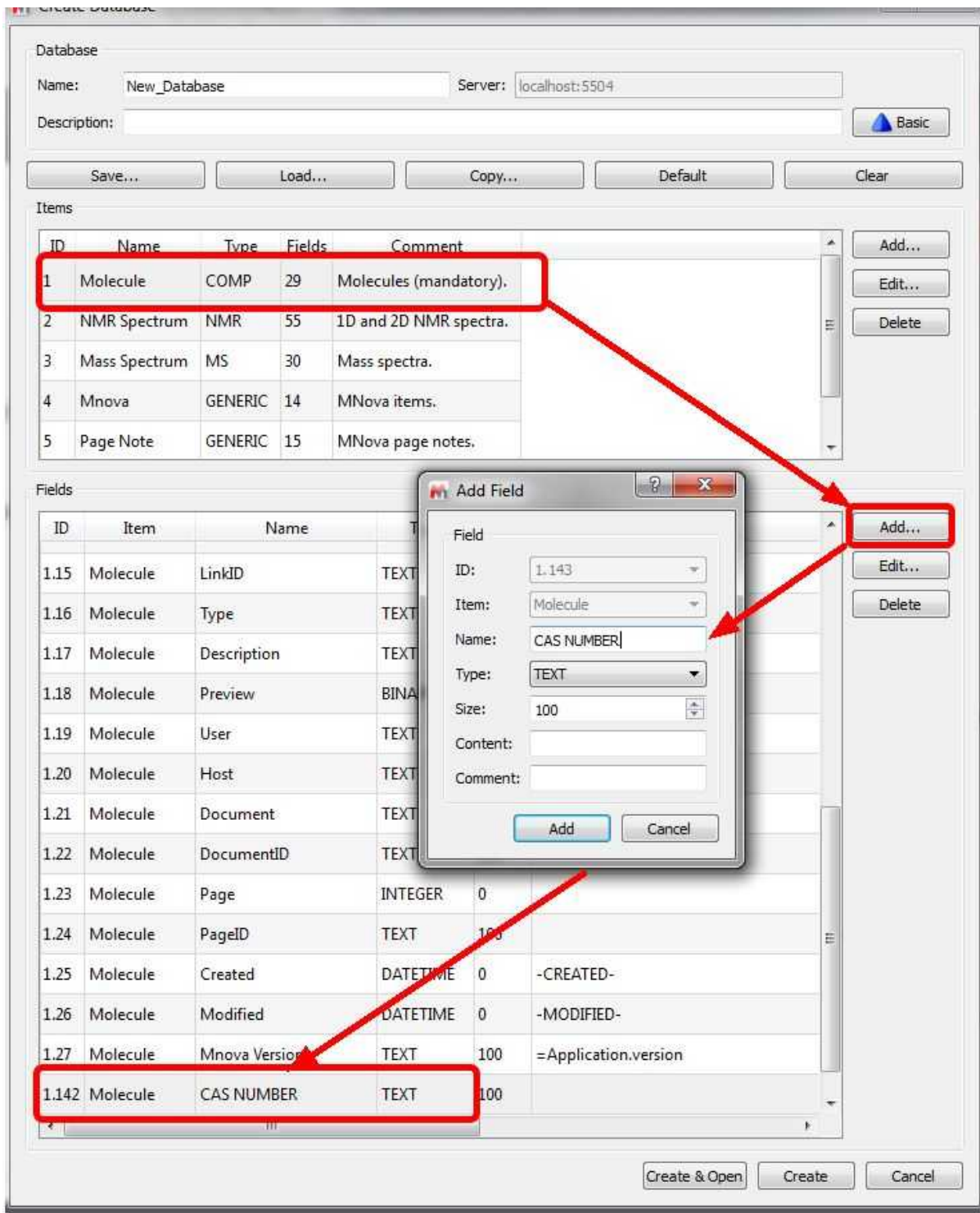

Once you have selected the desired items, click on the 'Create&Open button.

If you want to delete any existing database, just follow the menu 'Database/Delete Database' and select the undesired database in the window displayed:

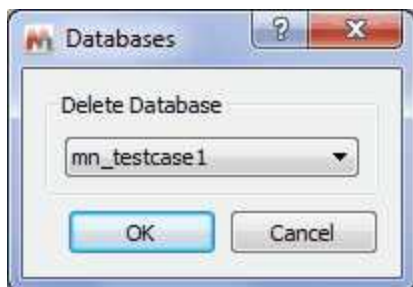

15.8.1 Create custom fields

It is possible create custom text fields by using a layout template. Let's see an example which you can download from [here](#)

First of all, you will need to create a new Database with the new text fields. You can do it by following the menu 'Database/Create Database/Advanced/Load' and select the XML which is on the file that you downloaded above (or you can add the new text fields that you want). This will add two new text files ('Project Name' and 'Analysis Comments') to the Database. Click on the 'Create&open' button to generate the new Database:

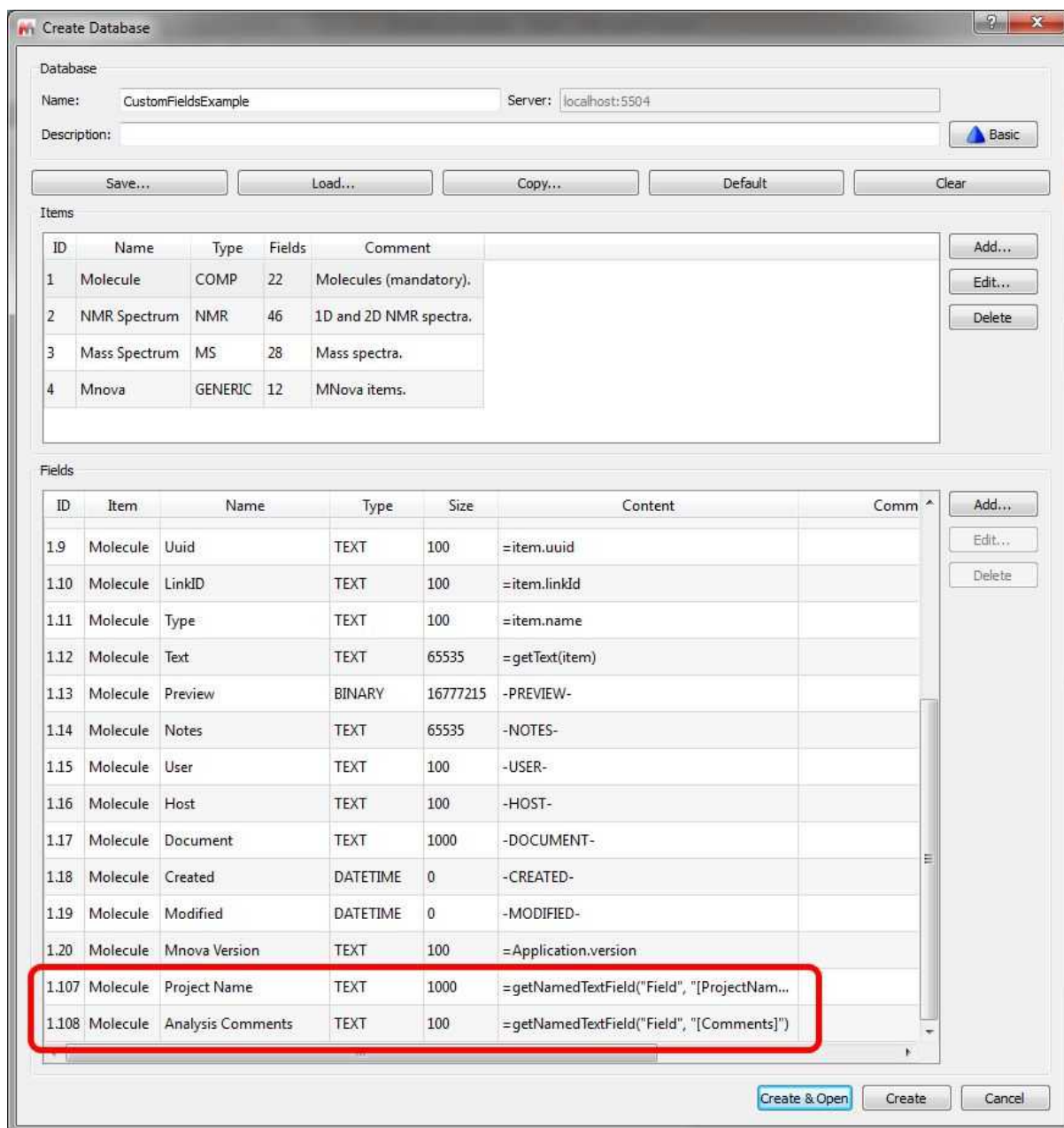

Then, you will need to create a [layout template](#) (in the example the template is called "LayoutOrig.mnova").

Here you can see a layout template with 5 pages (molecule, 1H-NMR, 13C-NMR, 2D-NMR and MS):

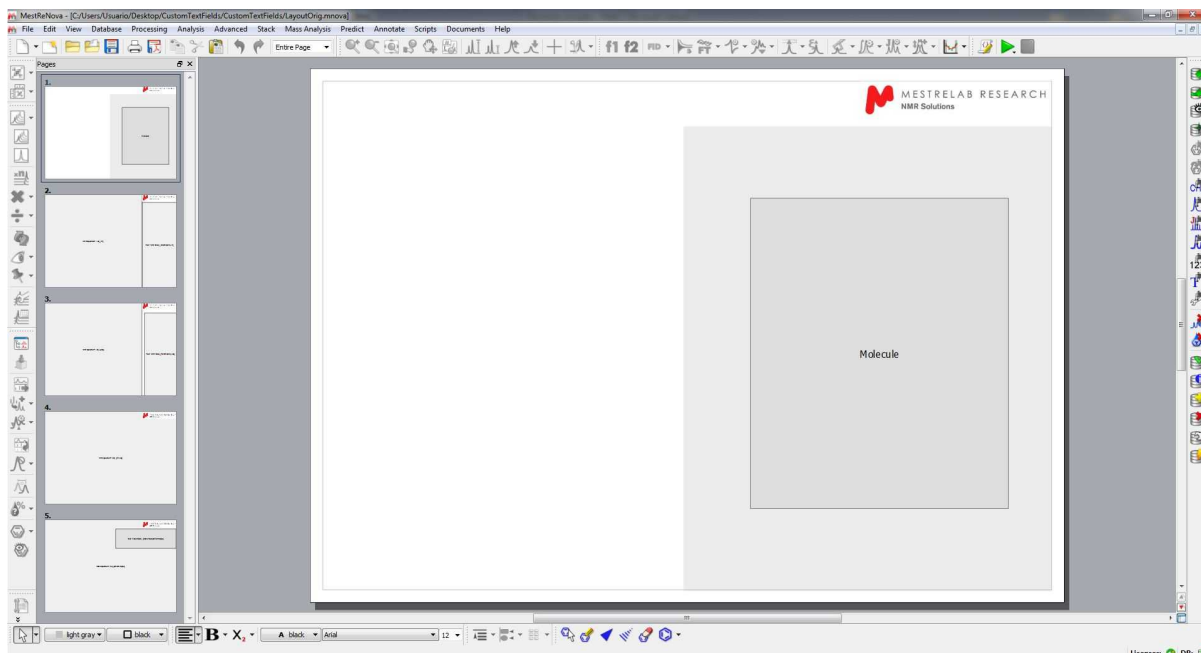

Then, run the script called "addNamedFields.qs". This will add two named text fields [ProjectName] and [Comments] to the layout:

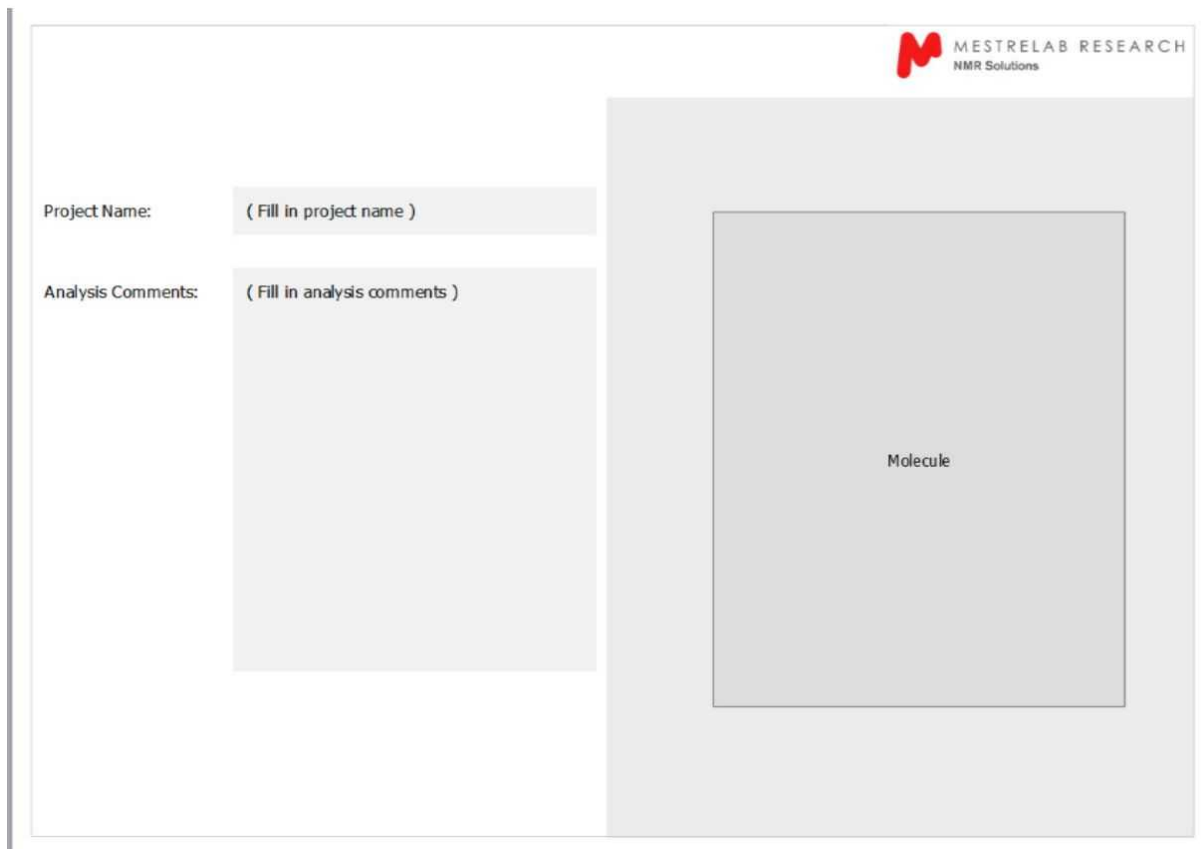

Then save the results as "LayoutWithFields.mnova" by following the menu 'File/Save As'.

Finally apply the layout template over your datasets, fill the text fields manually and save the documents to the Database (by following the menu 'Database/Save').

To display the new custom fields after a search, go to the DBBrowser and add the new fields to views as desired and save the configuration by following the menu "Configure/Save Settings As":

The screenshot displays the Mestrelab software interface. On the left, the 'Fields' panel is open, showing a list of fields with their content. The 'Analysis Comments' field is highlighted with a red box, and the 'Project Name' field is also highlighted with a red box. The main window shows a chemical structure of a molecule, an NMR spectrum, and a mass spectrum. The NMR spectrum shows peaks at various chemical shifts, and the mass spectrum shows a base peak at m/z 308. The 'Item List' panel on the right shows a list of records with columns for Record, Item Type, and Item Number.

It will be also possible to create **mandatory fields** in order to save to the Database, You will find an example script called "dbMandatoryFieldsExample1.qs" into the examples installation folder of Mnova. Save this script into one of your 'Scripts directories' (Edit/Preferences/Scripting), restart Mnova and then create a new database with two added custom fields "Project" and "NotebookRef" in the Molecule item type:

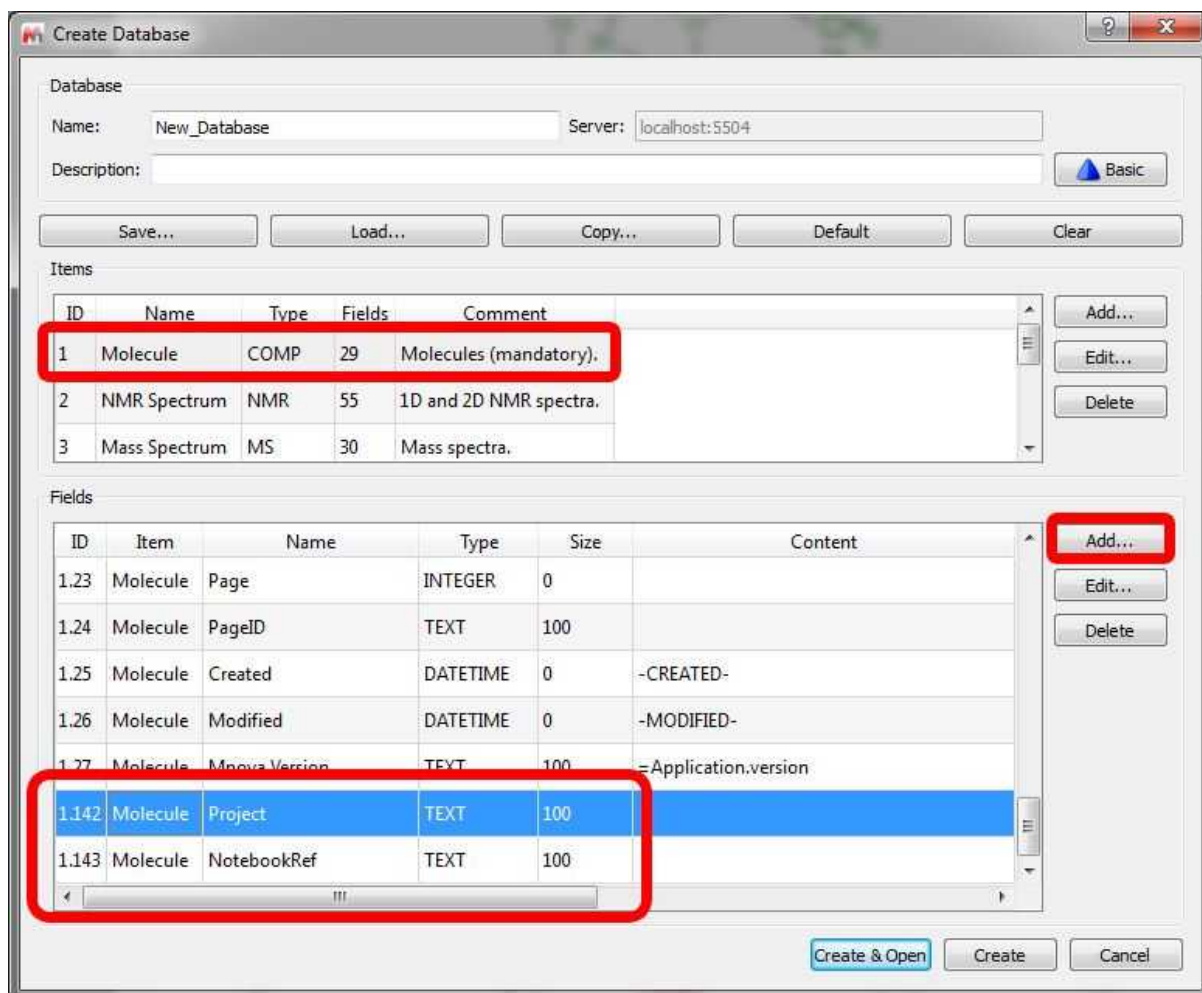

Next, save any dataset to the new database and a dialog asking for the content of the mandatory fields will be shown with each save operation:

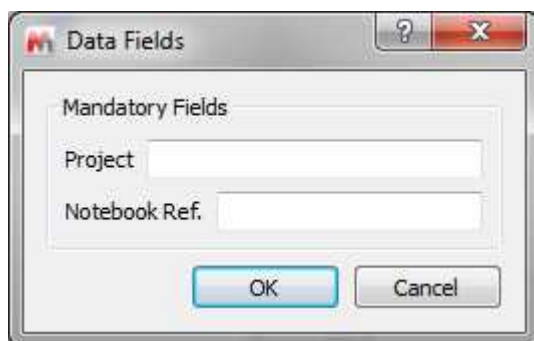

15.9 Mnova DB scripts

The user will find in the Scripts menu some useful scripts for the Database plugin:

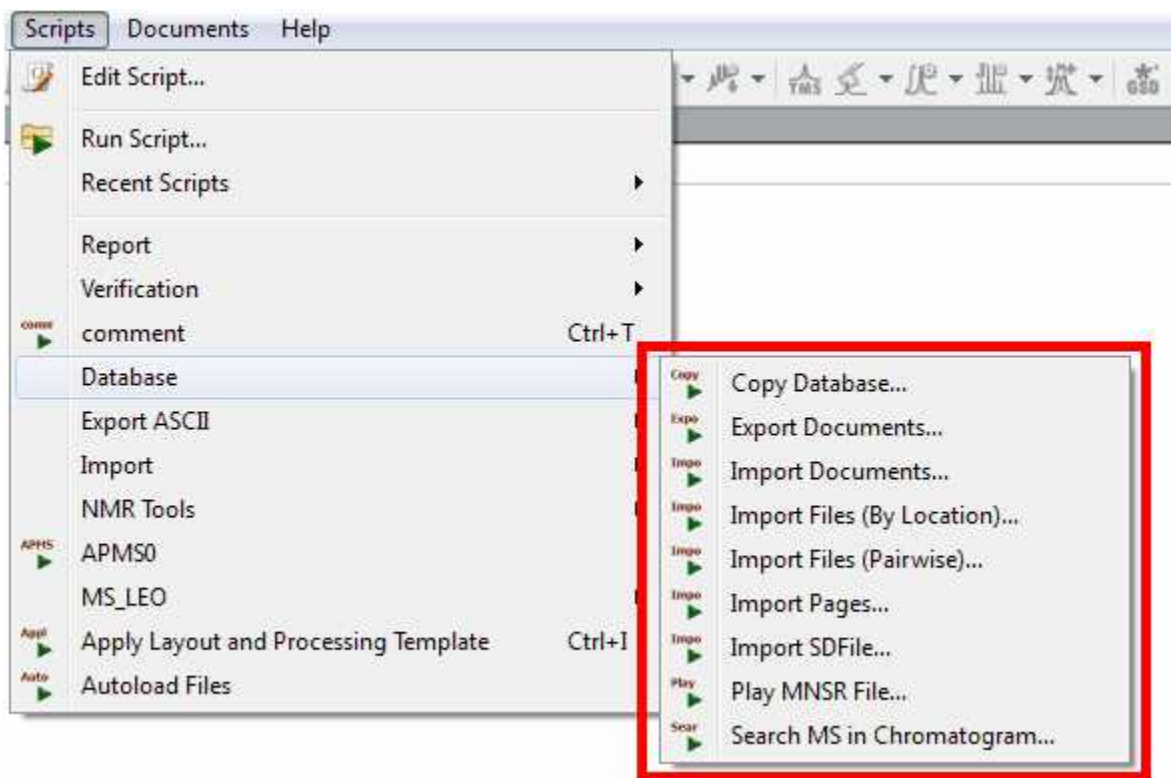

The **Copy Database** script will allow you to export databases to any destination:

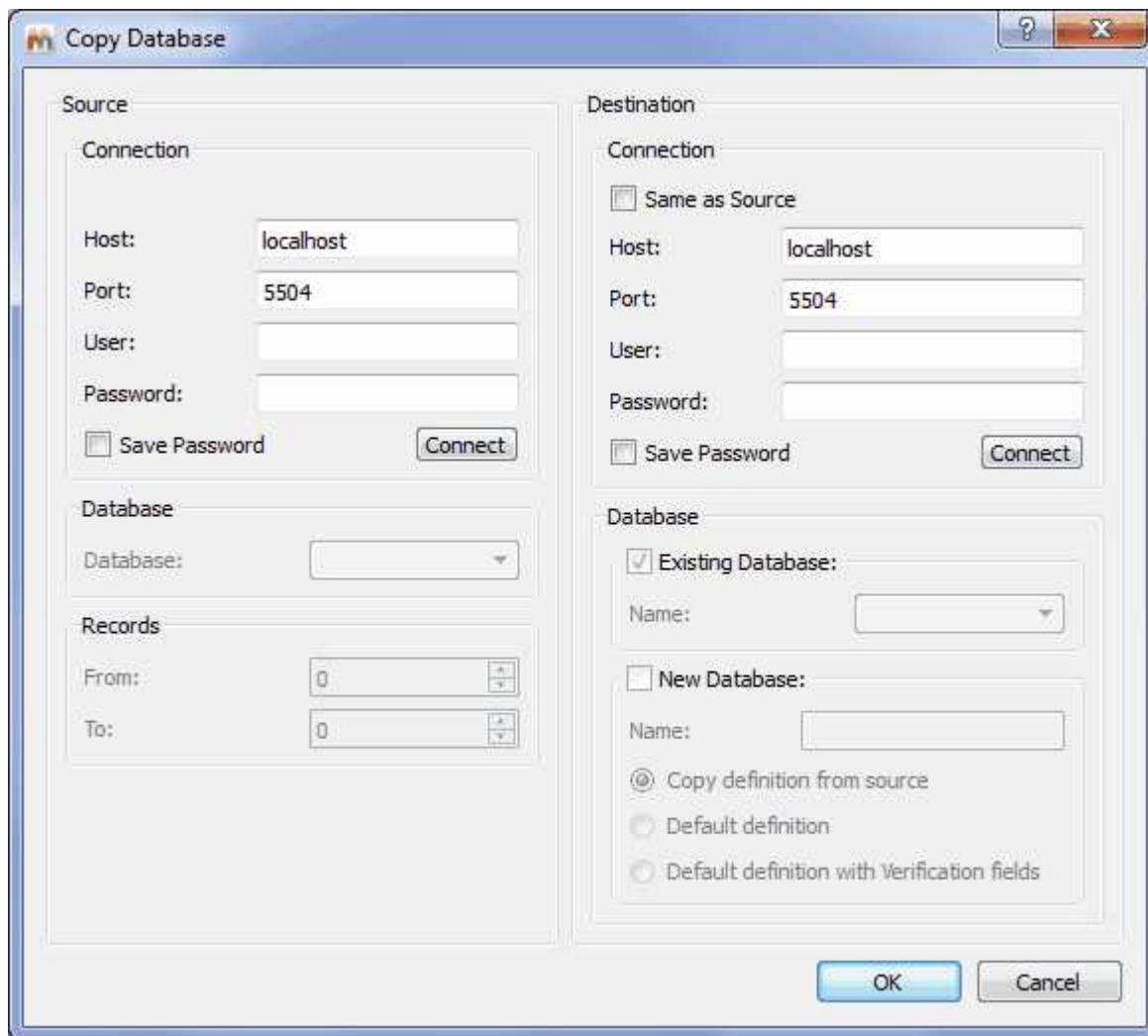

The **Export Documents** scripts will be very useful to export all the selected compounds of the Database as Mnova documents into the desired directory:



The **Import Documents** script will allow you to save to the Database Mnova documents from a selected directory. This script looks for Mnova documents on disk, everything in the same document goes into the same database record:



The **Import Files (by Location)** will save to the database the desired type of files from a selected directory:

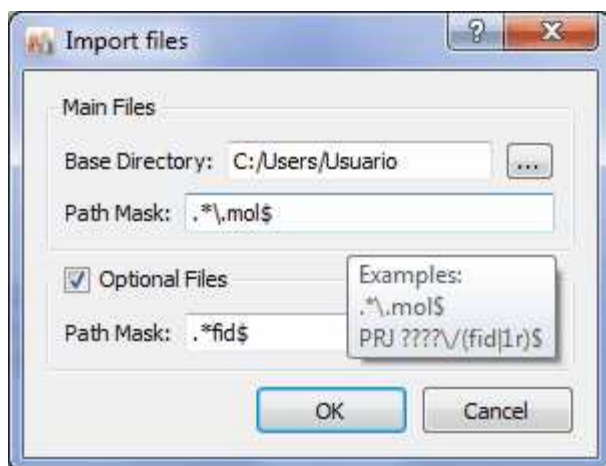

For the 'Path Mask'; you can use wildcards, so this could be, for example, `*\\.mol$`; or just `*fid$` and click 'OK'. The \$ symbol means in `*fid$` that it will search for the FIDs that are stored at the end of the folders structure (valid for those cases where all the spectra of a given molecule are grouped in the same folder).

This script looks for main files matching the given path mask in the specified folder. Then, for each main file found, it looks for optional files according to the second path mask **relative to each main file location**. Depending on your situation, main files could be molfiles and optional files spectra, or vice versa. E.g. You have many spectra (main files), and for some of them you have a molfile (optional files). Or, you have molfiles (main files), and for each molfile you have zero, one, or several spectra (optional files).

E.g:

```

\Data\ABC123\ABC123.mol
\Data\ABC123\NMR\XBlah.fid
\Data\ABC124\Molecule.mol
\Data\ABC124\NMR\124.fid
\Data\ABC125\Whatever.mol
\Data\ABC125\NMR\Any.fid

```

The **Import Files (pairwise)** will import pairs of molecules and spectra (first spectrum with the first molecule in the applicable folder; second spectrum with second molecule and so on...) and will save them into the Database. Please bear in mind that you must have the same number of molecules and spectra.

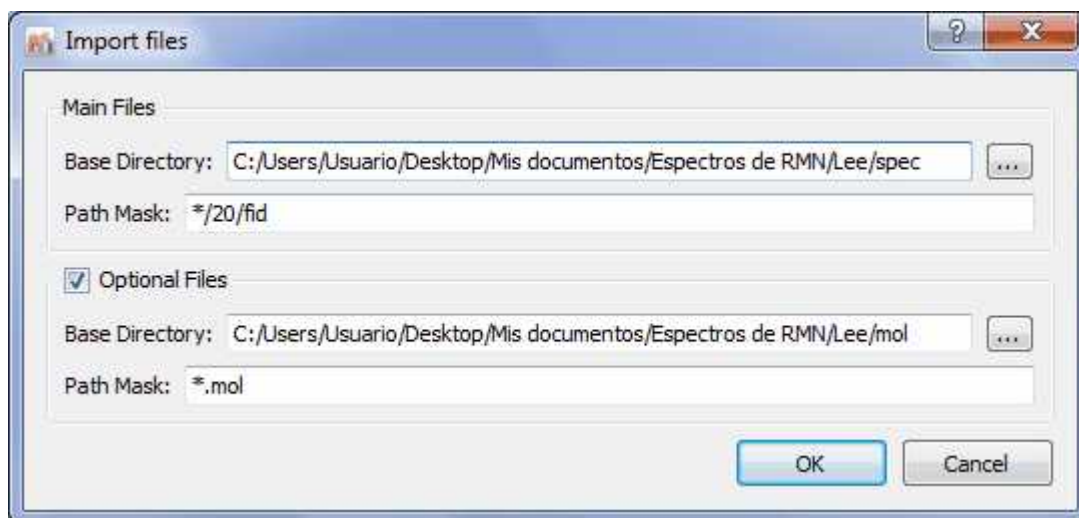

You can use wildcards for the 'Path Mask', so this could be, for example, */10/pdata/1r, or just */fid, or */ser. Finally click 'OK' and all the selected spectra and molecules will be saved in the database.

It works exactly as the Multi-Open script: You give it two path masks and it will look for files of each type according to the corresponding path mask. Files are associated to each other by the order in which they are found. So there needs to be a 1-to-1 correspondence between spectra and molecule files. The order in which they are found is determined by the file names. You would use this script if you have two folders (one for molecules and another for spectra) and the files can be associated with each other via the file name.

E.g:

```

\Data\Molecules\ABC123.mol
\Data\Molecules\ABC124.mol
\Data\Molecules\ABC125.mol
\Data\Spectra\NMR\ABC123.fid
\Data\Spectra\NMR\ABC124.fid
\Data\Spectra\NMR\ABC125.fid

```

The **Import Pages** script will save all the pages in the current document to the current Mnova Database:

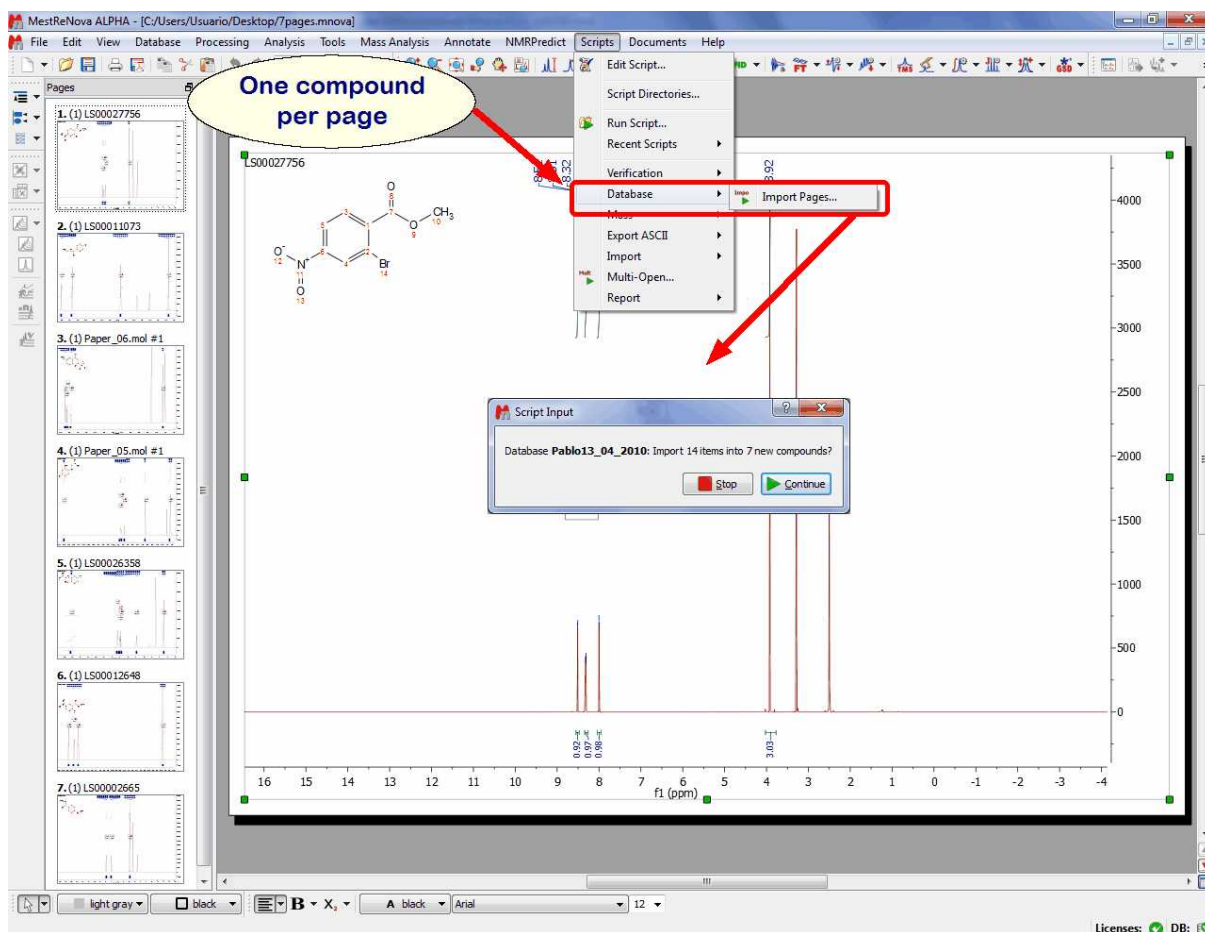

This script goes through the currently open Mnova document, creates a new record for each page, everything on the same page goes into the same database record.

The **'ImportSD File'** script will allow you to import to your Database the molecules contained in a SDF file.

Mnsr files can be played to the MnDB server either via the Mnova client (Scripts/Database/Play Mnsr File), or via the MnDB test client.

The **"SDFfile to definition"** script takes an SDFfile and outputs a database definition .xml file. The Database definition .xml file can then be used to create new databases into which the SDFfile which can be imported by using Scripts/Database/Import SDFfile, preserving 'all tags' and data. So, if you want to import all the tags of your SDF file into a Database, you will need to use this script.

The Search MS in Chromatogram script, will search for all the mass spectra under each TIC peak. You will only need to load your GC/MS dataset and after having run the script, a dialog box will be displayed asking for the options for matching MS peaks:

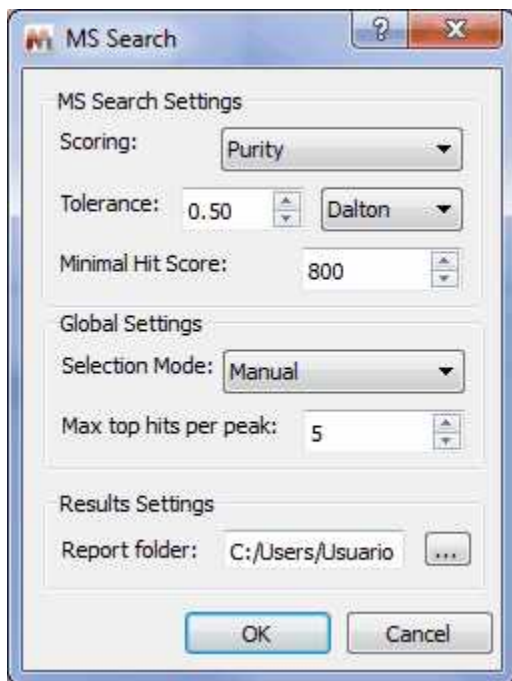

You will need to select the maximum number of top hits to report for each peak (default: top 5).

Clicking on OK, the script will get the mass spec under each TIC peak (depending on the current setting of the Selection Mode: Manual, Peak, or Peak with Background Subtraction), do peak picking, and search the peaks against the selected DB.

Thank you!

Thank you for reading this manual, and for purchasing this release version of Mnova. We will be very keen to read your feedback on the application, to hear about any bugs you may find and to also listen to any additional ideas or suggestions you may have.

Please remember that you can send all those, and any queries about the software, or requests for help, to:

support@mestrelab.com

Keep checking our web site (www.mestrelab.com) for additional information on our range of software packages, and for news on our company.